

MPI: A Message-Passing Interface Standard

Version 3.0

(Draft)

Unofficial, for comment only

Message Passing Interface Forum

July 13, 2012

ticket0.

ticket0. 1
2
3
4
5
ticket0. 6
7
8
9
10
11
12
13
14
ticket0. 15
16
17
18
19
20
21
22
23
24
25
26
27
28
29
30
31
32
33
34
35
36
37
38
39
40
41
42
43
44

This document describes the Message-Passing Interface (MPI) standard, version [2.2]3.0. The MPI standard includes point-to-point message-passing, collective communications, group and communicator concepts, process topologies, environmental management, process creation and management, one-sided communications, extended collective operations, external interfaces, I/O, some miscellaneous topics, and a profiling interface. Language bindings for C, C++ and Fortran are defined.

[Technically, this version of the standard is based on “MPI: A Message-Passing Interface Standard, version 2.1, June 23, 2008. The MPI Forum added seven new routines and a number of enhancements and clarifications to the standard.]

Historically, the evolution of the standards is from MPI-1.0 (June 1994) to MPI-1.1 (June 12, 1995) to MPI-1.2 (July 18, 1997), with several clarifications and additions and published as part of the MPI-2 document, to MPI-2.0 (July 18, 1997), with new functionality, to MPI-1.3 (May 30, 2008), combining for historical reasons the documents 1.1 and 1.2 and some errata documents to one combined document, and to MPI-2.1 (June 23, 2008), combining the previous documents. [This version, MPI-2.2, is based on MPI-2.1 and provides additional clarifications and errata corrections as well as a few enhancements.] Version MPI-2.2 (September 2009) added additional clarifications and seven new routines. This version, MPI-3.0, is an extension of MPI-2.2.

©1993, 1994, 1995, 1996, 1997, 2008, 2009, 2010 University of Tennessee, Knoxville, Tennessee. Permission to copy without fee all or part of this material is granted, provided the University of Tennessee copyright notice and the title of this document appear, and notice is given that copying is by permission of the University of Tennessee.

1
2 ticket0.
3
4
5
6
7
8
9
10
11
12 ticket0.
13 ticket0.
14 ticket0.
15
16
17
18
19
20
21
22
23
24
25
26
27
28
29
30
31 ticket0.
32
33
34
35 ticket0.
36
37
38
39
40
41
42
43 ticket0.
44 ticket0.
45
46 ticket0.
47
48

Version 3.0: xx, x, 2011. Coincident with the development of MPI-2.2, the MPI Forum began discussions of a major extension to MPI. This document contains the MPI-3 Standard. This draft version of the MPI-3 standard extends the collective operations by including nonblocking versions. Unlike MPI-2.2, this standard is considered a major update to the MPI standard. As with previous versions, new features have been adopted only when there were compelling needs for the users. Some features, however, may have more than a minor impact on existing MPI implementations.

Version 2.2: September 4, 2009. This document contains mostly corrections and clarifications to the [MPI 2.1]MPI-2.1 document. A few extensions have been added; however all correct [MPI 2.1]MPI-2.1 programs are correct [MPI 2.2]MPI-2.2 programs. New features were adopted only when there were compelling needs for users, open source implementations, and minor impact on existing MPI implementations.

Version 2.1: June 23, 2008. This document combines the previous documents MPI-1.3 (May 30, 2008) and MPI-2.0 (July 18, 1997). Certain parts of MPI-2.0, such as some sections of Chapter 4, Miscellany, and Chapter 7, Extended Collective Operations have been merged into the Chapters of MPI-1.3. Additional errata and clarifications collected by the MPI Forum are also included in this document.

Version 1.3: May 30, 2008. This document combines the previous documents MPI-1.1 (June 12, 1995) and the MPI-1.2 Chapter in MPI-2 (July 18, 1997). Additional errata collected by the MPI Forum referring to MPI-1.1 and MPI-1.2 are also included in this document.

Version 2.0: July 18, 1997. Beginning after the release of MPI-1.1, the MPI Forum began meeting to consider corrections and extensions. MPI-2 has been focused on process creation and management, one-sided communications, extended collective communications, external interfaces and parallel I/O. A miscellany chapter discusses items that [don't]do not fit elsewhere, in particular language interoperability.

Version 1.2: July 18, 1997. The MPI-2 Forum introduced MPI-1.2 as Chapter 3 in the standard ["]“MPI-2: Extensions to the Message-Passing Interface”, July 18, 1997. This section contains clarifications and minor corrections to Version 1.1 of the MPI Standard. The only new function in MPI-1.2 is one for identifying to which version of the MPI Standard the implementation conforms. There are small differences between MPI-1 and MPI-1.1. There are very few differences between MPI-1.1 and MPI-1.2, but large differences between MPI-1.2 and MPI-2.

Version 1.1: June, 1995. Beginning in March, 1995, the Message-Passing Interface Forum reconvened to correct errors and to make clarifications in the MPI document of May 5, 1994, referred to below as Version 1.0. These discussions resulted in Version 1.1[which is this document]. The changes from Version 1.0 are minor. A version of this document with all changes marked is available. [This paragraph is an example of a change.]

1 Version 1.0: May, 1994. The Message-Passing Interface Forum (MPIF), with participation
ticket0. 2 from over 40 organizations, has been meeting since January 1993 to discuss and to define a
3 set of library interface standards for message passing. MPIF is not sanctioned or supported
4 by any official standards organization.

5 The goal of the Message-Passing Interface, simply stated, is to develop a widely used
6 standard for writing message-passing programs. As such the interface should establish a
ticket0. 7 practical, portable, efficient, and flexible standard for message-passing.

8 [This is the final report, Version 1.0, of the Message-Passing Interface Forum.]This
9 document contains all the technical features proposed for the interface. This copy of the
10 draft was processed by L^AT_EX on May 5, 1994.

11 Please send comments on MPI to mpi-comments@mpi-forum.org. Your comment will
12 be forwarded to MPI Forum committee members who will attempt to respond.

13
14
15
16
17
18
19
20
21
22
23
24
25
26
27
28
29
30
31
32
33
34
35
36
37
38
39
40
41
42
43
44
45
46
47
48

Contents

Acknowledgments	ix
1 Introduction to MPI	1
1.1 Overview and Goals	1
1.2 Background of MPI-1.0	2
1.3 Background of MPI-1.1, MPI-1.2, and MPI-2.0	3
1.4 Background of MPI-1.3 and MPI-2.1	3
1.5 Background of MPI-2.2	4
1.6 Background of MPI-3.0	4
1.7 Who Should Use This Standard?	5
1.8 What Platforms Are Targets For Implementation?	5
1.9 What Is Included In The Standard?	5
1.10 What Is Not Included In The Standard?	6
1.11 Organization of this Document	6
2 MPI Terms and Conventions	9
2.1 Document Notation	9
2.2 Naming Conventions	9
2.3 Procedure Specification	10
2.4 Semantic Terms	11
2.5 Data Types	12
2.5.1 Opaque Objects	12
2.5.2 Array Arguments	15
2.5.3 State	15
2.5.4 Named Constants	15
2.5.5 Choice	16
2.5.6 Addresses	17
2.5.7 File Offsets	17
2.5.8 Counts	17
2.6 Language Binding	17
2.6.1 Deprecated and Removed Names and Functions	18
2.6.2 Fortran Binding Issues	18
2.6.3 C Binding Issues	20
2.6.4 C++ Binding Issues	20
2.6.5 Functions and Macros	23
2.7 Processes	23
2.8 Error Handling	24

ticket0.341.

2.9	Implementation Issues	25
2.9.1	Independence of Basic Runtime Routines	25
2.9.2	Interaction with Signals	26
2.10	Examples	26
3	Point-to-Point Communication	27
3.1	Introduction	27
3.2	Blocking Send and Receive Operations	28
3.2.1	Blocking Send	28
3.2.2	Message Data	29
3.2.3	Message Envelope	31
3.2.4	Blocking Receive	32
3.2.5	Return Status	34
3.2.6	Passing MPI_STATUS_IGNORE for Status	36
3.3	Data Type Matching and Data Conversion	37
3.3.1	Type Matching Rules	37
	Type MPI_CHARACTER	39
3.3.2	Data Conversion	40
3.4	Communication Modes	41
3.5	Semantics of Point-to-Point Communication	46
3.6	Buffer Allocation and Usage	49
3.6.1	Model Implementation of Buffered Mode	51
3.7	Nonblocking Communication	52
3.7.1	Communication Request Objects	53
3.7.2	Communication Initiation	54
3.7.3	Communication Completion	58
3.7.4	Semantics of Nonblocking Communications	61
3.7.5	Multiple Completions	63
3.7.6	Non-destructive Test of status	70
3.8	Probe and Cancel	71
3.8.1	Probe	71
3.8.2	Matching Probe	75
3.8.3	Matched Receives	76
3.8.4	Cancel	78
3.9	Persistent Communication Requests	80
3.10	Send-Receive	86
3.11	Null Processes	89
4	Datatypes	91
4.1	Derived Datatypes	91
4.1.1	Type Constructors with Explicit Addresses	93
4.1.2	Datatype Constructors	93
4.1.3	Subarray Datatype Constructor	103
4.1.4	Distributed Array Datatype Constructor	105
4.1.5	Address and Size Functions	110
4.1.6	Lower-Bound and Upper-Bound Markers	112
4.1.7	Extent and Bounds of Datatypes	114
4.1.8	True Extent of Datatypes	116

4.1.9	Commit and Free	117
4.1.10	Duplicating a Datatype	119
4.1.11	Use of General Datatypes in Communication	119
4.1.12	Correct Use of Addresses	123
4.1.13	Decoding a Datatype	124
4.1.14	Examples	131
4.2	Pack and Unpack	140
4.3	Canonical MPI_PACK and MPI_UNPACK	147
5	Collective Communication	151
5.1	Introduction and Overview	151
5.2	Communicator Argument	154
5.2.1	Specifics for Intracommunicator Collective Operations	154
5.2.2	Applying Collective Operations to Intercommunicators	155
5.2.3	Specifics for Intercommunicator Collective Operations	156
5.3	Barrier Synchronization	157
5.4	Broadcast	158
5.4.1	Example using MPI_BCAST	159
5.5	Gather	160
5.5.1	Examples using MPI_GATHER, MPI_GATHERV	163
5.6	Scatter	170
5.6.1	Examples using MPI_SCATTER, MPI_SCATTERV	173
5.7	Gather-to-all	176
5.7.1	Example using MPI_ALLGATHER	179
5.8	All-to-All Scatter/Gather	180
5.9	Global Reduction Operations	185
5.9.1	Reduce	186
5.9.2	Predefined Reduction Operations	188
5.9.3	Signed Characters and Reductions	190
5.9.4	MINLOC and MAXLOC	191
5.9.5	User-Defined Reduction Operations	195
	Example of User-defined Reduce	198
5.9.6	All-Reduce	199
5.9.7	Process-[l]Local [r]Reduction	201
5.10	Reduce-Scatter	202
5.10.1	MPI_REDUCE_SCATTER_BLOCK	203
5.10.2	MPI_REDUCE_SCATTER	204
5.11	Scan	206
5.11.1	Inclusive Scan	206
5.11.2	Exclusive Scan	207
5.11.3	Example using MPI_SCAN	208
5.12	Nonblocking Collective Operations	209
5.12.1	Nonblocking Barrier Synchronization	211
5.12.2	Nonblocking Broadcast	212
	Example using MPI_IBCAST	213
5.12.3	Nonblocking Gather	213
5.12.4	Nonblocking Scatter	215
5.12.5	Nonblocking Gather-to-all	217

ticket0.
ticket0.

5.12.6	Nonblocking All-to-All Scatter/Gather	219
5.12.7	Nonblocking Reduce	223
5.12.8	Nonblocking All-Reduce	224
5.12.9	Nonblocking Reduce-Scatter with Equal Blocks	225
5.12.10	Nonblocking Reduce-Scatter	226
5.12.11	Nonblocking Inclusive Scan	227
5.12.12	Nonblocking Exclusive Scan	228
5.13	Correctness	228
6	Groups, Contexts, Communicators, and Caching	237
6.1	Introduction	237
6.1.1	Features Needed to Support Libraries	237
6.1.2	MPI’s Support for Libraries	238
6.2	Basic Concepts	240
6.2.1	Groups	240
6.2.2	Contexts	240
6.2.3	Intra-Communicators	241
6.2.4	Predefined Intra-Communicators	241
6.3	Group Management	242
6.3.1	Group Accessors	242
6.3.2	Group Constructors	244
6.3.3	Group Destructors	249
6.4	Communicator Management	250
6.4.1	Communicator Accessors	250
6.4.2	Communicator Constructors	252
6.4.3	Communicator Destructors	261
6.5	Motivating Examples	261
6.5.1	Current Practice #1	261
6.5.2	Current Practice #2	262
6.5.3	(Approximate) Current Practice #3	263
6.5.4	Example #4	264
6.5.5	Library Example #1	265
6.5.6	Library Example #2	266
6.6	Inter-Communication	268
6.6.1	Inter-communicator Accessors	270
6.6.2	Inter-communicator Operations	272
6.6.3	Inter-Communication Examples	274
	Example 1: Three-Group “Pipeline”	274
	Example 2: Three-Group “Ring”	276
6.7	Caching	277
6.7.1	Functionality	278
6.7.2	Communicators	279
6.7.3	Windows	285
6.7.4	Datatypes	289
6.7.5	Error Class for Invalid Keyval	293
6.7.6	Attributes Example	293
6.8	Naming Objects	295
6.9	Formalizing the Loosely Synchronous Model	299

6.9.1	Basic Statements	300	
6.9.2	Models of Execution	300	
	Static communicator allocation	300	
	Dynamic communicator allocation	300	
	The General [c]Case	301	ticket0.
7	Process Topologies	303	
7.1	Introduction	303	
7.2	Virtual Topologies	304	
7.3	Embedding in MPI	304	
7.4	Overview of the Functions	304	
7.5	Topology Constructors	306	
7.5.1	Cartesian Constructor	306	
7.5.2	Cartesian Convenience Function: MPI_DIMS_CREATE	307	
7.5.3	[General (Graph)]GraphConstructor	308	ticket259.
7.5.4	[Distributed (Graph)]Distributed GraphConstructor	310	ticket259.
7.5.5	Topology Inquiry Functions	317	
7.5.6	Cartesian Shift Coordinates	325	
7.5.7	Partitioning of Cartesian [s]Structures	327	ticket0.
7.5.8	Low-Level Topology Functions	328	
7.6	Neighborhood Collective Communication on Process Topologies	330	
7.6.1	Neighborhood Gather	330	
7.6.2	Neighbor Alltoall	334	
7.7	Nonblocking Neighborhood Communication on Process Topologies	339	
7.7.1	Nonblocking Neighborhood Gather	340	
7.7.2	Nonblocking Neighborhood Alltoall	342	
7.8	An Application Example	345	
8	MPI Environmental Management	351	
8.1	Implementation Information	351	
8.1.1	Version Inquiries	351	
8.1.2	Environmental Inquiries	353	
	Tag Values	353	
	Host Rank	353	
	IO Rank	354	
	Clock Synchronization	354	
	Inquire Processor Name	354	ticket255.
8.2	Memory Allocation	355	
8.3	Error Handling	358	
8.3.1	Error Handlers for Communicators	360	
8.3.2	Error Handlers for Windows	362	
8.3.3	Error Handlers for Files	364	
8.3.4	Freeing Errorhandlers and Retrieving Error Strings	366	
8.4	Error Codes and Classes	367	
8.5	Error Classes, Error Codes, and Error Handlers	369	
8.6	Timers and Synchronization	374	
8.7	Startup	375	
8.7.1	Allowing User Functions at Process Termination	380	

8.7.2	Determining Whether MPI Has Finished	381
8.8	Portable MPI Process Startup	381
9	The Info Object	385
10	Process Creation and Management	391
10.1	Introduction	391
10.2	The Dynamic Process Model	392
10.2.1	Starting Processes	392
10.2.2	The Runtime Environment	392
10.3	Process Manager Interface	394
10.3.1	Processes in MPI	394
10.3.2	Starting Processes and Establishing Communication	394
10.3.3	Starting Multiple Executables and Establishing Communication	399
10.3.4	Reserved Keys	402
10.3.5	Spawn Example	403
	Manager-worker Example [5]Using MPI_COMM_SPAWN.	403
10.4	Establishing Communication	405
10.4.1	Names, Addresses, Ports, and All That	405
10.4.2	Server Routines	407
10.4.3	Client Routines	409
10.4.4	Name Publishing	410
10.4.5	Reserved Key Values	413
10.4.6	Client/Server Examples	413
	Simplest Example — Completely Portable.	413
	Ocean/Atmosphere - Relies on Name Publishing	414
	Simple Client-Server Example.	414
10.5	Other Functionality	415
10.5.1	Universe Size	415
10.5.2	Singleton MPI_INIT	416
10.5.3	MPI_APPNUM	417
10.5.4	Releasing Connections	418
10.5.5	Another Way to Establish MPI Communication	419
11	One-Sided Communications	423
11.1	Introduction	423
11.2	Initialization	424
11.2.1	Window Creation	425
11.2.2	Window That Allocates Memory	427
11.2.3	Window That Allocates Shared Memory	429
11.2.4	Window of Dynamically Attached Memory	431
11.2.5	Window Destruction	434
11.2.6	Window Attributes	435
11.3	Communication Calls	437
11.3.1	Put	438
11.3.2	Get	440
11.3.3	Examples for Communication Calls	441
11.3.4	Accumulate Functions	443

ticket0.

ticket270.

Accumulate Function	443
Get Accumulate Function	446
Fetch and Op Function	447
Compare and Swap Function	448
11.3.5 Request-based RMA Communication Operations	450
11.4 Memory Model	455
11.5 Synchronization Calls	456
11.5.1 Fence	460
11.5.2 General Active Target Synchronization	461
11.5.3 Lock	466
11.5.4 Flush and Sync	469
11.5.5 Assertions	471
11.5.6 Miscellaneous Clarifications	472
11.6 Error Handling	472
11.6.1 Error Handlers	472
11.6.2 Error Classes	473
11.7 Semantics and Correctness	473
11.7.1 Atomicity	482
11.7.2 Ordering	482
11.7.3 Progress	483
11.7.4 Registers and Compiler Optimizations	485
11.8 Examples	486
12 External Interfaces	495
12.1 Introduction	495
12.2 Generalized Requests	495
12.2.1 Examples	500
12.3 Associating Information with Status	502
12.4 MPI and Threads	504
12.4.1 General	505
12.4.2 Clarifications	506
12.4.3 Initialization	507
13 I/O	513
13.1 Introduction	513
13.1.1 Definitions	513
13.2 File Manipulation	515
13.2.1 Opening a File	515
13.2.2 Closing a File	518
13.2.3 Deleting a File	518
13.2.4 Resizing a File	519
13.2.5 Preallocating Space for a File	520
13.2.6 Querying the Size of a File	521
13.2.7 Querying File Parameters	521
13.2.8 File Info	523
Reserved File Hints	524
13.3 File Views	526
13.4 Data Access	529

13.4.1	Data Access Routines	529
	Positioning	530
	Synchronism	530
	Coordination	531
	Data Access Conventions	531
13.4.2	Data Access with Explicit Offsets	532
13.4.3	Data Access with Individual File Pointers	536
13.4.4	Data Access with Shared File Pointers	544
	Noncollective Operations	545
	Collective Operations	547
	Seek	549
13.4.5	Split Collective Data Access Routines	550
13.5	File Interoperability	558
13.5.1	Datatypes for File Interoperability	560
13.5.2	External Data Representation: “external32”	562
13.5.3	User-Defined Data Representations	563
	Extent Callback	565
	Datarep Conversion Functions	566
13.5.4	Matching Data Representations	568
13.6	Consistency and Semantics	569
13.6.1	File Consistency	569
13.6.2	Random Access vs. Sequential Files	572
13.6.3	Progress	572
13.6.4	Collective File Operations	572
13.6.5	Type Matching	573
13.6.6	Miscellaneous Clarifications	573
13.6.7	MPI_Offset Type	573
13.6.8	Logical vs. Physical File Layout	573
13.6.9	File Size	574
13.6.10	Examples	574
	Asynchronous I/O	577
13.7	I/O Error Handling	578
13.8	I/O Error Classes	579
13.9	Examples	579
13.9.1	Double Buffering with Split Collective I/O	579
13.9.2	Subarray Filetype Constructor	582
14	Tool Support	586
14.1	Introduction	586
14.2	Profiling Interface	586
14.2.1	Requirements	586
14.2.2	Discussion	587
14.2.3	Logic of the Design	588
14.2.4	Miscellaneous Control of Profiling	588
14.2.5	Profiler Implementation □ Example	589
14.2.6	MPI Library Implementation □ Example	589
	Systems with Weak Symbols	590
	Systems Without Weak Symbols	590

ticket266.
ticket266.

14.2.7	Complications	591
	Multiple Counting	591
	Linker Oddities	591
	Fortran Support Methods	591
14.2.8	Multiple Levels of Interception	591
14.3	The MPI Tool Information Interface	592
14.3.1	Verbosity Levels	593
14.3.2	Binding MPI Tool Information Interface Variables to MPI Objects	594
14.3.3	Convention for Returning Strings	594
14.3.4	Initialization and Finalization	595
14.3.5	Datatype System	596
14.3.6	Control Variables	598
	Control Variable Query Functions	598
	Example: Printing All Control Variables	600
	Handle Allocation and Deallocation	601
	Control Variable Access Functions	603
	Example: Reading the Value of a Control Variable	603
14.3.7	Performance Variables	604
	Performance Variable Classes	604
	Performance Variable Query Functions	607
	Performance Experiment Sessions	609
	Handle Allocation and Deallocation	610
	Starting and Stopping of Performance Variables	611
	Performance Variable Access Functions	612
	Example: Tool to Detect Receives with Long Unexpected Message Queues	614
14.3.8	Variable Categorization	616
14.3.9	Return Codes for the MPI tool information interface	619
14.3.10	Profiling Interface	619
15	Deprecated Functions	621
15.1	Deprecated since MPI-2.0	621
15.2	Deprecated since MPI-2.2	628
15.3	Deprecated since MPI-3.0	629
16	Language Bindings	631
16.1	C++	631
16.1.1	Overview	631
16.1.2	Design	631
16.1.3	C++ Classes for MPI	632
16.1.4	Class Member Functions for MPI	632
16.1.5	Semantics	633
16.1.6	C++ Datatypes	635
16.1.7	Communicators	638
16.1.8	Exceptions	640
16.1.9	Mixed-Language Operability	641
16.1.10	Profiling	641
16.2	Fortran Support	644

	16.2.1 Overview	644
ticket230-B.	16.2.2 Fortran Support Through the <code>mpi_f08</code> Module	646
ticket230-B.	16.2.3 [Extended] Fortran Support Through the <code>mpi</code> Module	648
ticket230-B.	The <code>mpi</code> Module	649
	No Type Mismatch Problems for Subroutines with Choice Arguments	651
ticket230-B.	16.2.4 [Basic] Fortran Support Through the <code>mpif.h</code> Include File	651
ticket230-B.	16.2.5 Interface Specifications, Linker Names and the Profiling Interface	653
ticket247-S.	16.2.6 MPI for Different Fortran Standard Versions	658
ticket247-S.	16.2.7 Requirements on Fortran Compilers	661
ticket230-B.	16.2.8 Additional Support for Fortran Register-Memory-Synchronization	663
ticket238-J.	16.2.9 Additional Support for Fortran Numeric Intrinsic Types	664
	Parameterized Datatypes with Specified Precision and Exponent Range	665
	Support for Size-specific MPI Datatypes	669
	Communication With Size-specific Types	671
	16.2.10 Problems With Fortran Bindings for MPI	672
	16.2.11 Problems Due to Strong Typing	674
	Problems Due to Strong Typing	674
ticket236-H.	16.2.12 Problems Due to Data Copying and Sequence Association with Subscript Triplets	675
	Problems Due to Data Copying and Sequence Association	675
ticket236-H.	16.2.13 Problems Due to Data Copying and Sequence Association with Vector Subscripts	678
	16.2.14 Special Constants	678
	Special Constants	679
	16.2.15 Fortran Derived Types	679
	Fortran 90 Derived Types	679
	16.2.16 Optimization Problems, an Overview	681
	A Problem with Register Optimization	681
ticket238-J.	16.2.17 Problems with Code Movement and Register Optimization	682
	Nonblocking operations	682
	One-sided communication	683
	MPI_BOTTOM and combining independent variables in datatypes	683
ticket238-J.	Solutions	684
ticket238-J.	The Fortran ASYNCHRONOUS attribute	686
ticket238-J.	Calling MPI_F_SYNC_REG	687
	A user defined routine instead of MPI_F_SYNC_REG	688
	Module variables and COMMON blocks	689
	The (poorly performing) Fortran VOLATILE attribute	689
ticket238-J.	The Fortran TARGET attribute	689
ticket238-J.	16.2.18 Temporary Data Movement and Temporary Memory Modification	690
ticket238-J.	16.2.19 Permanent Data Movement	692
	16.2.20 Comparison with C	692
	16.3 Language Interoperability	696
	16.3.1 Introduction	696
	16.3.2 Assumptions	696
	16.3.3 Initialization	696
	16.3.4 Transfer of Handles	697
	16.3.5 Status	700

16.3.6	MPI Opaque Objects	703	
	Datatypes	703	
	Callback Functions	705	
	Error Handlers	705	
	Reduce Operations	705	
	Addresses	705	
16.3.7	Attributes	706	
16.3.8	Extra State	710	
16.3.9	Constants	710	
16.3.10	Interlanguage Communication	711	
A	Language Bindings Summary	713	
A.1	Defined Values and Handles	713	
A.1.1	Defined Constants	713	
A.1.2	Types	729	
A.1.3	Prototype [d]Definitions	730	ticket0.
	C Bindings	730	
	Fortran 2008 Bindings with the mpi_f08 Module	731	
	Fortran Bindings with mpif.h or the mpi Module	734	
	C++ Bindings (deprecated)	736	
A.1.4	Deprecated [p]Prototype [d]Definitions	737	ticket0.
A.1.5	Info Keys	737	ticket0.
A.1.6	Info Values	738	
A.2	C Bindings	739	
A.2.1	Point-to-Point Communication C Bindings	739	
A.2.2	Datatypes C Bindings	741	
A.2.3	Collective Communication C Bindings	742	
A.2.4	Groups, Contexts, Communicators, and Caching C Bindings	745	
A.2.5	Process Topologies C Bindings	748	
A.2.6	MPI Environmental Management C Bindings	750	
A.2.7	The Info Object C Bindings	751	
A.2.8	Process Creation and Management C Bindings	751	
A.2.9	One-Sided Communications C Bindings	752	
A.2.10	External Interfaces C Bindings	754	
A.2.11	I/O C Bindings	754	
A.2.12	Language Bindings C Bindings	757	
A.2.13	Profiling Interface C Bindings	758	
A.2.14	Deprecated C Bindings	758	
A.3	Fortran 2008 Bindings with the mpi_f08 Module	760	
A.3.1	Point-to-Point Communication Fortran 2008 Bindings	760	
A.3.2	Datatypes Fortran 2008 Bindings	765	
A.3.3	Collective Communication Fortran 2008 Bindings	769	
A.3.4	Groups, Contexts, Communicators, and Caching Fortran 2008 Bindings	777	
A.3.5	Process Topologies Fortran 2008 Bindings	783	
A.3.6	MPI Environmental Management Fortran 2008 Bindings	788	
A.3.7	The Info Object Fortran 2008 Bindings	791	
A.3.8	Process Creation and Management Fortran 2008 Bindings	792	
A.3.9	One-Sided Communications Fortran 2008 Bindings	793	

A.3.10	External Interfaces Fortran 2008 Bindings	798
A.3.11	I/O Fortran 2008 Bindings	799
A.3.12	Language Bindings Fortran 2008 Bindings	806
A.3.13	Profiling Interface Fortran 2008 Bindings	807
A.3.14	Deprecated Fortran 2008 Bindings	807
A.4	Fortran Bindings with mpif.h or the mpi Module	808
A.4.1	Point-to-Point Communication Fortran Bindings	808
A.4.2	Datatypes Fortran Bindings	811
A.4.3	Collective Communication Fortran Bindings	813
A.4.4	Groups, Contexts, Communicators, and Caching Fortran Bindings	817
A.4.5	Process Topologies Fortran Bindings	821
A.4.6	MPI Environmental Management Fortran Bindings	823
A.4.7	The Info Object Fortran Bindings	825
A.4.8	Process Creation and Management Fortran Bindings	826
A.4.9	One-Sided Communications Fortran Bindings	827
A.4.10	External Interfaces Fortran Bindings	830
A.4.11	I/O Fortran Bindings	831
A.4.12	Language Bindings Fortran Bindings	835
A.4.13	Profiling Interface Fortran Bindings	835
A.4.14	Deprecated Fortran Bindings	835
A.5	C++ Bindings (deprecated)	838
A.5.1	Point-to-Point Communication C++ Bindings	838
A.5.2	Datatypes C++ Bindings	841
A.5.3	Collective Communication C++ Bindings	843
A.5.4	Groups, Contexts, Communicators, and Caching C++ Bindings	846
A.5.5	Process Topologies C++ Bindings	849
A.5.6	MPI Environmental Management C++ Bindings	850
A.5.7	The Info Object C++ Bindings	851
A.5.8	Process Creation and Management C++ Bindings	852
A.5.9	One-Sided Communications C++ Bindings	853
A.5.10	External Interfaces C++ Bindings	854
A.5.11	I/O C++ Bindings	854
A.5.12	Language Bindings C++ Bindings	858
A.5.13	Profiling Interface C++ Bindings	859
A.5.14	C++ Bindings on all MPI Classes	859
A.5.15	Construction / Destruction	859
A.5.16	Copy / Assignment	859
A.5.17	Comparison	859
A.5.18	Inter-language Operability	860
B	Change-Log	861
B.1	Changes from Version 2.2 to Version 3.0	861
B.2	TEST for Tickets 271, 168, 204, 280, 286, 287	868
B.3	Changes from Version 2.1 to Version 2.2	869
B.4	Changes from Version 2.0 to Version 2.1	872
	Bibliography	877

Examples Index	882
MPI Constant and Predefined Handle Index	885
MPI Declarations Index	893
MPI Callback Function Prototype Index	895
MPI Function Index	896

List of Figures

5.1	Collective communications, an overview	153
5.2	Intercommunicator allgather	156
5.3	Intercommunicator reduce-scatter	157
5.4	Gather example	164
5.5	Gatherv example with strides	165
5.6	Gatherv example, 2-dimensional	166
5.7	Gatherv example, 2-dimensional, subarrays with different sizes	167
5.8	Gatherv example, 2-dimensional, subarrays with different sizes and strides	169
5.9	Scatter example	174
5.10	Scatterv example with strides	174
5.11	Scatterv example with different strides and counts	176
5.12	Race conditions with point-to-point and collective communications	231
5.13	Overlapping Communicators Example	235
6.1	Intercommunicator create using MPI_COMM_CREATE	256
6.2	Intercommunicator construction with MPI_COMM_SPLIT	259
6.3	Three-group pipeline[ticket0.][.]	275
6.4	Three-group ring[ticket0.][.]	276
7.1	Set-up of process structure for two-dimensional parallel Poisson solver.	346
7.2	Set-up of process structure for two-dimensional parallel Poisson solver.	347
7.3	Communication routine with local data copying and sparse neighborhood all-to-all.	348
7.4	Communication routine with sparse neighborhood all-to-all-w and without local data copying.	349
11.1	Schematic description of [ticket270.][window]the public/private window operations in the MPI_WIN_SEPARATE memory model for two overlapping windows.	456
11.2	Active target communication	458
11.3	Active target communication, with weak synchronization	459
11.4	Passive target communication	460
11.5	Active target communication with several processes	464
11.6	Symmetric communication	484
11.7	Deadlock situation	484
11.8	No deadlock	484
13.1	Etypes and filetypes	514
13.2	Partitioning a file among parallel processes	514
13.3	Displacements	527

13.4 Example array file layout	582
13.5 Example local array filetype for process 1	582
16.1 Status conversion routines	702

1
2
3
4
5
6
7
8
9
10
11
12
13
14
15
16
17
18
19
20
21
22
23
24
25
26
27
28
29
30
31
32
33
34
35
36
37
38
39
40
41
42
43
44
45
46
47
48

List of Tables

2.1	Deprecated [ticket0.341.]and removed constructs	19
3.1	Predefined MPI datatypes corresponding to Fortran datatypes	29
3.2	Predefined MPI datatypes corresponding to C datatypes	30
3.3	Predefined MPI datatypes corresponding to both C and Fortran datatypes	31
4.1	combiner values returned from MPI_TYPE_GET_ENVELOPE	125
6.1	MPI_COMM_* Function Behavior (in Inter-Communication Mode)	271
8.1	Error classes (Part 1)	368
8.2	Error classes (Part 2)	369
11.1	C types of attribute value argument to MPI_Win_get_attr and MPI_Win_set_attr.	436
11.2	Error classes in one-sided communication routines	473
13.1	Data access routines	529
13.2	“external32” sizes of predefined datatypes	564
13.3	I/O Error Classes	580
14.1	MPI tool information interface verbosity levels.	593
14.2	Constants to identify associations of variables.	594
14.3	MPI datatypes that can be used by the MPI tool information interface.	596
14.4	Scopes for control variables.	600
14.5	Return codes used in functions of the MPI tool information interface.	620
16.1	C++ names for the MPI C and C++ predefined datatypes	636
16.2	C++ names for the MPI Fortran predefined datatypes	636
16.3	C++ names for other MPI datatypes	637
16.4	Occurrence of Fortran optimization problems	682

Acknowledgments

This document is the product of a number of distinct efforts in three distinct phases: one for each of MPI-1, MPI-2, and MPI-3. This section describes these in historical order, starting with MPI-1. Some efforts, particularly parts of MPI-2, had distinct groups of individuals associated with them, and these efforts are detailed separately.

This document represents the work of many people who have served on the MPI Forum. The meetings have been attended by dozens of people from many parts of the world. It is the hard and dedicated work of this group that has led to the MPI standard.

The technical development was carried out by subgroups, whose work was reviewed by the full committee. During the period of development of the Message-Passing Interface (MPI), many people helped with this effort.

Those who served as primary coordinators in MPI-1.0 and MPI-1.1 are:

- Jack Dongarra, David Walker, Conveners and Meeting Chairs
- Ewing Lusk, Bob Knighten, Minutes
- Marc Snir, William Gropp, Ewing Lusk, Point-to-Point Communication
- Al Geist, Marc Snir, Steve Otto, Collective Communication
- Steve Otto, Editor
- Rolf Hempel, Process Topologies
- Ewing Lusk, Language Binding
- William Gropp, Environmental Management
- James Cownie, Profiling
- Tony Skjellum, Lyndon Clarke, Marc Snir, Richard Littlefield, Mark Sears, Groups, Contexts, and Communicators
- Steven Huss-Lederman, Initial Implementation Subset

The following list includes some of the active participants in the MPI-1.0 and MPI-1.1 process not mentioned above.

1	Ed Anderson	Robert Babb	Joe Baron	Eric Barszcz
2	Scott Berryman	Rob Bjornson	Nathan Doss	Anne Elster
3	Jim Feeney	Vince Fernando	Sam Fineberg	Jon Flower
4	Daniel Frye	Ian Glendinning	Adam Greenberg	Robert Harrison
5	Leslie Hart	Tom Haupt	Don Heller	Tom Henderson
6	Alex Ho	C.T. Howard Ho	Gary Howell	John Kapenga
7	James Kohl	Susan Krauss	Bob Leary	Arthur Maccabe
8	Peter Madams	Alan Mainwaring	Oliver McBryan	Phil McKinley
9	Charles Mosher	Dan Nessett	Peter Pacheco	Howard Palmer
10	Paul Pierce	Sanjay Ranka	Peter Rigsbee	Arch Robison
11	Erich Schikuta	Ambuj Singh	Alan Sussman	Robert Tomlinson
12	Robert G. Voigt	Dennis Weeks	Stephen Wheat	Steve Zenith

13
14
15 The University of Tennessee and Oak Ridge National Laboratory made the draft avail-
16 able by anonymous FTP mail servers and were instrumental in distributing the document.

17 The work on the MPI-1 standard was supported in part by ARPA and NSF under grant
18 ASC-9310330, the National Science Foundation Science and Technology Center Cooperative
19 Agreement No. CCR-8809615, and by the Commission of the European Community through
20 Esprit project P6643 (PPPE).

21
22
23 **MPI-1.2 and MPI-2.0:**

24 Those who served as primary coordinators in MPI-1.2 and MPI-2.0 are:

- 25
- 26 ● Ewing Lusk, Convener and Meeting Chair
- 27
- 28 ● Steve Huss-Lederman, Editor
- 29
- 30 ● Ewing Lusk, Miscellany
- 31
- 32 ● Bill Saphir, Process Creation and Management
- 33
- 34 ● Marc Snir, One-Sided Communications
- 35
- 36 ● Bill Gropp and Anthony Skjellum, Extended Collective Operations
- 37
- 38 ● Steve Huss-Lederman, External Interfaces
- 39
- 40 ● Bill Nitzberg, I/O
- 41
- 42 ● Andrew Lumsdaine, Bill Saphir, and Jeff Squyres, Language Bindings
- 43
- 44 ● Anthony Skjellum and Arkady Kanevsky, Real-Time

45
46
47
48 The following list includes some of the active participants who attended MPI-2 Forum
meetings and are not mentioned above.

Greg Astfalk	Robert Babb	Ed Benson	Rajesh Bordawekar	1
Pete Bradley	Peter Brennan	Ron Brightwell	Maciej Brodowicz	2
Eric Brunner	Greg Burns	Margaret Cahir	Pang Chen	3
Ying Chen	Albert Cheng	Yong Cho	Joel Clark	4
Lyndon Clarke	Laurie Costello	Dennis Cottel	Jim Cownie	5
Zhenqian Cui	Suresh Damodaran-Kamal		Raja Daoud	6
Judith Devaney	David DiNucci	Doug Doefler	Jack Dongarra	7
Terry Dontje	Nathan Doss	Anne Elster	Mark Fallon	8
Karl Feind	Sam Fineberg	Craig Fischberg	Stephen Fleischman	9
Ian Foster	Hubertus Franke	Richard Frost	Al Geist	10
Robert George	David Greenberg	John Hagedorn	Kei Harada	11
Leslie Hart	Shane Hebert	Rolf Hempel	Tom Henderson	12
Alex Ho	Hans-Christian Hoppe	Joefon Jann	Terry Jones	13
Karl Kesselman	Koichi Konishi	Susan Kraus	Steve Kubica	14
Steve Landherr	Mario Lauria	Mark Law	Juan Leon	15
Lloyd Lewins	Ziyang Lu	Bob Madahar	Peter Madams	16
John May	Oliver McBryan	Brian McCandless	Tyce McLarty	17
Thom McMahon	Harish Nag	Nick Nevin	Jarek Nieplocha	18
Ron Oldfield	Peter Ossadnik	Steve Otto	Peter Pacheco	19
Yoonho Park	Perry Partow	Pratap Pattnaik	Elsie Pierce	20
Paul Pierce	Heidi Poxon	Jean-Pierre Prost	Boris Protopopov	21
James Pruyve	Rolf Rabenseifner	Joe Rieken	Peter Rigsbee	22
Tom Robey	Anna Rounbehler	Nobutoshi Sagawa	Arindam Saha	23
Eric Salo	Darren Sanders	Eric Sharakan	Andrew Sherman	24
Fred Shirley	Lance Shuler	A. Gordon Smith	Ian Stockdale	25
David Taylor	Stephen Taylor	Greg Tensa	Rajeev Thakur	26
Marydell Tholburn	Dick Treumann	Simon Tsang	Manuel Ujaldon	27
David Walker	Jerrell Watts	Klaus Wolf	Parkson Wong	28
Dave Wright				29

The MPI Forum also acknowledges and appreciates the valuable input from people via e-mail and in person.

The following institutions supported the MPI-2 effort through time and travel support for the people listed above.

Argonne National Laboratory	36
Bolt, Beranek, and Newman	37
California Institute of Technology	38
Center for Computing Sciences	39
Convex Computer Corporation	40
Cray Research	41
Digital Equipment Corporation	42
Dolphin Interconnect Solutions, Inc.	43
Edinburgh Parallel Computing Centre	44
General Electric Company	45
German National Research Center for Information Technology	46
Hewlett-Packard	47
Hitachi	48

1 Hughes Aircraft Company
2 Intel Corporation
3 International Business Machines
4 Khoral Research
5 Lawrence Livermore National Laboratory
6 Los Alamos National Laboratory
7 MPI Software Technology, Inc.
8 Mississippi State University
9 NEC Corporation
10 National Aeronautics and Space Administration
11 National Energy Research Scientific Computing Center
12 National Institute of Standards and Technology
13 National Oceanic and Atmospheric Administration
14 Oak Ridge National Laboratory
15 Ohio State University
16 PALLAS GmbH
17 Pacific Northwest National Laboratory
18 Pratt & Whitney
19 San Diego Supercomputer Center
20 Sanders, A Lockheed-Martin Company
21 Sandia National Laboratories
22 Schlumberger
23 Scientific Computing Associates, Inc.
24 Silicon Graphics Incorporated
25 Sky Computers
26 Sun Microsystems Computer Corporation
27 Syracuse University
28 The MITRE Corporation
29 Thinking Machines Corporation
30 United States Navy
31 University of Colorado
32 University of Denver
33 University of Houston
34 University of Illinois
35 University of Maryland
36 University of Notre Dame
37 University of San Francisco
38 University of Stuttgart Computing Center
39 University of Wisconsin

40
41 MPI-2 operated on a very tight budget (in reality, it had no budget when the first
42 meeting was announced). Many institutions helped the MPI-2 effort by supporting the
43 efforts and travel of the members of the MPI Forum. Direct support was given by NSF and
44 DARPA under NSF contract CDA-9115428 for travel by U.S. academic participants and
45 Esprit under project HPC Standards (21111) for European participants.
46

47
48

MPI-1.3 and MPI-2.1:

The editors and organizers of the combined documents have been:

- Richard Graham, Convener and Meeting Chair
- Jack Dongarra, Steering Committee
- Al Geist, Steering Committee
- Bill Gropp, Steering Committee
- Rainer Keller, Merge of MPI-1.3
- Andrew Lumsdaine, Steering Committee
- Ewing Lusk, Steering Committee, MPI-1.1-Errata (Oct. 12, 1998) MPI-2.1-Errata Ballots 1, 2 (May 15, 2002)
- Rolf Rabenseifner, Steering Committee, Merge of MPI-2.1 and MPI-2.1-Errata Ballots 3, 4 (2008)

All chapters have been revisited to achieve a consistent MPI-2.1 text. Those who served as authors for the necessary modifications are:

- Bill Gropp, Frontmatter, Introduction, and Bibliography
- Richard Graham, Point-to-Point Communication
- Adam Moody, Collective Communication
- Richard Treumann, Groups, Contexts, and Communicators
- Jesper Larsson Träff, Process Topologies, Info-Object, and One-Sided Communications
- George Bosilca, Environmental Management
- David Solt, Process Creation and Management
- Bronis R. de Supinski, External Interfaces, and Profiling
- Rajeev Thakur, I/O
- Jeffrey M. Squyres, Language Bindings and MPI 2.1 Secretary
- Rolf Rabenseifner, Deprecated Functions and Annex Change-Log
- Alexander Supalov and Denis Nagorny, Annex Language Bindings

The following list includes some of the active participants who attended MPI-2 Forum meetings and in the e-mail discussions of the errata items and are not mentioned above.

1	Pavan Balaji	Purushotham V. Bangalore	Brian Barrett
2	Richard Barrett	Christian Bell	Robert Blackmore
3	Gil Bloch	Ron Brightwell	Jeffrey Brown
4	Darius Buntinas	Jonathan Carter	Nathan DeBardeleben
5	Terry Dontje	Gabor Dozsa	Edric Ellis
6	Karl Feind	Edgar Gabriel	Patrick Geoffray
7	David Gingold	Dave Goodell	Erez Haba
8	Robert Harrison	Thomas Herault	Steve Hodson
9	Torsten Hoefler	Joshua Hursey	Yann Kalemkarian
10	Matthew Koop	Quincey Koziol	Sameer Kumar
11	Miron Livny	Kannan Narasimhan	Mark Pagel
12	Avneesh Pant	Steve Poole	Howard Pritchard
13	Craig Rasmussen	Hubert Ritzdorf	Rob Ross
14	Tony Skjellum	Brian Smith	Vinod Tipparaju
15	Jesper Larsson Träff	Keith Underwood	

16 The MPI Forum also acknowledges and appreciates the valuable input from people via
17 e-mail and in person.

19 The following institutions supported the MPI-2 effort through time and travel support
20 for the people listed above.

- 22 Argonne National Laboratory
- 23 Bull
- 24 Cisco Systems, Inc.
- 25 Cray Inc.
- 26 The HDF Group
- 27 Hewlett-Packard
- 28 IBM T.J. Watson Research
- 29 Indiana University
- 30 Institut National de Recherche en Informatique et Automatique (INRIA)
- 31 Intel Corporation
- 32 Lawrence Berkeley National Laboratory
- 33 Lawrence Livermore National Laboratory
- 34 Los Alamos National Laboratory
- 35 Mathworks
- 36 Mellanox Technologies
- 37 Microsoft
- 38 Myricom
- 39 NEC Laboratories Europe, NEC Europe Ltd.
- 40 Oak Ridge National Laboratory
- 41 Ohio State University
- 42 Pacific Northwest National Laboratory
- 43 QLogic Corporation
- 44 Sandia National Laboratories
- 45 SiCortex
- 46 Silicon Graphics Incorporated
- 47 Sun Microsystems, Inc.
- 48 University of Alabama at Birmingham

University of Houston
University of Illinois at Urbana-Champaign
University of Stuttgart, High Performance Computing Center Stuttgart (HLRS)
University of Tennessee, Knoxville
University of Wisconsin

Funding for the MPI Forum meetings was partially supported by award #CCF-0816909 from the National Science Foundation. []In addition, the HDF Group provided travel support for one U.S. academic.

MPI-2.2:

All chapters have been revisited to achieve a consistent MPI-2.2 text. Those who served as authors for the necessary modifications are:

- William Gropp, Frontmatter, Introduction, and Bibliography; MPI 2.2 chair.
- Richard Graham, Point-to-Point Communication and Datatypes
- Adam Moody, Collective Communication
- Torsten Hoefler, Collective Communication and Process Topologies
- Richard Treumann, Groups, Contexts, and Communicators
- Jesper Larsson Träff, Process Topologies, Info-Object and One-Sided Communications
- George Bosilca, Datatypes and Environmental Management
- David Solt, Process Creation and Management
- Bronis R. de Supinski, External Interfaces, and Profiling
- Rajeev Thakur, I/O
- Jeffrey M. Squyres, Language Bindings and MPI 2.2 Secretary
- Rolf Rabenseifner, Deprecated Functions, Annex Change-Log, and Annex Language Bindings
- Alexander Supalov, Annex Language Bindings

The following list includes some of the active participants who attended MPI-2 Forum meetings and in the e-mail discussions of the errata items and are not mentioned above.

1	Pavan Balaji	Purushotham V. Bangalore	Brian Barrett
2	Richard Barrett	Christian Bell	Robert Blackmore
3	Gil Bloch	Ron Brightwell	Greg Bronevetsky
4	Jeff Brown	Darius Buntinas	Jonathan Carter
5	Nathan DeBardeleben	Terry Dontje	Gabor Dozsa
6	Edric Ellis	Karl Feind	Edgar Gabriel
7	Patrick Geoffray	Johann George	David Gingold
8	David Goodell	Erez Haba	Robert Harrison
9	Thomas Herault	Marc-André Hermanns	Steve Hodson
10	Joshua Hursey	Yutaka Ishikawa	Bin Jia
11	Hideyuki Jitsumoto	Terry Jones	Yann Kalemkarian
12	Ranier Keller	Matthew Koop	Quincey Koziol
13	Manojkumar Krishnan	Sameer Kumar	Miron Livny
14	Andrew Lumsdaine	Miao Luo	Ewing Lusk
15	Timothy I. Mattox	Kannan Narasimhan	Mark Pagel
16	Avneesh Pant	Steve Poole	Howard Pritchard
17	Craig Rasmussen	Hubert Ritzdorf	Rob Ross
18	Martin Schulz	Pavel Shamis	Galen Shipman
19	Christian Siebert	Anthony Skjellum	Brian Smith
20	Naoki Sueyasu	Vinod Tipparaju	Keith Underwood
21	Rolf Vandevaart	Abhinav Vishnu	Weikuan Yu

22 The MPI Forum also acknowledges and appreciates the valuable input from people via
23 e-mail and in person.
24

25 The following institutions supported the MPI-2.2 effort through time and travel support
26 for the people listed above.

- 27 Argonne National Laboratory
- 28 Auburn University
- 29 Bull
- 30 Cisco Systems, Inc.
- 31 Cray Inc.
- 32 Forschungszentrum Jülich
- 33 Fujitsu
- 34 The HDF Group
- 35 Hewlett-Packard
- 36 International Business Machines
- 37 Indiana University
- 38 Institut National de Recherche en Informatique et Automatique (INRIA)
- 39 Institute for Advanced Science & Engineering Corporation
- 40 Intel Corporation
- 41 Lawrence Berkeley National Laboratory
- 42 Lawrence Livermore National Laboratory
- 43 Los Alamos National Laboratory
- 44 Mathworks
- 45 Mellanox Technologies
- 46 Microsoft
- 47 Myricom
- 48

NEC Corporation
Oak Ridge National Laboratory
Ohio State University
Pacific Northwest National Laboratory
QLogic Corporation
RunTime Computing Solutions, LLC
Sandia National Laboratories
SiCortex, Inc.
Silicon Graphics Inc.
Sun Microsystems, Inc.
Tokyo Institute of Technology
University of Alabama at Birmingham
University of Houston
University of Illinois at Urbana-Champaign
University of Stuttgart, High Performance Computing Center Stuttgart (HLRS)
University of Tennessee, Knoxville
University of Tokyo
University of Wisconsin

Funding for the MPI Forum meetings was partially supported by award #CCF-0816909 from the National Science Foundation. []In addition, the HDF Group provided travel support for one U.S. academic.

MPI-3:

MPI-3 is a significant effort to extend and modernize the MPI Standard.

The editors and organizers of the MPI-3 have been: *Taken from MPI-2.2 with minor corrections. Need to separate the working groups list (which is currently reviewers) from the primary authors . Also, did I miss active steering committee members?*

- William Gropp, Steering committee, Frontmatter, Introduction, Groups, Contexts, and Communicators, One-Sided Communications, and Bibliography
- Richard Graham, Steering committee, Point-to-Point Communication; Meeting Convener, and MPI-3 chair
- Adam Moody, Collective Communication
- Torsten Hoefler, Collective Communication and Process Topologies
- George Bosilca, Datatypes and Environmental Management
- David Solt, Process Creation and Management
- Bronis R. de Supinski, External Interfaces, and Profiling
- Rajeev Thakur, I/O and One-Sided Communications
- Darius Buntinas, Info Object
- Jeffrey M. Squyres, Language Bindings and MPI 3.0 Secretary

ticket229.2.

ticket229.2.

1
2
3
4
5
6
7
8
9
10
11
12
13
14
15
16
17
18
19
20
21
22
23
24
25
26
27
28
29
30
31
32
33
34
35
36
37
38
39
40
41
42
43
44
45
46
47
48

- Rolf Rabenseifner, Steering committee, Terms and Definitions, Fortran Bindings, Deprecated Functions, Annex Change-Log, and Annex Language Bindings
- Craig Rasmussen, Fortran Bindings

The following list includes some of the active participants who attended MPI-3 Forum meetings and in the e-mail discussions of the errata items and are not mentioned above.

Sadaf Alam	Pavan Balaji	Purushotham V. Bangalore
Brian Barrett	Richard Barrett	Robert Blackmore
Ron Brightwell	Greg Bronevetsky	Darius Buntinas
James Dinan	Terry Dontje	Gabor Dozsa
Edgar Gabriel	David Goodell	Manjunath Gorentla Vankata
Erez Haba	Jeff Hammond	Thomas Herault
Marc-André Hermanns	Jennifer Herrett-Skjellum	Joshua Hursey
Yutaka Ishikawa	Bin Jia	Hideyuki Jitsumoto
Yann Kalemkarian	Chulho Kim	Christof Klausecker
Alice Koniges	Quincey Koziol	Dieter Kranzlmüller
Manojkumar Krishnan	Sameer Kumar	Andrew Lumsdaine
Miao Luo	Ewing Lusk	Kathryn Mohror
Steve Oyanagi	Mark Pagel	Steve Poole
Howard Pritchard	[ticket229.2.] Hubert Ritzdorf	
Timo Schneider	Martin Schulz	Christian Siebert
Anthony Skjellum	Brian Smith	Marc Snir
Shinji Sumimoto	Alexander Supalov	Sayantan Sur
Fabian Tillier	Vinod Tipparaju	Keith Underwood
Rolf Vandevaart	Abhinav Vishnu	

The MPI Forum also acknowledges and appreciates the valuable input from people via e-mail and in person.

The following institutions supported the MPI-3 effort through time and travel support for the people listed above.

- Argonne National Laboratory
- Bull
- Cisco Systems, Inc.
- Cray Inc.
- CSCS
- Forschungszentrum Jülich
- Fujitsu
- German Research School for Simulation Sciences
- The HDF Group
- Hewlett-Packard
- International Business Machines
- IBM India Private Ltd
- Indiana University
- Institut National de Recherche en Informatique et Automatique (INRIA)
- Institute for Advanced Science & Engineering Corporation
- Intel Corporation

Lawrence Berkeley National Laboratory	1
Lawrence Livermore National Laboratory	2
Los Alamos National Laboratory	3
Ludwig-Maximilians Universität München	4
Microsoft	5
NEC Corporation	6
Oak Ridge National Laboratory	7
The Ohio State University	8
Oracle America	9
Pacific Northwest National Laboratory	10
QLogic Corporation	11
RunTime Computing Solutions, LLC	12
Sandia National Laboratory	13
Technical University of Chemnitz	14
Tokyo Institute of Technology	15
University of Alabama at Birmingham	16
University of Chicago	17
University of Houston	18
University of Illinois at Urbana-Champaign	19
University of Stuttgart, High Performance Computing Center Stuttgart (HLRS)	20
University of Tennessee, Knoxville	21
University of Tokyo	22

Funding for the MPI Forum meetings was partially supported by award #CCF-0816909 from the National Science Foundation. In addition, the HDF Group provided travel support for one U.S. academic.

1
2
3
4
5
6
7
8
9
10
11
12
13
14
15
16
17
18
19
20
21
22
23
24
25
26
27
28
29
30
31
32
33
34
35
36
37
38
39
40
41
42
43
44
45
46
47
48

Chapter 1

Introduction to MPI

1.1 Overview and Goals

MPI (Message-Passing Interface) is a *message-passing library interface specification*. All parts of this definition are significant. MPI addresses primarily the message-passing parallel programming model, in which data is moved from the address space of one process to that of another process through cooperative operations on each process. [Extensions to the “classical” message-passing model are provided in collective operations, remote-memory access operations, dynamic process creation, and parallel I/O.] MPI is a *specification*, not an implementation; there are multiple implementations of MPI. This specification is for a *library interface*; MPI is not a language, and all MPI operations are expressed as functions, subroutines, or methods, according to the appropriate language bindings, which for C, C++, [Fortran-77, and Fortran-95]and Fortran, are part of the MPI standard. The standard has been defined through an open process by a community of parallel computing vendors, computer scientists, and application developers. The next few sections provide an overview of the history of MPI’s development.

ticket0.
ticket0.
ticket230-B.

The main advantages of establishing a message-passing standard are portability and ease of use. In a distributed memory communication environment in which the higher level routines and/or abstractions are built upon lower level message-passing routines the benefits of standardization are particularly apparent. Furthermore, the definition of a message-passing standard, such as that proposed here, provides vendors with a clearly defined base set of routines that they can implement efficiently, or in some cases [provide hardware support for]for which they can provide hardware support, thereby enhancing scalability.

ticket0.

The goal of the Message-Passing Interface simply stated is to develop a widely used standard for writing message-passing programs. As such the interface should establish a practical, portable, efficient, and flexible standard for message passing.

A complete list of goals follows.

- Design an application programming interface (not necessarily for compilers or a system implementation library).
- Allow efficient communication: Avoid memory-to-memory copying, allow overlap of computation and communication, and offload to communication co-processor, where available.
- Allow for implementations that can be used in a heterogeneous environment.

- Allow convenient C, C++, [Fortran-77, and Fortran-95]and Fortran bindings for the interface.
- Assume a reliable communication interface: the user need not cope with communication failures. Such failures are dealt with by the underlying communication subsystem.
- Define an interface that can be implemented on many vendor's platforms, with no significant changes in the underlying communication and system software.
- Semantics of the interface should be language independent.
- The interface should be designed to allow for thread safety.

1.2 Background of MPI-1.0

MPI sought to make use of the most attractive features of a number of existing message-passing systems, rather than selecting one of them and adopting it as the standard. Thus, MPI was strongly influenced by work at the IBM T. J. Watson Research Center [1, 2], Intel's NX/2 [50], Express [13], nCUBE's Vertex [46], p4 [8, 9], and PARMACS [5, 10]. Other important contributions have come from Zipcode [53, 54], Chimp [17, 18], PVM [4, 15], Chameleon [27], and PICL [25].

The MPI standardization effort involved about 60 people from 40 organizations mainly from the United States and Europe. Most of the major vendors of concurrent computers were involved in MPI, along with researchers from universities, government laboratories, and industry. The standardization process began with the Workshop on Standards for Message-Passing in a Distributed Memory Environment, sponsored by the Center for Research on Parallel Computing, held April 29-30, 1992, in Williamsburg, Virginia [61]. At this workshop the basic features essential to a standard message-passing interface were discussed, and a working group established to continue the standardization process.

A preliminary draft proposal, known as MPI1, was put forward by Dongarra, Hempel, Hey, and Walker in November 1992, and a revised version was completed in February 1993 [16]. MPI1 embodied the main features that were identified at the Williamsburg workshop as being necessary in a message passing standard. Since MPI1 was primarily intended to promote discussion and "get the ball rolling," it focused mainly on point-to-point communications. MPI1 brought to the forefront a number of important standardization issues, but did not include any collective communication routines and was not thread-safe.

In November 1992, a meeting of the MPI working group was held in Minneapolis, at which it was decided to place the standardization process on a more formal footing, and to generally adopt the procedures and organization of the High Performance Fortran Forum. Subcommittees were formed for the major component areas of the standard, and an email discussion service established for each. In addition, the goal of producing a draft MPI standard by the Fall of 1993 was set. To achieve this goal the MPI working group met every 6 weeks for two days throughout the first 9 months of 1993, and presented the draft MPI standard at the Supercomputing 93 conference in November 1993. These meetings and the email discussion together constituted the MPI Forum, membership of which has been open to all members of the high performance computing community.

1.3 Background of MPI-1.1, MPI-1.2, and MPI-2.0

Beginning in March 1995, the MPI Forum began meeting to consider corrections and extensions to the original MPI Standard document [22]. The first product of these deliberations was Version 1.1 of the MPI specification, released in June of 1995 [23] (see <http://www.mpi-forum.org> for official MPI document releases). At that time, effort focused in five areas.

1. Further corrections and clarifications for the MPI-1.1 document.
2. Additions to MPI-1.1 that do not significantly change its types of functionality (new datatype constructors, language interoperability, etc.).
3. Completely new types of functionality (dynamic processes, one-sided communication, parallel I/O, etc.) that are what everyone thinks of as “MPI-2 functionality.”
4. Bindings for Fortran 90 and C++. MPI-2 specifies C++ bindings for both MPI-1 and MPI-2 functions, and extensions to the Fortran 77 binding of MPI-1 and MPI-2 to handle Fortran 90 issues.
5. Discussions of areas in which the MPI process and framework seem likely to be useful, but where more discussion and experience are needed before standardization (e.g. zero-copy semantics on shared-memory machines, real-time specifications).

Corrections and clarifications (items of type 1 in the above list) were collected in Chapter 3 of the MPI-2 document: “Version 1.2 of MPI.” That chapter also contains the function for identifying the version number. Additions to MPI-1.1 (items of types 2, 3, and 4 in the above list) are in the remaining chapters of the MPI-2 document, and constitute the specification for MPI-2. Items of type 5 in the above list have been moved to a separate document, the “MPI Journal of Development” (JOD), and are not part of the MPI-2 Standard.

This structure makes it easy for users and implementors to understand what level of MPI compliance a given implementation has:

- MPI-1 compliance will mean compliance with MPI-1.3. This is a useful level of compliance. It means that the implementation conforms to the clarifications of MPI-1.1 function behavior given in Chapter 3 of the MPI-2 document. Some implementations may require changes to be MPI-1 compliant.
- MPI-2 compliance will mean compliance with all of MPI-2.1.
- The MPI Journal of Development is not part of the MPI Standard.

It is to be emphasized that forward compatibility is preserved. That is, a valid MPI-1.1 program is both a valid MPI-1.3 program and a valid MPI-2.1 program, and a valid MPI-1.3 program is a valid MPI-2.1 program.

1.4 Background of MPI-1.3 and MPI-2.1

After the release of MPI-2.0, the MPI Forum kept working on errata and clarifications for both standard documents (MPI-1.1 and MPI-2.0). The short document “Errata for MPI-1.1” was released October 12, 1998. On July 5, 2001, a first ballot of errata and clarifications for

1 MPI-2.0 was released, and a second ballot was voted on May 22, 2002. Both votes were done
 2 electronically. Both ballots were combined into one document: “Errata for MPI-2”, May
 3 15, 2002. This errata process was then interrupted, but the Forum and its e-mail reflectors
 4 kept working on new requests for clarification.

5 Restarting regular work of the MPI Forum was initiated in three meetings, at EuroPVM/MPI’06 in Bonn, at EuroPVM/MPI’07 in Paris, and at SC’07 in Reno. In De-
 6 cember 2007, a steering committee started the organization of new MPI Forum meetings at
 7 regular 8-weeks intervals. At the January 14-16, 2008 meeting in Chicago, the MPI Forum
 8 decided to combine the existing and future MPI documents to one [single] document for each
 9 version of the MPI standard. For technical and historical reasons, this series was started
 10 with MPI-1.3. Additional Ballots 3 and 4 solved old questions from the errata list started
 11 in 1995 up to new questions from the last years. After all documents (MPI-1.1, MPI-2,
 12 Errata for MPI-1.1 (Oct. 12, 1998), and MPI-2.1 Ballots 1-4) were combined into one draft
 13 document, for each chapter, a chapter author and review team were defined. They cleaned
 14 up the document to achieve a consistent MPI-2.1 document. The final MPI-2.1 standard
 15 document was finished in June 2008, and finally released with a second vote in September
 16 2008 in the meeting at Dublin, just before EuroPVM/MPI’08. The major work of the
 17 current MPI Forum is the preparation of MPI-3.
 18
 19

20 1.5 Background of MPI-2.2

21 MPI-2.2 is a minor update to the MPI-2.1 standard. This version addresses additional errors
 22 and ambiguities that were not corrected in the MPI-2.1 standard as well as a small number
 23 of extensions to MPI-2.1 that met the following criteria:
 24
 25

- 26 • Any correct MPI-2.1 program is a correct MPI-2.2 program.
- 27 • Any extension must have significant benefit for users.
- 28 • Any extension must not require significant implementation effort. To that end, all
 29 such changes are accompanied by an open source implementation.

30 The discussions of MPI-2.2 proceeded concurrently with the MPI-3 discussions; in some
 31 cases, extensions were proposed for MPI-2.2 but were later moved to MPI-3.
 32
 33

34 1.6 Background of MPI-3.0

35 MPI-3.0 is a major update to the MPI standard. Areas of particular interest are the extension
 36 of collective operations to include nonblocking, with other areas under consideration. This
 37 *draft* contains the MPI Forum’s current draft of nonblocking collective routines.
 38
 39

40 A new Fortran `mpi_f08` module is introduced to provide extended compile-time argu-
 41 ment checking and buffer handling in nonblocking routines. This new Fortran support
 42 method provides protection against the optimization problems [with] with asynchronous
 43 accesses to the buffers of nonblocking calls. The existing `mpi` module is enhanced to pro-
 44 vide basic compile-time argument checking for MPI calls. The use of `mpif.h` is strongly
 45 discouraged.
 46
 47
 48

1.7 Who Should Use This Standard?

This standard is intended for use by all those who want to write portable message-passing programs in Fortran, C and C++. This includes individual application programmers, developers of software designed to run on parallel machines, and creators of environments and tools. In order to be attractive to this wide audience, the standard must provide a simple, easy-to-use interface for the basic user while not semantically precluding the high-performance message-passing operations available on advanced machines.

1.8 What Platforms Are Targets For Implementation?

The attractiveness of the message-passing paradigm at least partially stems from its wide portability. Programs expressed this way may run on distributed-memory multiprocessors, networks of workstations, and combinations of all of these. In addition, shared-memory implementations, including those for multi-core processors and hybrid architectures, are possible. The paradigm will not be made obsolete by architectures combining the shared- and distributed-memory views, or by increases in network speeds. It thus should be both possible and useful to implement this standard on a great variety of machines, including those “machines” consisting of collections of other machines, parallel or not, connected by a communication network.

The interface is suitable for use by fully general MIMD programs, as well as those written in the more restricted style of SPMD. MPI provides many features intended to improve performance on scalable parallel computers with specialized interprocessor communication hardware. Thus, we expect that native, high-performance implementations of MPI will be provided on such machines. At the same time, implementations of MPI on top of standard Unix interprocessor communication protocols will provide portability to workstation clusters and heterogenous networks of workstations.

1.9 What Is Included In The Standard?

The standard includes:

- Point-to-point communication,
- Datatypes,
- Collective operations,
- Process groups,
- Communication contexts,
- Process topologies,
- Environmental [M]management and inquiry,
- The [i]Info object,
- Process creation and management,
- One-sided communication,

ticket0.

- 1 • External interfaces,
- 2
- ticket0. 3 • Parallel file I/O,
- 4
- ticket0. 5 • Language [B]bindings for Fortran, C and C++,
- ticket0. 6 • Profiling interface.
- 7

8 1.10 What Is Not Included In The Standard?

9

10 The standard does not specify:

- 11
- 12 • Operations that require more operating system support than is currently standard;
- 13 for example, interrupt-driven receives, remote execution, or active messages,
- 14
- 15 • Program construction tools,
- 16
- 17 • Debugging facilities.
- 18

19 There are many features that have been considered and not included in this standard.
 20 This happened for a number of reasons, one of which is the time constraint that was self-
 21 imposed in finishing the standard. Features that are not included can always be offered as
 22 extensions by specific implementations. Perhaps future versions of MPI will address some
 23 of these issues.

24 1.11 Organization of this Document

25

26

27 The following is a list of the remaining chapters in this document, along with a brief
 28 description of each.

- 29
- 30 • Chapter 2, MPI Terms and Conventions, explains notational terms and conventions
 31 used throughout the MPI document.
- 32
- 33 • Chapter 3, Point to Point Communication, defines the basic, pairwise communication
 34 subset of MPI. *Send* and *receive* are found here, along with many associated functions
 35 designed to make basic communication powerful and efficient.
- 36
- 37 • Chapter 4, Datatypes, defines a method to describe any data layout, e.g., an array of
 38 structures in the memory, which can be used as message send or receive buffer.
- 39
- 40 • Chapter 5, Collective Communications, defines process-group collective communication
 41 operations. Well known examples of this are barrier and broadcast over a group of
 42 processes (not necessarily all the processes). With MPI-2, the semantics of collective
 43 communication was extended to include intercommunicators. It also adds two new
 44 collective operations. **MPI-3 adds nonblocking collective operations.**
- 45
- 46 • Chapter 6, Groups, Contexts, Communicators, and Caching, shows how groups of pro-
 47 cesses are formed and manipulated, how unique communication contexts are obtained,
 48 and how the two are bound together into a *communicator*.

- Chapter 7, Process Topologies, explains a set of utility functions meant to assist in the mapping of process groups (a linearly ordered set) to richer topological structures such as multi-dimensional grids. 1
2
3
- Chapter 8, MPI Environmental Management, explains how the programmer can manage and make inquiries of the current MPI environment. These functions are needed for the writing of correct, robust programs, and are especially important for the construction of highly-portable message-passing programs. 4
5
6
7
8
- Chapter 9, The Info Object, defines an opaque object, that is used as input `[of]in` several MPI routines. 9
10 ticket0.
- Chapter 10, Process Creation and Management, defines routines that allow for creation of processes. 11
12
13
- Chapter 11, One-Sided Communications, defines communication routines that can be completed by a single process. These include shared-memory operations (`put/get`) and remote accumulate operations. 14
15
16
17
- Chapter 12, External Interfaces, defines routines designed to allow developers to layer on top of MPI. This includes generalized requests, routines that decode MPI opaque objects, and threads. 18
19
20
21
- Chapter 13, I/O, defines MPI support for parallel I/O. 22
23
- Chapter 14.2, Profiling Interface, explains a simple name-shifting convention that any MPI implementation must support. One motivation for this is the ability to put performance profiling calls into MPI without the need for access to the MPI source code. The name shift is merely an interface, it says nothing about how the actual profiling should be done and in fact, the name shift can be useful for other purposes. 24
25
26
27
28
- Chapter 15, Deprecated Functions, describes routines that are kept for reference. However usage of these functions is discouraged, as they may be deleted in future versions of the standard. 29
30
31
32
- Chapter 16, Language Bindings, describes the C++ binding, discusses Fortran issues, and describes language interoperability aspects between C, C++, and Fortran. 33
34
35

The Appendices are: 36
37

- Annex A, Language Bindings Summary, gives specific syntax in C, C++, and Fortran, for all MPI functions, constants, and types. 38
39
40
- Annex B, Change-Log, summarizes major changes since the previous version of the standard. 41
42
- Several Index pages `[are showing]show` the locations of examples, constants and pre-defined handles, callback routine`[s']` prototypes, and all MPI functions. 43 ticket0.
44 ticket0.
45

MPI provides various interfaces to facilitate interoperability of distinct MPI implementations. Among these are the canonical data representation for MPI I/O and for 46
47
48

1 MPI_PACK_EXTERNAL and MPI_UNPACK_EXTERNAL. The definition of an actual bind-
2 ing of these interfaces that will enable interoperability is outside the scope of this document.

3 A separate document consists of ideas that were discussed in the MPI Forum and
4 deemed to have value, but are not included in the MPI Standard. They are part of the
5 “Journal of Development” (JOD), lest good ideas be lost and in order to provide a starting
6 point for further work. The chapters in the JOD are

- 7
- 8 • Chapter 2, *Spawning Independent Processes*, includes some elements of dynamic pro-
9 cess management, in particular management of processes with which the spawning
10 processes do not intend to communicate, that the Forum discussed at length but
11 ultimately decided not to include in the MPI Standard.
- 12
- 13 • Chapter 3, *Threads and MPI*, describes some of the expected interaction between an
14 MPI implementation and a thread library in a multi-threaded environment.
- 15
- 16 • Chapter 4, *Communicator ID*, describes an approach to providing identifiers for com-
17 municators.
- 18
- 19 • Chapter 5, *Miscellany*, discusses Miscellaneous topics in the MPI JOD, in particu-
20 lar single-copy routines for use in shared-memory environments and new datatype
21 constructors.
- 22
- 23 • Chapter 6, *Toward a Full Fortran 90 Interface*, describes an approach to providing a
24 more elaborate Fortran 90 interface.
- 25
- 26 • Chapter 7, *Split Collective Communication*, describes a specification for certain non-
27 blocking collective operations.
- 28
- 29
- 30
- 31
- 32
- 33
- 34
- 35
- 36
- 37
- 38
- 39
- 40
- 41
- 42
- 43
- 44
- 45
- 46
- 47
- 48
- Chapter 8, *Real-Time MPI*, discusses MPI support for real time processing.

1
2
3
4
5
6
7
8
9
10
11
12
13
14
15
16
17
18
19
20
21
22
23
24
25
26
27
28
29
30
31
32
33
34
35
36
37
38
39
40
41
42
43
44
45
46
47
48

Chapter 2

MPI Terms and Conventions

This chapter explains notational terms and conventions used throughout the MPI document, some of the choices that have been made, and the rationale behind those choices. It is similar to the MPI-1 Terms and Conventions chapter but differs in some major and minor ways. Some of the major areas of difference are the naming conventions, some semantic definitions, file objects, Fortran 90 *vs* Fortran 77, C++, processes, and interaction with signals.

2.1 Document Notation

Rationale. Throughout this document, the rationale for the design choices made in the interface specification is set off in this format. Some readers may wish to skip these sections, while readers interested in interface design may want to read them carefully. (*End of rationale.*)

Advice to users. Throughout this document, material aimed at users and that illustrates usage is set off in this format. Some readers may wish to skip these sections, while readers interested in programming in MPI may want to read them carefully. (*End of advice to users.*)

Advice to implementors. Throughout this document, material that is primarily commentary to implementors is set off in this format. Some readers may wish to skip these sections, while readers interested in MPI implementations may want to read them carefully. (*End of advice to implementors.*)

2.2 Naming Conventions

In many cases MPI names for C functions are of the form `MPI_Class_action_subset`. This convention originated with MPI-1. Since MPI-2 an attempt has been made to standardize the names of MPI functions according to the following rules. The C++ bindings in particular follow these rules (see Section 2.6.4 on page 20).

1. In C, all routines associated with a particular type of MPI object should be of the form `MPI_Class_action_subset` or, if no subset exists, of the form `MPI_Class_action`. In Fortran, all routines associated with a particular type of MPI object should be of the form `MPI_CLASS_ACTION_SUBSET` or, if no subset exists, of the form

1 MPI_CLASS_ACTION. For C and Fortran we use the C++ terminology to define the
 2 Class. In C++, the routine is a method on **Class** and is named
 3 MPI::Class::Action_subset. If the routine is associated with a certain class, but does
 4 not make sense as an object method, it is a static member function of the class.

- 5
- 6 2. If the routine is not associated with a class, the name should be of the form
 7 MPI_Action_subset in C and MPI_ACTION_SUBSET in Fortran, and in C++ should
 8 be scoped in the MPI namespace, MPI::Action_subset.
- 9
- 10 3. The names of certain actions have been standardized. In particular, **Create** creates
 11 a new object, **Get** retrieves information about an object, **Set** sets this information,
 12 **Delete** deletes information, **Is** asks whether or not an object has a certain property.

13 C and Fortran names for some MPI functions (that were defined during the MPI-1
 14 process) violate these rules in several cases. The most common exceptions are the omission
 15 of the **Class** name from the routine and the omission of the **Action** where one can be
 16 inferred.

17 MPI identifiers are limited to 30 characters (31 with the profiling interface). This is
 18 done to avoid exceeding the limit on some compilation systems.

21 2.3 Procedure Specification

22 MPI procedures are specified using a language-independent notation. The arguments of
 23 procedure calls are marked as IN, OUT or INOUT. The meanings of these are:
 24

- 25 ticket140.
- 26 • IN: the call may use the input value but does not update the argument **from the**
 27 **perspective of the caller at any time during the call's execution,**
 - 28 • OUT: the call may update the argument but does not use its input value,
 - 29 • INOUT: the call may both use and update the argument.

30

31 There is one special case — if an argument is a handle to an opaque object (these
 32 terms are defined in Section 2.5.1), and the object is updated by the procedure call, then
 33 the argument is marked INOUT or OUT. It is marked this way even though the handle itself
 34 is not modified — we use the INOUT or OUT attribute to denote that what the handle
 35 *references* is updated. Thus, in C++, IN arguments are usually either references or pointers
 36 to **const** objects.

37

38 *Rationale.* The definition of MPI tries to avoid, to the largest possible extent, the use
 39 of INOUT arguments, because such use is error-prone, especially for scalar arguments.
 40 (*End of rationale.*)

41

42 MPI's use of IN, OUT and INOUT is intended to indicate to the user how an argument
 43 is to be used, but does not provide a rigorous classification that can be translated directly
 44 into all language bindings (e.g., **INTENT** in Fortran 90 bindings or **const** in C bindings).
 45 For instance, the “constant” MPI_BOTTOM can usually be passed to OUT buffer arguments.
 46 Similarly, MPI_STATUS_IGNORE can be passed as the OUT status argument.

47 A common occurrence for MPI functions is an argument that is used as IN by some pro-
 48 cesses and OUT by other processes. Such an argument is, syntactically, an INOUT argument

and is marked as such, although, semantically, it is not used in one call both for input and for output on a single process.

Another frequent situation arises when an argument value is needed only by a subset of the processes. When an argument is not significant at a process then an arbitrary value can be passed as an argument.

Unless specified otherwise, an argument of type OUT or type INOUT cannot be aliased with any other argument passed to an MPI procedure. An example of argument aliasing in C appears below. If we define a C procedure like this,

```
void copyIntBuffer( int *pin, int *pout, int len )
{
    int i;
    for (i=0; i<len; ++i) *pout++ = *pin++;
}
```

then a call to it in the following code fragment has aliased arguments.

```
int a[10];
copyIntBuffer( a, a+3, 7);
```

Although the C language allows this, such usage of MPI procedures is forbidden unless otherwise specified. Note that Fortran prohibits aliasing of arguments.

All MPI functions are first specified in the language-independent notation. Immediately below this, [the ISO C version of the function is shown followed by a version of the same function in Fortran and then the C++ binding.]language dependent bindings follow:

- The ISO C version of the function.
- The Fortran version used with `USE mpi_f08`.
- The Fortran version of the same function used with `USE mpi` or `INCLUDE 'mpif.h'`
- The C++ binding (which is deprecated).

“Fortran” in this document refers to Fortran 90 and higher; see Section 2.6.

2.4 Semantic Terms

When discussing MPI procedures the following semantic terms are used.

nonblocking A procedure is nonblocking if the procedure may return before the operation completes, and before the user is allowed to reuse resources (such as buffers) specified in the call. A nonblocking request is **started** by the call that initiates it, e.g., `MPI_ISEND`. The word complete is used with respect to operations, requests, and communications. An **operation completes** when the user is allowed to reuse resources, and any output buffers have been updated; i.e. a call to `MPI_TEST` will return `flag = true`. A **request is completed** by a call to wait, which returns, or a test or get status call which returns `flag = true`. This completing call has two effects: the status is extracted from the request; in the case of test and wait, if the request was nonpersistent, it is **freed**, and becomes **inactive** if it was persistent. A **communication completes** when all participating operations complete.

1 **blocking** A procedure is blocking if return from the procedure indicates the user is allowed
 2 to reuse resources specified in the call.

3
 4 **local** A procedure is local if completion of the procedure depends only on the local executing
 5 process.

6
 7 **non-local** A procedure is non-local if completion of the operation may require the exe-
 8 cution of some MPI procedure on another process. Such an operation may require
 9 communication occurring with another user process.

10 **collective** A procedure is collective if all processes in a process group need to invoke the
 11 procedure. A collective call may or may not be synchronizing. Collective calls over
 12 the same communicator must be executed in the same order by all members of the
 13 process group.

14
 15 **predefined** A predefined datatype is a datatype with a predefined (constant) name (such
 16 as MPI_INT, MPI_FLOAT_INT, or MPI_UB) or a datatype constructed with
 17 MPI_TYPE_CREATE_F90_INTEGER, MPI_TYPE_CREATE_F90_REAL, or
 18 MPI_TYPE_CREATE_F90_COMPLEX. The former are **named** whereas the latter are
 19 **unnamed**.

20 **derived** A derived datatype is any datatype that is not predefined.

21
 22 **portable** A datatype is portable, if it is a predefined datatype, or it is derived from a
 23 portable datatype using only the type constructors MPI_TYPE_CONTIGUOUS,
 24 MPI_TYPE_VECTOR, MPI_TYPE_INDEXED, MPI_TYPE_CREATE_INDEXED_BLOCK,
 25 MPI_TYPE_CREATE_SUBARRAY, MPI_TYPE_DUP, and MPI_TYPE_CREATE_DARRAY.
 26 Such a datatype is portable because all displacements in the datatype are in terms of
 27 extents of one predefined datatype. Therefore, if such a datatype fits a data layout in
 28 one memory, it will fit the corresponding data layout in another memory, if the same
 29 declarations were used, even if the two systems have different architectures. On the
 30 other hand, if a datatype was constructed using MPI_TYPE_CREATE_HINDEXED,
 31 **MPI_TYPE_CREATE_HINDEXED_BLOCK**, MPI_TYPE_CREATE_HVECTOR or
 32 MPI_TYPE_CREATE_STRUCT, then the datatype contains explicit byte displacements
 33 (e.g., providing padding to meet alignment restrictions). These displacements
 34 are unlikely to be chosen correctly if they fit data layout on one memory, but are
 35 used for data layouts on another process, running on a processor with a different
 36 architecture.

37
 38 **equivalent** Two datatypes are equivalent if they appear to have been created with the same
 39 sequence of calls (and arguments) and thus have the same typemap. Two equivalent
 40 datatypes do not necessarily have the same cached attributes or the same names.

41 2.5 Data Types

42 2.5.1 Opaque Objects

43
 44 MPI manages **system memory** that is used for buffering messages and for storing internal
 45 representations of various MPI objects such as groups, communicators, datatypes, etc. This
 46 memory is not directly accessible to the user, and objects stored there are **opaque**: their
 47
 48

size and shape is not visible to the user. Opaque objects are accessed via **handles**, which exist in user space. MPI procedures that operate on opaque objects are passed handle arguments to access these objects. In addition to their use by MPI calls for object access, handles can participate in assignments and comparisons.

In Fortran with `USE mpi` or `INCLUDE 'mpif.h'`, all handles have type `INTEGER`. In Fortran with `USE mpi_f08`, and in C and C++, a different handle type is defined for each category of objects. With Fortran `USE mpi_f08`, the handles are defined as Fortran `BIND(C)` derived types that consist of only one element `INTEGER :: MPI_VAL`. The internal handle value is identical to the Fortran `INTEGER` value used in the `mpi` module and `mpif.h`. The operators `.EQ.`, `.NE.`, `==` and `/=` are overloaded to allow the comparison of these handles. The type names are identical to the names in C, except that they are not case sensitive. For example:

```
TYPE, BIND(C) :: MPI_Comm
  INTEGER      :: MPI_VAL
END TYPE MPI_Comm
```

In addition, handles themselves are distinct objects in C++. The C and C++ types must support the use of the assignment and equality operators.

Advice to implementors. In Fortran, the handle can be an index into a table of opaque objects in a system table; in C it can be such an index or a pointer to the object. C++ handles can simply “wrap up” a table index or pointer. (*End of advice to implementors.*)

Rationale. Since the Fortran integer values are equivalent, applications can easily convert MPI handles between all three supported Fortran methods. For example, an integer communicator handle `COMM` can be converted directly into an exactly equivalent `mpi_f08` communicator handle named `comm_f08` by `comm_f08%MPI_VAL=COMM`, and vice versa. The use of the `INTEGER` defined handles and the `BIND(C)` derived type handles is different: Fortran 2003 (and later) define that `BIND(C)` derived types can be used within user defined common blocks, but it is up to the rules of the companion C compiler how many numerical storage units are used for these `BIND(C)` derived type handles. Most compilers use one unit for both, the `INTEGER` handles and the handles defined as `BIND(C)` derived types. (*End of rationale.*)

Advice to users. If a user wants to substitute `mpif.h` or the `mpi` module by the `mpi_f08` module and the application program stores a handle in a Fortran common block then it is necessary to change the Fortran support method in all application routines that use this common block, because the number of numerical storage units of such a handle can be different in the two modules. (*End of advice to users.*)

Opaque objects are allocated and deallocated by calls that are specific to each object type. These are listed in the sections where the objects are described. The calls accept a handle argument of matching type. In an allocate call this is an OUT argument that returns a valid reference to the object. In a call to deallocate this is an INOUT argument which returns with an “invalid handle” value. MPI provides an “invalid handle” constant for each object type. Comparisons to this constant are used to test for validity of the handle.

1 A call to a deallocate routine invalidates the handle and marks the object for deal-
2 location. The object is not accessible to the user after the call. However, MPI need not
3 deallocate the object immediately. Any operation pending (at the time of the deallocate)
4 that involves this object will complete normally; the object will be deallocated afterwards.

5 An opaque object and its handle are significant only at the process where the object
6 was created and cannot be transferred to another process.

7 MPI provides certain predefined opaque objects and predefined, static handles to these
8 objects. The user must not free such objects. In C++, this is enforced by declaring the
9 handles to these predefined objects to be `static const`.

10
11 *Rationale.* This design hides the internal representation used for MPI data struc-
12 tures, thus allowing similar calls in C, C++, and Fortran. It also avoids conflicts with
13 the typing rules in these languages, and easily allows future extensions of functionali-
14 ty. The mechanism for opaque objects used here loosely follows the POSIX Fortran
15 binding standard.

16 The explicit separation of handles in user space and objects in system space allows
17 space-reclaiming and deallocation calls to be made at appropriate points in the user
18 program. If the opaque objects were in user space, one would have to be very careful
19 not to go out of scope before any pending operation requiring that object completed.
20 The specified design allows an object to be marked for deallocation, the user program
21 can then go out of scope, and the object itself still persists until any pending operations
22 are complete.

23 The requirement that handles support assignment/comparison is made since such
24 operations are common. This restricts the domain of possible implementations. The
25 alternative would have been to allow handles to have been an arbitrary, opaque type.
26 This would force the introduction of routines to do assignment and comparison, adding
27 complexity, and was therefore ruled out. (*End of rationale.*)

28
29 *Advice to users.* A user may accidentally create a dangling reference by assigning to a
30 handle the value of another handle, and then deallocating the object associated with
31 these handles. Conversely, if a handle variable is deallocated before the associated
32 object is freed, then the object becomes inaccessible (this may occur, for example, if
33 the handle is a local variable within a subroutine, and the subroutine is exited before
34 the associated object is deallocated). It is the user's responsibility to avoid adding or
35 deleting references to opaque objects, except as a result of MPI calls that allocate or
36 deallocate such objects. (*End of advice to users.*)

37
38 *Advice to implementors.* The intended semantics of opaque objects is that opaque
39 objects are separate from one another; each call to allocate such an object copies
40 all the information required for the object. Implementations may avoid excessive
41 copying by substituting referencing for copying. For example, a derived datatype
42 may contain references to its components, rather than copies of its components; a
43 call to `MPI_COMM_GROUP` may return a reference to the group associated with the
44 communicator, rather than a copy of this group. In such cases, the implementation
45 must maintain reference counts, and allocate and deallocate objects in such a way that
46 the visible effect is as if the objects were copied. (*End of advice to implementors.*)
47
48

2.5.2 Array Arguments

An MPI call may need an argument that is an array of opaque objects, or an array of handles. The array-of-handles is a regular array with entries that are handles to objects of the same type in consecutive locations in the array. Whenever such an array is used, an additional `len` argument is required to indicate the number of valid entries (unless this number can be derived otherwise). The valid entries are at the beginning of the array; `len` indicates how many of them there are, and need not be the size of the entire array. The same approach is followed for other array arguments. In some cases `NULL` handles are considered valid entries. When a `NULL` argument is desired for an array of statuses, one uses `MPI_STATUSES_IGNORE`.

2.5.3 State

MPI procedures use at various places arguments with *state* types. The values of such a data type are all identified by names, and no operation is defined on them. For example, the `MPI_TYPE_CREATE_SUBARRAY` routine has a state argument `order` with values `MPI_ORDER_C` and `MPI_ORDER_FORTRAN`.

2.5.4 Named Constants

MPI procedures sometimes assign a special meaning to a special value of a basic type argument; e.g., `tag` is an integer-valued argument of point-to-point communication operations, with a special wild-card value, `MPI_ANY_TAG`. Such arguments will have a range of regular values, which is a proper subrange of the range of values of the corresponding basic type; special values (such as `MPI_ANY_TAG`) will be outside the regular range. The range of regular values, such as `tag`, can be queried using environmental inquiry functions (Chapter 7 of the MPI-1 document). The range of other values, such as `source`, depends on values given by other MPI routines (in the case of `source` it is the communicator size).

MPI also provides predefined named constant handles, such as `MPI_COMM_WORLD`.

All named constants, with the exceptions noted below for Fortran, can be used in initialization expressions or assignments, but not necessarily in array declarations or as labels in C/C++ `switch` or Fortran `select/case` statements. This implies named constants to be link-time but not necessarily compile-time constants. The named constants listed below are required to be compile-time constants in both C/C++ and Fortran. These constants do not change values during execution. Opaque objects accessed by constant handles are defined and do not change value between MPI initialization (`MPI_INIT`) and MPI completion (`MPI_FINALIZE`). The handles themselves are constants and can be also used in initialization expressions or assignments.

The constants that are required to be compile-time constants (and can thus be used for array length declarations and labels in C/C++ `switch` and Fortran `case/select` statements) are:

`MPI_MAX_PROCESSOR_NAME`

1
2
3
4
5
6
7
8
9
10
11
12
13
14
15
16
17
18
19
20
21
22
23
24
25
26
27
28
29
30
31
32
33
34
35
36
37
38
39
40
41
42
43
44
45
46
47
48

ticket204.

1 **MPI_MAX_LIBRARY_VERSION_STRING**
 2 **MPI_MAX_ERROR_STRING**
 3 **MPI_MAX_DATAREP_STRING**
 4 **MPI_MAX_INFO_KEY**
 5 **MPI_MAX_INFO_VAL**
 6 **MPI_MAX_OBJECT_NAME**
 7 **MPI_MAX_PORT_NAME**
 8 **MPI_STATUS_SIZE** (Fortran only)
 ticket265.1. 9 **MPI_ADDRESS_KIND** (Fortran only)
 10 **MPI_COUNT_KIND** (Fortran only)
 11 **MPI_INTEGER_KIND** (Fortran only)
 ticket234-F. 12 **MPI_OFFSET_KIND** (Fortran only)
 ticket238-J. 13 **MPI_SUBARRAYS_SUPPORTED** (Fortran only)
 ticket229.1. 14 **MPI_ASYNC_PROTECTS_NONBLOCKING** (Fortran only)

15 and their C++ counterparts where appropriate.

16 The constants that cannot be used in initialization expressions or assignments in For-
 17 tran are:

18 **MPI_BOTTOM**
 19 **MPI_STATUS_IGNORE**
 20 **MPI_STATUSES_IGNORE**
 21 **MPI_ERRCODES_IGNORE**
 22 **MPI_IN_PLACE**
 23 **MPI_ARGV_NULL**
 24 **MPI_ARGVS_NULL**
 25 **MPI_UNWEIGHTED**

26
 27 *Advice to implementors.* In Fortran the implementation of these special constants
 28 may require the use of language constructs that are outside the Fortran standard.
 29 Using special values for the constants (e.g., by defining them through **PARAMETER**
 30 statements) is not possible because an implementation cannot distinguish these val-
 ticket182. 31 ues from [legal]valid data. Typically, these constants are implemented as predefined
 32 static variables (e.g., a variable in an MPI-declared **COMMON** block), relying on the fact
 33 that the target compiler passes data by address. Inside the subroutine, this address
 34 can be extracted by some mechanism outside the Fortran standard (e.g., by Fortran
 35 extensions or by implementing the function in C). (*End of advice to implementors.*)
 36

37 2.5.5 Choice

38 MPI functions sometimes use arguments with a *choice* (or union) data type. Distinct calls to
 39 the same routine may pass by reference actual arguments of different types. The mechanism
 ticket234-F. 40 for providing such arguments will differ from language to language. For Fortran **with the**
 41 **include file `mpif.h` or the `mpi` module**, the document uses `<type>` to represent a choice
 ticket234-F. 42 variable; **with the Fortran `mpi_f08` module**, such arguments are declared **with the Fortran**
 ticket234-F. 43 **2008 + TR 29113 syntax `TYPE(*)`, `DIMENSION(..)`**; for C and C++, we use `void *`.
 44

45 *Advice to implementors.* Implementors can freely choose how to implement choice
 46 arguments in the `mpi` module, e.g., with a non-standard compiler-dependent method
 47 that has the quality of the call mechanism in the implicit Fortran interfaces, or with
 48

the method defined for the `mpi_f08` module. See details in Section 16.2.1 on page 644. *(End of advice to implementors.)*

2.5.6 Addresses

Some MPI procedures use *address* arguments that represent an absolute address in the calling program. The datatype of such an argument is `MPI_Aint` in C, `MPI::Aint` in C++ and `INTEGER (KIND=MPI_ADDRESS_KIND)` in Fortran. These types must have the same width and encode address values in the same manner such that address values in one language may be passed directly to another language without conversion. There is the MPI constant `MPI_BOTTOM` to indicate the start of the address range.

2.5.7 File Offsets

For I/O there is a need to give the size, displacement, and offset into a file. These quantities can easily be larger than 32 bits which can be the default size of a Fortran integer. To overcome this, these quantities are declared to be `INTEGER (KIND=MPI_OFFSET_KIND)` in Fortran. In C one uses `MPI_Offset` whereas in C++ one uses `MPI::Offset`. These types must have the same width and encode address values in the same manner such that offset values in one language may be passed directly to another language without conversion.

ticket265.

2.5.8 Counts

As described above, MPI defines types (e.g., `MPI_Aint`) to address locations within memory and other types (e.g., `MPI_Offset`) to address locations within files. In addition, some MPI procedures use *count* arguments that represent a number of MPI datatypes on which to operate. At times, one needs a single type that can be used to address locations within either memory or files as well as express *count* values, and that type is `MPI_Count` in C and `INTEGER (KIND=MPI_COUNT_KIND)` in Fortran. These types must have the same width and encode values in the same manner such that count values in one language may be passed directly to another language without conversion. The size of the `MPI_Count` type is determined by the MPI implementation with the restriction that it must be minimally capable of encoding any value that may be stored in a variable of type `int`, `MPI_Aint`, or `MPI_Offset` in C and of type `INTEGER`, `INTEGER (KIND=MPI_ADDRESS_KIND)`, or `INTEGER (KIND=MPI_OFFSET_KIND)` in Fortran.

Rationale. Count values logically need to be large enough to encode any value used for expressing element counts, type maps in memory, type maps in file views, etc. For backward compatibility reasons, many MPI routines still use `int` in C and `INTEGER` in Fortran as the type of count arguments. *(End of rationale.)*

2.6 Language Binding

This section defines the rules for MPI language binding in general and for Fortran, ISO C, and C++, in particular. (Note that ANSI C has been replaced by ISO C.) The C++ language bindings have been deprecated. Defined here are various object representations,

as well as the naming conventions used for expressing this standard. The actual calling sequences are defined elsewhere.

MPI bindings are for Fortran 90 or later, though they [are]were originally designed to be usable in Fortran 77 environments. With the `mpi_f08` module, two new Fortran features, *assumed type* and *assumed rank*, are also required, see Section 2.5.5 on page 16.

Since the word `PARAMETER` is a keyword in the Fortran language, we use the word “argument” to denote the arguments to a subroutine. These are normally referred to as parameters in C and C++, however, we expect that C and C++ programmers will understand the word “argument” (which has no specific meaning in C/C++), thus allowing us to avoid unnecessary confusion for Fortran programmers.

Since Fortran is case insensitive, linkers may use either lower case or upper case when resolving Fortran names. Users of case sensitive languages should avoid the “`mpi_`” and “`pmpi_`” prefixes.

2.6.1 Deprecated and Removed Names and Functions

A number of chapters refer to deprecated or replaced [MPI-1]MPI constructs. These are constructs that continue to be part of the MPI standard, as documented in Chapter 15 on page 621, but that users are recommended not to continue using, since better solutions were provided with [MPI-2]newer versions of MPI. For example, the Fortran binding for MPI-1 functions that have address arguments uses `INTEGER`. This is not consistent with the C binding, and causes problems on machines with 32 bit `INTEGERS` and 64 bit addresses. In MPI-2, these functions were given new names with new bindings for the address arguments. The use of the old functions is deprecated. For consistency, here and in a few other cases, new C functions are also provided, even though the new functions are equivalent to the old functions. The old names are deprecated. Another example is provided by the MPI-1 predefined datatypes `MPI_UB` and `MPI_LB`. They are deprecated, since their use is awkward and error-prone. The MPI-2 function `MPI_TYPE_CREATE_RESIZED` provides a more convenient mechanism to achieve the same effect.

Table 2.1 shows a list of all of the deprecated and removed constructs. Some of the deprecated constructs are now removed, but still listed here and in Chapter ?? on page ?. Note that the constants `MPI_LB` and `MPI_UB` are replaced by the function `MPI_TYPE_CREATE_RESIZED`; this is because their principal use was as input datatypes to `MPI_TYPE_STRUCT` to create resized datatypes. Also note that some C typedefs and Fortran subroutine names are included in this list; they are the types of callback functions.

2.6.2 Fortran Binding Issues

Originally, MPI-1.1 provided bindings for Fortran 77. These bindings are retained, but they are now interpreted in the context of the Fortran 90 standard. MPI can still be used with most Fortran 77 compilers, as noted below. When the term “Fortran” is used it means Fortran 90 or later; it means Fortran 2008 + TR 29113 and later if the `mpi_f08` module is used.

All MPI names have an `MPI_` prefix, and all characters are capitals. Programs must not declare variables, parameters, or functions with names beginning with the prefix `MPI_`. To avoid conflicting with the profiling interface, programs should also avoid functions with the prefix `PMPI_`. This is mandated to avoid possible name collisions.

All MPI Fortran subroutines have a return code in the last argument. With `USE`

[ticket0.341.]

Deprecated or removed construct	deprecated since	removed since	Replacement
MPI_ADDRESS	MPI-2.0		MPI_GET_ADDRESS
MPI_TYPE_HINDEXED	MPI-2.0		MPI_TYPE_CREATE_HINDEXED
MPI_TYPE_HVECTOR	MPI-2.0		MPI_TYPE_CREATE_HVECTOR
MPI_TYPE_STRUCT	MPI-2.0		MPI_TYPE_CREATE_STRUCT
MPI_TYPE_EXTENT	MPI-2.0		MPI_TYPE_GET_EXTENT
MPI_TYPE_UB	MPI-2.0		MPI_TYPE_GET_EXTENT
MPI_TYPE_LB	MPI-2.0		MPI_TYPE_GET_EXTENT
MPI_LB ¹	MPI-2.0		MPI_TYPE_CREATE_RESIZED
MPI_UB ¹	MPI-2.0		MPI_TYPE_CREATE_RESIZED
MPI_ERRHANDLER_CREATE	MPI-2.0		MPI_COMM_CREATE_ERRHANDLER
MPI_ERRHANDLER_GET	MPI-2.0		MPI_COMM_GET_ERRHANDLER
MPI_ERRHANDLER_SET	MPI-2.0		MPI_COMM_SET_ERRHANDLER
MPI_Handler_function ²	MPI-2.0		MPI_Comm_errhandler_function ²
MPI_KEYVAL_CREATE	MPI-2.0		MPI_COMM_CREATE_KEYVAL
MPI_KEYVAL_FREE	MPI-2.0		MPI_COMM_FREE_KEYVAL
MPI_DUP_FN ³	MPI-2.0		MPI_COMM_DUP_FN ³
MPI_NULL_COPY_FN ³	MPI-2.0		MPI_COMM_NULL_COPY_FN ³
MPI_NULL_DELETE_FN ³	MPI-2.0		MPI_COMM_NULL_DELETE_FN ³
MPI_Copy_function ²	MPI-2.0		MPI_Comm_copy_attr_function ²
COPY_FUNCTION ³	MPI-2.0		COMM_COPY_ATTR_[ticket250-V.][FN]FUNCTION ³
MPI_Delete_function ²	MPI-2.0		MPI_Comm_delete_attr_function ²
DELETE_FUNCTION ³	MPI-2.0		COMM_DELETE_ATTR_[ticket250-V.][FN]FUNCTION ³
MPI_ATTR_DELETE	MPI-2.0		MPI_COMM_DELETE_ATTR
MPI_ATTR_GET	MPI-2.0		MPI_COMM_GET_ATTR
MPI_ATTR_PUT	MPI-2.0		MPI_COMM_SET_ATTR
MPI::...	MPI-2.2	MPI-3.0	C language binding
¹ Predefined datatype.			
² Callback prototype definition.			
³ Predefined callback routine.			
Other entries are regular MPI routines.			

Table 2.1: Deprecated [ticket0.341.]and removed constructs

`mpi_f08`, this last argument is declared as `OPTIONAL`, except for user-defined callback functions (e.g., `COMM_COPY_ATTR_FUNCTION`) and their predefined callbacks (e.g., `MPI_NULL_COPY_FN`). A few MPI operations which are functions do not have the return code argument. The return code value for successful completion is `MPI_SUCCESS`. Other error codes are implementation dependent; see the error codes in Chapter 8 and Annex A.

Constants representing the maximum length of a string are one smaller in Fortran than in C and C++ as discussed in Section 16.3.9.

Handles are represented in Fortran as `INTEGERS`, or as a `BIND(C)` derived type with the `mpi_f08` module; see Section 2.5.1 on page 12. Binary-valued variables are of type `LOGICAL`.

Array arguments are indexed from one.

The older MPI Fortran binding [is]s (`mpif.h` and `use mpi`) are inconsistent with the Fortran [90] standard in several respects. These inconsistencies, such as register optimization problems, have implications for user codes that are discussed in detail in Section 16.2.16.

ticket230-B. ¹ [They are also inconsistent with Fortran 77.]

2.6.3 C Binding Issues

We use the ISO C declaration format. All MPI names have an MPI_ prefix, defined constants are in all capital letters, and defined types and functions have one capital letter after the prefix. Programs must not declare variables or functions with names beginning with the prefix MPI_. To support the profiling interface, programs should not declare functions with names beginning with the prefix PMPI_.

The definition of named constants, function prototypes, and type definitions must be supplied in an include file mpi.h.

Almost all C functions return an error code. The successful return code will be MPI_SUCCESS, but failure return codes are implementation dependent.

Type declarations are provided for handles to each category of opaque objects.

Array arguments are indexed from zero.

Logical flags are integers with value 0 meaning “false” and a non-zero value meaning “true.”

Choice arguments are pointers of type void *.

Address arguments are of MPI defined type MPI_Aint. File displacements are of type MPI_Offset. MPI_Aint is defined to be an integer of the size needed to hold any valid address on the target architecture. MPI_Offset is defined to be an integer of the size needed to hold any valid file size on the target architecture.

2.6.4 C++ Binding Issues

The C++ language bindings have been deprecated. There are places in the standard that give rules for C and not for C++. In these cases, the C rule should be applied to the C++ case, as appropriate. In particular, the values of constants given in the text are the ones for C and Fortran. A cross index of these with the C++ names is given in Annex A.

We use the ISO C++ declaration format. All MPI names are declared within the scope of a namespace called MPI and therefore are referenced with an MPI:: prefix. Defined constants are in all capital letters, and class names, defined types, and functions have only their first letter capitalized. Programs must not declare variables or functions in the MPI namespace. This is mandated to avoid possible name collisions.

The definition of named constants, function prototypes, and type definitions must be supplied in an include file mpi.h.

Advice to implementors. The file mpi.h may contain both the C and C++ definitions. Usually one can simply use the defined value (generally __cplusplus, but not required) to see if one is using C++ to protect the C++ definitions. It is possible that a C compiler will require that the source protected this way be [legal]valid C code. In this case, all the C++ definitions can be placed in a different include file and the “#include” directive can be used to include the necessary C++ definitions in the mpi.h file. (*End of advice to implementors.*)

C++ functions that create objects or return information usually place the object or information in the return value. Since the language neutral prototypes of MPI functions include the C++ return value as an OUT parameter, semantic descriptions of MPI functions

refer to the C++ return value by that parameter name. The remaining C++ functions return `void`.

In some circumstances, MPI permits users to indicate that they do not want a return value. For example, the user may indicate that the status is not filled in. Unlike C and Fortran where this is achieved through a special input value, in C++ this is done by having two bindings where one has the optional argument and one does not.

C++ functions do not return error codes. If the default error handler has been set to `MPI::ERRORS_THROW_EXCEPTIONS`, the C++ exception mechanism is used to signal an error by throwing an `MPI::Exception` object.

It should be noted that the default error handler (i.e., `MPI::ERRORS_ARE_FATAL`) on a given type has not changed. User error handlers are also permitted. `MPI::ERRORS_RETURN` simply returns control to the calling function; there is no provision for the user to retrieve the error code.

User callback functions that return integer error codes should not throw exceptions; the returned error will be handled by the MPI implementation by invoking the appropriate error handler.

Advice to users. C++ programmers that want to handle MPI errors on their own should use the `MPI::ERRORS_THROW_EXCEPTIONS` error handler, rather than `MPI::ERRORS_RETURN`, that is used for that purpose in C. Care should be taken using exceptions in mixed language situations. (*End of advice to users.*)

Opaque object handles must be objects in themselves, and have the assignment and equality operators overridden to perform semantically like their C and Fortran counterparts.

Array arguments are indexed from zero.

Logical flags are of type `bool`.

Choice arguments are pointers of type `void *`.

Address arguments are of MPI-defined integer type `MPI::Aint`, defined to be an integer of the size needed to hold any valid address on the target architecture. Analogously, `MPI::Offset` is an integer to hold file offsets.

Most MPI functions are methods of MPI C++ classes. MPI class names are generated from the language neutral MPI types by dropping the `MPI_` prefix and scoping the type within the MPI namespace. For example, `MPI_DATATYPE` becomes `MPI::Datatype`.

The names of MPI functions generally follow the naming rules given. In some circumstances, the MPI function is related to a function defined already for MPI-1 with a name that does not follow the naming conventions. In this circumstance, the language neutral name is in analogy to the MPI name even though this gives an MPI-2 name that violates the naming conventions. The C and Fortran names are the same as the language neutral name in this case. However, the C++ names do reflect the naming rules and can differ from the C and Fortran names. Thus, the analogous name in C++ to the MPI name may be different than the language neutral name. This results in the C++ name differing from the language neutral name. An example of this is the language neutral name of `MPI_FINALIZED` and a C++ name of `MPI::Is_finalized`.

In C++, function `typedefs` are made publicly within appropriate classes. However, these declarations then become somewhat cumbersome, as with the following:

```
{typedef MPI::Grequest::Query_function(); (binding deprecated, see Section 15.2)}
```

would look like the following:

```

1 namespace MPI {
2     class Request {
3         // ...
4     };
5
6     class Grequest : public MPI::Request {
7         // ...
8         typedef Query_function(void* extra_state, MPI::Status& status);
9     };
10 };
11

```

12 Rather than including this scaffolding when declaring C++ typedefs, we use an abbreviated
13 form. In particular, we explicitly indicate the class and namespace scope for the typedef
14 of the function. Thus, the example above is shown in the text as follows:

```

15 typedef int MPI::Grequest::Query_function(void* extra_state,
16                                           MPI::Status& status)
17

```

18 The C++ bindings presented in Annex A.5 and throughout this document were gener-
19 ated by applying a simple set of name generation rules to the MPI function specifications.
20 While these guidelines may be sufficient in most cases, they may not be suitable for all
21 situations. In cases of ambiguity or where a specific semantic statement is desired, these
22 guidelines may be superseded as the situation dictates.

- 24 1. All functions, types, and constants are declared within the scope of a namespace called
25 MPI.
- 26 2. Arrays of MPI handles are always left in the argument list (whether they are IN or
27 OUT arguments).
- 28 3. If the argument list of an MPI function contains a scalar IN handle, and it makes sense
29 to define the function as a method of the object corresponding to that handle, the
30 function is made a member function of the corresponding MPI class. The member
31 functions are named according to the corresponding MPI function name, but without
32 the “MPI_” prefix and without the object name prefix (if applicable). In addition:
33 (a) The scalar IN handle is dropped from the argument list, and **this** corresponds
34 to the dropped argument.
35 (b) The function is declared **const**.
- 36 4. MPI functions are made into class functions (static) when they belong on a class but
37 do not have a unique scalar IN or INOUT parameter of that class.
- 38 5. If the argument list contains a single OUT argument that is not of type MPI_STATUS
39 (or an array), that argument is dropped from the list and the function returns that
40 value.

41
42
43 **Example 2.1** The C++ binding for MPI_COMM_SIZE is
44 int MPI::Comm::Get_size(void) const.

6. If there are multiple OUT arguments in the argument list, one is chosen as the return value and is removed from the list.
7. If the argument list does not contain any OUT arguments, the function returns `void`.

Example 2.2 The C++ binding for `MPI_REQUEST_FREE` is
`void MPI::Request::Free(void)`

8. MPI functions to which the above rules do not apply are not members of any class, but are defined in the MPI namespace.

Example 2.3 The C++ binding for `MPI_BUFFER_ATTACH` is
`void MPI::Attach_buffer(void* buffer, int size).`

9. All class names, defined types, and function names have only their first letter capitalized. Defined constants are in all capital letters.
10. Any IN pointer, reference, or array argument must be declared `const`.
11. Handles are passed by reference.
12. Array arguments are denoted with square brackets (`[]`), not pointers, as this is more semantically precise.

2.6.5 Functions and Macros

An implementation is allowed to implement `MPI_WTIME`, `MPI_WTICK`, `PMPI_WTIME`, `PMPI_WTICK`, and the handle-conversion functions (`MPI_Group_f2c`, etc.) in Section 16.3.4, and no others, as macros in C.

Advice to implementors. Implementors should document which routines are implemented as macros. (*End of advice to implementors.*)

Advice to users. If these routines are implemented as macros, they will not work with the MPI profiling interface. (*End of advice to users.*)

2.7 Processes

An MPI program consists of autonomous processes, executing their own code, in an MIMD style. The codes executed by each process need not be identical. The processes communicate via calls to MPI communication primitives. Typically, each process executes in its own address space, although shared-memory implementations of MPI are possible.

This document specifies the behavior of a parallel program assuming that only MPI calls are used. The interaction of an MPI program with other possible means of communication, I/O, and process management is not specified. Unless otherwise stated in the specification of the standard, MPI places no requirements on the result of its interaction with external mechanisms that provide similar or equivalent functionality. This includes, but is not limited to, interactions with external mechanisms for process control, shared and remote memory access, file system access and control, interprocess communication, process signaling, and terminal I/O. High quality implementations should strive to make the results

1 of such interactions intuitive to users, and attempt to document restrictions where deemed
2 necessary.

3
4 *Advice to implementors.* Implementations that support such additional mechanisms
5 for functionality supported within MPI are expected to document how these interact
6 with MPI. (*End of advice to implementors.*)

7
8 The interaction of MPI and threads is defined in Section 12.4.

10 2.8 Error Handling

11
12 MPI provides the user with reliable message transmission. A message sent is always received
13 correctly, and the user does not need to check for transmission errors, time-outs, or other
14 error conditions. In other words, MPI does not provide mechanisms for dealing with failures
15 in the communication system. If the MPI implementation is built on an unreliable underlying
16 mechanism, then it is the job of the implementor of the MPI subsystem to insulate the
17 user from this unreliability, or to reflect unrecoverable errors as failures. Whenever possible,
18 such failures will be reflected as errors in the relevant communication call. Similarly, MPI
19 itself provides no mechanisms for handling processor failures.

20 Of course, MPI programs may still be erroneous. A **program error** can occur when
21 an MPI call is made with an incorrect argument (non-existing destination in a send oper-
22 ation, buffer too small in a receive operation, etc.). This type of error would occur in any
23 implementation. In addition, a **resource error** may occur when a program exceeds the
24 amount of available system resources (number of pending messages, system buffers, etc.).
25 The occurrence of this type of error depends on the amount of available resources in the
26 system and the resource allocation mechanism used; this may differ from system to system.
27 A high-quality implementation will provide generous limits on the important resources so
28 as to alleviate the portability problem this represents.

29 In C and Fortran, almost all MPI calls return a code that indicates successful completion
30 of the operation. Whenever possible, MPI calls return an error code if an error occurred
31 during the call. By default, an error detected during the execution of the MPI library
32 causes the parallel computation to abort, except for file operations. However, MPI provides
33 mechanisms for users to change this default and to handle recoverable errors. The user
34 may specify that no error is fatal, and handle error codes returned by MPI calls by himself
35 or herself. Also, the user may provide his or her own error-handling routines, which will
36 be invoked whenever an MPI call returns abnormally. The MPI error handling facilities
37 are described in Section 8.3. The return values of C++ functions are not error codes.
38 If the default error handler has been set to `MPI::ERRORS_THROW_EXCEPTIONS`, the C++
39 exception mechanism is used to signal an error by throwing an `MPI::Exception` object. See
40 also Section 16.1.8 on page 640.

41 Several factors limit the ability of MPI calls to return with meaningful error codes
42 when an error occurs. MPI may not be able to detect some errors; other errors may be too
43 expensive to detect in normal execution mode; finally some errors may be “catastrophic”
44 and may prevent MPI from returning control to the caller in a consistent state.

45 Another subtle issue arises because of the nature of asynchronous communications: MPI
46 calls may initiate operations that continue asynchronously after the call returned. Thus, the
47 operation may return with a code indicating successful completion, yet later cause an error
48 exception to be raised. If there is a subsequent call that relates to the same operation (e.g.,

a call that verifies that an asynchronous operation has completed) then the error argument associated with this call will be used to indicate the nature of the error. In a few cases, the error may occur after all calls that relate to the operation have completed, so that no error value can be used to indicate the nature of the error (e.g., an error on the receiver in a send with the ready mode). Such an error must be treated as fatal, since information cannot be returned for the user to recover from it.

This document does not specify the state of a computation after an erroneous MPI call has occurred. The desired behavior is that a relevant error code be returned, and the effect of the error be localized to the greatest possible extent. E.g., it is highly desirable that an erroneous receive call will not cause any part of the receiver's memory to be overwritten, beyond the area specified for receiving the message.

Implementations may go beyond this document in supporting in a meaningful manner MPI calls that are defined here to be erroneous. For example, MPI specifies strict type matching rules between matching send and receive operations: it is erroneous to send a floating point variable and receive an integer. Implementations may go beyond these type matching rules, and provide automatic type conversion in such situations. It will be helpful to generate warnings for such non-conforming behavior.

MPI defines a way for users to create new error codes as defined in Section 8.5.

2.9 Implementation Issues

There are a number of areas where an MPI implementation may interact with the operating environment and system. While MPI does not mandate that any services (such as signal handling) be provided, it does strongly suggest the behavior to be provided if those services are available. This is an important point in achieving portability across platforms that provide the same set of services.

2.9.1 Independence of Basic Runtime Routines

MPI programs require that library routines that are part of the basic language environment (such as `write` in Fortran and `printf` and `malloc` in ISO C) and are executed after `MPI_INIT` and before `MPI_FINALIZE` operate independently and that their *completion* is independent of the action of other processes in an MPI program.

Note that this in no way prevents the creation of library routines that provide parallel services whose operation is collective. However, the following program is expected to complete in an ISO C environment regardless of the size of `MPI_COMM_WORLD` (assuming that `printf` is available at the executing nodes).

```
int rank;
MPI_Init((void *)0, (void *)0);
MPI_Comm_rank(MPI_COMM_WORLD, &rank);
if (rank == 0) printf("Starting program\n");
MPI_Finalize();
```

The corresponding Fortran and C++ programs are also expected to complete.

An example of what is *not* required is any particular ordering of the action of these routines when called by several tasks. For example, MPI makes neither requirements nor recommendations for the output from the following program (again assuming that I/O is available at the executing nodes).

```
1 MPI_Comm_rank(MPI_COMM_WORLD, &rank);  
2 printf("Output from task rank %d\n", rank);  
3
```

4 In addition, calls that fail because of resource exhaustion or other error are not con-
5 sidered a violation of the requirements here (however, they are required to complete, just
6 not to complete successfully).

7 8 2.9.2 Interaction with Signals

9 MPI does not specify the interaction of processes with signals and does not require that MPI
10 be signal safe. The implementation may reserve some signals for its own use. It is required
11 that the implementation document which signals it uses, and it is strongly recommended
12 that it not use SIGALRM, SIGFPE, or SIGIO. Implementations may also prohibit the use of
13 MPI calls from within signal handlers.

14 In multithreaded environments, users can avoid conflicts between signals and the MPI
15 library by catching signals only on threads that do not execute MPI calls. High quality
16 single-threaded implementations will be signal safe: an MPI call suspended by a signal will
17 resume and complete normally after the signal is handled.
18

19 20 2.10 Examples

21 The examples in this document are for illustration purposes only. They are not intended
22 to specify the standard. Furthermore, the examples have not been carefully checked or
23 verified.
24
25
26
27
28
29
30
31
32
33
34
35
36
37
38
39
40
41
42
43
44
45
46
47
48

Chapter 3

Point-to-Point Communication

3.1 Introduction

Sending and receiving of messages by processes is the basic MPI communication mechanism. The basic point-to-point communication operations are **send** and **receive**. Their use is illustrated in the example below.

```
#include "mpi.h"
int main( int argc, char **argv )
{
    char message[20];
    int myrank;
    MPI_Status status;
    MPI_Init( &argc, &argv );
    MPI_Comm_rank( MPI_COMM_WORLD, &myrank );
    if (myrank == 0) /* code for process zero */
    {
        strcpy(message,"Hello, there");
        MPI_Send(message, strlen(message)+1, MPI_CHAR, 1, 99, MPI_COMM_WORLD);
    }
    else if (myrank == 1) /* code for process one */
    {
        MPI_Recv(message, 20, MPI_CHAR, 0, 99, MPI_COMM_WORLD, &status);
        printf("received :%s:\n", message);
    }
    MPI_Finalize();
    return 0;
}
```

In this example, process zero (`myrank = 0`) sends a message to process one using the **send** operation `MPI_SEND`. The operation specifies a **send buffer** in the sender memory from which the message data is taken. In the example above, the send buffer consists of the storage containing the variable `message` in the memory of process zero. The location, size and type of the send buffer are specified by the first three parameters of the send operation. The message sent will contain the 13 characters of this variable. In addition, the send operation associates an **envelope** with the message. This envelope specifies the

1 message destination and contains distinguishing information that can be used by the **receive**
 2 operation to select a particular message. The last three parameters of the send operation,
 3 along with the rank of the sender, specify the envelope for the message sent. Process one
 4 (**myrank = 1**) receives this message with the **receive** operation **MPI_RECV**. The message to
 5 be received is selected according to the value of its envelope, and the message data is stored
 6 into the **receive buffer**. In the example above, the receive buffer consists of the storage
 7 containing the string **message** in the memory of process one. The first three parameters
 8 of the receive operation specify the location, size and type of the receive buffer. The next
 9 three parameters are used for selecting the incoming message. The last parameter is used
 10 to return information on the message just received.

11 The next sections describe the blocking send and receive operations. We discuss send,
 12 receive, blocking communication semantics, type matching requirements, type conversion in
 13 heterogeneous environments, and more general communication modes. Nonblocking com-
 14 munication is addressed next, followed by **probing and canceling a message**, channel-like
 15 constructs and send-receive operations, [**Nonblocking communication is addressed next,**
 16 **followed by channel-like constructs and send-receive operations,**] ending with a description
 17 of the “dummy” process, **MPI_PROC_NULL**.

19 3.2 Blocking Send and Receive Operations

21 3.2.1 Blocking Send

23 The syntax of the blocking send operation is given below.

25 **MPI_SEND**(buf, count, datatype, dest, tag, comm)

27	IN	buf	initial address of send buffer (choice)
28	IN	count	number of elements in send buffer (non-negative inte- 29 ger)
30	IN	datatype	datatype of each send buffer element (handle)
31	IN	dest	rank of destination (integer)
32	IN	tag	message tag (integer)
33	IN	tag	message tag (integer)
34	IN	comm	communicator (handle)
35	IN	comm	communicator (handle)

36
 ticket140. 37 **int MPI_Send**(**const** void* buf, int count, MPI_Datatype datatype, int dest,
 38 int tag, MPI_Comm comm)

ticket-248T. 39 **MPI_Send**(buf, count, datatype, dest, tag, comm, ierror) **BIND(C)**
 40 **TYPE(*), DIMENSION(..), INTENT(IN) :: buf**
 41 **INTEGER, INTENT(IN) :: count, dest, tag**
 42 **TYPE(MPI_Datatype), INTENT(IN) :: datatype**
 43 **TYPE(MPI_Comm), INTENT(IN) :: comm**
 44 **INTEGER, OPTIONAL, INTENT(OUT) :: ierror**

45
 46 **MPI_SEND**(BUF, COUNT, DATATYPE, DEST, TAG, COMM, IERROR)
 47 <type> BUF(*)
 48 INTEGER COUNT, DATATYPE, DEST, TAG, COMM, IERROR

```
{void MPI::Comm::Send(const void* buf, int count, const
    MPI::Datatype& datatype, int dest, int tag) const(binding
    deprecated, see Section 15.2) }
```

The blocking semantics of this call are described in Section 3.4.

3.2.2 Message Data

The send buffer specified by the MPI_SEND operation consists of `count` successive entries of the type indicated by `datatype`, starting with the entry at address `buf`. Note that we specify the message length in terms of number of *elements*, not number of *bytes*. The former is machine independent and closer to the application level.

The data part of the message consists of a sequence of `count` values, each of the type indicated by `datatype`. `count` may be zero, in which case the data part of the message is empty. The basic datatypes that can be specified for message data values correspond to the basic datatypes of the host language. Possible values of this argument for Fortran and the corresponding Fortran types are listed in Table 3.1.

MPI datatype	Fortran datatype
MPI_INTEGER	INTEGER
MPI_REAL	REAL
MPI_DOUBLE_PRECISION	DOUBLE PRECISION
MPI_COMPLEX	COMPLEX
MPI_LOGICAL	LOGICAL
MPI_CHARACTER	CHARACTER(1)
MPI_BYTE	
MPI_PACKED	

Table 3.1: Predefined MPI datatypes corresponding to Fortran datatypes

Possible values for this argument for C and the corresponding C types are listed in Table 3.2.

The datatypes MPI_BYTE and MPI_PACKED do not correspond to a Fortran or C datatype. A value of type MPI_BYTE consists of a byte (8 binary digits). A byte is uninterpreted and is different from a character. Different machines may have different representations for characters, or may use more than one byte to represent characters. On the other hand, a byte has the same binary value on all machines. The use of the type MPI_PACKED is explained in Section 4.2.

MPI requires support of these datatypes, which match the basic datatypes of Fortran and ISO C. Additional MPI datatypes should be provided if the host language has additional data types: MPI_DOUBLE_COMPLEX for double precision complex in Fortran declared to be of type DOUBLE COMPLEX; MPI_REAL2, MPI_REAL4 and MPI_REAL8 for Fortran reals, declared to be of type REAL*2, REAL*4 and REAL*8, respectively; MPI_INTEGER1, MPI_INTEGER2 and MPI_INTEGER4 for Fortran integers, declared to be of type INTEGER*1, INTEGER*2 and INTEGER*4, respectively; etc.

Rationale. One goal of the design is to allow for MPI to be implemented as a library, with no need for additional preprocessing or compilation. Thus, one cannot assume that a communication call has information on the datatype of variables in the

MPI datatype	C datatype
MPI_CHAR	char (treated as printable character)
MPI_SHORT	signed short int
MPI_INT	signed int
MPI_LONG	signed long int
MPI_LONG_LONG_INT	signed long long int
MPI_LONG_LONG (as a synonym)	signed long long int
MPI_SIGNED_CHAR	signed char (treated as integral value)
MPI_UNSIGNED_CHAR	unsigned char (treated as integral value)
MPI_UNSIGNED_SHORT	unsigned short int
MPI_UNSIGNED	unsigned int
MPI_UNSIGNED_LONG	unsigned long int
MPI_UNSIGNED_LONG_LONG	unsigned long long int
MPI_FLOAT	float
MPI_DOUBLE	double
MPI_LONG_DOUBLE	long double
MPI_WCHAR	wchar_t (defined in <stddef.h> (treated as printable character)
MPI_C_BOOL	_Bool
MPI_INT8_T	int8_t
MPI_INT16_T	int16_t
MPI_INT32_T	int32_t
MPI_INT64_T	int64_t
MPI_UINT8_T	uint8_t
MPI_UINT16_T	uint16_t
MPI_UINT32_T	uint32_t
MPI_UINT64_T	uint64_t
MPI_C_COMPLEX	float _Complex
MPI_C_FLOAT_COMPLEX (as a synonym)	float _Complex
MPI_C_DOUBLE_COMPLEX	double _Complex
MPI_C_LONG_DOUBLE_COMPLEX	long double _Complex
MPI_BYTE	
MPI_PACKED	

Table 3.2: Predefined MPI datatypes corresponding to C datatypes

communication buffer; this information must be supplied by an explicit argument. The need for such datatype information will become clear in Section 3.3.2. (*End of rationale.*)

Rationale. The datatypes MPI_C_BOOL, MPI_INT8_T, MPI_INT16_T, MPI_INT32_T, MPI_UINT8_T, MPI_UINT16_T, MPI_UINT32_T, MPI_C_COMPLEX, MPI_C_FLOAT_COMPLEX, MPI_C_DOUBLE_COMPLEX, and

MPI datatype	C datatype	Fortran datatype	
MPI_AINT	MPI_Aint	INTEGER (KIND=MPI_ADDRESS_KIND)	1
MPI_OFFSET	MPI_Offset	INTEGER (KIND=MPI_OFFSET_KIND)	2
[ticket265.]MPI_COUNT	[ticket265.]MPI_Count	[ticket265.]INTEGER (KIND=MPI_COUNT_KIND)	3

Table 3.3: Predefined MPI datatypes corresponding to both C and Fortran datatypes

MPI_C_LONG_DOUBLE_COMPLEX have no corresponding C++ bindings. This was intentionally done to avoid potential collisions with the C preprocessor and namespace C++ names. C++ applications can use the C bindings with no loss of functionality. (*End of rationale.*)

The datatypes MPI_AINT [and], MPI_OFFSET [], and MPI_COUNT correspond to the MPI-defined C types MPI_Aint [and], MPI_Offset [], and MPI_Count and their Fortran equivalents INTEGER (KIND=MPI_ADDRESS_KIND) [and], INTEGER (KIND=MPI_OFFSET_KIND), and INTEGER (KIND=MPI_COUNT_KIND). This is described in Table 3.3. See Section 16.3.10 for information on interlanguage communication with these types.

3.2.3 Message Envelope

In addition to the data part, messages carry information that can be used to distinguish messages and selectively receive them. This information consists of a fixed number of fields, which we collectively call the **message envelope**. These fields are

source
destination
tag
communicator

The message source is implicitly determined by the identity of the message sender. The other fields are specified by arguments in the send operation.

The message destination is specified by the **dest** argument.

The integer-valued message tag is specified by the **tag** argument. This integer can be used by the program to distinguish different types of messages. The range of valid tag values is 0,...,UB, where the value of UB is implementation dependent. It can be found by querying the value of the attribute MPI_TAG_UB, as described in Chapter 8. MPI requires that UB be no less than 32767.

The **comm** argument specifies the **communicator** that is used for the send operation. Communicators are explained in Chapter 6; below is a brief summary of their usage.

A communicator specifies the communication context for a communication operation. Each communication context provides a separate “communication universe[:]” [:]: messages are always received within the context they were sent, and messages sent in different contexts do not interfere.

The communicator also specifies the set of processes that share this communication context. This **process group** is ordered and processes are identified by their rank within this group. Thus, the range of valid values for **dest** is 0, ... , n-1, where n is the number of

processes in the group. (If the communicator is an inter-communicator, then destinations are identified by their rank in the remote group. See Chapter 6.)

A predefined communicator `MPI_COMM_WORLD` is provided by MPI. It allows communication with all processes that are accessible after MPI initialization and processes are identified by their rank in the group of `MPI_COMM_WORLD`.

Advice to users. Users that are comfortable with the notion of a flat name space for processes, and a single communication context, as offered by most existing communication libraries, need only use the predefined variable `MPI_COMM_WORLD` as the `comm` argument. This will allow communication with all the processes available at initialization time.

Users may define new communicators, as explained in Chapter 6. Communicators provide an important encapsulation mechanism for libraries and modules. They allow modules to have their own disjoint communication universe and their own process numbering scheme. (*End of advice to users.*)

Advice to implementors. The message envelope would normally be encoded by a fixed-length message header. However, the actual encoding is implementation dependent. Some of the information (e.g., source or destination) may be implicit, and need not be explicitly carried by messages. Also, processes may be identified by relative ranks, or absolute ids, etc. (*End of advice to implementors.*)

3.2.4 Blocking Receive

The syntax of the blocking receive operation is given below.

`MPI_RECV (buf, count, datatype, source, tag, comm, status)`

OUT	buf	initial address of receive buffer (choice)
IN	count	number of elements in receive buffer (non-negative integer)
IN	datatype	datatype of each receive buffer element (handle)
IN	source	rank of source or <code>MPI_ANY_SOURCE</code> (integer)
IN	tag	message tag or <code>MPI_ANY_TAG</code> (integer)
IN	comm	communicator (handle)
OUT	status	status object (<code>Status</code>)

```
int MPI_Recv(void* buf, int count, MPI_Datatype datatype, int source,
            int tag, MPI_Comm comm, MPI_Status *status)
```

```
MPI_Recv(buf, count, datatype, source, tag, comm, status, ierror) BIND(C)
    TYPE(*), DIMENSION(..) :: buf
    INTEGER, INTENT(IN) :: count, source, tag
    TYPE(MPI_Datatype), INTENT(IN) :: datatype
    TYPE(MPI_Comm), INTENT(IN) :: comm
    TYPE(MPI_Status) :: status
```

INTEGER, OPTIONAL, INTENT(OUT) :: ierror

```
MPI_RECV(BUF, COUNT, DATATYPE, SOURCE, TAG, COMM, STATUS, IERROR)
<type> BUF(*)
INTEGER COUNT, DATATYPE, SOURCE, TAG, COMM, STATUS(MPI_STATUS_SIZE),
IERROR
```

```
{void MPI::Comm::Recv(void* buf, int count, const MPI::Datatype& datatype,
    int source, int tag, MPI::Status& status) const(binding
    deprecated, see Section 15.2) }
```

```
{void MPI::Comm::Recv(void* buf, int count, const MPI::Datatype& datatype,
    int source, int tag) const(binding deprecated, see Section 15.2) }
```

The blocking semantics of this call are described in Section 3.4.

The receive buffer consists of the storage containing `count` consecutive elements of the type specified by `datatype`, starting at address `buf`. The length of the received message must be less than or equal to the length of the receive buffer. An overflow error occurs if all incoming data does not fit, without truncation, into the receive buffer.

If a message that is shorter than the receive buffer arrives, then only those locations corresponding to the (shorter) message are modified.

Advice to users. The `MPI_PROBE` function described in Section 3.8 can be used to receive messages of unknown length. (*End of advice to users.*)

Advice to implementors. Even though no specific behavior is mandated by MPI for erroneous programs, the recommended handling of overflow situations is to return in `status` information about the source and tag of the incoming message. The receive operation will return an error code. A quality implementation will also ensure that no memory that is outside the receive buffer will ever be overwritten.

In the case of a message shorter than the receive buffer, MPI is quite strict in that it allows no modification of the other locations. A more lenient statement would allow for some optimizations but this is not allowed. The implementation must be ready to end a copy into the receiver memory exactly at the end of the receive buffer, even if it is an odd address. (*End of advice to implementors.*)

The selection of a message by a receive operation is governed by the value of the message envelope. A message can be received by a receive operation if its envelope matches the `source`, `tag` and `comm` values specified by the receive operation. The receiver may specify a wildcard `MPI_ANY_SOURCE` value for `source`, and/or a wildcard `MPI_ANY_TAG` value for `tag`, indicating that any source and/or tag are acceptable. It cannot specify a wildcard value for `comm`. Thus, a message can be received by a receive operation only if it is addressed to the receiving process, has a matching communicator, has matching source unless `source=MPI_ANY_SOURCE` in the pattern, and has a matching tag unless `tag=MPI_ANY_TAG` in the pattern.

The message tag is specified by the `tag` argument of the receive operation. The argument `source`, if different from `MPI_ANY_SOURCE`, is specified as a rank within the process group associated with that same communicator (remote process group, for intercommunicators). Thus, the range of valid values for the `source` argument is $\{0, \dots, n-1\} \cup \{MPI_ANY_SOURCE\}$, where `n` is the number of processes in this group.

Note the asymmetry between send and receive operations: A receive operation may accept messages from an arbitrary sender, on the other hand, a send operation must specify a unique receiver. This matches a “push” communication mechanism, where data transfer is effected by the sender (rather than a “pull” mechanism, where data transfer is effected by the receiver).

Source = destination is allowed, that is, a process can send a message to itself. (However, it is unsafe to do so with the blocking send and receive operations described above, since this may lead to deadlock. See Section 3.5.)

Advice to implementors. Message context and other communicator information can be implemented as an additional tag field. It differs from the regular message tag in that wild card matching is not allowed on this field, and that value setting for this field is controlled by communicator manipulation functions. (*End of advice to implementors.*)

3.2.5 Return Status

The source or tag of a received message may not be known if wildcard values were used in the receive operation. Also, if multiple requests are completed by a single MPI function (see Section 3.7.5), a distinct error code may need to be returned for each request. The information is returned by the `status` argument of `MPI_RECV`. The type of `status` is MPI-defined. Status variables need to be explicitly allocated by the user, that is, they are not system objects.

In C, `status` is a structure that contains three fields named `MPI_SOURCE`, `MPI_TAG`, and `MPI_ERROR`; the structure may contain additional fields. Thus, `status.MPI_SOURCE`, `status.MPI_TAG` and `status.MPI_ERROR` contain the source, tag, and error code, respectively, of the received message.

In Fortran with `USE mpi` or `INCLUDE 'mpif.h'`, `status` is an array of `INTEGER`s of size `MPI_STATUS_SIZE`. The constants `MPI_SOURCE`, `MPI_TAG` and `MPI_ERROR` are the indices of the entries that store the source, tag and error fields. Thus, `status(MPI_SOURCE)`, `status(MPI_TAG)` and `status(MPI_ERROR)` contain, respectively, the source, tag and error code of the received message.

With Fortran `USE mpi_f08`, `status` is defined as the Fortran `BIND(C)` derived type `TYPE(MPI_Status)` containing three public fields named `MPI_SOURCE`, `MPI_TAG`, and `MPI_ERROR`. `TYPE(MPI_Status)` may contain additional, implementation-specific fields. Thus, `status%MPI_SOURCE`, `status%MPI_TAG` and `status%MPI_ERROR` contain the source, tag, and error code of a received message respectively. Additionally, within both the `mpi` and the `mpi_f08` modules, the constants `MPI_STATUS_SIZE`, `MPI_SOURCE`, `MPI_TAG`, `MPI_ERROR`, and `TYPE(MPI_Status)` are defined to allow conversion between both `status` representations. Conversion routines are provided in Section 16.3.5 on page 700.

Rationale. The Fortran `TYPE(MPI_Status)` is defined as a `BIND(C)` derived type so that it can be used at any location where the status integer array representation can be used, e.g., in user defined common blocks. (*End of rationale.*)

Rationale. It is allowed to have the same name (e.g., `MPI_SOURCE`) defined as a constant (e.g., Fortran parameter) and as a field of a derived type. (*End of rationale.*)

In C++, the `status` object is handled through the following methods:

```

{int MPI::Status::Get_source() const(binding deprecated, see Section 15.2) }
{void MPI::Status::Set_source(int source)(binding deprecated, see Section 15.2) }
{int MPI::Status::Get_tag() const(binding deprecated, see Section 15.2) }
{void MPI::Status::Set_tag(int tag)(binding deprecated, see Section 15.2) }
{int MPI::Status::Get_error() const(binding deprecated, see Section 15.2) }
{void MPI::Status::Set_error(int error)(binding deprecated, see Section 15.2) }

```

In general, message-passing calls do not modify the value of the error code field of status variables. This field may be updated only by the functions in Section 3.7.5 which return multiple statuses. The field is updated if and only if such function returns with an error code of MPI_ERR_IN_STATUS.

Rationale. The error field in status is not needed for calls that return only one status, such as MPI_WAIT, since that would only duplicate the information returned by the function itself. The current design avoids the additional overhead of setting it, in such cases. The field is needed for calls that return multiple statuses, since each request may have had a different failure. (*End of rationale.*)

The status argument also returns information on the length of the message received. However, this information is not directly available as a field of the status variable and a call to MPI_GET_COUNT is required to “decode” this information.

MPI_GET_COUNT(status, datatype, count)

IN	status	return status of receive operation (Status)
IN	datatype	datatype of each receive buffer entry (handle)
OUT	count	number of received entries (integer)

```
int MPI_Get_count(const MPI_Status *status, MPI_Datatype datatype,
                 int *count)
```

```

MPI_Get_count(status, datatype, count, ierror) BIND(C)
  TYPE(MPI_Status), INTENT(IN) :: status
  TYPE(MPI_Datatype), INTENT(IN) :: datatype
  INTEGER, INTENT(OUT) :: count
  INTEGER, OPTIONAL, INTENT(OUT) :: ierror

```

```

MPI_GET_COUNT(STATUS, DATATYPE, COUNT, IERROR)
  INTEGER STATUS(MPI_STATUS_SIZE), DATATYPE, COUNT, IERROR

```

```

{int MPI::Status::Get_count(const MPI::Datatype& datatype) const(binding
  deprecated, see Section 15.2) }

```

Returns the number of entries received. (Again, we count *entries*, each of type *datatype*, not *bytes*.) The *datatype* argument should match the argument provided by the receive call that set the status variable. **If the number of entries received exceeds the limits of the count parameter, then MPI_GET_COUNT sets the value of count to MPI_UNDEFINED.** [(We

1 shall later see, in Section 4.1.11, that `MPI_GET_COUNT` may return, in certain situations,
 2 the value `MPI_UNDEFINED`.)] There are other situations where the value of `count` can be set
 3 to `MPI_UNDEFINED`; see Section 4.1.11.

4
 5 *Rationale.* Some message-passing libraries use `INOUT count`, `tag` and
 6 `source` arguments, thus using them both to specify the selection criteria for incoming
 7 messages and return the actual envelope values of the received message. The use of a
 8 separate status argument prevents errors that are often attached with `INOUT` argument
 9 (e.g., using the `MPI_ANY_TAG` constant as the tag in a receive). Some libraries use
 10 calls that refer implicitly to the “last message received.” This is not thread safe.

11 The `datatype` argument is passed to `MPI_GET_COUNT` so as to improve performance.
 12 A message might be received without counting the number of elements it contains,
 13 and the count value is often not needed. Also, this allows the same function to be
 14 used after a call to `MPI_PROBE` or `MPI_IPROBE`. With a status from `MPI_PROBE`
 15 or `MPI_IPROBE`, the same datatypes are allowed as in a call to `MPI_RECV` to receive
 16 this message. (*End of rationale.*)

17
 18 The value returned as the `count` argument of `MPI_GET_COUNT` for a datatype of length
 19 zero where zero bytes have been transferred is zero. If the number of bytes transferred is
 20 greater than zero, `MPI_UNDEFINED` is returned.

21
 22 *Rationale.* Zero-length datatypes may be created in a number of cases. An important
 23 case is `MPI_TYPE_CREATE_DARRAY`, where the definition of the particular darray
 24 results in an empty block on some MPI process. Programs written in an SPMD style
 25 will not check for this special case and may want to use `MPI_GET_COUNT` to check
 26 the status. (*End of rationale.*)

27
 28 *Advice to users.* The buffer size required for the receive can be affected by data con-
 29 versions and by the stride of the receive datatype. In most cases, the safest approach
 30 is to use the same datatype with `MPI_GET_COUNT` and the receive. (*End of advice*
 31 *to users.*)

32 All send and receive operations use the `buf`, `count`, `datatype`, `source`, `dest`, `tag`, `comm` and
 33 `status` arguments in the same way as the blocking `MPI_SEND` and `MPI_RECV` operations
 34 described in this section.

3.2.6 Passing `MPI_STATUS_IGNORE` for Status

35
 36
 37 Every call to `MPI_RECV` includes a `status` argument, wherein the system can return details
 38 about the message received. There are also a number of other MPI calls where `status`
 39 is returned. An object of type `MPI_STATUS` is not an MPI opaque object; its structure
 40 is declared in `mpi.h` and `mpif.h`, and it exists in the user’s program. In many cases,
 41 application programs are constructed so that it is unnecessary for them to examine the
 42 `status` fields. In these cases, it is a waste for the user to allocate a status object, and it is
 43 particularly wasteful for the MPI implementation to fill in fields in this object.

44 To cope with this problem, there are two predefined constants, `MPI_STATUS_IGNORE`
 45 and `MPI_STATUSES_IGNORE`, which when passed to a receive, `probe`, `wait`, or `test` function,
 46 inform the implementation that the status fields are not to be filled in. Note that
 47 `MPI_STATUS_IGNORE` is not a special type of `MPI_STATUS` object; rather, it is a special
 48

value for the argument. In C one would expect it to be NULL, not the address of a special MPI_STATUS.

MPI_STATUS_IGNORE, and the array version MPI_STATUSES_IGNORE, can be used everywhere a status argument is passed to a receive, wait, or test function. MPI_STATUS_IGNORE cannot be used when status is an IN argument. Note that in Fortran MPI_STATUS_IGNORE and MPI_STATUSES_IGNORE are objects like MPI_BOTTOM (not usable for initialization or assignment). See Section 2.5.4.

In general, this optimization can apply to all functions for which status or an array of statuses is an OUT argument. Note that this converts status into an INOUT argument. The functions that can be passed MPI_STATUS_IGNORE are all the various forms of MPI_RECV, MPI_PROBE, MPI_TEST, and MPI_WAIT, as well as MPI_REQUEST_GET_STATUS. When an array is passed, as in the MPI_{TEST|WAIT}{ALL|SOME} functions, a separate constant, MPI_STATUSES_IGNORE, is passed for the array argument. It is possible for an MPI function to return MPI_ERR_IN_STATUS even when MPI_STATUS_IGNORE or MPI_STATUSES_IGNORE has been passed to that function.

MPI_STATUS_IGNORE and MPI_STATUSES_IGNORE are not required to have the same values in C and Fortran.

It is not allowed to have some of the statuses in an array of statuses for MPI_{TEST|WAIT}{ALL|SOME} functions set to MPI_STATUS_IGNORE; one either specifies ignoring *all* of the statuses in such a call with MPI_STATUSES_IGNORE, or *none* of them by passing normal statuses in all positions in the array of statuses.

[In the deprecated C++ bindings, there] There are no C++ bindings for MPI_STATUS_IGNORE or MPI_STATUSES_IGNORE. To allow an OUT or INOUT MPI::Status argument to be ignored, all MPI C++ bindings that have OUT or INOUT MPI::Status parameters are overloaded with a second version that omits the OUT or INOUT MPI::Status parameter.

Example 3.1 The [deprecated] C++ bindings for MPI_PROBE are:

```
void MPI::Comm::Probe(int source, int tag, MPI::Status& status) const
void MPI::Comm::Probe(int source, int tag) const
```

3.3 Data Type Matching and Data Conversion

3.3.1 Type Matching Rules

One can think of message transfer as consisting of the following three phases.

1. Data is pulled out of the send buffer and a message is assembled.
2. A message is transferred from sender to receiver.
3. Data is pulled from the incoming message and disassembled into the receive buffer.

Type matching has to be observed at each of these three phases: The type of each variable in the sender buffer has to match the type specified for that entry by the send operation; the type specified by the send operation has to match the type specified by the receive operation; and the type of each variable in the receive buffer has to match the type specified for that entry by the receive operation. A program that fails to observe these three rules is erroneous.

1 To define type matching more precisely, we need to deal with two issues: matching of
 2 types of the host language with types specified in communication operations; and matching
 3 of types at sender and receiver.

4 The types of a send and receive match (phase two) if both operations use identical
 5 names. That is, MPI_INTEGER matches MPI_INTEGER, MPI_REAL matches MPI_REAL,
 6 and so on. There is one exception to this rule, discussed in Section 4.2, the type
 7 MPI_PACKED can match any other type.

8 The type of a variable in a host program matches the type specified in the commu-
 9 nication operation if the datatype name used by that operation corresponds to the basic
 10 type of the host program variable. For example, an entry with type name MPI_INTEGER
 11 matches a Fortran variable of type INTEGER. A table giving this correspondence for Fortran
 12 and C appears in Section 3.2.2. There are two exceptions to this last rule: an entry with
 13 type name MPI_BYTE or MPI_PACKED can be used to match any byte of storage (on a
 14 byte-addressable machine), irrespective of the datatype of the variable that contains this
 15 byte. The type MPI_PACKED is used to send data that has been explicitly packed, or
 16 receive data that will be explicitly unpacked, see Section 4.2. The type MPI_BYTE allows
 17 one to transfer the binary value of a byte in memory unchanged.

18 To summarize, the type matching rules fall into the three categories below.

- 19
- 20 • Communication of typed values (e.g., with datatype different from MPI_BYTE), where
 21 the datatypes of the corresponding entries in the sender program, in the send call, in
 22 the receive call and in the receiver program must all match.
- 23
- 24 • Communication of untyped values (e.g., of datatype MPI_BYTE), where both sender
 25 and receiver use the datatype MPI_BYTE. In this case, there are no requirements on
 26 the types of the corresponding entries in the sender and the receiver programs, nor is
 27 it required that they be the same.
- 28
- 29 • Communication involving packed data, where MPI_PACKED is used.

30 The following examples illustrate the first two cases.

31 **Example 3.2** Sender and receiver specify matching types.

```
32
33 CALL MPI_COMM_RANK(comm, rank, ierr)
34 IF (rank.EQ.0) THEN
35     CALL MPI_SEND(a(1), 10, MPI_REAL, 1, tag, comm, ierr)
36 ELSE IF (rank.EQ.1) THEN
37     CALL MPI_RECV(b(1), 15, MPI_REAL, 0, tag, comm, status, ierr)
38 END IF
39
```

40 This code is correct if both **a** and **b** are real arrays of size ≥ 10 . (In Fortran, it might
 41 be correct to use this code even if **a** or **b** have size < 10 : e.g., when **a(1)** can be equivalenced
 42 to an array with ten reals.)

43

44 **Example 3.3** Sender and receiver do not specify matching types.

45

46

47

48

```

CALL MPI_COMM_RANK(comm, rank, ierr)
IF (rank.EQ.0) THEN
    CALL MPI_SEND(a(1), 10, MPI_REAL, 1, tag, comm, ierr)
ELSE IF (rank.EQ.1) THEN
    CALL MPI_RECV(b(1), 40, MPI_BYTE, 0, tag, comm, status, ierr)
END IF

```

This code is erroneous, since sender and receiver do not provide matching datatype arguments.

Example 3.4 Sender and receiver specify communication of untyped values.

```

CALL MPI_COMM_RANK(comm, rank, ierr)
IF (rank.EQ.0) THEN
    CALL MPI_SEND(a(1), 40, MPI_BYTE, 1, tag, comm, ierr)
ELSE IF (rank.EQ.1) THEN
    CALL MPI_RECV(b(1), 60, MPI_BYTE, 0, tag, comm, status, ierr)
END IF

```

This code is correct, irrespective of the type and size of `a` and `b` (unless this results in an out of bound memory access).

Advice to users. If a buffer of type `MPI_BYTE` is passed as an argument to `MPI_SEND`, then MPI will send the data stored at contiguous locations, starting from the address indicated by the `buf` argument. This may have unexpected results when the data layout is not as a casual user would expect it to be. For example, some Fortran compilers implement variables of type `CHARACTER` as a structure that contains the character length and a pointer to the actual string. In such an environment, sending and receiving a Fortran `CHARACTER` variable using the `MPI_BYTE` type will not have the anticipated result of transferring the character string. For this reason, the user is advised to use typed communications whenever possible. (*End of advice to users.*)

Type `MPI_CHARACTER`

The type `MPI_CHARACTER` matches one character of a Fortran variable of type `CHARACTER`, rather than the entire character string stored in the variable. Fortran variables of type `CHARACTER` or substrings are transferred as if they were arrays of characters. This is illustrated in the example below.

Example 3.5

Transfer of Fortran `CHARACTER`s.

```

CHARACTER*10 a
CHARACTER*10 b

CALL MPI_COMM_RANK(comm, rank, ierr)
IF (rank.EQ.0) THEN
    CALL MPI_SEND(a, 5, MPI_CHARACTER, 1, tag, comm, ierr)
ELSE IF (rank.EQ.1) THEN
    CALL MPI_RECV(b(6:10), 5, MPI_CHARACTER, 0, tag, comm, status, ierr)
END IF

```

1 The last five characters of string `b` at process 1 are replaced by the first five characters
2 of string `a` at process 0.

3
4 *Rationale.* The alternative choice would be for `MPI_CHARACTER` to match a char-
5 acter of arbitrary length. This runs into problems.

6 A Fortran character variable is a constant length string, with no special termina-
7 tion symbol. There is no fixed convention on how to represent characters, and how
8 to store their length. Some compilers pass a character argument to a routine as a
9 pair of arguments, one holding the address of the string and the other holding the
10 length of string. Consider the case of an MPI communication call that is passed a
11 communication buffer with type defined by a derived datatype (Section 4.1). If this
12 communicator buffer contains variables of type `CHARACTER` then the information on
13 their length will not be passed to the MPI routine.

14 This problem forces us to provide explicit information on character length with the
15 MPI call. One could add a length parameter to the type `MPI_CHARACTER`, but this
16 does not add much convenience and the same functionality can be achieved by defining
17 a suitable derived datatype. (*End of rationale.*)

18
19 *Advice to implementors.* Some compilers pass Fortran `CHARACTER` arguments as a
20 structure with a length and a pointer to the actual string. In such an environment,
21 the MPI call needs to dereference the pointer in order to reach the string. (*End of*
22 *advice to implementors.*)

24 3.3.2 Data Conversion

25
26 One of the goals of MPI is to support parallel computations across heterogeneous environ-
27 nments. Communication in a heterogeneous environment may require data conversions. We
28 use the following terminology.

29 **type conversion** changes the datatype of a value, e.g., by rounding a `REAL` to an `INTEGER`.

30 **representation conversion** changes the binary representation of a value, e.g., from Hex
31 floating point to IEEE floating point.

32
33
34 The type matching rules imply that MPI communication never entails type conversion.
35 On the other hand, MPI requires that a representation conversion be performed when a
36 typed value is transferred across environments that use different representations for the
37 datatype of this value. MPI does not specify rules for representation conversion. Such
38 conversion is expected to preserve integer, logical or character values, and to convert a
39 floating point value to the nearest value that can be represented on the target system.

40 Overflow and underflow exceptions may occur during floating point conversions. Con-
41 version of integers or characters may also lead to exceptions when a value that can be
42 represented in one system cannot be represented in the other system. An exception occur-
43 ring during representation conversion results in a failure of the communication. An error
44 occurs either in the send operation, or the receive operation, or both.

45 If a value sent in a message is untyped (i.e., of type `MPI_BYTE`), then the binary
46 representation of the byte stored at the receiver is identical to the binary representation
47 of the byte loaded at the sender. This holds true, whether sender and receiver run in the
48 same or in distinct environments. No representation conversion is required. (Note that

representation conversion may occur when values of type `MPI_CHARACTER` or `MPI_CHAR` are transferred, for example, from an EBCDIC encoding to an ASCII encoding.)

No conversion need occur when an MPI program executes in a homogeneous system, where all processes run in the same environment.

Consider the three examples, 3.2–3.4. The first program is correct, assuming that `a` and `b` are `REAL` arrays of size ≥ 10 . If the sender and receiver execute in different environments, then the ten real values that are fetched from the send buffer will be converted to the representation for reals on the receiver site before they are stored in the receive buffer. While the number of real elements fetched from the send buffer equal the number of real elements stored in the receive buffer, the number of bytes stored need not equal the number of bytes loaded. For example, the sender may use a four byte representation and the receiver an eight byte representation for reals.

The second program is erroneous, and its behavior is undefined.

The third program is correct. The exact same sequence of forty bytes that were loaded from the send buffer will be stored in the receive buffer, even if sender and receiver run in a different environment. The message sent has exactly the same length (in bytes) and the same binary representation as the message received. If `a` and `b` are of different types, or if they are of the same type but different data representations are used, then the bits stored in the receive buffer may encode values that are different from the values they encoded in the send buffer.

Data representation conversion also applies to the envelope of a message: source, destination and tag are all integers that may need to be converted.

Advice to implementors. The current definition does not require messages to carry data type information. Both sender and receiver provide complete data type information. In a heterogeneous environment, one can either use a machine independent encoding such as XDR, or have the receiver convert from the sender representation to its own, or even have the sender do the conversion.

Additional type information might be added to messages in order to allow the system to detect mismatches between datatype at sender and receiver. This might be particularly useful in a slower but safer debug mode. (*End of advice to implementors.*)

MPI requires support for inter-language communication, i.e., if messages are sent by a C or C++ process and received by a Fortran process, or vice-versa. The behavior is defined in Section 16.3 on page 696.

3.4 Communication Modes

The send call described in Section 3.2.1 is **blocking**: it does not return until the message data and envelope have been safely stored away so that the sender is free to modify the send buffer. The message might be copied directly into the matching receive buffer, or it might be copied into a temporary system buffer.

Message buffering decouples the send and receive operations. A blocking send can complete as soon as the message was buffered, even if no matching receive has been executed by the receiver. On the other hand, message buffering can be expensive, as it entails additional memory-to-memory copying, and it requires the allocation of memory for buffering. MPI offers the choice of several communication modes that allow one to control the choice of the communication protocol.

1 The send call described in Section 3.2.1 uses the **standard** communication mode. In
2 this mode, it is up to MPI to decide whether outgoing messages will be buffered. MPI may
3 buffer outgoing messages. In such a case, the send call may complete before a matching
4 receive is invoked. On the other hand, buffer space may be unavailable, or MPI may choose
5 not to buffer outgoing messages, for performance reasons. In this case, the send call will
6 not complete until a matching receive has been posted, and the data has been moved to the
7 receiver.

8 Thus, a send in standard mode can be started whether or not a matching receive has
9 been posted. It may complete before a matching receive is posted. The standard mode send
10 is **non-local**: successful completion of the send operation may depend on the occurrence
11 of a matching receive.

12
13 *Rationale.* The reluctance of MPI to mandate whether standard sends are buffering
14 or not stems from the desire to achieve portable programs. Since any system will run
15 out of buffer resources as message sizes are increased, and some implementations may
16 want to provide little buffering, MPI takes the position that correct (and therefore,
17 portable) programs do not rely on system buffering in standard mode. Buffering may
18 improve the performance of a correct program, but it doesn't affect the result of the
19 program. If the user wishes to guarantee a certain amount of buffering, the user-
20 provided buffer system of Section 3.6 should be used, along with the buffered-mode
21 send. (*End of rationale.*)

22
23 There are three additional communication modes.

24 A **buffered** mode send operation can be started whether or not a matching receive
25 has been posted. It may complete before a matching receive is posted. However, unlike
26 the standard send, this operation is **local**, and its completion does not depend on the
27 occurrence of a matching receive. Thus, if a send is executed and no matching receive is
28 posted, then MPI must buffer the outgoing message, so as to allow the send call to complete.
29 An error will occur if there is insufficient buffer space. The amount of available buffer space
30 is controlled by the user — see Section 3.6. Buffer allocation by the user may be required
31 for the buffered mode to be effective.

32 A send that uses the **synchronous** mode can be started whether or not a matching
33 receive was posted. However, the send will complete successfully only if a matching receive is
34 posted, and the receive operation has started to receive the message sent by the synchronous
35 send. Thus, the completion of a synchronous send not only indicates that the send buffer
36 can be reused, but it also indicates that the receiver has reached a certain point in its
37 execution, namely that it has started executing the matching receive. If both sends and
38 receives are blocking operations then the use of the synchronous mode provides synchronous
39 communication semantics: a communication does not complete at either end before both
40 processes rendezvous at the communication. A send executed in this mode is **non-local**.

41 A send that uses the **ready** communication mode may be started *only* if the matching
42 receive is already posted. Otherwise, the operation is erroneous and its outcome is unde-
43 fined. On some systems, this allows the removal of a hand-shake operation that is otherwise
44 required and results in improved performance. The completion of the send operation does
45 not depend on the status of a matching receive, and merely indicates that the send buffer
46 can be reused. A send operation that uses the ready mode has the same semantics as a
47 standard send operation, or a synchronous send operation; it is merely that the sender
48 provides additional information to the system (namely that a matching receive is already

posted), that can save some overhead. In a correct program, therefore, a ready send could be replaced by a standard send with no effect on the behavior of the program other than performance.

Three additional send functions are provided for the three additional communication modes. The communication mode is indicated by a one letter prefix: B for buffered, S for synchronous, and R for ready.

MPI_BSEND (buf, count, datatype, dest, tag, comm)

IN	buf	initial address of send buffer (choice)
IN	count	number of elements in send buffer (non-negative integer)
IN	datatype	datatype of each send buffer element (handle)
IN	dest	rank of destination (integer)
IN	tag	message tag (integer)
IN	comm	communicator (handle)

```
int MPI_Bsend(const void* buf, int count, MPI_Datatype datatype, int dest,
             int tag, MPI_Comm comm)
```

```
MPI_Bsend(buf, count, datatype, dest, tag, comm, ierror) BIND(C)
    TYPE(*), DIMENSION(..), INTENT(IN) :: buf
    INTEGER, INTENT(IN) :: count, dest, tag
    TYPE(MPI_Datatype), INTENT(IN) :: datatype
    TYPE(MPI_Comm), INTENT(IN) :: comm
    INTEGER, OPTIONAL, INTENT(OUT) :: ierror
```

```
MPI_BSEND(BUF, COUNT, DATATYPE, DEST, TAG, COMM, IERROR)
    <type> BUF(*)
    INTEGER COUNT, DATATYPE, DEST, TAG, COMM, IERROR
```

```
{void MPI::Comm::Bsend(const void* buf, int count, const
    MPI::Datatype& datatype, int dest, int tag) const(binding
    deprecated, see Section 15.2) }
```

Send in buffered mode.

```

1 MPI_SSEND (buf, count, datatype, dest, tag, comm)
2     IN      buf                initial address of send buffer (choice)
3
4     IN      count              number of elements in send buffer (non-negative inte-
5                                ger)
6
7     IN      datatype           datatype of each send buffer element (handle)
8
9     IN      dest                rank of destination (integer)
10
11    IN      tag                  message tag (integer)
12
13    IN      comm                 communicator (handle)

```

```

ticket140. 12 int MPI_Ssend(const void* buf, int count, MPI_Datatype datatype, int dest,
13             int tag, MPI_Comm comm)

```

```

ticket-248T. 14 MPI_Ssend(buf, count, datatype, dest, tag, comm, ierror) BIND(C)
15             TYPE(*), DIMENSION(..), INTENT(IN) :: buf
16             INTEGER, INTENT(IN) :: count, dest, tag
17             TYPE(MPI_Datatype), INTENT(IN) :: datatype
18             TYPE(MPI_Comm), INTENT(IN) :: comm
19             INTEGER, OPTIONAL, INTENT(OUT) :: ierror

```

```

21 MPI_SSEND(BUF, COUNT, DATATYPE, DEST, TAG, COMM, IERROR)
22     <type> BUF(*)
23     INTEGER COUNT, DATATYPE, DEST, TAG, COMM, IERROR

```

```

25 {void MPI::Comm::Ssend(const void* buf, int count, const
26                       MPI::Datatype& datatype, int dest, int tag) const(binding
27                       deprecated, see Section 15.2) }

```

28 Send in synchronous mode.

```

31 MPI_RSEND (buf, count, datatype, dest, tag, comm)
32     IN      buf                initial address of send buffer (choice)
33
34     IN      count              number of elements in send buffer (non-negative inte-
35                                ger)
36
37     IN      datatype           datatype of each send buffer element (handle)
38
39     IN      dest                rank of destination (integer)
40
41    IN      tag                  message tag (integer)
42
43    IN      comm                 communicator (handle)

```

```

ticket140. 42 int MPI_Rsend(const void* buf, int count, MPI_Datatype datatype, int dest,
43             int tag, MPI_Comm comm)

```

```

ticket-248T. 44 MPI_Rsend(buf, count, datatype, dest, tag, comm, ierror) BIND(C)
45             TYPE(*), DIMENSION(..), INTENT(IN) :: buf
46             INTEGER, INTENT(IN) :: count, dest, tag
47             TYPE(MPI_Datatype), INTENT(IN) :: datatype
48

```

```

TYPE(MPI_Comm), INTENT(IN) :: comm
INTEGER, OPTIONAL, INTENT(OUT) :: ierror
MPI_RSEND(BUF, COUNT, DATATYPE, DEST, TAG, COMM, IERROR)
<type> BUF(*)
INTEGER COUNT, DATATYPE, DEST, TAG, COMM, IERROR
{void MPI::Comm::Rsend(const void* buf, int count, const
    MPI::Datatype& datatype, int dest, int tag) const(binding
    deprecated, see Section 15.2) }
```

Send in ready mode.

There is only one receive operation, but it matches any of the send modes. The receive operation described in the last section is **blocking**: it returns only after the receive buffer contains the newly received message. A receive can complete before the matching send has completed (of course, it can complete only after the matching send has started).

In a multi-threaded implementation of MPI, the system may de-schedule a thread that is blocked on a send or receive operation, and schedule another thread for execution in the same address space. In such a case it is the user's responsibility not to modify a communication buffer until the communication completes. Otherwise, the outcome of the computation is undefined.

Advice to implementors. Since a synchronous send cannot complete before a matching receive is posted, one will not normally buffer messages sent by such an operation.

It is recommended to choose buffering over blocking the sender, whenever possible, for standard sends. The programmer can signal his or her preference for blocking the sender until a matching receive occurs by using the synchronous send mode.

A possible communication protocol for the various communication modes is outlined below.

ready send: The message is sent as soon as possible.

synchronous send: The sender sends a request-to-send message. The receiver stores this request. When a matching receive is posted, the receiver sends back a permission-to-send message, and the sender now sends the message.

standard send: First protocol may be used for short messages, and second protocol for long messages.

buffered send: The sender copies the message into a buffer and then sends it with a nonblocking send (using the same protocol as for standard send).

Additional control messages might be needed for flow control and error recovery. Of course, there are many other possible protocols.

Ready send can be implemented as a standard send. In this case there will be no performance advantage (or disadvantage) for the use of ready send.

A standard send can be implemented as a synchronous send. In such a case, no data buffering is needed. However, users may expect some buffering.

In a multi-threaded environment, the execution of a blocking communication should block only the executing thread, allowing the thread scheduler to de-schedule this thread and schedule another thread for execution. (*End of advice to implementors.*)

3.5 Semantics of Point-to-Point Communication

A valid MPI implementation guarantees certain general properties of point-to-point communication, which are described in this section.

Order Messages are *non-overtaking*: If a sender sends two messages in succession to the same destination, and both match the same receive, then this operation cannot receive the second message if the first one is still pending. If a receiver posts two receives in succession, and both match the same message, then the second receive operation cannot be satisfied by this message, if the first one is still pending. This requirement facilitates matching of sends to receives. It guarantees that message-passing code is deterministic, if processes are single-threaded and the wildcard `MPI_ANY_SOURCE` is not used in receives. (Some of the calls described later, such as `MPI_CANCEL` or `MPI_WAITANY`, are additional sources of nondeterminism.)

If a process has a single thread of execution, then any two communications executed by this process are ordered. On the other hand, if the process is multi-threaded, then the semantics of thread execution may not define a relative order between two send operations executed by two distinct threads. The operations are logically concurrent, even if one physically precedes the other. In such a case, the two messages sent can be received in any order. Similarly, if two receive operations that are logically concurrent receive two successively sent messages, then the two messages can match the two receives in either order.

Example 3.6 An example of non-overtaking messages.

```
CALL MPI_COMM_RANK(comm, rank, ierr)
IF (rank.EQ.0) THEN
    CALL MPI_BSEND(buf1, count, MPI_REAL, 1, tag, comm, ierr)
    CALL MPI_BSEND(buf2, count, MPI_REAL, 1, tag, comm, ierr)
ELSE IF (rank.EQ.1) THEN
    CALL MPI_RECV(buf1, count, MPI_REAL, 0, MPI_ANY_TAG, comm, status, ierr)
    CALL MPI_RECV(buf2, count, MPI_REAL, 0, tag, comm, status, ierr)
END IF
```

The message sent by the first send must be received by the first receive, and the message sent by the second send must be received by the second receive.

Progress If a pair of matching send and receives have been initiated on two processes, then at least one of these two operations will complete, independently of other actions in the system: the send operation will complete, unless the receive is satisfied by another message, and completes; the receive operation will complete, unless the message sent is consumed by another matching receive that was posted at the same destination process.

Example 3.7 An example of two, intertwined matching pairs.

```

CALL MPI_COMM_RANK(comm, rank, ierr) 1
IF (rank.EQ.0) THEN 2
    CALL MPI_BSEND(buf1, count, MPI_REAL, 1, tag1, comm, ierr) 3
    CALL MPI_SSEND(buf2, count, MPI_REAL, 1, tag2, comm, ierr) 4
ELSE IF (rank.EQ.1) THEN 5
    CALL MPI_RECV(buf1, count, MPI_REAL, 0, tag2, comm, status, ierr) 6
    CALL MPI_RECV(buf2, count, MPI_REAL, 0, tag1, comm, status, ierr) 7
END IF 8

```

Both processes invoke their first communication call. Since the first send of process zero uses the buffered mode, it must complete, irrespective of the state of process one. Since no matching receive is posted, the message will be copied into buffer space. (If insufficient buffer space is available, then the program will fail.) The second send is then invoked. At that point, a matching pair of send and receive operation is enabled, and both operations must complete. Process one next invokes its second receive call, which will be satisfied by the buffered message. Note that process one received the messages in the reverse order they were sent.

Fairness MPI makes no guarantee of *fairness* in the handling of communication. Suppose that a send is posted. Then it is possible that the destination process repeatedly posts a receive that matches this send, yet the message is never received, because it is each time overtaken by another message, sent from another source. Similarly, suppose that a receive was posted by a multi-threaded process. Then it is possible that messages that match this receive are repeatedly received, yet the receive is never satisfied, because it is overtaken by other receives posted at this node (by other executing threads). It is the programmer's responsibility to prevent starvation in such situations.

Resource limitations Any pending communication operation consumes system resources that are limited. Errors may occur when lack of resources prevent the execution of an MPI call. A quality implementation will use a (small) fixed amount of resources for each pending send in the ready or synchronous mode and for each pending receive. However, buffer space may be consumed to store messages sent in standard mode, and must be consumed to store messages sent in buffered mode, when no matching receive is available. The amount of space available for buffering will be much smaller than program data memory on many systems. Then, it will be easy to write programs that overrun available buffer space.

MPI allows the user to provide buffer memory for messages sent in the buffered mode. Furthermore, MPI specifies a detailed operational model for the use of this buffer. An MPI implementation is required to do no worse than implied by this model. This allows users to avoid buffer overflows when they use buffered sends. Buffer allocation and use is described in Section 3.6.

A buffered send operation that cannot complete because of a lack of buffer space is erroneous. When such a situation is detected, an error is signalled that may cause the program to terminate abnormally. On the other hand, a standard send operation that cannot complete because of lack of buffer space will merely block, waiting for buffer space to become available or for a matching receive to be posted. This behavior is preferable in many situations. Consider a situation where a producer repeatedly produces new values and sends them to a consumer. Assume that the producer produces new values faster than the consumer can consume them. If buffered sends are used, then a buffer overflow

will result. Additional synchronization has to be added to the program so as to prevent this from occurring. If standard sends are used, then the producer will be automatically throttled, as its send operations will block when buffer space is unavailable.

In some situations, a lack of buffer space leads to deadlock situations. This is illustrated by the examples below.

Example 3.8 An exchange of messages.

```

CALL MPI_COMM_RANK(comm, rank, ierr)
IF (rank.EQ.0) THEN
    CALL MPI_SEND(sendbuf, count, MPI_REAL, 1, tag, comm, ierr)
    CALL MPI_RECV(recvbuf, count, MPI_REAL, 1, tag, comm, status, ierr)
ELSE IF (rank.EQ.1) THEN
    CALL MPI_RECV(recvbuf, count, MPI_REAL, 0, tag, comm, status, ierr)
    CALL MPI_SEND(sendbuf, count, MPI_REAL, 0, tag, comm, ierr)
END IF

```

This program will succeed even if no buffer space for data is available. The standard send operation can be replaced, in this example, with a synchronous send.

Example 3.9 An errant attempt to exchange messages.

```

CALL MPI_COMM_RANK(comm, rank, ierr)
IF (rank.EQ.0) THEN
    CALL MPI_RECV(recvbuf, count, MPI_REAL, 1, tag, comm, status, ierr)
    CALL MPI_SEND(sendbuf, count, MPI_REAL, 1, tag, comm, ierr)
ELSE IF (rank.EQ.1) THEN
    CALL MPI_RECV(recvbuf, count, MPI_REAL, 0, tag, comm, status, ierr)
    CALL MPI_SEND(sendbuf, count, MPI_REAL, 0, tag, comm, ierr)
END IF

```

The receive operation of the first process must complete before its send, and can complete only if the matching send of the second processor is executed. The receive operation of the second process must complete before its send and can complete only if the matching send of the first process is executed. This program will always deadlock. The same holds for any other send mode.

Example 3.10 An exchange that relies on buffering.

```

CALL MPI_COMM_RANK(comm, rank, ierr)
IF (rank.EQ.0) THEN
    CALL MPI_SEND(sendbuf, count, MPI_REAL, 1, tag, comm, ierr)
    CALL MPI_RECV(recvbuf, count, MPI_REAL, 1, tag, comm, status, ierr)
ELSE IF (rank.EQ.1) THEN
    CALL MPI_SEND(sendbuf, count, MPI_REAL, 0, tag, comm, ierr)
    CALL MPI_RECV(recvbuf, count, MPI_REAL, 0, tag, comm, status, ierr)
END IF

```

The message sent by each process has to be copied out before the send operation returns and the receive operation starts. For the program to complete, it is necessary that at least one of the two messages sent be buffered. Thus, this program can succeed only if the communication system can buffer at least count words of data.

Advice to users. When standard send operations are used, then a deadlock situation may occur where both processes are blocked because buffer space is not available. The same will certainly happen, if the synchronous mode is used. If the buffered mode is used, and not enough buffer space is available, then the program will not complete either. However, rather than a deadlock situation, we shall have a buffer overflow error.

A program is “safe” if no message buffering is required for the program to complete. One can replace all sends in such program with synchronous sends, and the program will still run correctly. This conservative programming style provides the best portability, since program completion does not depend on the amount of buffer space available or on the communication protocol used.

Many programmers prefer to have more leeway and opt to use the “unsafe” programming style shown in Example 3.10. In such cases, the use of standard sends is likely to provide the best compromise between performance and robustness: quality implementations will provide sufficient buffering so that “common practice” programs will not deadlock. The buffered send mode can be used for programs that require more buffering, or in situations where the programmer wants more control. This mode might also be used for debugging purposes, as buffer overflow conditions are easier to diagnose than deadlock conditions.

Nonblocking message-passing operations, as described in Section 3.7, can be used to avoid the need for buffering outgoing messages. This prevents deadlocks due to lack of buffer space, and improves performance, by allowing overlap of computation and communication, and avoiding the overheads of allocating buffers and copying messages into buffers. (*End of advice to users.*)

3.6 Buffer Allocation and Usage

A user may specify a buffer to be used for buffering messages sent in buffered mode. Buffering is done by the sender.

```
MPI_BUFFER_ATTACH(buffer, size)
```

IN	buffer	initial buffer address (choice)
IN	size	buffer size, in bytes (non-negative integer)

```
int MPI_Buffer_attach(void* buffer, int size)
```

```
MPI_Buffer_attach(buffer, size, ierror) BIND(C)
    TYPE(*), DIMENSION(..), ASYNCHRONOUS :: buffer
    INTEGER, INTENT(IN) :: size
    INTEGER, OPTIONAL, INTENT(OUT) :: ierror
```

```
MPI_BUFFER_ATTACH(BUFFER, SIZE, IERROR)
```

```
<type> BUFFER(*)
INTEGER SIZE, IERROR
```

ticket-248T.

```

1 {void MPI::Attach_buffer(void* buffer, int size) (binding deprecated, see
2     Section 15.2) }
```

Provides to MPI a buffer in the user's memory to be used for buffering outgoing messages. The buffer is used only by messages sent in buffered mode. Only one buffer can be attached to a process at a time. In C and C++, `buffer` is the starting address of a memory region. In Fortran, one can pass the first element of a memory region or a whole array, which must be 'simply contiguous' (for 'simply contiguous', see also Section 16.2.12 on page 675).

```

11 MPI_BUFFER_DETACH(buffer_addr, size)
```

```

12     OUT     buffer_addr           initial buffer address (choice)
13
14     OUT     size                 buffer size, in bytes (non-negative integer)
```

```

16 int MPI_Buffer_detach(void* buffer_addr, int* size)
```

```

17 MPI_Buffer_detach(buffer_addr, size, ierror) BIND(C)
18     USE, INTRINSIC :: ISO_C_BINDING, ONLY : C_PTR
19     TYPE(C_PTR), INTENT(OUT) :: buffer_addr
20     INTEGER, INTENT(OUT) :: size
21     INTEGER, OPTIONAL, INTENT(OUT) :: ierror
```

```

23 MPI_BUFFER_DETACH(BUFFER_ADDR, SIZE, IERROR)
```

```

24     <type> BUFFER_ADDR(*)
25     INTEGER SIZE, IERROR
```

```

27 {int MPI::Detach_buffer(void*& buffer) (binding deprecated, see Section 15.2) }
```

Detach the buffer currently associated with MPI. The call returns the address and the size of the detached buffer. This operation will block until all messages currently in the buffer have been transmitted. Upon return of this function, the user may reuse or deallocate the space taken by the buffer.

Example 3.11 Calls to attach and detach buffers.

```

34 #define BUFFSIZE 10000
35 int size;
36 char *buff;
37 MPI_Buffer_attach( malloc(BUFFSIZE), BUFFSIZE);
38 /* a buffer of 10000 bytes can now be used by MPI_Bsend */
39 MPI_Buffer_detach( &buff, &size);
40 /* Buffer size reduced to zero */
41 MPI_Buffer_attach( buff, size);
42 /* Buffer of 10000 bytes available again */
```

Advice to users. Even though the C functions `MPI_Buffer_attach` and `MPI_Buffer_detach` both have a first argument of type `void*`, these arguments are used differently: A pointer to the buffer is passed to `MPI_Buffer_attach`; the address of the pointer is passed to `MPI_Buffer_detach`, so that this call can return the pointer value.

ticket229.2.

In Fortran with the `mpi` module or `mpif.h`, the type of the `buffer_addr` argument is wrongly defined and the argument is therefore unused. In Fortran with the `mpi_f08` module, the address of the buffer is returned as `TYPE(C_PTR)`, see also Example 8.1 on page 357 about the use of `C_PTR` pointers. (*End of advice to users.*)

Rationale. Both arguments are defined to be of type `void*` (rather than `void*` and `void**`, respectively), so as to avoid complex type casts. E.g., in the last example, `&buff`, which is of type `char**`, can be passed as argument to `MPI_Buffer_detach` without type casting. If the formal parameter had type `void**` then we would need a type cast before and after the call. (*End of rationale.*)

The statements made in this section describe the behavior of MPI for buffered-mode sends. When no buffer is currently associated, MPI behaves as if a zero-sized buffer is associated with the process.

MPI must provide as much buffering for outgoing messages *as if* outgoing message data were buffered by the sending process, in the specified buffer space, using a circular, contiguous-space allocation policy. We outline below a model implementation that defines this policy. MPI may provide more buffering, and may use a better buffer allocation algorithm than described below. On the other hand, MPI may signal an error whenever the simple buffering allocator described below would run out of space. In particular, if no buffer is explicitly associated with the process, then any buffered send may cause an error.

MPI does not provide mechanisms for querying or controlling buffering done by standard mode sends. It is expected that vendors will provide such information for their implementations.

Rationale. There is a wide spectrum of possible implementations of buffered communication: buffering can be done at sender, at receiver, or both; buffers can be dedicated to one sender-receiver pair, or be shared by all communications; buffering can be done in real or in virtual memory; it can use dedicated memory, or memory shared by other processes; buffer space may be allocated statically or be changed dynamically; etc. It does not seem feasible to provide a portable mechanism for querying or controlling buffering that would be compatible with all these choices, yet provide meaningful information. (*End of rationale.*)

3.6.1 Model Implementation of Buffered Mode

The model implementation uses the packing and unpacking functions described in Section 4.2 and the nonblocking communication functions described in Section 3.7.

We assume that a circular queue of pending message entries (PME) is maintained. Each entry contains a communication request handle that identifies a pending nonblocking send, a pointer to the next entry and the packed message data. The entries are stored in successive locations in the buffer. Free space is available between the queue tail and the queue head.

A buffered send call results in the execution of the following code.

- Traverse sequentially the PME queue from head towards the tail, deleting all entries for communications that have completed, up to the first entry with an uncompleted request; update queue head to point to that entry.

- 1 • Compute the number, n , of bytes needed to store an entry for the new message. An upper bound on n can be computed as follows: A call to the function
- 2 `MPI_PACK_SIZE(count, datatype, comm, size)`, with the `count`, `datatype` and `comm`
- 3 arguments used in the `MPI_BSEND` call, returns an upper bound on the amount
- 4 of space needed to buffer the message data (see Section 4.2). The MPI constant
- 5 `MPI_BSEND_OVERHEAD` provides an upper bound on the additional space consumed
- 6 by the entry (e.g., for pointers or envelope information).
- 7
- 8
- 9 • Find the next contiguous empty space of n bytes in buffer (space following queue tail,
- 10 or space at start of buffer if queue tail is too close to end of buffer). If space is not
- 11 found then raise buffer overflow error.
- 12
- 13 • Append to end of PME queue in contiguous space the new entry that contains request
- 14 handle, next pointer and packed message data; `MPI_PACK` is used to pack data.
- 15
- 16 • Post nonblocking send (standard mode) for packed data.
- 17
- 18 • Return

19 3.7 Nonblocking Communication

20
21 One can improve performance on many systems by overlapping communication and com-
22 putation. This is especially true on systems where communication can be executed au-
23 tonomously by an intelligent communication controller. Light-weight threads are one mech-
24 anism for achieving such overlap. An alternative mechanism that often leads to better
25 performance is to use **nonblocking communication**. A nonblocking **send start** call ini-
26 tiates the send operation, but does not complete it. The send start call can return before
27 the message was copied out of the send buffer. A separate **send complete** call is needed
28 to complete the communication, i.e., to verify that the data has been copied out of the send
29 buffer. With suitable hardware, the transfer of data out of the sender memory may proceed
30 concurrently with computations done at the sender after the send was initiated and before it
31 completed. Similarly, a nonblocking **receive start call** initiates the receive operation, but
32 does not complete it. The call can return before a message is stored into the receive buffer.
33 A separate **receive complete** call is needed to complete the receive operation and verify
34 that the data has been received into the receive buffer. With suitable hardware, the transfer
35 of data into the receiver memory may proceed concurrently with computations done after
36 the receive was initiated and before it completed. The use of nonblocking receives may also
37 avoid system buffering and memory-to-memory copying, as information is provided early
38 on the location of the receive buffer.

39 Nonblocking send start calls can use the same four modes as blocking sends: **standard**,
40 **buffered**, **synchronous** and **ready**. These carry the same meaning. Sends of all modes, **ready**
41 excepted, can be started whether a matching receive has been posted or not; a nonblocking
42 **ready** send can be started only if a matching receive is posted. In all cases, the send start call
43 is local: it returns immediately, irrespective of the status of other processes. If the call causes
44 some system resource to be exhausted, then it will fail and return an error code. Quality
45 implementations of MPI should ensure that this happens only in “pathological” cases. That
46 is, an MPI implementation should be able to support a large number of pending nonblocking
47 operations.

The send-complete call returns when data has been copied out of the send buffer. It may carry additional meaning, depending on the send mode.

If the send mode is *synchronous*, then the send can complete only if a matching receive has started. That is, a receive has been posted, and has been matched with the send. In this case, the send-complete call is non-local. Note that a synchronous, nonblocking send may complete, if matched by a nonblocking receive, before the receive complete call occurs. (It can complete as soon as the sender “knows” the transfer will complete, but before the receiver “knows” the transfer will complete.)

If the send mode is *buffered* then the message must be buffered if there is no pending receive. In this case, the send-complete call is local, and must succeed irrespective of the status of a matching receive.

If the send mode is *standard* then the send-complete call may return before a matching receive is posted, if the message is buffered. On the other hand, the send-complete may not complete until a matching receive is posted, and the message was copied into the receive buffer.

Nonblocking sends can be matched with blocking receives, and vice-versa.

Advice to users. The completion of a send operation may be delayed, for standard mode, and must be delayed, for synchronous mode, until a matching receive is posted. The use of nonblocking sends in these two cases allows the sender to proceed ahead of the receiver, so that the computation is more tolerant of fluctuations in the speeds of the two processes.

Nonblocking sends in the buffered and ready modes have a more limited impact, e.g., the blocking version of buffered send is capable of completing regardless of when a matching receive call is made. However, separating the start from the completion of these sends still gives some opportunity for optimization within the MPI library. For example, starting a buffered send gives an implementation more flexibility in determining if and how the message is buffered. There are also advantages for both nonblocking buffered and ready modes when data copying can be done concurrently with computation.

The message-passing model implies that communication is initiated by the sender. The communication will generally have lower overhead if a receive is already posted when the sender initiates the communication (data can be moved directly to the receive buffer, and there is no need to queue a pending send request). However, a receive operation can complete only after the matching send has occurred. The use of nonblocking receives allows one to achieve lower communication overheads without blocking the receiver while it waits for the send. (*End of advice to users.*)

3.7.1 Communication Request Objects

Nonblocking communications use opaque *request* objects to identify communication operations and match the operation that initiates the communication with the operation that terminates it. These are system objects that are accessed via a handle. A request object identifies various properties of a communication operation, such as the send mode, the communication buffer that is associated with it, its context, the tag and destination arguments to be used for a send, or the tag and source arguments to be used for a receive. In addition, this object stores information about the status of the pending communication operation.

3.7.2 Communication Initiation

We use the same naming conventions as for blocking communication: a prefix of B, S, or R is used for buffered, synchronous or ready mode. In addition a prefix of I (for immediate) indicates that the call is nonblocking.

```
MPI_ISEND(buf, count, datatype, dest, tag, comm, request)
```

IN	buf	initial address of send buffer (choice)
IN	count	number of elements in send buffer (non-negative integer)
IN	datatype	datatype of each send buffer element (handle)
IN	dest	rank of destination (integer)
IN	tag	message tag (integer)
IN	comm	communicator (handle)
OUT	request	communication request (handle)

```
int MPI_Isend(const void* buf, int count, MPI_Datatype datatype, int dest,
             int tag, MPI_Comm comm, MPI_Request *request)
```

```
MPI_Isend(buf, count, datatype, dest, tag, comm, request, ierror) BIND(C)
    TYPE(*), DIMENSION(..), INTENT(IN), ASYNCHRONOUS :: buf
    INTEGER, INTENT(IN) :: count, dest, tag
    TYPE(MPI_Datatype), INTENT(IN) :: datatype
    TYPE(MPI_Comm), INTENT(IN) :: comm
    TYPE(MPI_Request), INTENT(OUT) :: request
    INTEGER, OPTIONAL, INTENT(OUT) :: ierror
```

```
MPI_ISEND(BUF, COUNT, DATATYPE, DEST, TAG, COMM, REQUEST, IERROR)
    <type> BUF(*)
    INTEGER COUNT, DATATYPE, DEST, TAG, COMM, REQUEST, IERROR
```

```
{MPI::Request MPI::Comm::Isend(const void* buf, int count, const
    MPI::Datatype& datatype, int dest, int tag) const(binding
    deprecated, see Section 15.2) }
```

Start a standard mode, nonblocking send.

```

MPI_IBSEND(buf, count, datatype, dest, tag, comm, request) 1
    IN      buf      initial address of send buffer (choice) 2
    IN      count    number of elements in send buffer (non-negative inte- 3
                    ger) 4
    IN      datatype datatype of each send buffer element (handle) 5
    IN      dest     rank of destination (integer) 6
    IN      tag      message tag (integer) 7
    IN      comm     communicator (handle) 8
    OUT     request  communication request (handle) 9
                                                    10
                                                    11
                                                    12
                                                    13
int MPI_Ibsend(const void* buf, int count, MPI_Datatype datatype, int dest, 14 ticket140.
               int tag, MPI_Comm comm, MPI_Request *request) 15 ticket-248T.
MPI_Ibsend(buf, count, datatype, dest, tag, comm, request, ierror) BIND(C) 16
    TYPE(*), DIMENSION(..), INTENT(IN), ASYNCHRONOUS :: buf 17
    INTEGER, INTENT(IN) :: count, dest, tag 18
    TYPE(MPI_Datatype), INTENT(IN) :: datatype 19
    TYPE(MPI_Comm), INTENT(IN) :: comm 20
    TYPE(MPI_Request), INTENT(OUT) :: request 21
    INTEGER, OPTIONAL, INTENT(OUT) :: ierror 22
                                                    23
MPI_IBSEND(BUF, COUNT, DATATYPE, DEST, TAG, COMM, REQUEST, IERROR) 24
    <type> BUF(*) 25
    INTEGER COUNT, DATATYPE, DEST, TAG, COMM, REQUEST, IERROR 26
{MPI::Request MPI::Comm::Ibsend(const void* buf, int count, const 27
    MPI::Datatype& datatype, int dest, int tag) const(binding 28
    deprecated, see Section 15.2) } 29
                                                    30
    Start a buffered mode, nonblocking send. 31
                                                    32
MPI_ISSEND(buf, count, datatype, dest, tag, comm, request) 33
    IN      buf      initial address of send buffer (choice) 34
    IN      count    number of elements in send buffer (non-negative inte- 35
                    ger) 36
    IN      datatype datatype of each send buffer element (handle) 37
    IN      dest     rank of destination (integer) 38
    IN      tag      message tag (integer) 39
    IN      comm     communicator (handle) 40
    OUT     request  communication request (handle) 41
                                                    42
                                                    43
                                                    44
                                                    45
int MPI_Issend(const void* buf, int count, MPI_Datatype datatype, int dest, 46 ticket140.
               int tag, MPI_Comm comm, MPI_Request *request) 47
                                                    48 ticket-248T.

```

```

1 MPI_Issend(buf, count, datatype, dest, tag, comm, request, ierror) BIND(C)
2   TYPE(*), DIMENSION(..), INTENT(IN), ASYNCHRONOUS :: buf
3   INTEGER, INTENT(IN) :: count, dest, tag
4   TYPE(MPI_Datatype), INTENT(IN) :: datatype
5   TYPE(MPI_Comm), INTENT(IN) :: comm
6   TYPE(MPI_Request), INTENT(OUT) :: request
7   INTEGER, OPTIONAL, INTENT(OUT) :: ierror

```

```

8 MPI_ISSEND(BUF, COUNT, DATATYPE, DEST, TAG, COMM, REQUEST, IERROR)
9   <type> BUF(*)
10  INTEGER COUNT, DATATYPE, DEST, TAG, COMM, REQUEST, IERROR

```

```

12 {MPI::Request MPI::Comm::Issend(const void* buf, int count, const
13     MPI::Datatype& datatype, int dest, int tag) const(binding
14     deprecated, see Section 15.2)}

```

15 Start a synchronous mode, nonblocking send.

```

17
18 MPI_IRSEND(buf, count, datatype, dest, tag, comm, request)
19
20 IN      buf                initial address of send buffer (choice)
21 IN      count              number of elements in send buffer (non-negative inte-
22                                ger)
23 IN      datatype           datatype of each send buffer element (handle)
24 IN      dest                rank of destination (integer)
25 IN      tag                 message tag (integer)
26 IN      comm                communicator (handle)
27 IN      request             communication request (handle)
28
29 OUT     request

```

ticket140. 31 int MPI_Irsend(const void* buf, int count, MPI_Datatype datatype, int dest,
ticket-248T. 32 int tag, MPI_Comm comm, MPI_Request *request)

```

33 MPI_Irsend(buf, count, datatype, dest, tag, comm, request, ierror) BIND(C)
34   TYPE(*), DIMENSION(..), INTENT(IN), ASYNCHRONOUS :: buf
35   INTEGER, INTENT(IN) :: count, dest, tag
36   TYPE(MPI_Datatype), INTENT(IN) :: datatype
37   TYPE(MPI_Comm), INTENT(IN) :: comm
38   TYPE(MPI_Request), INTENT(OUT) :: request
39   INTEGER, OPTIONAL, INTENT(OUT) :: ierror

```

```

41 MPI_IRSEND(BUF, COUNT, DATATYPE, DEST, TAG, COMM, REQUEST, IERROR)
42   <type> BUF(*)
43   INTEGER COUNT, DATATYPE, DEST, TAG, COMM, REQUEST, IERROR

```

```

44 {MPI::Request MPI::Comm::Irsend(const void* buf, int count, const
45     MPI::Datatype& datatype, int dest, int tag) const(binding
46     deprecated, see Section 15.2)}

```

47 Start a ready mode nonblocking send.

MPI_Irecv (buf, count, datatype, source, tag, comm, request)			1
OUT	buf	initial address of receive buffer (choice)	2
IN	count	number of elements in receive buffer (non-negative integer)	3
			4
			5
IN	datatype	datatype of each receive buffer element (handle)	6
IN	source	rank of source or MPI_ANY_SOURCE (integer)	7
IN	tag	message tag or MPI_ANY_TAG (integer)	8
IN	comm	communicator (handle)	9
OUT	request	communication request (handle)	10
			11
			12

```
int MPI_Irecv(void* buf, int count, MPI_Datatype datatype, int source,
             int tag, MPI_Comm comm, MPI_Request *request)
```

```
MPI_Irecv(buf, count, datatype, source, tag, comm, request, ierror) BIND(C)
    TYPE(*), DIMENSION(..), ASYNCHRONOUS :: buf
    INTEGER, INTENT(IN) :: count, source, tag
    TYPE(MPI_Datatype), INTENT(IN) :: datatype
    TYPE(MPI_Comm), INTENT(IN) :: comm
    TYPE(MPI_Request), INTENT(OUT) :: request
    INTEGER, OPTIONAL, INTENT(OUT) :: ierror
```

```
MPI_Irecv(BUF, COUNT, DATATYPE, SOURCE, TAG, COMM, REQUEST, IERROR)
    <type> BUF(*)
    INTEGER COUNT, DATATYPE, SOURCE, TAG, COMM, REQUEST, IERROR
```

```
{MPI::Request MPI::Comm::Irecv(void* buf, int count, const
    MPI::Datatype& datatype, int source, int tag) const(binding
    deprecated, see Section 15.2) }
```

Start a nonblocking receive.

These calls allocate a communication request object and associate it with the request handle (the argument request). The request can be used later to query the status of the communication or wait for its completion.

A nonblocking send call indicates that the system may start copying data out of the send buffer. The sender should not modify any part of the send buffer after a nonblocking send operation is called, until the send completes.

A nonblocking receive call indicates that the system may start writing data into the receive buffer. The receiver should not access any part of the receive buffer after a nonblocking receive operation is called, until the receive completes.

Advice to users. To prevent problems with the argument copying and register optimization done by Fortran compilers, please note the hints in [subsections “Problems Due to Data Copying and Sequence Association,” and “A Problem with Register Optimization” in Section 16.2.10 on pages 675 and 681.]Sections 16.2.10-16.2.20, especially in Sections 16.2.12 and 16.2.13 on pages 675-678 about “Problems Due to Data Copying and Sequence Association with Subscript Triplets” and “Vector Subscripts”, and in Sections 16.2.16 to 16.2.19 on pages 681 to 692 about “Optimization Problems”,

1 “Code Movements and Register Optimization”, “Temporary Data Movements” and “Per-
2 manent Data Movements”. (*End of advice to users.*)

3.7.3 Communication Completion

5 The functions `MPI_WAIT` and `MPI_TEST` are used to complete a nonblocking communica-
6 tion. The completion of a send operation indicates that the sender is now free to update the
7 locations in the send buffer (the send operation itself leaves the content of the send buffer
8 unchanged). It does not indicate that the message has been received, rather, it may have
9 been buffered by the communication subsystem. However, if a `synchronous` mode send was
10 used, the completion of the send operation indicates that a matching receive was initiated,
11 and that the message will eventually be received by this matching receive.
12

13 The completion of a receive operation indicates that the receive buffer contains the
14 received message, the receiver is now free to access it, and that the status object is set. It
15 does not indicate that the matching send operation has completed (but indicates, of course,
16 that the send was initiated).

17 We shall use the following terminology: A **null** handle is a handle with value
18 `MPI_REQUEST_NULL`. A persistent request and the handle to it are **inactive** if the re-
19 quest is not associated with any ongoing communication (see Section 3.9). A handle is
20 **active** if it is neither null nor inactive. An **empty** status is a status which is set to re-
21 turn `tag = MPI_ANY_TAG`, `source = MPI_ANY_SOURCE`, `error = MPI_SUCCESS`, and is also
22 internally configured so that calls to `MPI_GET_COUNT` [and], `MPI_GET_ELEMENTS`, and
23 `MPI_GET_ELEMENTS_X` return `count = 0` and `MPI_TEST_CANCELLED` returns false. We
24 set a status variable to empty when the value returned by it is not significant. Status is set
25 in this way so as to prevent errors due to accesses of stale information.

26 The fields in a status object returned by a call to `MPI_WAIT`, `MPI_TEST`, or any
27 of the other derived functions (`MPI_{TEST|WAIT}{ALL|SOME|ANY}`), where the request
28 corresponds to a send call, are undefined, with two exceptions: The error status field will
29 contain valid information if the wait or test call returned with `MPI_ERR_IN_STATUS`; and
30 the returned status can be queried by the call `MPI_TEST_CANCELLED`.

31 Error codes belonging to the error class `MPI_ERR_IN_STATUS` should be returned only
32 by the MPI completion functions that take arrays of `MPI_STATUS`. For the functions
33 `MPI_TEST`, `MPI_TESTANY`, `MPI_WAIT`, and `MPI_WAITANY`, which return a single
34 `MPI_STATUS` value, the normal MPI error return process should be used (not the
35 `MPI_ERROR` field in the `MPI_STATUS` argument).

37 `MPI_WAIT(request, status)`

39	INOUT	request	request (handle)
40	OUT	status	status object (Status)

42 `int MPI_Wait(MPI_Request *request, MPI_Status *status)`

44 `MPI_Wait(request, status, ierror) BIND(C)`
45 `TYPE(MPI_Request), INTENT(INOUT) :: request`
46 `TYPE(MPI_Status) :: status`
47 `INTEGER, OPTIONAL, INTENT(OUT) :: ierror`

MPI_WAIT(REQUEST, STATUS, IERROR)

INTEGER REQUEST, STATUS(MPI_STATUS_SIZE), IERROR

{void MPI::Request::Wait(MPI::Status& status) (*binding deprecated, see Section 15.2*) }

{void MPI::Request::Wait() (*binding deprecated, see Section 15.2*) }

A call to MPI_WAIT returns when the operation identified by request is complete. If the [communication object associated with this request was created by a nonblocking send or receive call, then the object]request is an active persistent request, it is marked inactive. Any other type of request is [deallocated by the call to MPI_WAIT] and the request handle is set to MPI_REQUEST_NULL. MPI_WAIT is a non-local operation.

The call returns, in status, information on the completed operation. The content of the status object for a receive operation can be accessed as described in Section 3.2.5. The status object for a send operation may be queried by a call to MPI_TEST_CANCELLED (see Section 3.8).

One is allowed to call MPI_WAIT with a null or inactive request argument. In this case the operation returns immediately with empty status.

Advice to users. Successful return of MPI_WAIT after a MPI_IBSEND implies that the user send buffer can be reused — i.e., data has been sent out or copied into a buffer attached with MPI_BUFFER_ATTACH. Note that, at this point, we can no longer cancel the send (see Section 3.8). If a matching receive is never posted, then the buffer cannot be freed. This runs somewhat counter to the stated goal of MPI_CANCEL (always being able to free program space that was committed to the communication subsystem). (*End of advice to users.*)

Advice to implementors. In a multi-threaded environment, a call to MPI_WAIT should block only the calling thread, allowing the thread scheduler to schedule another thread for execution. (*End of advice to implementors.*)

MPI_TEST(request, flag, status)

INOUT request communication request (handle)

OUT flag true if operation completed (logical)

OUT status status object (Status)

int MPI_Test(MPI_Request *request, int *flag, MPI_Status *status)

MPI_Test(request, flag, status, ierror) BIND(C)

TYPE(MPI_Request), INTENT(INOUT) :: request

LOGICAL, INTENT(OUT) :: flag

TYPE(MPI_Status) :: status

INTEGER, OPTIONAL, INTENT(OUT) :: ierror

MPI_TEST(REQUEST, FLAG, STATUS, IERROR)

LOGICAL FLAG

INTEGER REQUEST, STATUS(MPI_STATUS_SIZE), IERROR

```

1 {bool MPI::Request::Test(MPI::Status& status) (binding deprecated, see
2     Section 15.2) }
3
4 {bool MPI::Request::Test() (binding deprecated, see Section 15.2) }

```

A call to `MPI_TEST` returns `flag = true` if the operation identified by `request` is complete. In such a case, the status object is set to contain information on the completed operation [; if the communication object was created by a nonblocking send or receive, then it]. If the request is an active persistent request, it is marked as inactive. Any other type of request is deallocated and the request handle is set to `MPI_REQUEST_NULL`. The call returns `flag = false` [; otherwise.] if the operation identified by `request` is not complete. In this case, the value of the status object is undefined. `MPI_TEST` is a local operation.

The return status object for a receive operation carries information that can be accessed as described in Section 3.2.5. The status object for a send operation carries information that can be accessed by a call to `MPI_TEST_CANCELLED` (see Section 3.8).

One is allowed to call `MPI_TEST` with a null or inactive request argument. In such a case the operation returns with `flag = true` and empty `status`.

The functions `MPI_WAIT` and `MPI_TEST` can be used to complete both sends and receives.

Advice to users. The use of the nonblocking `MPI_TEST` call allows the user to schedule alternative activities within a single thread of execution. An event-driven thread scheduler can be emulated with periodic calls to `MPI_TEST`. (*End of advice to users.*)

Example 3.12 Simple usage of nonblocking operations and `MPI_WAIT`.

```

27 CALL MPI_COMM_RANK(comm, rank, ierr)
28 IF (rank.EQ.0) THEN
29     CALL MPI_ISEND(a(1), 10, MPI_REAL, 1, tag, comm, request, ierr)
30     **** do some computation to mask latency ****
31     CALL MPI_WAIT(request, status, ierr)
32 ELSE IF (rank.EQ.1) THEN
33     CALL MPI_IRecv(a(1), 15, MPI_REAL, 0, tag, comm, request, ierr)
34     **** do some computation to mask latency ****
35     CALL MPI_WAIT(request, status, ierr)
36 END IF

```

A request object can be deallocated without waiting for the associated communication to complete, by using the following operation.

```

41 MPI_REQUEST_FREE(request)
42     INOUT      request                communication request (handle)
43
44
45 int MPI_Request_free(MPI_Request *request)
46 MPI_Request_free(request, ierror) BIND(C)
47     TYPE(MPI_Request), INTENT(INOUT) :: request

```

```

    INTEGER, OPTIONAL, INTENT(OUT) :: ierror
MPI_REQUEST_FREE(REQUEST, IERROR)
    INTEGER REQUEST, IERROR
{void MPI::Request::Free() (binding deprecated, see Section 15.2) }

```

Mark the request object for deallocation and set `request` to `MPI_REQUEST_NULL`. An ongoing communication that is associated with the request will be allowed to complete. The request will be deallocated only after its completion.

Rationale. The `MPI_REQUEST_FREE` mechanism is provided for reasons of performance and convenience on the sending side. (*End of rationale.*)

Advice to users. Once a request is freed by a call to `MPI_REQUEST_FREE`, it is not possible to check for the successful completion of the associated communication with calls to `MPI_WAIT` or `MPI_TEST`. Also, if an error occurs subsequently during the communication, an error code cannot be returned to the user — such an error must be treated as fatal. An active receive request should never be freed as the receiver will have no way to verify that the receive has completed and the receive buffer can be reused. (*End of advice to users.*)

Example 3.13 An example using `MPI_REQUEST_FREE`.

```

CALL MPI_COMM_RANK(MPI_COMM_WORLD, rank, ierr)
IF (rank.EQ.0) THEN
    DO i=1, n
        CALL MPI_ISEND(outval, 1, MPI_REAL, 1, 0, MPI_COMM_WORLD, req, ierr)
        CALL MPI_REQUEST_FREE(req, ierr)
        CALL MPI_IRecv(inval, 1, MPI_REAL, 1, 0, MPI_COMM_WORLD, req, ierr)
        CALL MPI_WAIT(req, status, ierr)
    END DO
ELSE IF (rank.EQ.1) THEN
    CALL MPI_IRecv(inval, 1, MPI_REAL, 0, 0, MPI_COMM_WORLD, req, ierr)
    CALL MPI_WAIT(req, status, ierr)
    DO I=1, n-1
        CALL MPI_ISEND(outval, 1, MPI_REAL, 0, 0, MPI_COMM_WORLD, req, ierr)
        CALL MPI_REQUEST_FREE(req, ierr)
        CALL MPI_IRecv(inval, 1, MPI_REAL, 0, 0, MPI_COMM_WORLD, req, ierr)
        CALL MPI_WAIT(req, status, ierr)
    END DO
    CALL MPI_ISEND(outval, 1, MPI_REAL, 0, 0, MPI_COMM_WORLD, req, ierr)
    CALL MPI_WAIT(req, status, ierr)
END IF

```

3.7.4 Semantics of Nonblocking Communications

The semantics of nonblocking communication is defined by suitably extending the definitions in Section 3.5.

Order Nonblocking communication operations are ordered according to the execution order of the calls that initiate the communication. The non-overtaking requirement of Section 3.5 is extended to nonblocking communication, with this definition of order being used.

Example 3.14 Message ordering for nonblocking operations.

```

1 CALL MPI_COMM_RANK(comm, rank, ierr)
2 IF (RANK.EQ.0) THEN
3     CALL MPI_ISEND(a, 1, MPI_REAL, 1, 0, comm, r1, ierr)
4     CALL MPI_ISEND(b, 1, MPI_REAL, 1, 0, comm, r2, ierr)
5 ELSE IF (rank.EQ.1) THEN
6     CALL MPI_IRECV(a, 1, MPI_REAL, 0, MPI_ANY_TAG, comm, r1, ierr)
7     CALL MPI_IRECV(b, 1, MPI_REAL, 0, 0, comm, r2, ierr)
8 END IF
9 CALL MPI_WAIT(r1, status, ierr)
10 CALL MPI_WAIT(r2, status, ierr)

```

The first send of process zero will match the first receive of process one, even if both messages are sent before process one executes either receive.

Progress A call to MPI_WAIT that completes a receive will eventually terminate and return if a matching send has been started, unless the send is satisfied by another receive. In particular, if the matching send is nonblocking, then the receive should complete even if no call is executed by the sender to complete the send. Similarly, a call to MPI_WAIT that completes a send will eventually return if a matching receive has been started, unless the receive is satisfied by another send, and even if no call is executed to complete the receive.

Example 3.15 An illustration of progress semantics.

```

27 CALL MPI_COMM_RANK(comm, rank, ierr)
28 IF (RANK.EQ.0) THEN
29     CALL MPI_SSEND(a, 1, MPI_REAL, 1, 0, comm, ierr)
30     CALL MPI_SEND(b, 1, MPI_REAL, 1, 1, comm, ierr)
31 ELSE IF (rank.EQ.1) THEN
32     CALL MPI_IRECV(a, 1, MPI_REAL, 0, 0, comm, r, ierr)
33     CALL MPI_RECV(b, 1, MPI_REAL, 0, 1, comm, status, ierr)
34     CALL MPI_WAIT(r, status, ierr)
35 END IF
36

```

This code should not deadlock in a correct MPI implementation. The first synchronous send of process zero must complete after process one posts the matching (nonblocking) receive even if process one has not yet reached the completing wait call. Thus, process zero will continue and execute the second send, allowing process one to complete execution.

If an MPI_TEST that completes a receive is repeatedly called with the same arguments, and a matching send has been started, then the call will eventually return `flag = true`, unless the send is satisfied by another receive. If an MPI_TEST that completes a send is repeatedly called with the same arguments, and a matching receive has been started, then the call will eventually return `flag = true`, unless the receive is satisfied by another send.

3.7.5 Multiple Completions

It is convenient to be able to wait for the completion of any, some, or all the operations in a list, rather than having to wait for a specific message. A call to `MPI_WAITANY` or `MPI_TESTANY` can be used to wait for the completion of one out of several operations. A call to `MPI_WAITALL` or `MPI_TESTALL` can be used to wait for all pending operations in a list. A call to `MPI_WAITSOME` or `MPI_TESTSOME` can be used to complete all enabled operations in a list.

`MPI_WAITANY` (count, array_of_requests, index, status)

IN	count	list length (non-negative integer)
INOUT	array_of_requests	array of requests (array of handles)
OUT	index	index of handle for operation that completed (integer)
OUT	status	status object (Status)

```
int MPI_Waitany(int count, MPI_Request [*]array_of_requests[], int *index,
               MPI_Status *status)
```

```
MPI_Waitany(count, array_of_requests, index, status, ierror) BIND(C)
  INTEGER, INTENT(IN) :: count
  TYPE(MPI_Request), INTENT(INOUT) :: array_of_requests(count)
  INTEGER, INTENT(OUT) :: index
  TYPE(MPI_Status) :: status
  INTEGER, OPTIONAL, INTENT(OUT) :: ierror
```

```
MPI_WAITANY(COUNT, ARRAY_OF_REQUESTS, INDEX, STATUS, IERROR)
  INTEGER COUNT, ARRAY_OF_REQUESTS(*), INDEX, STATUS(MPI_STATUS_SIZE),
  IERROR
```

```
{static int MPI::Request::Waitany(int count,
  MPI::Request array_of_requests[], MPI::Status& status) (binding
  deprecated, see Section 15.2) }
```

```
{static int MPI::Request::Waitany(int count,
  MPI::Request array_of_requests[]) (binding deprecated, see
  Section 15.2) }
```

Blocks until one of the operations associated with the active requests in the array has completed. If more than one operation is enabled and can terminate, one is arbitrarily chosen. Returns in `index` the index of that request in the array and returns in `status` the status of the completing `[communication]operation`. (The array is indexed from zero in C, and from one in Fortran.) If the request `[was allocated by a nonblocking communication operation, then it]is an active persistent request, it is marked inactive. Any other type of request` is deallocated and the request handle is set to `MPI_REQUEST_NULL`.

The `array_of_requests` list may contain null or inactive handles. If the list contains no active handles (list has length zero or all entries are null or inactive), then the call returns immediately with `index = MPI_UNDEFINED`, and an empty `status`.

The execution of `MPI_WAITANY(count, array_of_requests, index, status)` has the same effect as the execution of `MPI_WAIT(&array_of_requests[i], status)`, where `i` is the value returned by `index` (unless the value of `index` is `MPI_UNDEFINED`). `MPI_WAITANY` with an array containing one active entry is equivalent to `MPI_WAIT`.

`MPI_TESTANY(count, array_of_requests, index, flag, status)`

IN	count	list length (non-negative integer)
INOUT	array_of_requests	array of requests (array of handles)
OUT	index	index of operation that completed, or <code>MPI_UNDEFINED</code> if none completed (integer)
OUT	flag	true if one of the operations is complete (logical)
OUT	status	status object (Status)

```
int MPI_Testany(int count, MPI_Request [*]array_of_requests[], int *index,
               int *flag, MPI_Status *status)
```

```
MPI_Testany(count, array_of_requests, index, flag, status, ierror) BIND(C)
  INTEGER, INTENT(IN) :: count
  TYPE(MPI_Request), INTENT(INOUT) :: array_of_requests(count)
  INTEGER, INTENT(OUT) :: index
  LOGICAL, INTENT(OUT) :: flag
  TYPE(MPI_Status) :: status
  INTEGER, OPTIONAL, INTENT(OUT) :: ierror
```

```
MPI_TESTANY(COUNT, ARRAY_OF_REQUESTS, INDEX, FLAG, STATUS, IERROR)
  LOGICAL FLAG
  INTEGER COUNT, ARRAY_OF_REQUESTS(*), INDEX, STATUS(MPI_STATUS_SIZE),
  IERROR
```

```
{static bool MPI::Request::Testany(int count,
  MPI::Request array_of_requests[], int& index,
  MPI::Status& status) (binding deprecated, see Section 15.2) }
```

```
{static bool MPI::Request::Testany(int count,
  MPI::Request array_of_requests[], int& index) (binding deprecated,
  see Section 15.2) }
```

Tests for completion of either one or none of the operations associated with active handles. In the former case, it returns `flag = true`, returns in `index` the index of this request in the array, and returns in `status` the status of that operation; if the request was allocated by a nonblocking communication call then the request. If the request is an active persistent request, it is marked as inactive. Any other type of request is deallocated and the handle is set to `MPI_REQUEST_NULL`. (The array is indexed from zero in C, and from one in Fortran.) In the latter case (no operation completed), it returns `flag = false`, returns a value of `MPI_UNDEFINED` in `index` and `status` is undefined.

The array may contain null or inactive handles. If the array contains no active handles then the call returns immediately with `flag = true`, `index = MPI_UNDEFINED`, and an empty status.

If the array of requests contains active handles then the execution of `MPI_TESTANY(count, array_of_requests, index, status)` has the same effect as the execution of `MPI_TEST(&array_of_requests[i], flag, status)`, for $i=0, 1, \dots, \text{count}-1$, in some arbitrary order, until one call returns `flag = true`, or all fail. In the former case, `index` is set to the last value of `i`, and in the latter case, it is set to `MPI_UNDEFINED`. `MPI_TESTANY` with an array containing one active entry is equivalent to `MPI_TEST`.

`MPI_WAITALL(count, array_of_requests, array_of_statuses)`

IN	count	lists length (non-negative integer)
INOUT	array_of_requests	array of requests (array of handles)
OUT	array_of_statuses	array of status objects (array of Status)

```
int MPI_Waitall(int count, MPI_Request [*]array_of_requests[],
               MPI_Status [*]array_of_statuses[])
```

```
MPI_Waitall(count, array_of_requests, array_of_statuses, ierror) BIND(C)
  INTEGER, INTENT(IN) :: count
  TYPE(MPI_Request), INTENT(INOUT) :: array_of_requests(count)
  TYPE(MPI_Status) :: array_of_statuses(*)
  INTEGER, OPTIONAL, INTENT(OUT) :: ierror
```

```
MPI_WAITALL(COUNT, ARRAY_OF_REQUESTS, ARRAY_OF_STATUSES, IERROR)
  INTEGER COUNT, ARRAY_OF_REQUESTS(*)
  INTEGER ARRAY_OF_STATUSES(MPI_STATUS_SIZE,*), IERROR
```

```
{static void MPI::Request::Waitall(int count,
  MPI::Request array_of_requests[],
  MPI::Status array_of_statuses[]) (binding deprecated, see
  Section 15.2) }
```

```
{static void MPI::Request::Waitall(int count,
  MPI::Request array_of_requests[]) (binding deprecated, see
  Section 15.2) }
```

Blocks until all communication operations associated with active handles in the list complete, and return the status of all these operations (this includes the case where no handle in the list is active). Both arrays have the same number of valid entries. The i -th entry in `array_of_statuses` is set to the return status of the i -th operation. **[Requests that were created by nonblocking communication operations] Active persistent requests are marked inactive. Requests of any other type are deallocated and the corresponding handles in the array are set to `MPI_REQUEST_NULL`.** The list may contain null or inactive handles. The call sets to empty the status of each such entry.

The error-free execution of `MPI_WAITALL(count, array_of_requests, array_of_statuses)` has the same effect as the execution of `MPI_WAIT(&array_of_request[i], &array_of_statuses[i])`, for $i=0, \dots, \text{count}-1$, in some arbitrary order. `MPI_WAITALL` with an array of length one is equivalent to `MPI_WAIT`.

When one or more of the communications completed by a call to `MPI_WAITALL` fail, it is desirable to return specific information on each communication. The function

MPI_WAITALL will return in such case the error code MPI_ERR_IN_STATUS and will set the error field of each status to a specific error code. This code will be MPI_SUCCESS, if the specific communication completed; it will be another specific error code, if it failed; or it can be MPI_ERR_PENDING if it has neither failed nor completed. The function MPI_WAITALL will return MPI_SUCCESS if no request had an error, or will return another error code if it failed for other reasons (such as invalid arguments). In such cases, it will not update the error fields of the statuses.

Rationale. This design streamlines error handling in the application. The application code need only test the (single) function result to determine if an error has occurred. It needs to check each individual status only when an error occurred. (*End of rationale.*)

MPI_TESTALL(count, array_of_requests, flag, array_of_statuses)

IN	count	lists length (non-negative integer)
INOUT	array_of_requests	array of requests (array of handles)
OUT	flag	(logical)
OUT	array_of_statuses	array of status objects (array of Status)

```
int MPI_Testall(int count, MPI_Request [*]array_of_requests[], int *flag,
                MPI_Status [*]array_of_statuses[])
```

```
MPI_Testall(count, array_of_requests, flag, array_of_statuses, ierror)
    BIND(C)
    INTEGER, INTENT(IN) :: count
    TYPE(MPI_Request), INTENT(INOUT) :: array_of_requests(count)
    LOGICAL, INTENT(OUT) :: flag
    TYPE(MPI_Status) :: array_of_statuses(*)
    INTEGER, OPTIONAL, INTENT(OUT) :: ierror
```

```
MPI_TESTALL(COUNT, ARRAY_OF_REQUESTS, FLAG, ARRAY_OF_STATUSES, IERROR)
    LOGICAL FLAG
    INTEGER COUNT, ARRAY_OF_REQUESTS(*),
    ARRAY_OF_STATUSES(MPI_STATUS_SIZE,*), IERROR
```

```
{static bool MPI::Request::Testall(int count,
    MPI::Request array_of_requests[],
    MPI::Status array_of_statuses[]) (binding deprecated, see
    Section 15.2) }
```

```
{static bool MPI::Request::Testall(int count,
    MPI::Request array_of_requests[]) (binding deprecated, see
    Section 15.2) }
```

Returns `flag = true` if all communications associated with active handles in the array have completed (this includes the case where no handle in the list is active). In this case, each status entry that corresponds to an active `[handle]request` is set to the status of the corresponding `[communication; if the request was allocated by a nonblocking communication`

call then it is deallocated, and the handle is]operation. Active persistent requests are marked inactive. Requests of any other type are deallocated and the corresponding handles in the array are set to MPI_REQUEST_NULL. Each status entry that corresponds to a null or inactive handle is set to empty.

Otherwise, flag = false is returned, no request is modified and the values of the status entries are undefined. This is a local operation.

Errors that occurred during the execution of MPI_TESTALL are handled as errors in MPI_WAITALL.

MPI_WAITSSOME(incount, array_of_requests, outcount, array_of_indices, array_of_statuses)

IN	incount	length of array_of_requests (non-negative integer)
INOUT	array_of_requests	array of requests (array of handles)
OUT	outcount	number of completed requests (integer)
OUT	array_of_indices	array of indices of operations that completed (array of integers)
OUT	array_of_statuses	array of status objects for operations that completed (array of Status)

```
int MPI_Waitssome(int incount, MPI_Request [*]array_of_requests [],
                 int *outcount, int [*]array_of_indices [],
                 MPI_Status [*]array_of_statuses [])
```

```
MPI_Waitssome(incount, array_of_requests, outcount, array_of_indices,
              array_of_statuses, ierror) BIND(C)
```

```
INTEGER, INTENT(IN) :: incount
TYPE(MPI_Request), INTENT(INOUT) :: array_of_requests(incount)
INTEGER, INTENT(OUT) :: outcount, array_of_indices(*)
TYPE(MPI_Status) :: array_of_statuses(*)
INTEGER, OPTIONAL, INTENT(OUT) :: ierror
```

```
MPI_WAITSSOME(INCOUNT, ARRAY_OF_REQUESTS, OUTCOUNT, ARRAY_OF_INDICES,
              ARRAY_OF_STATUSES, IERROR)
INTEGER INCOUNT, ARRAY_OF_REQUESTS(*), OUTCOUNT, ARRAY_OF_INDICES(*),
ARRAY_OF_STATUSES(MPI_STATUS_SIZE,*), IERROR
```

```
{static int MPI::Request::Waitssome(int incount,
MPI::Request array_of_requests [], int array_of_indices [],
MPI::Status array_of_statuses []) (binding deprecated, see
Section 15.2) }
```

```
{static int MPI::Request::Waitssome(int incount,
MPI::Request array_of_requests [],
int array_of_indices []) (binding deprecated, see Section 15.2) }
```

Waits until at least one of the operations associated with active handles in the list have completed. Returns in outcount the number of requests from the list array_of_requests that

1 have completed. Returns in the first outcount locations of the array `array_of_indices` the
 2 indices of these operations (index within the array `array_of_requests`; the array is indexed
 3 from zero in C and from one in Fortran). Returns in the first outcount locations of the array
 ticket321. 4 `array_of_status` the status for these completed operations. [If a request that completed was
 5 allocated by a nonblocking communication call, then it] Completed active persistent requests
 6 are marked as inactive. Any other type or request that completed is deallocated, and the
 7 associated handle is set to `MPI_REQUEST_NULL`.

8 If the list contains no active handles, then the call returns immediately with `outcount`
 9 = `MPI_UNDEFINED`.

10 When one or more of the communications completed by `MPI_WAITSSOME` fails, then
 11 it is desirable to return specific information on each communication. The arguments
 12 `outcount`, `array_of_indices` and `array_of_statuses` will be adjusted to indicate completion of
 13 all communications that have succeeded or failed. The call will return the error code
 14 `MPI_ERR_IN_STATUS` and the error field of each status returned will be set to indicate
 15 success or to indicate the specific error that occurred. The call will return `MPI_SUCCESS`
 16 if no request resulted in an error, and will return another error code if it failed for other
 17 reasons (such as invalid arguments). In such cases, it will not update the error fields of the
 18 statuses.

19
 20
 21 `MPI_TESTSSOME`(`incount`, `array_of_requests`, `outcount`, `array_of_indices`, `array_of_statuses`)

22			
23	IN	<code>incount</code>	length of <code>array_of_requests</code> (non-negative integer)
24	INOUT	<code>array_of_requests</code>	array of requests (array of handles)
25			
26	OUT	<code>outcount</code>	number of completed requests (integer)
27	OUT	<code>array_of_indices</code>	array of indices of operations that completed (array of 28 integers)
29			
30	OUT	<code>array_of_statuses</code>	array of status objects for operations that completed 31 (array of Status)

32
 ticket125. 33 `int MPI_Testsome(int incount, MPI_Request [*]array_of_requests [],`
 ticket125. 34 `int *outcount, int [*]array_of_indices [],`
 ticket125. 35 `MPI_Status [*]array_of_statuses [])`

36 `MPI_Testsome(incount, array_of_requests, outcount, array_of_indices,`
 ticket125. 37 `array_of_statuses, ierror) BIND(C)`

ticket-248T. 38 `INTEGER, INTENT(IN) :: incount`
 39 `TYPE(MPI_Request), INTENT(INOUT) :: array_of_requests(incount)`
 40 `INTEGER, INTENT(OUT) :: outcount, array_of_indices(*)`
 41 `TYPE(MPI_Status) :: array_of_statuses(*)`
 42 `INTEGER, OPTIONAL, INTENT(OUT) :: ierror`

43
 44 `MPI_TESTSSOME(INCOUNT, ARRAY_OF_REQUESTS, OUTCOUNT, ARRAY_OF_INDICES,`
 45 `ARRAY_OF_STATUSES, IERROR)`
 46 `INTEGER INCOUNT, ARRAY_OF_REQUESTS(*), OUTCOUNT, ARRAY_OF_INDICES(*),`
 47 `ARRAY_OF_STATUSES(MPI_STATUS_SIZE,*), IERROR`

```

{static int MPI::Request::Testsome(int incout,
    MPI::Request array_of_requests[], int array_of_indices[],
    MPI::Status array_of_statuses[]) (binding deprecated, see
    Section 15.2) }
{static int MPI::Request::Testsome(int incout,
    MPI::Request array_of_requests[],
    int array_of_indices[]) (binding deprecated, see Section 15.2) }

```

Behaves like MPI_WAITSSOME, except that it returns immediately. If no operation has completed it returns `outcount = 0`. If there is no active handle in the list it returns `outcount = MPI_UNDEFINED`.

MPI_TESTSSOME is a local operation, which returns immediately, whereas MPI_WAITSSOME will block until a communication completes, if it was passed a list that contains at least one active handle. Both calls fulfill a fairness requirement: If a request for a receive repeatedly appears in a list of requests passed to MPI_WAITSSOME or MPI_TESTSSOME, and a matching send has been posted, then the receive will eventually succeed, unless the send is satisfied by another receive; and similarly for send requests.

Errors that occur during the execution of MPI_TESTSSOME are handled as for MPI_WAITSSOME.

Advice to users. The use of MPI_TESTSSOME is likely to be more efficient than the use of MPI_TESTANY. The former returns information on all completed communications, with the latter, a new call is required for each communication that completes.

A server with multiple clients can use MPI_WAITSSOME so as not to starve any client. Clients send messages to the server with service requests. The server calls MPI_WAITSSOME with one receive request for each client, and then handles all receives that completed. If a call to MPI_WAITANY is used instead, then one client could starve while requests from another client always sneak in first. (*End of advice to users.*)

Advice to implementors. MPI_TESTSSOME should complete as many pending communications as possible. (*End of advice to implementors.*)

Example 3.16 Client-server code (starvation can occur).

```

CALL MPI_COMM_SIZE(comm, size, ierr)
CALL MPI_COMM_RANK(comm, rank, ierr)
IF(rank .GT. 0) THEN          ! client code
  DO WHILE(.TRUE.)
    CALL MPI_ISEND(a, n, MPI_REAL, 0, tag, comm, request, ierr)
    CALL MPI_WAIT(request, status, ierr)
  END DO
ELSE          ! rank=0 -- server code
  DO i=1, size-1
    CALL MPI_IRecv(a(1,i), n, MPI_REAL, i, tag,
      comm, request_list(i), ierr)
  END DO
  DO WHILE(.TRUE.)

```

```

1      CALL MPI_WAITANY(size-1, request_list, index, status, ierr)
2      CALL DO_SERVICE(a(1,index)) ! handle one message
3      CALL MPI_Irecv(a(1, index), n, MPI_REAL, index, tag,
4                  comm, request_list(index), ierr)
5  END DO
6  END IF
7
8

```

Example 3.17 Same code, using MPI_WAITSSOME.

```

10
11 CALL MPI_COMM_SIZE(comm, size, ierr)
12 CALL MPI_COMM_RANK(comm, rank, ierr)
13 IF(rank .GT. 0) THEN ! client code
14   DO WHILE(.TRUE.)
15     CALL MPI_ISEND(a, n, MPI_REAL, 0, tag, comm, request, ierr)
16     CALL MPI_WAIT(request, status, ierr)
17   END DO
18 ELSE ! rank=0 -- server code
19   DO i=1, size-1
20     CALL MPI_Irecv(a(1,i), n, MPI_REAL, i, tag,
21                 comm, request_list(i), ierr)
22   END DO
23   DO WHILE(.TRUE.)
24     CALL MPI_WAITSSOME(size, request_list, numdone,
25                     indices, statuses, ierr)
26     DO i=1, numdone
27       CALL DO_SERVICE(a(1, indices(i)))
28       CALL MPI_Irecv(a(1, indices(i)), n, MPI_REAL, 0, tag,
29                   comm, request_list(indices(i)), ierr)
30     END DO
31   END DO
32 END IF
33
34

```

3.7.6 Non-destructive Test of status

This call is useful for accessing the information associated with a request, without freeing the request (in case the user is expected to access it later). It allows one to layer libraries more conveniently, since multiple layers of software may access the same completed request and extract from it the status information.

MPI_REQUEST_GET_STATUS(request, flag, status)

IN	request	request (handle)
OUT	flag	boolean flag, same as from MPI_TEST (logical)
OUT	status	MPI_STATUS object if flag is true (Status)

```

int MPI_Request_get_status(MPI_Request request, int *flag,
                           MPI_Status *status)
MPI_Request_get_status(request, flag, status, ierror) BIND(C)
  TYPE(MPI_Request), INTENT(IN) :: request
  LOGICAL, INTENT(OUT) :: flag
  TYPE(MPI_Status) :: status
  INTEGER, OPTIONAL, INTENT(OUT) :: ierror
MPI_REQUEST_GET_STATUS( REQUEST, FLAG, STATUS, IERROR)
  INTEGER REQUEST, STATUS(MPI_STATUS_SIZE), IERROR
  LOGICAL FLAG
{bool MPI::Request::Get_status(MPI::Status& status) const(binding deprecated,
  see Section 15.2) }
{bool MPI::Request::Get_status() const(binding deprecated, see Section 15.2) }

```

Sets `flag=true` if the operation is complete, and, if so, returns in `status` the request status. However, unlike `test` or `wait`, it does not deallocate or inactivate the request; a subsequent call to `test`, `wait` or `free` should be executed with that request. It sets `flag=false` if the operation is not complete.

One is allowed to call `MPI_REQUEST_GET_STATUS` with a null or inactive request argument. In such a case the operation returns with `flag=true` and empty status.

3.8 Probe and Cancel

The `MPI_PROBE[and]`, `MPI_IPROBE[]`, `MPI_MPROBE`, and `MPI_IMPROBE` operations allow incoming messages to be checked for, without actually receiving them. The user can then decide how to receive them, based on the information returned by the probe (basically, the information returned by `status`). In particular, the user may allocate memory for the receive buffer, according to the length of the probed message.

The `MPI_CANCEL` operation allows pending communications to be canceled. This is required for cleanup. Posting a send or a receive ties up user resources (send or receive buffers), and a cancel may be needed to free these resources gracefully.

3.8.1 Probe

```

MPI_IPROBE(source, tag, comm, flag, status)
  IN      source      rank of source or MPI_ANY_SOURCE (integer)
  IN      tag         message tag or MPI_ANY_TAG (integer)
  IN      comm        communicator (handle)
  OUT     flag        (logical)
  OUT     status      status object (Status)
int MPI_Iprobe(int source, int tag, MPI_Comm comm, int *flag,
               MPI_Status *status)

```

```

1
2 MPI_Iprobe(source, tag, comm, flag, status, ierror) BIND(C)
3     INTEGER, INTENT(IN) :: source, tag
4     TYPE(MPI_Comm), INTENT(IN) :: comm
5     LOGICAL, INTENT(OUT) :: flag
6     TYPE(MPI_Status) :: status
7     INTEGER, OPTIONAL, INTENT(OUT) :: ierror

```

```

8 MPI_IPROBE(SOURCE, TAG, COMM, FLAG, STATUS, IERROR)
9     LOGICAL FLAG
10    INTEGER SOURCE, TAG, COMM, STATUS(MPI_STATUS_SIZE), IERROR

```

```

12 {bool MPI::Comm::Iprobe(int source, int tag, MPI::Status& status)
13     const(binding deprecated, see Section 15.2) }

```

```

14 {bool MPI::Comm::Iprobe(int source, int tag) const(binding deprecated, see
15     Section 15.2) }

```

MPI_IPROBE(source, tag, comm, flag, status) returns flag = true if there is a message that can be received and that matches the pattern specified by the arguments source, tag, and comm. The call matches the same message that would have been received by a call to MPI_RECV(..., source, tag, comm, status) executed at the same point in the program, and returns in status the same value that would have been returned by MPI_RECV(). Otherwise, the call returns flag = false, and leaves status undefined.

If MPI_IPROBE returns flag = true, then the content of the status object can be subsequently accessed as described in Section 3.2.5 to find the source, tag and length of the probed message.

A subsequent receive executed with the same communicator, and the source and tag returned in status by MPI_IPROBE will receive the message that was matched by the probe, if no other intervening receive occurs after the probe, and the send is not successfully cancelled before the receive. If the receiving process is multi-threaded, it is the user's responsibility to ensure that the last condition holds.

The source argument of MPI_PROBE can be MPI_ANY_SOURCE, and the tag argument can be MPI_ANY_TAG, so that one can probe for messages from an arbitrary source and/or with an arbitrary tag. However, a specific communication context must be provided with the comm argument.

It is not necessary to receive a message immediately after it has been probed for, and the same message may be probed for several times before it is received.

```

39 MPI_PROBE(source, tag, comm, status)
40     IN        source                rank of source or MPI_ANY_SOURCE (integer)
41     IN        tag                   message tag or MPI_ANY_TAG (integer)
42     IN        comm                  communicator (handle)
43     OUT       status                status object (Status)

```

```

46 int MPI_Probe(int source, int tag, MPI_Comm comm, MPI_Status *status)

```

```

48 MPI_Probe(source, tag, comm, status, ierror) BIND(C)

```



```

    INTEGER, INTENT(IN) :: source, tag
    TYPE(MPI_Comm), INTENT(IN) :: comm
    TYPE(MPI_Status) :: status
    INTEGER, OPTIONAL, INTENT(OUT) :: ierror
MPI_PROBE(SOURCE, TAG, COMM, STATUS, IERROR)
    INTEGER SOURCE, TAG, COMM, STATUS(MPI_STATUS_SIZE), IERROR
{void MPI::Comm::Probe(int source, int tag, MPI::Status& status)
    const(binding deprecated, see Section 15.2) }
{void MPI::Comm::Probe(int source, int tag) const(binding deprecated, see
    Section 15.2) }

```

MPI_PROBE behaves like MPI_IPROBE except that it is a blocking call that returns only after a matching message has been found.

The MPI implementation of MPI_PROBE and MPI_IPROBE needs to guarantee progress: if a call to MPI_PROBE has been issued by a process, and a send that matches the probe has been initiated by some process, then the call to MPI_PROBE will return, unless the message is received by another concurrent receive operation (that is executed by another thread at the probing process). Similarly, if a process busy waits with MPI_IPROBE and a matching message has been issued, then the call to MPI_IPROBE will eventually return flag = true unless the message is received by another concurrent receive operation or matched by a concurrent matched probe. ticket38.

Example 3.18

Use blocking probe to wait for an incoming message.

```

    CALL MPI_COMM_RANK(comm, rank, ierr)
    IF (rank.EQ.0) THEN
        CALL MPI_SEND(i, 1, MPI_INTEGER, 2, 0, comm, ierr)
    ELSE IF (rank.EQ.1) THEN
        CALL MPI_SEND(x, 1, MPI_REAL, 2, 0, comm, ierr)
    ELSE IF (rank.EQ.2) THEN
        DO i=1, 2
            CALL MPI_PROBE(MPI_ANY_SOURCE, 0,
                comm, status, ierr)
            IF (status(MPI_SOURCE) .EQ. 0) THEN
100         CALL MPI_RECV(i, 1, MPI_INTEGER, 0, 0, comm, status, ierr)
            ELSE
200         CALL MPI_RECV(x, 1, MPI_REAL, 1, 0, comm, status, ierr)
            END IF
        END DO
    END IF

```

Each message is received with the right type.

Example 3.19 A similar program to the previous example, but now it has a problem.

```

1      CALL MPI_COMM_RANK(comm, rank, ierr)
2      IF (rank.EQ.0) THEN
3          CALL MPI_SEND(i, 1, MPI_INTEGER, 2, 0, comm, ierr)
4      ELSE IF (rank.EQ.1) THEN
5          CALL MPI_SEND(x, 1, MPI_REAL, 2, 0, comm, ierr)
6      ELSE IF (rank.EQ.2) THEN
7          DO i=1, 2
8              CALL MPI_PROBE(MPI_ANY_SOURCE, 0,
9                          comm, status, ierr)
10             IF (status(MPI_SOURCE) .EQ. 0) THEN
11 100                CALL MPI_RECV(i, 1, MPI_INTEGER, MPI_ANY_SOURCE,
12                        0, comm, status, ierr)
13             ELSE
14 200                CALL MPI_RECV(x, 1, MPI_REAL, MPI_ANY_SOURCE,
15                        0, comm, status, ierr)
16             END IF
17         END DO
18     END IF

```

ticket262.

[We slightly modified Example 3.18, using `MPI_ANY_SOURCE` as the source argument in the two receive calls in statements labeled 100 and 200. The program is now incorrect: the receive operation may receive a message that is distinct from the message probed by the preceding call to `MPI_PROBE`.] In Example 3.19, the two receive calls in statements labeled 100 and 200 in Example 3.18 slightly modified, using `MPI_ANY_SOURCE` as the source argument. The program is now incorrect: the receive operation may receive a message that is distinct from the message probed by the preceding call to `MPI_PROBE`.

ticket38.

Advice to users. In a multithreaded MPI program, `MPI_PROBE` and `MPI_IProbe` might need special care. If a thread probes for a message and then immediately posts a matching receive, the receive may match a message other than that found by the probe since another thread could concurrently receive that original message [29]. `MPI_MProbe` and `MPI_IProbe` solve this problem by matching the incoming message so that it may only be received with `MPI_MRecv` or `MPI_IProbe` on the corresponding message handle. (*End of advice to users.*)

Advice to implementors. A call to `MPI_PROBE(source, tag, comm, status)` will match the message that would have been received by a call to `MPI_RECV(..., source, tag, comm, status)` executed at the same point. Suppose that this message has source `s`, tag `t` and communicator `c`. If the tag argument in the probe call has value `MPI_ANY_TAG` then the message probed will be the earliest pending message from source `s` with communicator `c` and any tag; in any case, the message probed will be the earliest pending message from source `s` with tag `t` and communicator `c` (this is the message that would have been received, so as to preserve message order). This message continues as the earliest pending message from source `s` with tag `t` and communicator `c`, until it is received. A receive operation subsequent to the probe that uses the same communicator as the probe and uses the tag and source values returned by the probe, must receive this message, unless it has already been received by another receive operation. (*End of advice to implementors.*)

ticket38.

3.8.2 Matching Probe

The function `MPI_PROBE` checks for incoming messages without receiving them. Since the list of incoming messages is global among the threads of each MPI process, it can be hard to use this functionality in threaded environments [29, 26].

Like `MPI_PROBE` and `MPI_IPROBE`, the `MPI_MPROBE` and `MPI_IMPROBE` operations allow incoming messages to be queried without actually receiving them, except that `MPI_MPROBE` and `MPI_IMPROBE` provide a mechanism to receive the specific message that was matched regardless of other intervening probe or receive operations. This gives the application an opportunity to decide how to receive the message, based on the information returned by the probe. In particular, the user may allocate memory for the receive buffer, according to the length of the probed message.

```
MPI_IMPROBE(source, tag, comm, flag, message, status)
```

IN	source	rank of source or <code>MPI_ANY_SOURCE</code> (integer)
IN	tag	message tag or <code>MPI_ANY_TAG</code> (integer)
IN	comm	communicator (handle)
OUT	flag	flag (logical)
OUT	message	returned message (handle)
OUT	status	status object (<code>Status</code>)

```
int MPI_Improbe(int source, int tag, MPI_Comm comm, int *flag,
                MPI_Message *message, MPI_Status *status)
```

```
MPI_Improbe(source, tag, comm, flag, message, status, ierror) BIND(C)
    INTEGER, INTENT(IN) :: source, tag
    TYPE(MPI_Comm), INTENT(IN) :: comm
    INTEGER, INTENT(OUT) :: flag
    TYPE(MPI_Message), INTENT(OUT) :: message
    TYPE(MPI_Status) :: status
    INTEGER, OPTIONAL, INTENT(OUT) :: ierror
```

```
MPI_IMPROBE(SOURCE, TAG, COMM, FLAG, MESSAGE, STATUS, IERROR)
    INTEGER SOURCE, TAG, COMM, FLAG, MESSAGE, STATUS(MPI_STATUS_SIZE),
    IERROR
```

`MPI_IMPROBE(source, tag, comm, flag, message, status)` returns `flag = true` if there is a message that can be received and that matches the pattern specified by the arguments `source`, `tag`, and `comm`. The call matches the same message that would have been received by a call to `MPI_RECV(..., source, tag, comm, status)` executed at the same point in the program and returns in `status` the same value that would have been returned by `MPI_RECV`. In addition, it returns in `message` a handle to the matched message. Otherwise, the call returns `flag = false`, and leaves `status` and `message` undefined.

A matched receive (`MPI_MRECV` or `MPI_IMRECV`) executed with the message handle will receive the message that was matched by the probe. Unlike `MPI_IPROBE`, no other probe or receive operation may match the message returned by `MPI_IMPROBE`.

ticket-248T.

Each message returned by `MPI_IMPROBE` must be received with either `MPI_MRECV` or `MPI_IMRECV`.

The source argument of `MPI_IMPROBE` can be `MPI_ANY_SOURCE`, and the tag argument can be `MPI_ANY_TAG`, so that one can probe for messages from an arbitrary source and/or with an arbitrary tag. However, a specific communication context must be provided with the `comm` argument.

A synchronous send operation that is matched with `MPI_IMPROBE` or `MPI_MPROBE` will complete successfully only if both a matching receive is posted with `MPI_MRECV` or `MPI_IMRECV`, and the receive operation has started to receive the message sent by the synchronous send.

A matching probe with `MPI_PROC_NULL` as source returns `flag = true`, `message = MPI_MESSAGE_NULL`, and the status object returns `source = MPI_PROC_NULL`, `tag = MPI_ANY_TAG`, and `count = 0`; see Section 3.11.

`MPI_MPROBE(source, tag, comm, message, status)`

IN	source	rank of source or <code>MPI_ANY_SOURCE</code> (integer)
IN	tag	message tag or <code>MPI_ANY_TAG</code> (integer)
IN	comm	communicator (handle)
OUT	message	returned message (handle)
OUT	status	status object (Status)

```
int MPI_Mprobe(int source, int tag, MPI_Comm comm, MPI_Message *message,
               MPI_Status *status)
```

```
MPI_Mprobe(source, tag, comm, message, status, ierror) BIND(C)
  INTEGER, INTENT(IN) :: source, tag
  TYPE(MPI_Comm), INTENT(IN) :: comm
  TYPE(MPI_Message), INTENT(OUT) :: message
  TYPE(MPI_Status) :: status
  INTEGER, OPTIONAL, INTENT(OUT) :: ierror
```

```
MPI_MPROBE(SOURCE, TAG, COMM, MESSAGE, STATUS, IERROR)
  INTEGER SOURCE, TAG, COMM, MESSAGE, STATUS(MPI_STATUS_SIZE), IERROR
```

`MPI_MPROBE` behaves like `MPI_IMPROBE` except that it is a blocking call that returns only after a matching message has been found.

The implementation of `MPI_MPROBE` and `MPI_IMPROBE` needs to guarantee progress in the same way as in the case of `MPI_PROBE` and `MPI_IPROBE`.

3.8.3 Matched Receives

The functions `MPI_MRECV` and `MPI_IMRECV` receive messages that have been previously matched by a matching probe (Section 3.8.2).

`MPI_MRECV(buf, count, datatype, message, status)`

OUT	buf	initial address of receive buffer (choice)
IN	count	number of elements in receive buffer (non-negative integer)
IN	datatype	datatype of each receive buffer element (handle)
INOUT	message	message (handle)
OUT	status	status object (Status)

```
int MPI_Mrecv(void* buf, int count, MPI_Datatype datatype,
             MPI_Message *message, MPI_Status *status)
```

```
MPI_Mrecv(buf, count, datatype, message, status, ierror) BIND(C)
```

```
TYPE(*), DIMENSION(..) :: buf
INTEGER, INTENT(IN) :: count
TYPE(MPI_Datatype), INTENT(IN) :: datatype
TYPE(MPI_Message), INTENT(INOUT) :: message
TYPE(MPI_Status) :: status
INTEGER, OPTIONAL, INTENT(OUT) :: ierror
```

```
MPI_MRECV(BUF, COUNT, DATATYPE, MESSAGE, STATUS, IERROR)
```

```
<type> BUF(*)
INTEGER COUNT, DATATYPE, MESSAGE, STATUS(MPI_STATUS_SIZE), IERROR
```

This call receives a message matched by a matching probe operation (Section 3.8.2).

The receive buffer consists of the storage containing `count` consecutive elements of the type specified by `datatype`, starting at address `buf`. The length of the received message must be less than or equal to the length of the receive buffer. An overflow error occurs if all incoming data does not fit, without truncation, into the receive buffer.

If the message is shorter than the receive buffer, then only those locations corresponding to the (shorter) message are modified.

On return from this function, the message handle is set to `MPI_MESSAGE_NULL`. All errors that occur during the execution of this operation are handled according to the error handler set for the communicator used in the matching probe call that produced the message handle.

If `MPI_MRECV` is called with `MPI_MESSAGE_NULL` as the message argument, the call returns immediately with the status object set to `source = MPI_PROC_NULL`, `tag = MPI_ANY_TAG`, and `count = 0`, as if a receive from `MPI_PROC_NULL` was issued, see Section 3.11.

ticket-248T.

```

1 MPI_IMRECV(buf, count, datatype, message, request)
2     OUT    buf                initial address of receive buffer (choice)
3
4     IN     count              number of elements in receive buffer (non-negative in-
5                               teger)
6
6     IN     datatype           datatype of each receive buffer element (handle)
7
7     INOUT  message            message (handle)
8
8     OUT    request            communication request (handle)
9

```

```

10
11 int MPI_Imrecv(void* buf, int count, MPI_Datatype datatype,
12               MPI_Message *message, MPI_Request *request)

```

```

13 MPI_Imrecv(buf, count, datatype, message, request, ierror) BIND(C)
14     TYPE(*), DIMENSION(..), ASYNCHRONOUS :: buf
15     INTEGER, INTENT(IN) :: count
16     TYPE(MPI_Datatype), INTENT(IN) :: datatype
17     TYPE(MPI_Message), INTENT(INOUT) :: message
18     TYPE(MPI_Request), INTENT(OUT) :: request
19     INTEGER, OPTIONAL, INTENT(OUT) :: ierror
20

```

```

21 MPI_IMRECV(BUF, COUNT, DATATYPE, MESSAGE, REQUEST, IERROR)
22     <type> BUF(*)
23     INTEGER COUNT, DATATYPE, MESSAGE, REQUEST, IERROR
24

```

MPI_IMRECV is the nonblocking variant of MPI_MRECV and starts a nonblocking receive of a matched message. Completion semantics are similar to MPI_IRECV as described in Section 3.7.2. On return from this function, the message handle is set to MPI_MESSAGE_NULL.

Advice to implementors. If reception of a matched message is started with MPI_IMRECV, then it is possible to cancel the returned request with MPI_CANCEL. If MPI_CANCEL succeeds, the matched message must be found by a subsequent message probe (MPI_PROBE, MPI_IPROBE, MPI_MPROBE, or MPI_IMPROBE), received by a subsequent receive operation or canceled by the sender. See Section 3.8.4 for details about MPI_CANCEL. The cancellation of operations initiated with MPI_IMRECV may fail. (*End of advice to implementors.*)

3.8.4 Cancel

```

40 MPI_CANCEL(request)
41     IN     request            communication request (handle)
42

```

```

43
44 int MPI_Cancel(MPI_Request *request)

```

```

45 MPI_Cancel(request, ierror) BIND(C)
46     TYPE(MPI_Request), INTENT(IN) :: request
47     INTEGER, OPTIONAL, INTENT(OUT) :: ierror
48

```

```
MPI_CANCEL(REQUEST, IERROR)
    INTEGER REQUEST, IERROR
```

```
{void MPI::Request::Cancel() const(binding deprecated, see Section 15.2) }
```

A call to MPI_CANCEL marks for cancellation a pending, nonblocking communication operation (send or receive). The cancel call is local. It returns immediately, possibly before the communication is actually canceled. It is still necessary to complete a communication that has been marked for cancellation, using a call to MPI_REQUEST_FREE, MPI_WAIT or MPI_TEST (or any of the derived operations).

If a communication is marked for cancellation, then a MPI_WAIT call for that communication is guaranteed to return, irrespective of the activities of other processes (i.e., MPI_WAIT behaves as a local function); similarly if MPI_TEST is repeatedly called in a busy wait loop for a canceled communication, then MPI_TEST will eventually be successful.

MPI_CANCEL can be used to cancel a communication that uses a persistent request (see Section 3.9), in the same way it is used for nonpersistent requests. A successful cancellation cancels the active communication, but not the request itself. After the call to MPI_CANCEL and the subsequent call to MPI_WAIT or MPI_TEST, the request becomes inactive and can be activated for a new communication.

The successful cancellation of a buffered send frees the buffer space occupied by the pending message.

Either the cancellation succeeds, or the communication succeeds, but not both. If a send is marked for cancellation, then it must be the case that either the send completes normally, in which case the message sent was received at the destination process, or that the send is successfully canceled, in which case no part of the message was received at the destination. Then, any matching receive has to be satisfied by another send. If a receive is marked for cancellation, then it must be the case that either the receive completes normally, or that the receive is successfully canceled, in which case no part of the receive buffer is altered. Then, any matching send has to be satisfied by another receive.

If the operation has been canceled, then information to that effect will be returned in the status argument of the operation that completes the communication.

Rationale. Although the IN request handle parameter should not need to be passed by reference, the C binding has listed the argument type as MPI_Request* since MPI-1.0. This function signature therefore cannot be changed without breaking existing MPI applications. (*End of rationale.*)

```
MPI_TEST_CANCELLED(status, flag)
```

```
IN      status          status object (Status)
OUT     flag            (logical)
```

```
int MPI_Test_cancelled(const MPI_Status *status, int *flag)
```

```
MPI_Test_cancelled(status, flag, ierror) BIND(C)
    TYPE(MPI_Status), INTENT(IN) :: status
    LOGICAL, INTENT(OUT) :: flag
```

ticket140.
ticket-248T.

```

1     INTEGER, OPTIONAL, INTENT(OUT) :: ierror
2
3     MPI_TEST_CANCELLED(STATUS, FLAG, IERROR)
4         LOGICAL FLAG
5         INTEGER STATUS(MPI_STATUS_SIZE), IERROR
6
7     {bool MPI::Status::Is_cancelled() const(binding deprecated, see Section 15.2) }

```

Returns `flag = true` if the communication associated with the status object was canceled successfully. In such a case, all other fields of `status` (such as `count` or `tag`) are undefined. Returns `flag = false`, otherwise. If a receive operation might be canceled then one should call `MPI_TEST_CANCELLED` first, to check whether the operation was canceled, before checking on the other fields of the return status.

Advice to users. Cancel can be an expensive operation that should be used only exceptionally. (*End of advice to users.*)

Advice to implementors. If a send operation uses an “eager” protocol (data is transferred to the receiver before a matching receive is posted), then the cancellation of this send may require communication with the intended receiver in order to free allocated buffers. On some systems this may require an interrupt to the intended receiver. Note that, while communication may be needed to implement `MPI_CANCEL`, this is still a local operation, since its completion does not depend on the code executed by other processes. If processing is required on another process, this should be transparent to the application (hence the need for an interrupt and an interrupt handler). (*End of advice to implementors.*)

3.9 Persistent Communication Requests

Often a communication with the same argument list is repeatedly executed within the inner loop of a parallel computation. In such a situation, it may be possible to optimize the communication by binding the list of communication arguments to a **persistent** communication request once and, then, repeatedly using the request to initiate and complete messages. The persistent request thus created can be thought of as a communication port or a “half-channel.” It does not provide the full functionality of a conventional channel, since there is no binding of the send port to the receive port. This construct allows reduction of the overhead for communication between the process and communication controller, but not of the overhead for communication between one communication controller and another. It is not necessary that messages sent with a persistent request be received by a receive operation using a persistent request, or vice versa.

A persistent communication request is created using one of the five following calls. These calls involve no communication.

```

MPI_SEND_INIT(buf, count, datatype, dest, tag, comm, request) 1
    IN      buf          initial address of send buffer (choice) 2
    IN      count        number of elements sent (non-negative integer) 3
    IN      datatype     type of each element (handle) 4
    IN      dest         rank of destination (integer) 5
    IN      tag          message tag (integer) 6
    IN      comm         communicator (handle) 7
    OUT     request      communication request (handle) 8
                                                                9
int MPI_Send_init(const void* buf, int count, MPI_Datatype datatype, 10
                  int dest, int tag, MPI_Comm comm, MPI_Request *request) 11
                                                                12
                                                                13 ticket140.
MPI_Send_init(buf, count, datatype, dest, tag, comm, request, ierror) 14
                                                                15 ticket229.2.
                                                                16 ticket-248T.
        BIND(C)
        TYPE(*), DIMENSION(..), INTENT(IN), ASYNCHRONOUS :: buf 17
        INTEGER, INTENT(IN) :: count, dest, tag 18
        TYPE(MPI_Datatype), INTENT(IN) :: datatype 19
        TYPE(MPI_Comm), INTENT(IN) :: comm 20
        TYPE(MPI_Request), INTENT(OUT) :: request 21
        INTEGER, OPTIONAL, INTENT(OUT) :: ierror 22
                                                                23
MPI_SEND_INIT(BUF, COUNT, DATATYPE, DEST, TAG, COMM, REQUEST, IERROR) 24
    <type> BUF(*) 25
    INTEGER [REQUEST, ]COUNT, DATATYPE, DEST, TAG, COMM, REQUEST, IERROR 26
                                                                27 ticket250-V.
{MPI::Prequest MPI::Comm::Send_init(const void* buf, int count, const 28
    MPI::Datatype& datatype, int dest, int tag) const(binding 29
    deprecated, see Section 15.2) } 30
                                                                31
    Creates a persistent communication request for a standard mode send operation, and 32
    binds to it all the arguments of a send operation. 33
                                                                34
MPI_BSEND_INIT(buf, count, datatype, dest, tag, comm, request) 35
    IN      buf          initial address of send buffer (choice) 36
    IN      count        number of elements sent (non-negative integer) 37
    IN      datatype     type of each element (handle) 38
    IN      dest         rank of destination (integer) 39
    IN      tag          message tag (integer) 40
    IN      comm         communicator (handle) 41
    OUT     request      communication request (handle) 42
                                                                43
                                                                44
int MPI_Bsend_init(const void* buf, int count, MPI_Datatype datatype, 45
                  int dest, int tag, MPI_Comm comm, MPI_Request *request) 46
                                                                47 ticket140.
                                                                48 ticket229.2.
                                                                ticket-248T.

```

```

1 MPI_Bsend_init(buf, count, datatype, dest, tag, comm, request, ierror)
2     BIND(C)
3     TYPE(*), DIMENSION(..), INTENT(IN), ASYNCHRONOUS :: buf
4     INTEGER, INTENT(IN) :: count, dest, tag
5     TYPE(MPI_Datatype), INTENT(IN) :: datatype
6     TYPE(MPI_Comm), INTENT(IN) :: comm
7     TYPE(MPI_Request), INTENT(OUT) :: request
8     INTEGER, OPTIONAL, INTENT(OUT) :: ierror

```

```

9 MPI_BSEND_INIT(BUF, COUNT, DATATYPE, DEST, TAG, COMM, REQUEST, IERROR)
10 <type> BUF(*)
11 INTEGER [REQUEST, ]COUNT, DATATYPE, DEST, TAG, COMM, REQUEST, IERROR

```

```

12 {MPI::Prequest MPI::Comm::Bsend_init(const void* buf, int count, const
13     MPI::Datatype& datatype, int dest, int tag) const(binding
14     deprecated, see Section 15.2) }

```

Creates a persistent communication request for a buffered mode send.

```

19 MPI_SSEND_INIT(buf, count, datatype, dest, tag, comm, request)

```

21	IN	buf	initial address of send buffer (choice)
22	IN	count	number of elements sent (non-negative integer)
23	IN	datatype	type of each element (handle)
24	IN	dest	rank of destination (integer)
25	IN	tag	message tag (integer)
26	IN	comm	communicator (handle)
27	IN	request	communication request (handle)

```

30 int MPI_Ssend_init(const void* buf, int count, MPI_Datatype datatype,
31     int dest, int tag, MPI_Comm comm, MPI_Request *request)

```

```

32 MPI_Ssend_init(buf, count, datatype, dest, tag, comm, request, ierror)
33     BIND(C)
34     TYPE(*), DIMENSION(..), INTENT(IN), ASYNCHRONOUS :: buf
35     INTEGER, INTENT(IN) :: count, dest, tag
36     TYPE(MPI_Datatype), INTENT(IN) :: datatype
37     TYPE(MPI_Comm), INTENT(IN) :: comm
38     TYPE(MPI_Request), INTENT(OUT) :: request
39     INTEGER, OPTIONAL, INTENT(OUT) :: ierror

```

```

40 MPI_SSEND_INIT(BUF, COUNT, DATATYPE, DEST, TAG, COMM, REQUEST, IERROR)
41 <type> BUF(*)
42 INTEGER COUNT, DATATYPE, DEST, TAG, COMM, REQUEST, IERROR

```

```

43 {MPI::Prequest MPI::Comm::Ssend_init(const void* buf, int count, const
44     MPI::Datatype& datatype, int dest, int tag) const(binding
45     deprecated, see Section 15.2) }

```

Creates a persistent communication object for a synchronous mode send operation.

MPI_RSEND_INIT(buf, count, datatype, dest, tag, comm, request)

IN	buf	initial address of send buffer (choice)
IN	count	number of elements sent (non-negative integer)
IN	datatype	type of each element (handle)
IN	dest	rank of destination (integer)
IN	tag	message tag (integer)
IN	comm	communicator (handle)
OUT	request	communication request (handle)

```
int MPI_Rsend_init(const void* buf, int count, MPI_Datatype datatype,
                  int dest, int tag, MPI_Comm comm, MPI_Request *request)
```

```
MPI_Rsend_init(buf, count, datatype, dest, tag, comm, request, ierror)
```

```
    BIND(C)
```

```
    TYPE(*), DIMENSION(..), INTENT(IN), ASYNCHRONOUS :: buf
    INTEGER, INTENT(IN) :: count, dest, tag
    TYPE(MPI_Datatype), INTENT(IN) :: datatype
    TYPE(MPI_Comm), INTENT(IN) :: comm
    TYPE(MPI_Request), INTENT(OUT) :: request
    INTEGER, OPTIONAL, INTENT(OUT) :: ierror
```

```
MPI_RSEND_INIT(BUF, COUNT, DATATYPE, DEST, TAG, COMM, REQUEST, IERROR)
```

```
<type> BUF(*)
```

```
INTEGER COUNT, DATATYPE, DEST, TAG, COMM, REQUEST, IERROR
```

```
{MPI::Prequest MPI::Comm::Rsend_init(const void* buf, int count, const
    MPI::Datatype& datatype, int dest, int tag) const(binding
    deprecated, see Section 15.2) }
```

Creates a persistent communication object for a ready mode send operation.

MPI_RECV_INIT(buf, count, datatype, source, tag, comm, request)

OUT	buf	initial address of receive buffer (choice)
IN	count	number of elements received (non-negative integer)
IN	datatype	type of each element (handle)
IN	source	rank of source or MPI_ANY_SOURCE (integer)
IN	tag	message tag or MPI_ANY_TAG (integer)
IN	comm	communicator (handle)
OUT	request	communication request (handle)

```

1 int MPI_Recv_init(void* buf, int count, MPI_Datatype datatype, int source,
2                   int tag, MPI_Comm comm, MPI_Request *request)

```

```

3 MPI_Recv_init(buf, count, datatype, source, tag, comm, request, ierror)
4 BIND(C)

```

```

5     TYPE(*), DIMENSION(..), ASYNCHRONOUS :: buf
6     INTEGER, INTENT(IN) :: count, source, tag
7     TYPE(MPI_Datatype), INTENT(IN) :: datatype
8     TYPE(MPI_Comm), INTENT(IN) :: comm
9     TYPE(MPI_Request), INTENT(OUT) :: request
10    INTEGER, OPTIONAL, INTENT(OUT) :: ierror

```

```

12 MPI_RECV_INIT(BUF, COUNT, DATATYPE, SOURCE, TAG, COMM, REQUEST, IERROR)
13 <type> BUF(*)
14 INTEGER COUNT, DATATYPE, SOURCE, TAG, COMM, REQUEST, IERROR

```

```

15 {MPI::Prequest MPI::Comm::Recv_init(void* buf, int count, const
16     MPI::Datatype& datatype, int source, int tag) const(binding
17     deprecated, see Section 15.2)}

```

Creates a persistent communication request for a receive operation. The argument `buf` is marked as OUT because the user gives permission to write on the receive buffer by passing the argument to `MPI_RECV_INIT`.

A persistent communication request is inactive after it was created — no active communication is attached to the request.

A communication (send or receive) that uses a persistent request is initiated by the function `MPI_START`.

```

28 MPI_START(request)

```

```

29     INOUT    request                communication request (handle)

```

```

31 int MPI_Start(MPI_Request *request)

```

```

32 MPI_Start(request, ierror) BIND(C)
33     TYPE(MPI_Request), INTENT(INOUT) :: request
34     INTEGER, OPTIONAL, INTENT(OUT) :: ierror

```

```

36 MPI_START(REQUEST, IERROR)
37     INTEGER REQUEST, IERROR

```

```

39 {void MPI::Prequest::Start()(binding deprecated, see Section 15.2)}

```

The argument, `request`, is a handle returned by one of the previous five calls. The associated request should be inactive. The request becomes active once the call is made.

If the request is for a send with ready mode, then a matching receive should be posted before the call is made. The communication buffer should not be modified after the call, and until the operation completes.

The call is local, with similar semantics to the nonblocking communication operations described in Section 3.7. That is, a call to `MPI_START` with a request created by `MPI_SEND_INIT` starts a communication in the same manner as a call to `MPI_ISEND`; a

call to `MPI_START` with a request created by `MPI_BSEND_INIT` starts a communication in the same manner as a call to `MPI_IBSEND`; and so on.

`MPI_STARTALL(count, array_of_requests)`

IN count list length (non-negative integer)
 INOUT array_of_requests array of requests (array of handle)

```
int MPI_Startall(int count, MPI_Request [*]array_of_requests [])
```

```
MPI_Startall(count, array_of_requests, ierror) BIND(C)
  INTEGER, INTENT(IN) :: count
  TYPE(MPI_Request), INTENT(INOUT) :: array_of_requests(count)
  INTEGER, OPTIONAL, INTENT(OUT) :: ierror
```

```
MPI_STARTALL(COUNT, ARRAY_OF_REQUESTS, IERROR)
  INTEGER COUNT, ARRAY_OF_REQUESTS(*), IERROR
```

```
{static void MPI::Prequest::Startall(int count,
  MPI::Prequest array_of_requests []) (binding deprecated, see
  Section 15.2) }
```

Start all communications associated with requests in `array_of_requests`. A call to `MPI_STARTALL(count, array_of_requests)` has the same effect as calls to `MPI_START (&array_of_requests[i])`, executed for `i=0 ... count-1`, in some arbitrary order.

A communication started with a call to `MPI_START` or `MPI_STARTALL` is completed by a call to `MPI_WAIT`, `MPI_TEST`, or one of the derived functions described in Section 3.7.5. The request becomes inactive after successful completion of such call. The request is not deallocated and it can be activated anew by an `MPI_START` or `MPI_STARTALL` call.

A persistent request is deallocated by a call to `MPI_REQUEST_FREE` (Section 3.7.3).

The call to `MPI_REQUEST_FREE` can occur at any point in the program after the persistent request was created. However, the request will be deallocated only after it becomes inactive. Active receive requests should not be freed. Otherwise, it will not be possible to check that the receive has completed. It is preferable, in general, to free requests when they are inactive. If this rule is followed, then the functions described in this section will be invoked in a sequence of the form,

Create (Start Complete)* Free

where `*` indicates zero or more repetitions. If the same communication object is used in several concurrent threads, it is the user's responsibility to coordinate calls so that the correct sequence is obeyed.

A send operation initiated with `MPI_START` can be matched with any receive operation and, likewise, a receive operation initiated with `MPI_START` can receive messages generated by any send operation.

Advice to users. To prevent problems with the argument copying and register optimization done by Fortran compilers, please note the hints in [subsections "Problems](#)

Due to Data Copying and Sequence Association,” and “A Problem with Register Optimization and Temporary Memory Modifications” in Section 16.2.10 on pages 675 and 681.]Sections 16.2.10-16.2.20, especially in Sections 16.2.12 and 16.2.13 on pages 675-678 about “Problems Due to Data Copying and Sequence Association with Subscript Triplets” and “Vector Subscripts”, and in Sections 16.2.16 to 16.2.19 on pages 681 to 692 about “Optimization Problems”, “Code Movements and Register Optimization”, “Temporary Data Movements” and “Permanent Data Movements”. (*End of advice to users.*)

3.10 Send-Receive

The **send-receive** operations combine in one call the sending of a message to one destination and the receiving of another message, from another process. The two (source and destination) are possibly the same. A send-receive operation is very useful for executing a shift operation across a chain of processes. If blocking sends and receives are used for such a shift, then one needs to order the sends and receives correctly (for example, even processes send, then receive, odd processes receive first, then send) so as to prevent cyclic dependencies that may lead to deadlock. When a send-receive operation is used, the communication subsystem takes care of these issues. The send-receive operation can be used in conjunction with the functions described in Chapter 7 in order to perform shifts on various logical topologies. Also, a send-receive operation is useful for implementing remote procedure calls.

A message sent by a send-receive operation can be received by a regular receive operation or probed by a probe operation; a send-receive operation can receive a message sent by a regular send operation.

`MPI_SENDRECV(sendbuf, sendcount, sendtype, dest, sendtag, recvbuf, recvcount, recvtype, source, recvtag, comm, status)`

IN	sendbuf	initial address of send buffer (choice)
IN	sendcount	number of elements in send buffer (non-negative integer)
IN	sendtype	type of elements in send buffer (handle)
IN	dest	rank of destination (integer)
IN	sendtag	send tag (integer)
OUT	recvbuf	initial address of receive buffer (choice)
IN	recvcount	number of elements in receive buffer (non-negative integer)
IN	recvtype	type of elements in receive buffer (handle)
IN	source	rank of source or MPI_ANY_SOURCE (integer)
IN	recvtag	receive tag or MPI_ANY_TAG (integer)
IN	comm	communicator (handle)
OUT	status	status object (Status)

```

int MPI_Sendrecv(const void *sendbuf, int sendcount, MPI_Datatype sendtype,
                int dest, int sendtag, void *recvbuf, int recvcount,
                MPI_Datatype recvtype, int source, int recvtag, MPI_Comm comm,
                MPI_Status *status)
MPI_Sendrecv(sendbuf, sendcount, sendtype, dest, sendtag, recvbuf,
             recvcount, recvtype, source, recvtag, comm, status, ierror)
BIND(C)
TYPE(*), DIMENSION(..), INTENT(IN) :: sendbuf
TYPE(*), DIMENSION(..) :: recvbuf
INTEGER, INTENT(IN) :: sendcount, dest, sendtag, recvcount, source,
recvtag
TYPE(MPI_Datatype), INTENT(IN) :: sendtype, recvtype
TYPE(MPI_Comm), INTENT(IN) :: comm
TYPE(MPI_Status) :: status
INTEGER, OPTIONAL, INTENT(OUT) :: ierror
MPI_SENDRFCV(SENDBUF, SENDCOUNT, SENDTYPE, DEST, SENDTAG, RECVBUF,
             RECVCOUNT, RECVTYPE, SOURCE, RECVTAG, COMM, STATUS, IERROR)
<type> SENDBUF(*), RECVBUF(*)
INTEGER SENDCOUNT, SENDTYPE, DEST, SENDTAG, RECVCOUNT, RECVTYPE,
SOURCE, RECVTAG, COMM, STATUS(MPI_STATUS_SIZE), IERROR
{void MPI::Comm::Sendrecv(const void *sendbuf, int sendcount, const
                        MPI::Datatype& sendtype, int dest, int sendtag, void *recvbuf,
                        int recvcount, const MPI::Datatype& recvtype, int source,
                        int recvtag, MPI::Status& status) const(binding deprecated, see
                        Section 15.2) }
{void MPI::Comm::Sendrecv(const void *sendbuf, int sendcount, const
                        MPI::Datatype& sendtype, int dest, int sendtag, void *recvbuf,
                        int recvcount, const MPI::Datatype& recvtype, int source,
                        int recvtag) const(binding deprecated, see Section 15.2) }

```

Execute a blocking send and receive operation. Both send and receive use the same communicator, but possibly different tags. The send buffer and receive buffers must be disjoint, and may have different lengths and datatypes.

The semantics of a send-receive operation is what would be obtained if the caller forked two concurrent threads, one to execute the send, and one to execute the receive, followed by a join of these two threads.

1	MPI_SENDRECV_REPLACE(buf, count, datatype, dest, sendtag, source, recvtag, status)		
2			
3	INOUT	buf	initial address of send and receive buffer (choice)
4			
5	IN	count	number of elements in send and receive buffer (non-negative integer)
6			
7	IN	datatype	type of elements in send and receive buffer (handle)
8			
9	IN	dest	rank of destination (integer)
10	IN	sendtag	send message tag (integer)
11	IN	source	rank of source or MPI_ANY_SOURCE (integer)
12	IN	recvtag	receive message tag or MPI_ANY_TAG (integer)
13			
14	IN	comm	communicator (handle)
15	OUT	status	status object (Status)
16			

```

17 int MPI_Sendrecv_replace(void* buf, int count, MPI_Datatype datatype,
18                          int dest, int sendtag, int source, int recvtag, MPI_Comm comm,
19                          MPI_Status *status)

```

```

20
21 MPI_Sendrecv_replace(buf, count, datatype, dest, sendtag, source, recvtag,
22                      comm, status, ierror) BIND(C)
23     TYPE(*), DIMENSION(..) :: buf
24     INTEGER, INTENT(IN) :: count, dest, sendtag, source, recvtag
25     TYPE(MPI_Datatype), INTENT(IN) :: datatype
26     TYPE(MPI_Comm), INTENT(IN) :: comm
27     TYPE(MPI_Status) :: status
28     INTEGER, OPTIONAL, INTENT(OUT) :: ierror

```

```

29 MPI_SENDRECV_REPLACE(BUF, COUNT, DATATYPE, DEST, SENDTAG, SOURCE, RECVTAG,
30                     COMM, STATUS, IERROR)
31     <type> BUF(*)
32     INTEGER COUNT, DATATYPE, DEST, SENDTAG, SOURCE, RECVTAG, COMM,
33     STATUS(MPI_STATUS_SIZE), IERROR

```

```

34
35 {void MPI::Comm::Sendrecv_replace(void* buf, int count, const
36     MPI::Datatype& datatype, int dest, int sendtag, int source,
37     int recvtag, MPI::Status& status) const(binding deprecated, see
38     Section 15.2) }

```

```

39 {void MPI::Comm::Sendrecv_replace(void* buf, int count, const
40     MPI::Datatype& datatype, int dest, int sendtag, int source,
41     int recvtag) const(binding deprecated, see Section 15.2) }
42

```

Execute a blocking send and receive. The same buffer is used both for the send and for the receive, so that the message sent is replaced by the message received.

Advice to implementors. Additional intermediate buffering is needed for the “replace” variant. (*End of advice to implementors.*)

3.11 Null Processes

In many instances, it is convenient to specify a “dummy” source or destination for communication. This simplifies the code that is needed for dealing with boundaries, for example, in the case of a non-circular shift done with calls to send-receive.

The special value `MPI_PROC_NULL` can be used instead of a rank wherever a source or a destination argument is required in a call. A communication with process `MPI_PROC_NULL` has no effect. A send to `MPI_PROC_NULL` succeeds and returns as soon as possible. A receive from `MPI_PROC_NULL` succeeds and returns as soon as possible with no modifications to the receive buffer. When a receive with `source = MPI_PROC_NULL` is executed then the status object returns `source = MPI_PROC_NULL`, `tag = MPI_ANY_TAG` and `count = 0`. A matching probe (cf. Section 3.8.2) with `MPI_PROC_NULL` as source returns `flag = true`, `message = MPI_MESSAGE_NULL`, and the status object returns `source = MPI_PROC_NULL`, `tag = MPI_ANY_TAG`, and `count = 0`.

1
2
3
4
5
6
7
8
9
10
11
12
13
14
15
16
17
18
19
20
21
22
23
24
25
26
27
28
29
30
31
32
33
34
35
36
37
38
39
40
41
42
43
44
45
46
47
48

ticket38.

1
2
3
4
5
6
7
8
9
10
11
12
13
14
15
16
17
18
19
20
21
22
23
24
25
26
27
28
29
30
31
32
33
34
35
36
37
38
39
40
41
42
43
44
45
46
47
48

1
2
3
4
5
6
7
8
9
10
11
12
13
14
15
16
17
18
19
20
21
22
23
24
25
26
27
28
29
30
31
32
33
34
35
36
37
38
39
40
41
42
43
44
45
46
47
48

Chapter 4

Datatypes

Basic datatypes were introduced in Section 3.2.2 Message Data on page 29 and in Section 3.3 Data Type Matching and Data Conversion on page 37. In this chapter, this model is extended to describe any data layout. We consider general datatypes that allow one to transfer efficiently heterogeneous and noncontiguous data. We conclude with the description of calls for explicit packing and unpacking of messages.

4.1 Derived Datatypes

Up to here, all point to point communication have involved only buffers containing a sequence of identical basic datatypes. This is too constraining on two accounts. One often wants to pass messages that contain values with different datatypes (e.g., an integer count, followed by a sequence of real numbers); and one often wants to send noncontiguous data (e.g., a sub-block of a matrix). One solution is to pack noncontiguous data into a contiguous buffer at the sender site and unpack it at the receiver site. This has the disadvantage of requiring additional memory-to-memory copy operations at both sites, even when the communication subsystem has scatter-gather capabilities. Instead, MPI provides mechanisms to specify more general, mixed, and noncontiguous communication buffers. It is up to the implementation to decide whether data should be first packed in a contiguous buffer before being transmitted, or whether it can be collected directly from where it resides.

The general mechanisms provided here allow one to transfer directly, without copying, objects of various shape and size. It is not assumed that the MPI library is cognizant of the objects declared in the host language. Thus, if one wants to transfer a structure, or an array section, it will be necessary to provide in MPI a definition of a communication buffer that mimics the definition of the structure or array section in question. These facilities can be used by library designers to define communication functions that can transfer objects defined in the host language — by decoding their definitions as available in a symbol table or a dope vector. Such higher-level communication functions are not part of MPI.

More general communication buffers are specified by replacing the basic datatypes that have been used so far with derived datatypes that are constructed from basic datatypes using the constructors described in this section. These methods of constructing derived datatypes can be applied recursively.

A **general datatype** is an opaque object that specifies two things:

- A sequence of basic datatypes

- A sequence of integer (byte) displacements

The displacements are not required to be positive, distinct, or in increasing order. Therefore, the order of items need not coincide with their order in store, and an item may appear more than once. We call such a pair of sequences (or sequence of pairs) a **type map**. The sequence of basic datatypes (displacements ignored) is the **type signature** of the datatype.

Let

$$Typemap = \{(type_0, disp_0), \dots, (type_{n-1}, disp_{n-1})\},$$

be such a type map, where $type_i$ are basic types, and $disp_i$ are displacements. Let

$$Typesig = \{type_0, \dots, type_{n-1}\}$$

be the associated type signature. This type map, together with a base address buf , specifies a communication buffer: the communication buffer that consists of n entries, where the i -th entry is at address $buf + disp_i$ and has type $type_i$. A message assembled from such a communication buffer will consist of n values, of the types defined by $Typesig$.

Most datatype constructors have replication count or block length arguments. Allowed values are non-negative integers. If the value is zero, no elements are generated in the type map and there is no effect on datatype bounds or extent.

We can use a handle to a general datatype as an argument in a send or receive operation, instead of a basic datatype argument. The operation `MPI_SEND(buf, 1, datatype, ...)` will use the send buffer defined by the base address `buf` and the general datatype associated with `datatype`; it will generate a message with the type signature determined by the `datatype` argument. `MPI_RECV(buf, 1, datatype, ...)` will use the receive buffer defined by the base address `buf` and the general datatype associated with `datatype`.

General datatypes can be used in all send and receive operations. We discuss, in Section 4.1.11, the case where the second argument `count` has value > 1 .

The basic datatypes presented in Section 3.2.2 are particular cases of a general datatype, and are predefined. Thus, `MPI_INT` is a predefined handle to a datatype with type map $\{(int, 0)\}$, with one entry of type `int` and displacement zero. The other basic datatypes are similar.

The **extent** of a datatype is defined to be the span from the first byte to the last byte occupied by entries in this datatype, rounded up to satisfy alignment requirements. That is, if

$$Typemap = \{(type_0, disp_0), \dots, (type_{n-1}, disp_{n-1})\},$$

then

$$\begin{aligned} lb(Typemap) &= \min_j disp_j, \\ ub(Typemap) &= \max_j (disp_j + sizeof(type_j)) + \epsilon, \text{ and} \\ extent(Typemap) &= ub(Typemap) - lb(Typemap). \end{aligned} \tag{4.1}$$

If $type_i$ requires alignment to a byte address that is a multiple of k_i , then ϵ is the least non-negative increment needed to round $extent(Typemap)$ to the next multiple of $\max_i k_i$.

In Fortran, whether the alignments k_i are computed according to the alignments used by the compiler in common blocks, SEQUENCE derived types, BIND(C) derived types, or derived

types that are neither `SEQUENCE` nor `BIND(C)`, is implementation-dependent. The complete definition of `extent` is given [on page 113]in Section 4.1.6 on page 112.

Example 4.1 Assume that $Type = \{(double, 0), (char, 8)\}$ (a double at displacement zero, followed by a char at displacement eight). Assume, furthermore, that doubles have to be strictly aligned at addresses that are multiples of eight. Then, the extent of this datatype is 16 (9 rounded to the next multiple of 8). A datatype that consists of a character immediately followed by a double will also have an extent of 16.

Rationale. The definition of extent is motivated by the assumption that the amount of padding added at the end of each structure in an array of structures is the least needed to fulfill alignment constraints. More explicit control of the extent is provided in Section 4.1.6. Such explicit control is needed in cases where the assumption does not hold, for example, where union types are used. In Fortran, structures can be expressed with several language features, e.g., common blocks, `SEQUENCE` derived types, or `BIND(C)` derived types. The compiler may use different alignments, and therefore, it is recommended to use `MPI_TYPE_CREATE_RESIZED` for arrays of structures if an alignment may cause an alignment-gap at the end of a structure as described in Section 4.1.6 on page 112 and in Section 16.2.15 on page 679. (*End of rationale.*)

4.1.1 Type Constructors with Explicit Addresses

In Fortran, the functions `MPI_TYPE_CREATE_HVECTOR`, `MPI_TYPE_CREATE_HINDEXED`, `MPI_TYPE_CREATE_HINDEXED_BLOCK`, `MPI_TYPE_CREATE_STRUCT`, and `MPI_GET_ADDRESS` accept arguments of type `INTEGER(KIND=MPI_ADDRESS_KIND)`, where arguments of type `MPI_Aint` and `MPI::Aint` are used in C and C++. On Fortran 77 systems that do not support the Fortran 90 `KIND` notation, and where addresses are 64 bits whereas default `INTEGER`s are 32 bits, these arguments will be of type `INTEGER*8`.

4.1.2 Datatype Constructors

Contiguous The simplest datatype constructor is `MPI_TYPE_CONTIGUOUS` which allows replication of a datatype into contiguous locations.

```
MPI_TYPE_CONTIGUOUS(count, oldtype, newtype)
```

IN	count	replication count (non-negative integer)
IN	oldtype	old datatype (handle)
OUT	newtype	new datatype (handle)

```
int MPI_Type_contiguous(int count, MPI_Datatype oldtype,
                        MPI_Datatype *newtype)
```

```
MPI_Type_contiguous(count, oldtype, newtype, ierror) BIND(C)
  INTEGER, INTENT(IN) :: count
  TYPE(MPI_Datatype), INTENT(IN) :: oldtype
  TYPE(MPI_Datatype), INTENT(OUT) :: newtype
  INTEGER, OPTIONAL, INTENT(OUT) :: ierror
```

```

1 MPI_TYPE_CONTIGUOUS(COUNT, OLDTYPE, NEWTYPE, IERROR)
2     INTEGER COUNT, OLDTYPE, NEWTYPE, IERROR
3
4 {MPI::Datatype MPI::Datatype::Create_contiguous(int count) const(binding
5     deprecated, see Section 15.2) }
```

`newtype` is the datatype obtained by concatenating `count` copies of `oldtype`. Concatenation is defined using *extent* as the size of the concatenated copies.

Example 4.2 Let `oldtype` have type map $\{(double, 0), (char, 8)\}$, with extent 16, and let `count = 3`. The type map of the datatype returned by `newtype` is

$$\{(double, 0), (char, 8), (double, 16), (char, 24), (double, 32), (char, 40)\};$$

i.e., alternating `double` and `char` elements, with displacements 0, 8, 16, 24, 32, 40.

In general, assume that the type map of `oldtype` is

$$\{(type_0, disp_0), \dots, (type_{n-1}, disp_{n-1})\},$$

with extent ex . Then `newtype` has a type map with $count \cdot n$ entries defined by:

$$\{(type_0, disp_0), \dots, (type_{n-1}, disp_{n-1}), (type_0, disp_0 + ex), \dots, (type_{n-1}, disp_{n-1} + ex), \\ \dots, (type_0, disp_0 + ex \cdot (count - 1)), \dots, (type_{n-1}, disp_{n-1} + ex \cdot (count - 1))\}.$$

Vector The function `MPI_TYPE_VECTOR` is a more general constructor that allows replication of a datatype into locations that consist of equally spaced blocks. Each block is obtained by concatenating the same number of copies of the old datatype. The spacing between blocks is a multiple of the extent of the old datatype.

```

32 MPI_TYPE_VECTOR( count, blocklength, stride, oldtype, newtype)
```

34	IN	count	number of blocks (non-negative integer)
35	IN	blocklength	number of elements in each block (non-negative integer)
36			
37			
38	IN	stride	number of elements between start of each block (integer)
39			
40	IN	oldtype	old datatype (handle)
41	OUT	newtype	new datatype (handle)
42			

```

43
44 int MPI_Type_vector(int count, int blocklength, int stride,
45     MPI_Datatype oldtype, MPI_Datatype *newtype)
```

```

46 MPI_Type_vector(count, blocklength, stride, oldtype, newtype, ierror)
```

```

47     BIND(C)
```

```

48     INTEGER, INTENT(IN) :: count, blocklength, stride
```

```

TYPE(MPI_Datatype), INTENT(IN) :: oldtype
TYPE(MPI_Datatype), INTENT(OUT) :: newtype
INTEGER, OPTIONAL, INTENT(OUT) :: ierror

MPI_TYPE_VECTOR(COUNT, BLOCKLENGTH, STRIDE, OLDTYPE, NEWTYPE, IERROR)
    INTEGER COUNT, BLOCKLENGTH, STRIDE, OLDTYPE, NEWTYPE, IERROR

{MPI::Datatype MPI::Datatype::Create_vector(int count, int blocklength,
    int stride) const(binding deprecated, see Section 15.2) }

```

Example 4.3 Assume, again, that `oldtype` has type map $\{(double, 0), (char, 8)\}$, with extent 16. A call to `MPI_TYPE_VECTOR(2, 3, 4, oldtype, newtype)` will create the datatype with type map,

$$\{(double, 0), (char, 8), (double, 16), (char, 24), (double, 32), (char, 40), \\ (double, 64), (char, 72), (double, 80), (char, 88), (double, 96), (char, 104)\}.$$

That is, two blocks with three copies each of the old type, with a stride of 4 elements ($4 \cdot 16$ bytes) between the blocks.

Example 4.4 A call to `MPI_TYPE_VECTOR(3, 1, -2, oldtype, newtype)` will create the datatype,

$$\{(double, 0), (char, 8), (double, -32), (char, -24), (double, -64), (char, -56)\}.$$

In general, assume that `oldtype` has type map,

$$\{(type_0, disp_0), \dots, (type_{n-1}, disp_{n-1})\},$$

with extent ex . Let bl be the blocklength. The newly created datatype has a type map with $count \cdot bl \cdot n$ entries:

$$\{(type_0, disp_0), \dots, (type_{n-1}, disp_{n-1}), \\ (type_0, disp_0 + ex), \dots, (type_{n-1}, disp_{n-1} + ex), \dots, \\ (type_0, disp_0 + (bl - 1) \cdot ex), \dots, (type_{n-1}, disp_{n-1} + (bl - 1) \cdot ex), \\ (type_0, disp_0 + stride \cdot ex), \dots, (type_{n-1}, disp_{n-1} + stride \cdot ex), \dots, \\ (type_0, disp_0 + (stride + bl - 1) \cdot ex), \dots, (type_{n-1}, disp_{n-1} + (stride + bl - 1) \cdot ex), \dots, \\ (type_0, disp_0 + stride \cdot (count - 1) \cdot ex), \dots, \\ (type_{n-1}, disp_{n-1} + stride \cdot (count - 1) \cdot ex), \dots, \\ (type_0, disp_0 + (stride \cdot (count - 1) + bl - 1) \cdot ex), \dots, \\ (type_{n-1}, disp_{n-1} + (stride \cdot (count - 1) + bl - 1) \cdot ex)\}.$$

A call to `MPI_TYPE_CONTIGUOUS(count, oldtype, newtype)` is equivalent to a call to `MPI_TYPE_VECTOR(count, 1, 1, oldtype, newtype)`, or to a call to `MPI_TYPE_VECTOR(1, count, n, oldtype, newtype)`, n arbitrary.

Hvector The function `MPI_TYPE_CREATE_HVECTOR` is identical to `MPI_TYPE_VECTOR`, except that `stride` is given in bytes, rather than in elements. The use for both types of vector constructors is illustrated in Section 4.1.14. (H stands for “heterogeneous”).

```

MPI_TYPE_CREATE_HVECTOR( count, blocklength, stride, oldtype, newtype)
    IN      count          number of blocks (non-negative integer)
    IN      blocklength    number of elements in each block (non-negative integer)
    IN      stride         number of bytes between start of each block (integer)
    IN      oldtype        old datatype (handle)
    OUT     newtype        new datatype (handle)

```

```

int MPI_Type_create_hvector(int count, int blocklength, MPI_Aint stride,
    MPI_Datatype oldtype, MPI_Datatype *newtype)

```

```

MPI_Type_create_hvector(count, blocklength, stride, oldtype, newtype,
    ierror) BIND(C)
    INTEGER, INTENT(IN) :: count, blocklength
    INTEGER(KIND=MPI_ADDRESS_KIND), INTENT(IN) :: stride
    TYPE(MPI_Datatype), INTENT(IN) :: oldtype
    TYPE(MPI_Datatype), INTENT(OUT) :: newtype
    INTEGER, OPTIONAL, INTENT(OUT) :: ierror

```

```

MPI_TYPE_CREATE_HVECTOR(COUNT, BLOCKLENGTH, STRIDE, OLDTYPE, NEWTYPE,
    IERROR)
    INTEGER COUNT, BLOCKLENGTH, OLDTYPE, NEWTYPE, IERROR
    INTEGER(KIND=MPI_ADDRESS_KIND) STRIDE

```

```

{MPI::Datatype MPI::Datatype::Create_hvector(int count, int blocklength,
    MPI::Aint stride) const(binding deprecated, see Section 15.2) }

```

This function replaces `MPI_TYPE_HVECTOR`, whose use is deprecated. See also Chapter 15.

Assume that `oldtype` has type map,

$$\{(type_0, disp_0), \dots, (type_{n-1}, disp_{n-1})\},$$

with extent ex . Let bl be the blocklength. The newly created datatype has a type map with $count \cdot bl \cdot n$ entries:

$$\begin{aligned} &\{(type_0, disp_0), \dots, (type_{n-1}, disp_{n-1}), \\ &(type_0, disp_0 + ex), \dots, (type_{n-1}, disp_{n-1} + ex), \dots, \\ &(type_0, disp_0 + (bl - 1) \cdot ex), \dots, (type_{n-1}, disp_{n-1} + (bl - 1) \cdot ex), \\ &(type_0, disp_0 + stride), \dots, (type_{n-1}, disp_{n-1} + stride), \dots, \end{aligned}$$

```

(type0, disp0 + stride + (bl - 1) · ex), ...,
(typen-1, dispn-1 + stride + (bl - 1) · ex), ...,
(type0, disp0 + stride · (count - 1)), ..., (typen-1, dispn-1 + stride · (count - 1)), ...,
(type0, disp0 + stride · (count - 1) + (bl - 1) · ex), ...,
(typen-1, dispn-1 + stride · (count - 1) + (bl - 1) · ex}).

```

Indexed The function `MPI_TYPE_INDEXED` allows replication of an old datatype into a sequence of blocks (each block is a concatenation of the old datatype), where each block can contain a different number of copies and have a different displacement. All block displacements are multiples of the old type extent.

```

MPI_TYPE_INDEXED( count, array_of_blocklengths, array_of_displacements, oldtype, new-
                type)

```

IN	count	number of blocks – also number of entries in array_of_displacements and array_of_blocklengths (non-negative integer)
IN	array_of_blocklengths	number of elements per block (array of non-negative integers)
IN	array_of_displacements	displacement for each block, in multiples of oldtype extent (array of integer)
IN	oldtype	old datatype (handle)
OUT	newtype	new datatype (handle)

```

int MPI_Type_indexed(int count, const int *array_of_blocklengths, const
                    int *array_of_displacements, MPI_Datatype oldtype,
                    MPI_Datatype *newtype)

```

```

MPI_Type_indexed(count, array_of_blocklengths, array_of_displacements,
                oldtype, newtype, ierror) BIND(C)
    INTEGER, INTENT(IN) :: count, array_of_blocklengths(count),
    array_of_displacements(count)
    TYPE(MPI_Datatype), INTENT(IN) :: oldtype
    TYPE(MPI_Datatype), INTENT(OUT) :: newtype
    INTEGER, OPTIONAL, INTENT(OUT) :: ierror

```

```

MPI_TYPE_INDEXED(COUNT, ARRAY_OF_BLOCKLENGTHS, ARRAY_OF_DISPLACEMENTS,
                OLDTYPE, NEWTYPE, IERROR)
    INTEGER COUNT, ARRAY_OF_BLOCKLENGTHS(*), ARRAY_OF_DISPLACEMENTS(*),
    OLDTYPE, NEWTYPE, IERROR

```

ticket140.
ticket140.
ticket-248T.

```

1 {MPI::Datatype MPI::Datatype::Create_indexed(int count,
2         const int array_of_blocklengths[],
3         const int array_of_displacements[]) const(binding deprecated, see
4         Section 15.2) }
```

Example 4.5

Let `oldtype` have type map $\{(double, 0), (char, 8)\}$, with extent 16. Let $B = (3, 1)$ and let $D = (4, 0)$. A call to `MPI_TYPE_INDEXED(2, B, D, oldtype, newtype)` returns a datatype with type map,

$$\{(double, 64), (char, 72), (double, 80), (char, 88), (double, 96), (char, 104), \\ (double, 0), (char, 8)\}.$$

That is, three copies of the old type starting at displacement 64, and one copy starting at displacement 0.

In general, assume that `oldtype` has type map,

$$\{(type_0, disp_0), \dots, (type_{n-1}, disp_{n-1})\},$$

with extent ex . Let B be the `array_of_blocklength` argument and D be the `array_of_displacements` argument. The newly created datatype has $n \cdot \sum_{i=0}^{count-1} B[i]$ entries:

$$\{(type_0, disp_0 + D[0] \cdot ex), \dots, (type_{n-1}, disp_{n-1} + D[0] \cdot ex), \dots, \\ (type_0, disp_0 + (D[0] + B[0] - 1) \cdot ex), \dots, (type_{n-1}, disp_{n-1} + (D[0] + B[0] - 1) \cdot ex), \dots, \\ (type_0, disp_0 + D[count-1] \cdot ex), \dots, (type_{n-1}, disp_{n-1} + D[count-1] \cdot ex), \dots, \\ (type_0, disp_0 + (D[count-1] + B[count-1] - 1) \cdot ex), \dots, \\ (type_{n-1}, disp_{n-1} + (D[count-1] + B[count-1] - 1) \cdot ex)\}.$$

A call to `MPI_TYPE_VECTOR(count, blocklength, stride, oldtype, newtype)` is equivalent to a call to `MPI_TYPE_INDEXED(count, B, D, oldtype, newtype)` where

$$D[j] = j \cdot stride, \quad j = 0, \dots, count - 1,$$

and

$$B[j] = blocklength, \quad j = 0, \dots, count - 1.$$

Hindexed The function `MPI_TYPE_CREATE_HINDEXED` is identical to `MPI_TYPE_INDEXED`, except that block displacements in `array_of_displacements` are specified in bytes, rather than in multiples of the `oldtype` extent.

`MPI_TYPE_CREATE_HINDEXED(count, array_of_blocklengths, array_of_displacements, oldtype, newtype)`

IN	count	number of blocks — also number of entries in <code>array_of_displacements</code> and <code>array_of_blocklengths</code> (non-negative integer)
IN	array_of_blocklengths	number of elements in each block (array of non-negative integers)
IN	array_of_displacements	byte displacement of each block (array of integer)
IN	oldtype	old datatype (handle)
OUT	newtype	new datatype (handle)

```
int MPI_Type_create_hindexed(int count, const int array_of_blocklengths[],
                             const MPI_Aint array_of_displacements[], MPI_Datatype oldtype,
                             MPI_Datatype *newtype)
```

```
MPI_Type_create_hindexed(count, array_of_blocklengths,
                          array_of_displacements, oldtype, newtype, ierror) BIND(C)
  INTEGER, INTENT(IN) :: count, array_of_blocklengths(count)
  INTEGER(KIND=MPI_ADDRESS_KIND), INTENT(IN) ::
  array_of_displacements(count)
  TYPE(MPI_Datatype), INTENT(IN) :: oldtype
  TYPE(MPI_Datatype), INTENT(OUT) :: newtype
  INTEGER, OPTIONAL, INTENT(OUT) :: ierror
```

```
MPI_TYPE_CREATE_HINDEXED(COUNT, ARRAY_OF_BLOCKLENGTHS,
                          ARRAY_OF_DISPLACEMENTS, OLDTYPE, NEWTYPE, IERROR)
  INTEGER COUNT, ARRAY_OF_BLOCKLENGTHS(*), OLDTYPE, NEWTYPE, IERROR
  INTEGER(KIND=MPI_ADDRESS_KIND) ARRAY_OF_DISPLACEMENTS(*)
```

```
{MPI::Datatype MPI::Datatype::Create_hindexed(int count,
        const int array_of_blocklengths[],
        const MPI::Aint array_of_displacements[]) const(binding
        deprecated, see Section 15.2) }
```

This function replaces `MPI_TYPE_HINDEXED`, whose use is deprecated. See also Chapter 15.

Assume that `oldtype` has type map,

$$\{(type_0, disp_0), \dots, (type_{n-1}, disp_{n-1})\},$$

with extent ex . Let `B` be the `array_of_blocklength` argument and `D` be the `array_of_displacements` argument. The newly created datatype has a type map with n .

1 $\sum_{i=0}^{\text{count}-1} B[i]$ entries:

2 $\{(type_0, disp_0 + D[0]), \dots, (type_{n-1}, disp_{n-1} + D[0]), \dots,$
 3 $(type_0, disp_0 + D[0] + (B[0] - 1) \cdot ex), \dots,$
 4 $(type_{n-1}, disp_{n-1} + D[0] + (B[0] - 1) \cdot ex), \dots,$
 5 $(type_0, disp_0 + D[\text{count}-1]), \dots, (type_{n-1}, disp_{n-1} + D[\text{count}-1]), \dots,$
 6 $(type_0, disp_0 + D[\text{count}-1] + (B[\text{count}-1] - 1) \cdot ex), \dots,$
 7 $(type_{n-1}, disp_{n-1} + D[\text{count}-1] + (B[\text{count}-1] - 1) \cdot ex)\}.$

16 **Indexed_block** This function is the same as `MPI_TYPE_INDEXED` except that the block-length is the same for all blocks. There are many codes using indirect addressing arising from unstructured grids where the blocksize is always 1 (gather/scatter). The following convenience function allows for constant blocksize and arbitrary displacements.

21 `MPI_TYPE_CREATE_INDEXED_BLOCK(count, blocklength, array_of_displacements, oldtype,`
 22 `newtype)`

24	IN	count	length of array of displacements (non-negative integer)
25	IN	blocklength	size of block (non-negative integer)
26	IN	array_of_displacements	array of displacements (array of integer)
27	IN	oldtype	old datatype (handle)
28	IN	oldtype	old datatype (handle)
29	OUT	newtype	new datatype (handle)

31 `int MPI_Type_create_indexed_block(int count, int blocklength, const`
 32 `int array_of_displacements[], MPI_Datatype oldtype,`
 33 `MPI_Datatype *newtype)`

34 `MPI_Type_create_indexed_block(count, blocklength, array_of_displacements,`
 35 `oldtype, newtype, ierror) BIND(C)`
 36 `INTEGER, INTENT(IN) :: count, blocklength,`
 37 `array_of_displacements(count)`
 38 `TYPE(MPI_Datatype), INTENT(IN) :: oldtype`
 39 `TYPE(MPI_Datatype), INTENT(OUT) :: newtype`
 40 `INTEGER, OPTIONAL, INTENT(OUT) :: ierror`

41 `MPI_TYPE_CREATE_INDEXED_BLOCK(COUNT, BLOCKLENGTH, ARRAY_OF_DISPLACEMENTS,`
 42 `OLDTYPE, NEWTYPE, IERROR)`
 43 `INTEGER COUNT, BLOCKLENGTH, ARRAY_OF_DISPLACEMENTS(*), OLDTYPE,`
 44 `NEWTYPE, IERROR`

45 `{MPI::Datatype MPI::Datatype::Create_indexed_block(int count,`
 46 `int blocklength,`

```
const int array_of_displacements[]) const(binding deprecated, see
Section 15.2) }
```

Hindexed_block The function `MPI_TYPE_CREATE_HINDEXED_BLOCK` is identical to `MPI_TYPE_CREATE_INDEXED_BLOCK`, except that block displacements in `array_of_displacements` are specified in bytes, rather than in multiples of the `oldtype` extent.

```
MPI_TYPE_CREATE_HINDEXED_BLOCK(count, blocklength, array_of_displacements, old-
type, newtype)
```

IN	count	length of array of displacements (non-negative integer)
IN	blocklength	size of block (non-negative integer)
IN	array_of_displacements	byte displacement of each block (array of integer)
IN	oldtype	old datatype (handle)
OUT	newtype	new datatype (handle)

```
int MPI_Type_create_hindexed_block(int count, int blocklength,
MPI_Aint array_of_displacements[], MPI_Datatype oldtype,
MPI_Datatype *newtype)
```

```
MPI_Type_create_hindexed_block(count, blocklength, array_of_displacements,
oldtype, newtype, ierror) BIND(C)
INTEGER, INTENT(IN) :: count, blocklength
INTEGER(KIND=MPI_Address_kind), INTENT(IN) ::
array_of_displacements(count)
TYPE(MPI_Datatype), INTENT(IN) :: oldtype
TYPE(MPI_Datatype), INTENT(OUT) :: newtype
INTEGER, OPTIONAL, INTENT(OUT) :: ierror
```

```
MPI_TYPE_CREATE_HINDEXED_BLOCK(COUNT, BLOCKLENGTH, ARRAY_OF_DISPLACEMENTS,
OLDTYPE, NEWTYPE, IERROR)
INTEGER COUNT, BLOCKLENGTH, OLDTYPE, NEWTYPE, IERROR
INTEGER(KIND=MPI_ADDRESS_KIND) ARRAY_OF_DISPLACEMENTS(*)
```

Struct `MPI_TYPE_STRUCT` is the most general type constructor. It further generalizes `MPI_TYPE_CREATE_HINDEXED` in that it allows each block to consist of replications of different datatypes.

```

1 MPI_TYPE_CREATE_STRUCT(count, array_of_blocklengths, array_of_displacements,
2     array_of_types, newtype)
3
4     IN     count           number of blocks (non-negative integer) — also num-
5                               ber of entries in arrays array_of_types,
6                               array_of_displacements and array_of_blocklengths
7
8     IN     array_of_blocklength number of elements in each block (array of non-negative
9                               integer)
10
11    IN     array_of_displacements byte displacement of each block (array of integer)
12
13    IN     array_of_types       type of elements in each block (array of handles to
14                               datatype objects)
15
16    OUT    newtype             new datatype (handle)

```

```

ticket140. 15 int MPI_Type_create_struct(int count, const int array_of_blocklengths[],
ticket140. 16     const MPI_Aint array_of_displacements[], const
ticket140. 17     MPI_Datatype array_of_types[], MPI_Datatype *newtype)

```

```

ticket-248T. 18 MPI_Type_create_struct(count, array_of_blocklengths,
19     array_of_displacements, array_of_types, newtype, ierror)
20     BIND(C)
21     INTEGER, INTENT(IN) :: count, array_of_blocklengths(count)
22     INTEGER(KIND=MPI_ADDRESS_KIND), INTENT(IN) ::
23     array_of_displacements(count)
24     TYPE(MPI_Datatype), INTENT(IN) :: array_of_types(count)
25     TYPE(MPI_Datatype), INTENT(OUT) :: newtype
26     INTEGER, OPTIONAL, INTENT(OUT) :: ierror

```

```

28 MPI_TYPE_CREATE_STRUCT(COUNT, ARRAY_OF_BLOCKLENGTHS,
29     ARRAY_OF_DISPLACEMENTS, ARRAY_OF_TYPES, NEWTYPE, IERROR)
30     INTEGER COUNT, ARRAY_OF_BLOCKLENGTHS(*), ARRAY_OF_TYPES(*), NEWTYPE,
31     IERROR
32     INTEGER(KIND=MPI_ADDRESS_KIND) ARRAY_OF_DISPLACEMENTS(*)

```

```

33 {static MPI::Datatype MPI::Datatype::Create_struct(int count,
34     const int array_of_blocklengths[], const MPI::Aint
35     array_of_displacements[],
36     const MPI::Datatype array_of_types[]) (binding deprecated, see
37     Section 15.2) }

```

This function replaces MPI_TYPE_CREATE_STRUCT, whose use is deprecated. See also Chapter 15.

Example 4.6 Let type1 have type map,

```
{(double, 0), (char, 8)},
```

with extent 16. Let B = (2, 1, 3), D = (0, 16, 26), and T = (MPI_FLOAT, type1, MPI_CHAR). Then a call to MPI_TYPE_CREATE_STRUCT(3, B, D, T, newtype) returns a datatype with type map,

```
{(float, 0), (float, 4), (double, 16), (char, 24), (char, 26), (char, 27), (char, 28)}.
```

That is, two copies of MPI_FLOAT starting at 0, followed by one copy of type1 starting at 16, followed by three copies of MPI_CHAR, starting at 26. (We assume that a float occupies four bytes.)

In general, let T be the array_of_types argument, where T[i] is a handle to,

$$typemap_i = \{(type_0^i, disp_0^i), \dots, (type_{n_i-1}^i, disp_{n_i-1}^i)\},$$

with extent ex_i . Let B be the array_of_blocklength argument and D be the array_of_displacements argument. Let c be the count argument. Then the newly created datatype has a type map with $\sum_{i=0}^{c-1} B[i] \cdot n_i$ entries:

$$\begin{aligned} & \{(type_0^0, disp_0^0 + D[0]), \dots, (type_{n_0}^0, disp_{n_0}^0 + D[0]), \dots, \\ & (type_0^0, disp_0^0 + D[0] + (B[0] - 1) \cdot ex_0), \dots, (type_{n_0}^0, disp_{n_0}^0 + D[0] + (B[0]-1) \cdot ex_0), \dots, \\ & (type_0^{c-1}, disp_0^{c-1} + D[c-1]), \dots, (type_{n_{c-1}-1}^{c-1}, disp_{n_{c-1}-1}^{c-1} + D[c-1]), \dots, \\ & (type_0^{c-1}, disp_0^{c-1} + D[c-1] + (B[c-1] - 1) \cdot ex_{c-1}), \dots, \\ & (type_{n_{c-1}-1}^{c-1}, disp_{n_{c-1}-1}^{c-1} + D[c-1] + (B[c-1]-1) \cdot ex_{c-1})\}. \end{aligned}$$

A call to MPI_TYPE_CREATE_HINDEXED(count, B, D, oldtype, newtype) is equivalent to a call to MPI_TYPE_CREATE_STRUCT(count, B, D, T, newtype), where each entry of T is equal to oldtype.

4.1.3 Subarray Datatype Constructor

MPI_TYPE_CREATE_SUBARRAY(ndims, array_of_sizes, array_of_subsizes, array_of_starts, order, oldtype, newtype)

IN	ndims	number of array dimensions (positive integer)
IN	array_of_sizes	number of elements of type oldtype in each dimension of the full array (array of positive integers)
IN	array_of_subsizes	number of elements of type oldtype in each dimension of the subarray (array of positive integers)
IN	array_of_starts	starting coordinates of the subarray in each dimension (array of non-negative integers)
IN	order	array storage order flag (state)
IN	oldtype	array element datatype (handle)
OUT	newtype	new datatype (handle)

```
int MPI_Type_create_subarray(int ndims, const int array_of_sizes[], const
    int array_of_subsizes[], const int array_of_starts[], int
    order, MPI_Datatype oldtype, MPI_Datatype *newtype)
```

46 ticket140.
47 ticket140.
48 ticket140.

```

1 MPI_Type_create_subarray(ndims, array_of_sizes, array_of_subsizes,
2     array_of_starts, order, oldtype, newtype, ierror) BIND(C)
3     INTEGER, INTENT(IN) :: ndims, array_of_sizes(ndims),
4     array_of_subsizes(ndims), array_of_starts(ndims), order
5     TYPE(MPI_Datatype), INTENT(IN) :: oldtype
6     TYPE(MPI_Datatype), INTENT(OUT) :: newtype
7     INTEGER, OPTIONAL, INTENT(OUT) :: ierror
8
9 MPI_TYPE_CREATE_SUBARRAY(NDIMS, ARRAY_OF_SIZES, ARRAY_OF_SUBSIZES,
10     ARRAY_OF_STARTS, ORDER, OLDDTYPE, NEWTYPE, IERROR)
11     INTEGER NDIMS, ARRAY_OF_SIZES(*), ARRAY_OF_SUBSIZES(*),
12     ARRAY_OF_STARTS(*), ORDER, OLDDTYPE, NEWTYPE, IERROR
13
14 {MPI::Datatype MPI::Datatype::Create_subarray(int ndims,
15     const int array_of_sizes[], const int array_of_subsizes[],
16     const int array_of_starts[], int order) const(binding deprecated,
17     see Section 15.2) }

```

The subarray type constructor creates an MPI datatype describing an n -dimensional subarray of an n -dimensional array. The subarray may be situated anywhere within the full array, and may be of any nonzero size up to the size of the larger array as long as it is confined within this array. This type constructor facilitates creating filetypes to access arrays distributed in blocks among processes to a single file that contains the global array, see MPI I/O, especially Section 13.1.1 on page 513.

This type constructor can handle arrays with an arbitrary number of dimensions and works for both C and Fortran ordered matrices (i.e., row-major or column-major). Note that a C program may use Fortran order and a Fortran program may use C order.

The `ndims` parameter specifies the number of dimensions in the full data array and gives the number of elements in `array_of_sizes`, `array_of_subsizes`, and `array_of_starts`.

The number of elements of type `oldtype` in each dimension of the n -dimensional array and the requested subarray are specified by `array_of_sizes` and `array_of_subsizes`, respectively. For any dimension i , it is erroneous to specify `array_of_subsizes[i] < 1` or `array_of_subsizes[i] > array_of_sizes[i]`.

The `array_of_starts` contains the starting coordinates of each dimension of the subarray. Arrays are assumed to be indexed starting from zero. For any dimension i , it is erroneous to specify `array_of_starts[i] < 0` or `array_of_starts[i] > (array_of_sizes[i] - array_of_subsizes[i])`.

Advice to users. In a Fortran program with arrays indexed starting from 1, if the starting coordinate of a particular dimension of the subarray is n , then the entry in `array_of_starts` for that dimension is $n-1$. (*End of advice to users.*)

The `order` argument specifies the storage order for the subarray as well as the full array. It must be set to one of the following:

MPI_ORDER_C The ordering used by C arrays, (i.e., row-major order)

MPI_ORDER_FORTRAN The ordering used by Fortran arrays, (i.e., column-major order)

A $ndims$ -dimensional subarray (`newtype`) with no extra padding can be defined by the function `Subarray()` as follows:

```
newtype = Subarray(ndims, {size0, size1, ..., sizendims-1},
```

$$\begin{aligned} & \{subsize_0, subsize_1, \dots, subsize_{ndims-1}\}, \\ & \{start_0, start_1, \dots, start_{ndims-1}\}, oldtype) \end{aligned}$$

Let the typemap of `oldtype` have the form:

$$\{(type_0, disp_0), (type_1, disp_1), \dots, (type_{n-1}, disp_{n-1})\}$$

where $type_i$ is a predefined MPI datatype, and let ex be the extent of `oldtype`. Then we define the `Subarray()` function recursively using the following three equations. Equation 4.2 defines the base step. Equation 4.3 defines the recursion step when `order = MPI_ORDER_FORTRAN`, and Equation 4.4 defines the recursion step when `order = MPI_ORDER_C`.

$$\begin{aligned} & \text{Subarray}(1, \{size_0\}, \{subsize_0\}, \{start_0\}, \\ & \quad \{(type_0, disp_0), (type_1, disp_1), \dots, (type_{n-1}, disp_{n-1})\}) \\ = & \{(MPI_LB, 0), \\ & (type_0, disp_0 + start_0 \times ex), \dots, (type_{n-1}, disp_{n-1} + start_0 \times ex), \\ & (type_0, disp_0 + (start_0 + 1) \times ex), \dots, (type_{n-1}, \\ & \quad disp_{n-1} + (start_0 + 1) \times ex), \dots \\ & (type_0, disp_0 + (start_0 + subsize_0 - 1) \times ex), \dots, \\ & \quad (type_{n-1}, disp_{n-1} + (start_0 + subsize_0 - 1) \times ex), \\ & (MPI_UB, size_0 \times ex)\} \end{aligned} \tag{4.2}$$

$$\begin{aligned} & \text{Subarray}(ndims, \{size_0, size_1, \dots, size_{ndims-1}\}, \\ & \quad \{subsize_0, subsize_1, \dots, subsize_{ndims-1}\}, \\ & \quad \{start_0, start_1, \dots, start_{ndims-1}\}, oldtype) \\ = & \text{Subarray}(ndims - 1, \{size_1, size_2, \dots, size_{ndims-1}\}, \\ & \quad \{subsize_1, subsize_2, \dots, subsize_{ndims-1}\}, \\ & \quad \{start_1, start_2, \dots, start_{ndims-1}\}, \\ & \quad \text{Subarray}(1, \{size_0\}, \{subsize_0\}, \{start_0\}, oldtype)) \end{aligned} \tag{4.3}$$

$$\begin{aligned} & \text{Subarray}(ndims, \{size_0, size_1, \dots, size_{ndims-1}\}, \\ & \quad \{subsize_0, subsize_1, \dots, subsize_{ndims-1}\}, \\ & \quad \{start_0, start_1, \dots, start_{ndims-1}\}, oldtype) \\ = & \text{Subarray}(ndims - 1, \{size_0, size_1, \dots, size_{ndims-2}\}, \\ & \quad \{subsize_0, subsize_1, \dots, subsize_{ndims-2}\}, \\ & \quad \{start_0, start_1, \dots, start_{ndims-2}\}, \\ & \quad \text{Subarray}(1, \{size_{ndims-1}\}, \{subsize_{ndims-1}\}, \{start_{ndims-1}\}, oldtype)) \end{aligned} \tag{4.4}$$

For an example use of `MPI_TYPE_CREATE_SUBARRAY` in the context of I/O see Section 13.9.2.

4.1.4 Distributed Array Datatype Constructor

The distributed array type constructor supports HPF-like [42] data distributions. However, unlike in HPF, the storage order may be specified for C arrays as well as for Fortran arrays.

Advice to users. One can create an HPF-like file view using this type constructor as follows. Complementary filetypes are created by having every process of a group call this constructor with identical arguments (with the exception of `rank` which should be set appropriately). These filetypes (along with identical `disp` and `etype`) are then used to define the view (via `MPI_FILE_SET_VIEW`), see MPI I/O, especially Section 13.1.1 on page 513 and Section 13.3 on page 526. Using this view, a collective data access operation (with identical offsets) will yield an HPF-like distribution pattern. (*End of advice to users.*)

```

11 MPI_TYPE_CREATE_DARRAY(size, rank, ndims, array_of_gsizes, array_of_distribs,
12                        array_of_dargs, array_of_psizes, order, oldtype, newtype)
13
14 IN      size                size of process group (positive integer)
15 IN      rank                rank in process group (non-negative integer)
16 IN      ndims               number of array dimensions as well as process grid
17                        dimensions (positive integer)
18
19 IN      array_of_gsizes     number of elements of type oldtype in each dimension
20                        of global array (array of positive integers)
21 IN      array_of_distribs   distribution of array in each dimension (array of state)
22 IN      array_of_dargs     distribution argument in each dimension (array of positive
23                        integers)
24
25 IN      array_of_psizes     size of process grid in each dimension (array of positive
26                        integers)
27 IN      order                array storage order flag (state)
28 IN      oldtype              old datatype (handle)
29 OUT     newtype              new datatype (handle)

```

```

ticket140. 32 int MPI_Type_create_darray(int size, int rank, int ndims, const
ticket140. 33     int array_of_gsizes[], const int array_of_distribs[], const
ticket140. 34     int array_of_dargs[], const int array_of_psizes[], int order,
ticket140. 35     MPI_Datatype oldtype, MPI_Datatype *newtype)

```

```

ticket-248T. 36 MPI_Type_create_darray(size, rank, ndims, array_of_gsizes,
37     array_of_distribs, array_of_dargs, array_of_psizes, order,
38     oldtype, newtype, ierror) BIND(C)
39     INTEGER, INTENT(IN) :: size, rank, ndims, array_of_gsizes(ndims),
40     array_of_distribs(ndims), array_of_dargs(ndims),
41     array_of_psizes(ndims), order
42     TYPE(MPI_Datatype), INTENT(IN) :: oldtype
43     TYPE(MPI_Datatype), INTENT(OUT) :: newtype
44     INTEGER, OPTIONAL, INTENT(OUT) :: ierror

```

```

46 MPI_TYPE_CREATE_DARRAY(SIZE, RANK, NDIMS, ARRAY_OF_GSIZES,
47     ARRAY_OF_DISTRIBS, ARRAY_OF_DARGS, ARRAY_OF_PSIZEs, ORDER,
48     OLDTYPE, NEWTYPE, IERROR)

```

```

INTEGER SIZE, RANK, NDIMS, ARRAY_OF_GSIZES(*), ARRAY_OF_DISTRIBS(*),
ARRAY_OF_DARGS(*), ARRAY_OF_PSIZEs(*), ORDER, OLDTYPE, NEWTYPE, IERROR
{MPI::Datatype MPI::Datatype::Create_darray(int size, int rank, int ndims,
      const int array_of_gsizes[], const int array_of_distribs[],
      const int array_of_dargs[], const int array_of_psize_s[],
      int order) const(binding deprecated, see Section 15.2) }

```

MPI_TYPE_CREATE_DARRAY can be used to generate the datatypes corresponding to the distribution of an `ndims`-dimensional array of `oldtype` elements onto an `ndims`-dimensional grid of logical processes. Unused dimensions of `array_of_psize_s` should be set to 1. (See Example 4.7, page 110.) For a call to MPI_TYPE_CREATE_DARRAY to be correct, the equation $\prod_{i=0}^{ndims-1} array_of_psize_s[i] = size$ must be satisfied. The ordering of processes in the process grid is assumed to be row-major, as in the case of virtual Cartesian process topologies .

Advice to users. For both Fortran and C arrays, the ordering of processes in the process grid is assumed to be row-major. This is consistent with the ordering used in virtual Cartesian process topologies in MPI. To create such virtual process topologies, or to find the coordinates of a process in the process grid, etc., users may use the corresponding process topology functions, see Chapter 7 on page 303. (*End of advice to users.*)

Each dimension of the array can be distributed in one of three ways:

- MPI_DISTRIBUTE_BLOCK - Block distribution
- MPI_DISTRIBUTE_CYCLIC - Cyclic distribution
- MPI_DISTRIBUTE_NONE - Dimension not distributed.

The constant MPI_DISTRIBUTE_DFLT_DARG specifies a default distribution argument. The distribution argument for a dimension that is not distributed is ignored. For any dimension `i` in which the distribution is MPI_DISTRIBUTE_BLOCK, it is erroneous to specify `array_of_dargs[i] * array_of_psize_s[i] < array_of_gsize_s[i]`.

For example, the HPF layout `ARRAY(CYCLIC(15))` corresponds to MPI_DISTRIBUTE_CYCLIC with a distribution argument of 15, and the HPF layout `ARRAY(BLOCK)` corresponds to MPI_DISTRIBUTE_BLOCK with a distribution argument of MPI_DISTRIBUTE_DFLT_DARG.

The `order` argument is used as in MPI_TYPE_CREATE_SUBARRAY to specify the storage order. Therefore, arrays described by this type constructor may be stored in Fortran (column-major) or C (row-major) order. Valid values for `order` are MPI_ORDER_FORTRAN and MPI_ORDER_C.

This routine creates a new MPI datatype with a typemap defined in terms of a function called “cyclic()” (see below).

Without loss of generality, it suffices to define the typemap for the MPI_DISTRIBUTE_CYCLIC case where MPI_DISTRIBUTE_DFLT_DARG is not used.

MPI_DISTRIBUTE_BLOCK and MPI_DISTRIBUTE_NONE can be reduced to the MPI_DISTRIBUTE_CYCLIC case for dimension `i` as follows.

MPI_DISTRIBUTE_BLOCK with `array_of_dargs[i]` equal to MPI_DISTRIBUTE_DFLT_DARG is equivalent to MPI_DISTRIBUTE_CYCLIC with `array_of_dargs[i]` set to

$$(array_of_gsizes[i] + array_of_psize_s[i] - 1) / array_of_psize_s[i].$$

1 If `array_of_dargs[i]` is not `MPI_DISTRIBUTE_DFLT_DARG`, then `MPI_DISTRIBUTE_BLOCK` and
 2 `MPI_DISTRIBUTE_CYCLIC` are equivalent.

3 `MPI_DISTRIBUTE_NONE` is equivalent to `MPI_DISTRIBUTE_CYCLIC` with
 4 `array_of_dargs[i]` set to `array_of_gsizes[i]`.

5 Finally, `MPI_DISTRIBUTE_CYCLIC` with `array_of_dargs[i]` equal to
 6 `MPI_DISTRIBUTE_DFLT_DARG` is equivalent to `MPI_DISTRIBUTE_CYCLIC` with
 7 `array_of_dargs[i]` set to 1.

8 For `MPI_ORDER_FORTRAN`, an `ndims`-dimensional distributed array (`newtype`) is defined
 9 by the following code fragment:

```
10
11     oldtype[0] = oldtype;
12     for ( i = 0; i < ndims; i++ ) {
13         oldtype[i+1] = cyclic(array_of_dargs[i],
14                             array_of_gsizes[i],
15                             r[i],
16                             array_of_psizes[i],
17                             oldtype[i]);
18     }
19     newtype = oldtype[ndims];
```

20
 21 For `MPI_ORDER_C`, the code is:

```
22
23     oldtype[0] = oldtype;
24     for ( i = 0; i < ndims; i++ ) {
25         oldtype[i + 1] = cyclic(array_of_dargs[ndims - i - 1],
26                             array_of_gsizes[ndims - i - 1],
27                             r[ndims - i - 1],
28                             array_of_psizes[ndims - i - 1],
29                             oldtype[i]);
30     }
31     newtype = oldtype[ndims];
```

32
 33 where $r[i]$ is the position of the process (with rank `rank`) in the process grid at dimension i .
 34 The values of $r[i]$ are given by the following code fragment:

```
35
36     t_rank = rank;
37     t_size = 1;
38     for ( i = 0; i < ndims; i++)
39         t_size *= array_of_psizes[i];
40     for ( i = 0; i < ndims; i++) {
41         t_size = t_size / array_of_psizes[i];
42         r[i] = t_rank / t_size;
43         t_rank = t_rank % t_size;
44     }
45
```

46 Let the typemap of `oldtype` have the form:

```
47     {(type0, disp0), (type1, disp1), ..., (typen-1, dispn-1)}
```

where $type_i$ is a predefined MPI datatype, and let ex be the extent of `oldtype`.

Given the above, the function `cyclic()` is defined as follows:

```

cyclic(darg, gsize, r, psize, oldtype)
= { (MPI_LB, 0),
    (type0, disp0 + r × darg × ex), ...,
    (typen-1, dispn-1 + r × darg × ex),
    (type0, disp0 + (r × darg + 1) × ex), ...,
    (typen-1, dispn-1 + (r × darg + 1) × ex),
    ...
    (type0, disp0 + ((r + 1) × darg - 1) × ex), ...,
    (typen-1, dispn-1 + ((r + 1) × darg - 1) × ex),
    ...
    (type0, disp0 + r × darg × ex + psize × darg × ex), ...,
    (typen-1, dispn-1 + r × darg × ex + psize × darg × ex),
    (type0, disp0 + (r × darg + 1) × ex + psize × darg × ex), ...,
    (typen-1, dispn-1 + (r × darg + 1) × ex + psize × darg × ex),
    ...
    (type0, disp0 + ((r + 1) × darg - 1) × ex + psize × darg × ex), ...,
    (typen-1, dispn-1 + ((r + 1) × darg - 1) × ex + psize × darg × ex),
    ⋮
    (type0, disp0 + r × darg × ex + psize × darg × ex × (count - 1)), ...,
    (typen-1, dispn-1 + r × darg × ex + psize × darg × ex × (count - 1)),
    (type0, disp0 + (r × darg + 1) × ex + psize × darg × ex × (count - 1)), ...,
    (typen-1, dispn-1 + (r × darg + 1) × ex
    + psize × darg × ex × (count - 1)),
    ...
    (type0, disp0 + (r × darg + darglast - 1) × ex
    + psize × darg × ex × (count - 1)), ...,
    (typen-1, dispn-1 + (r × darg + darglast - 1) × ex
    + psize × darg × ex × (count - 1)),
    (MPI_UB, gsize × ex) }

```

where *count* is defined by this code fragment:

```

nblocks = (gsize + (darg - 1)) / darg;
count = nblocks / psize;
left_over = nblocks - count * psize;
if (r < left_over)
    count = count + 1;

```

Here, *nblocks* is the number of blocks that must be distributed among the processors. Finally, *darg*_{*last*} is defined by this code fragment:

```

1      if ((num_in_last_cyclic = gsize % (psize * darg)) == 0)
2          darg_last = darg;
3      else
4          darg_last = num_in_last_cyclic - darg * r;
5          if (darg_last > darg)
6              darg_last = darg;
7          if (darg_last <= 0)
8              darg_last = darg;
9

```

Example 4.7 Consider generating the filetypes corresponding to the HPF distribution:

```

12      <oldtype> FILEARRAY(100, 200, 300)
13      !HPF$ PROCESSORS PROCESSES(2, 3)
14      !HPF$ DISTRIBUTE FILEARRAY(CYCLIC(10), *, BLOCK) ONTO PROCESSES
15

```

This can be achieved by the following Fortran code, assuming there will be six processes attached to the run:

```

18      ndims = 3
19      array_of_gsizes(1) = 100
20      array_of_distrib(1) = MPI_DISTRIBUTE_CYCLIC
21      array_of_dargs(1) = 10
22      array_of_gsizes(2) = 200
23      array_of_distrib(2) = MPI_DISTRIBUTE_NONE
24      array_of_dargs(2) = 0
25      array_of_gsizes(3) = 300
26      array_of_distrib(3) = MPI_DISTRIBUTE_BLOCK
27      array_of_dargs(3) = MPI_DISTRIBUTE_DFLT_DARG
28      array_of_psize(1) = 2
29      array_of_psize(2) = 1
30      array_of_psize(3) = 3
31      call MPI_COMM_SIZE(MPI_COMM_WORLD, size, ierr)
32      call MPI_COMM_RANK(MPI_COMM_WORLD, rank, ierr)
33      call MPI_TYPE_CREATE_DARRAY(size, rank, ndims, array_of_gsizes, &
34          array_of_distrib, array_of_dargs, array_of_psize, &
35          MPI_ORDER_FORTRAN, oldtype, newtype, ierr)
36

```

4.1.5 Address and Size Functions

The displacements in a general datatype are relative to some initial buffer address. **Absolute addresses** can be substituted for these displacements: we treat them as displacements relative to “address zero,” the start of the address space. This initial address zero is indicated by the constant `MPI_BOTTOM`. Thus, a datatype can specify the absolute address of the entries in the communication buffer, in which case the `buf` argument is passed the value `MPI_BOTTOM`.

The address of a location in memory can be found by invoking the function `MPI_GET_ADDRESS`.

```
MPI_GET_ADDRESS(location, address)
```

```
IN      location          location in caller memory (choice)
OUT     address           address of location (integer)
```

```
int MPI_Get_address(const void *location, MPI_Aint *address)
```

```
MPI_Get_address(location, address, ierror) BIND(C)
  TYPE(*), DIMENSION(..), ASYNCHRONOUS :: location
  INTEGER(KIND=MPI_ADDRESS_KIND), INTENT(OUT) :: address
  INTEGER, OPTIONAL, INTENT(OUT) :: ierror
```

```
MPI_GET_ADDRESS(LOCATION, ADDRESS, IERROR)
```

```
<type> LOCATION(*)
INTEGER IERROR
INTEGER(KIND=MPI_ADDRESS_KIND) ADDRESS
```

```
{MPI::Aint MPI::Get_address(void* location) (binding deprecated, see Section 15.2)
 }
```

This function replaces `MPI_ADDRESS`, whose use is deprecated. See also Chapter 15. Returns the (byte) address of location.

Advice to users. Current Fortran MPI codes will run unmodified, and will port to any system. However, they may fail if addresses larger than $2^{32} - 1$ are used in the program. New codes should be written so that they use the new functions. This provides compatibility with C/C++ and avoids errors on 64 bit architectures. However, such newly written codes may need to be (slightly) rewritten to port to old Fortran 77 environments that do not support `KIND` declarations. (*End of advice to users.*)

Rationale. In the `mpi_f08` module, the `location` argument is not defined with `INTENT(IN)` because existing applications may use `MPI_GET_ADDRESS` (and the deprecated `MPI_ADDRESS`) as a substitute for `MPI_F_SYNC_REG` that was not defined before MPI-3.0. (*End of rationale.*)

Example 4.8 Using `MPI_GET_ADDRESS` for an array.

```
REAL A(100,100)
INTEGER(KIND=MPI_ADDRESS_KIND) I1, I2, DIFF
CALL MPI_GET_ADDRESS(A(1,1), I1, IERROR)
CALL MPI_GET_ADDRESS(A(10,10), I2, IERROR)
DIFF = I2 - I1
! The value of DIFF is 909*sizeofreal; the values of I1 and I2 are
! implementation dependent.
```

Advice to users. C users may be tempted to avoid the usage of `MPI_GET_ADDRESS` and rely on the availability of the address operator `&`. Note, however, that `& cast-expression` is a pointer, not an address. ISO C does not require

that the value of a pointer (or the pointer cast to int) be the absolute address of the object pointed at — although this is commonly the case. Furthermore, referencing may not have a unique definition on machines with a segmented address space. The use of `MPI_GET_ADDRESS` to “reference” C variables guarantees portability to such machines as well. (*End of advice to users.*)

Advice to users. To prevent problems with the argument copying and register optimization done by Fortran compilers, please note the hints in [subsections “Problems Due to Data Copying and Sequence Association,” and “A Problem with Register Optimization” in Section 16.2.10 on pages 675 and 681.]Sections 16.2.10-16.2.20, especially in Sections 16.2.12 and 16.2.13 on pages 675-678 about “Problems Due to Data Copying and Sequence Association with Subscript Triplets” and “Vector Subscripts”, and in Sections 16.2.16 to 16.2.19 on pages 681 to 692 about “Optimization Problems”, “Code Movements and Register Optimization”, “Temporary Data Movements” and “Permanent Data Movements”. (*End of advice to users.*)

The following auxiliary function provides useful information on derived datatypes.

```
MPI_TYPE_SIZE(datatype, size)
```

```
IN      datatype          datatype (handle)
OUT     size              datatype size (integer)
```

```
int MPI_Type_size(MPI_Datatype datatype, int *size)
```

```
MPI_Type_size(datatype, size, ierror) BIND(C)
  TYPE(MPI_Datatype), INTENT(IN) :: datatype
  INTEGER, INTENT(OUT) :: size
  INTEGER, OPTIONAL, INTENT(OUT) :: ierror
```

```
MPI_TYPE_SIZE(DATATYPE, SIZE, IERROR)
  INTEGER DATATYPE, SIZE, IERROR
```

```
{int MPI::Datatype::Get_size() const(binding deprecated, see Section 15.2) }
```

`MPI_TYPE_SIZE` returns the total size, in bytes, of the entries in the type signature associated with `datatype`; i.e., the total size of the data in a message that would be created with this datatype. Entries that occur multiple times in the datatype are counted with their multiplicity.

For both functions, if the `OUT` parameter cannot express the value to be returned (e.g., if the parameter is too small to hold the output value), it is set to `MPI_UNDEFINED`.

4.1.6 Lower-Bound and Upper-Bound Markers

It is often convenient to define explicitly the lower bound and upper bound of a type map, and override the definition given on page 113. This allows one to define a datatype that has “holes” at its beginning or its end, or a datatype with entries that extend above the upper bound or below the lower bound. Examples of such usage are provided in Section 4.1.14. Also, the user may want to override the alignment rules that are used to compute upper bounds and extents. E.g., a C compiler may allow the user to override default alignment

rules for some of the structures within a program. The user has to specify explicitly the bounds of the datatypes that match these structures.

To achieve this, we add two additional “pseudo-datatypes,” `MPI_LB` and `MPI_UB`, that can be used, respectively, to mark the lower bound or the upper bound of a datatype. These pseudo-datatypes occupy no space ($extent(\text{MPI_LB}) = extent(\text{MPI_UB}) = 0$). They do not affect the size or count of a datatype, and do not affect the content of a message created with this datatype. However, they do affect the definition of the extent of a datatype and, therefore, affect the outcome of a replication of this datatype by a datatype constructor.

Example 4.9 Let $D = (-3, 0, 6)$; $T = (\text{MPI_LB}, \text{MPI_INT}, \text{MPI_UB})$, and $B = (1, 1, 1)$. Then a call to `MPI_TYPE_STRUCT(3, B, D, T, type1)` creates a new datatype that has an extent of 9 (from -3 to 5, 5 included), and contains an integer at displacement 0. This is the datatype defined by the sequence $\{(\text{lb}, -3), (\text{int}, 0), (\text{ub}, 6)\}$. If this type is replicated twice by a call to `MPI_TYPE_CONTIGUOUS(2, type1, type2)` then the newly created type can be described by the sequence $\{(\text{lb}, -3), (\text{int}, 0), (\text{int}, 9), (\text{ub}, 15)\}$. (An entry of type `ub` can be deleted if there is another entry of type `ub` with a higher displacement; an entry of type `lb` can be deleted if there is another entry of type `lb` with a lower displacement.)

In general, if

$$Typemap = \{(type_0, disp_0), \dots, (type_{n-1}, disp_{n-1})\},$$

then the **lower bound** of *Typemap* is defined to be

$$lb(Typemap) = \begin{cases} \min_j disp_j & \text{if no entry has basic type lb} \\ \min_j \{disp_j \text{ such that } type_j = \text{lb}\} & \text{otherwise} \end{cases}$$

Similarly, the **upper bound** of *Typemap* is defined to be

$$ub(Typemap) = \begin{cases} \max_j (disp_j + sizeof(type_j)) + \epsilon & \text{if no entry has basic type ub} \\ \max_j \{disp_j \text{ such that } type_j = \text{ub}\} & \text{otherwise} \end{cases}$$

Then

$$extent(Typemap) = ub(Typemap) - lb(Typemap)$$

If $type_i$ requires alignment to a byte address that is a multiple of k_i , then ϵ is the least non-negative increment needed to round $extent(Typemap)$ to the next multiple of $\max_i k_i$.

In Fortran, whether the alignments k_i are computed according to the alignments used by the compiler in common blocks, `SEQUENCE` derived types, `BIND(C)` derived types, or derived types that are neither `SEQUENCE` nor `BIND(C)`, is implementation-dependent.

The formal definitions given for the various datatype constructors apply now, with the amended definition of **extent**.

Rationale. Before Fortran 2003, `MPI_TYPE_CREATE_STRUCT` could be applied to Fortran common blocks and `SEQUENCE` derived types. With Fortran 2003, this list was extended by `BIND(C)` derived types and MPI implementors have implemented the alignments k_i differently, i.e., some based on the alignments used in `SEQUENCE` derived types, and others according to `BIND(C)` derived types. (*End of rationale.*)

Advice to implementors. In Fortran, it is generally recommended to use `BIND(C)` derived types instead of common blocks or `SEQUENCE` derived types. Therefore it is recommended to calculate the alignments k_i based on `BIND(C)` derived types. (*End of advice to implementors.*)

Advice to users. Structures combining different basic datatypes should be defined so that there will be no gaps based on alignment rules, and if used as an array of structures, then also without such an alignment-gap at the end of the structure. In MPI communication, the content of such gaps would not be communicated into the receiver's buffer. For example, such an alignment-gap may occur between an odd number of floats or REALs before a double or DOUBLE PRECISION data. Such gaps may be added explicitly to both the structure and the MPI derived datatype handle because the communication of a contiguous derived datatype may be significantly faster than the communication of one that is non-contiguous due to such alignment-gaps.

Example: Instead of

```

TYPE, BIND(C) :: my_data
  REAL, DIMENSION(3) :: x
  ! there may be a gap of the size of one REAL
  ! if the alignment of a DOUBLE PRECISION is
  ! two times the size of a REAL
  DOUBLE PRECISION: p
END TYPE

```

one should define

```

TYPE, BIND(C) :: my_data
  REAL, DIMENSION(3) :: x
  REAL :: gap1
  DOUBLE PRECISION: p
END TYPE

```

and also including `gap1` in the matching MPI derived datatype. It is required that all processes in a communication add the same gaps, i.e., defined with the same basic datatype. Both, the original and the modified structures are portable, but may have different performance implications for the communication and memory accesses during computation on systems with different alignment values.

In principle, a compiler may define an additional alignment rule for structures, e.g., to use at least 4 or 8 byte alignment although the content may have a $max_i k_i$ alignment less than this structure alignment. To keep an application portable, it is therefore recommended to always resize structure derived datatype handles if used in an array of structures, see the Example in Section 16.2.15 on page 679. (*End of advice to users.*)

4.1.7 Extent and Bounds of Datatypes

The following function replaces the three functions `MPI_TYPE_UB`, `MPI_TYPE_LB` and `MPI_TYPE_EXTENT` [*It also returns*] and also return address and count sized integers,

ticket265.
ticket265.
ticket265.

respectively, in the Fortran binding. The use of MPI_TYPE_UB, MPI_TYPE_LB and MPI_TYPE_EXTENT is deprecated.

MPI_TYPE_GET_EXTENT(datatype, lb, extent)

IN	datatype	datatype to get information on (handle)
OUT	lb	lower bound of datatype (integer)
OUT	extent	extent of datatype (integer)

```
int MPI_Type_get_extent(MPI_Datatype datatype, MPI_Aint *lb,
                       MPI_Aint *extent)
```

```
MPI_Type_get_extent(datatype, lb, extent, ierror) BIND(C)
  TYPE(MPI_Datatype), INTENT(IN) :: datatype
  INTEGER(KIND=MPI_ADDRESS_KIND), INTENT(OUT) :: lb, extent
  INTEGER, OPTIONAL, INTENT(OUT) :: ierror
```

```
MPI_TYPE_GET_EXTENT(DATATYPE, LB, EXTENT, IERROR)
  INTEGER DATATYPE, IERROR
  INTEGER(KIND = MPI_ADDRESS_KIND) LB, EXTENT
```

```
{void MPI::Datatype::Get_extent(MPI::Aint& lb, MPI::Aint& extent)
  const(binding deprecated, see Section 15.2) }
```

Returns the lower bound and the extent of datatype (as defined in Section 4.1.6 on page 112).

For both functions, if either OUT parameter cannot express the value to be returned (e.g., if the parameter is too small to hold the output value), it is set to MPI_UNDEFINED.

MPI allows one to change the extent of a datatype, using lower bound and upper bound markers (MPI_LB and MPI_UB). This is useful, as it allows to control the stride of successive datatypes that are replicated by datatype constructors, or are replicated by the count argument in a send or receive call. However, the current mechanism for achieving it is painful; also it is restrictive. MPI_LB and MPI_UB are “sticky”: once present in a datatype, they cannot be overridden (e.g., the upper bound can be moved up, by adding a new MPI_UB marker, but cannot be moved down below an existing MPI_UB marker). A new type constructor is provided to facilitate these changes. The use of MPI_LB and MPI_UB is deprecated.

MPI_TYPE_CREATE_RESIZED(oldtype, lb, extent, newtype)

IN	oldtype	input datatype (handle)
IN	lb	new lower bound of datatype (integer)
IN	extent	new extent of datatype (integer)
OUT	newtype	output datatype (handle)

```
int MPI_Type_create_resized(MPI_Datatype oldtype, MPI_Aint lb, MPI_Aint
                           extent, MPI_Datatype *newtype)
```

```

1 MPI_Type_create_resized(oldtype, lb, extent, newtype, ierror) BIND(C)
2   INTEGER(KIND=MPI_ADDRESS_KIND), INTENT(IN) :: lb, extent
3   TYPE(MPI_Datatype), INTENT(IN) :: oldtype
4   TYPE(MPI_Datatype), INTENT(OUT) :: newtype
5   INTEGER, OPTIONAL, INTENT(OUT) :: ierror
6
7 MPI_TYPE_CREATE_RESIZED(OLDTYPE, LB, EXTENT, NEWTYPE, IERROR)
8   INTEGER OLDTYPE, NEWTYPE, IERROR
9   INTEGER(KIND=MPI_ADDRESS_KIND) LB, EXTENT
10 {MPI::Datatype MPI::Datatype::Create_resized(const MPI::Aint lb,
11         const MPI::Aint extent) const(binding deprecated, see Section 15.2) }
12

```

Returns in `newtype` a handle to a new datatype that is identical to `oldtype`, except that the lower bound of this new datatype is set to be `lb`, and its upper bound is set to be `lb + extent`. Any previous `lb` and `ub` markers are erased, and a new pair of lower bound and upper bound markers are put in the positions indicated by the `lb` and `extent` arguments. This affects the behavior of the datatype when used in communication operations, with `count > 1`, and when used in the construction of new derived datatypes.

Advice to users. It is strongly recommended that users use these two new functions, rather than the old MPI-1 functions to set and access lower bound, upper bound and extent of datatypes. (*End of advice to users.*)

4.1.8 True Extent of Datatypes

Suppose we implement gather (see also Section 5.5 on page 160) as a spanning tree implemented on top of point-to-point routines. Since the receive buffer is only valid on the root process, one will need to allocate some temporary space for receiving data on intermediate nodes. However, the datatype extent cannot be used as an estimate of the amount of space that needs to be allocated, if the user has modified the extent using the `MPI_UB` and `MPI_LB` values. A function is provided which returns the true extent of the datatype.

```

32 MPI_TYPE_GET_TRUE_EXTENT(datatype, true_lb, true_extent)
33
34   IN      datatype          datatype to get information on (handle)
35   OUT     true_lb           true lower bound of datatype (integer)
36   OUT     true_extent       true size of datatype (integer)
37
38
39 int MPI_Type_get_true_extent(MPI_Datatype datatype, MPI_Aint *true_lb,
40                             MPI_Aint *true_extent)
41
42 MPI_Type_get_true_extent(datatype, true_lb, true_extent, ierror) BIND(C)
43   TYPE(MPI_Datatype), INTENT(IN) :: datatype
44   INTEGER(KIND=MPI_ADDRESS_KIND), INTENT(OUT) :: true_lb, true_extent
45   INTEGER, OPTIONAL, INTENT(OUT) :: ierror
46
47 MPI_TYPE_GET_TRUE_EXTENT(DATATYPE, TRUE_LB, TRUE_EXTENT, IERROR)
48   INTEGER DATATYPE, IERROR
49   INTEGER(KIND = MPI_ADDRESS_KIND) TRUE_LB, TRUE_EXTENT

```

ticket-248T.

```
{void MPI::Datatype::Get_true_extent(MPI::Aint& true_lb,
    MPI::Aint& true_extent) const(binding deprecated, see Section 15.2) }
```

`true_lb` returns the offset of the lowest unit of store which is addressed by the datatype, i.e., the lower bound of the corresponding typemap, ignoring `MPI_LB` markers. `true_extent` returns the true size of the datatype, i.e., the extent of the corresponding typemap, ignoring `MPI_LB` and `MPI_UB` markers, and performing no rounding for alignment. If the typemap associated with `datatype` is

$$\text{Typemap} = \{(type_0, disp_0), \dots, (type_{n-1}, disp_{n-1})\}$$

Then

$$\text{true_lb}(\text{Typemap}) = \min_j \{disp_j : type_j \neq \mathbf{lb}, \mathbf{ub}\},$$

$$\text{true_ub}(\text{Typemap}) = \max_j \{disp_j + \text{sizeof}(type_j) : type_j \neq \mathbf{lb}, \mathbf{ub}\},$$

and

$$\text{true_extent}(\text{Typemap}) = \text{true_ub}(\text{Typemap}) - \text{true_lb}(\text{typemap}).$$

(Readers should compare this with the definitions in Section 4.1.6 on page 112 and Section 4.1.7 on page 114, which describe the function `MPI_TYPE_GET_EXTENT`.)

The `true_extent` is the minimum number of bytes of memory necessary to hold a datatype, uncompressed.

For both functions, if either `OUT` parameter cannot express the value to be returned (e.g., if the parameter is too small to hold the output value), it is set to `MPI_UNDEFINED`.

4.1.9 Commit and Free

A datatype object has to be **committed** before it can be used in a communication. As an argument in datatype constructors, uncommitted and also committed datatypes can be used. There is no need to commit basic datatypes. They are “pre-committed.”

`MPI_TYPE_COMMIT(datatype)`

INOUT datatype datatype that is committed (handle)

```
int MPI_Type_commit(MPI_Datatype *datatype)
```

```
MPI_Type_commit(datatype, ierror) BIND(C)
    TYPE(MPI_Datatype), INTENT(INOUT) :: datatype
    INTEGER, OPTIONAL, INTENT(OUT) :: ierror
```

`MPI_TYPE_COMMIT(DATATYPE, IERROR)`

INTEGER DATATYPE, IERROR

```
{void MPI::Datatype::Commit()(binding deprecated, see Section 15.2) }
```

The commit operation commits the datatype, that is, the formal description of a communication buffer, not the content of that buffer. Thus, after a datatype has been committed, it can be repeatedly reused to communicate the changing content of a buffer or, indeed, the content of different buffers, with different starting addresses.

1 *Advice to implementors.* The system may “compile” at commit time an internal
 2 representation for the datatype that facilitates communication, e.g. change from a
 3 compacted representation to a flat representation of the datatype, and select the most
 4 convenient transfer mechanism. (*End of advice to implementors.*)

5
 6 MPI_TYPE_COMMIT will accept a committed datatype; in this case, it is equivalent
 7 to a no-op.

8
 9 **Example 4.10** The following code fragment gives examples of using MPI_TYPE_COMMIT.

```
10 INTEGER type1, type2
11 CALL MPI_TYPE_CONTIGUOUS(5, MPI_REAL, type1, ierr)
12           ! new type object created
13 CALL MPI_TYPE_COMMIT(type1, ierr)
14           ! now type1 can be used for communication
15 type2 = type1
16           ! type2 can be used for communication
17           ! (it is a handle to same object as type1)
18 CALL MPI_TYPE_VECTOR(3, 5, 4, MPI_REAL, type1, ierr)
19           ! new uncommitted type object created
20 CALL MPI_TYPE_COMMIT(type1, ierr)
21           ! now type1 can be used anew for communication
```

```
22
23
24 MPI_TYPE_FREE(datatype)
25           INOUT      datatype                datatype that is freed (handle)
```

```
26
27
28 int MPI_Type_free(MPI_Datatype *datatype)
```

```
29
30 MPI_Type_free(datatype, ierror) BIND(C)
31           TYPE(MPI_Datatype), INTENT(INOUT) :: datatype
32           INTEGER, OPTIONAL, INTENT(OUT) :: ierror
```

```
33 MPI_TYPE_FREE(DATATYPE, IERROR)
34           INTEGER DATATYPE, IERROR
```

```
35
36 {void MPI::Datatype::Free() (binding deprecated, see Section 15.2) }
```

37 Marks the datatype object associated with `datatype` for deallocation and sets `datatype`
 38 to `MPI_DATATYPE_NULL`. Any communication that is currently using this datatype will
 39 complete normally. Freeing a datatype does not affect any other datatype that was built
 40 from the freed datatype. The system behaves as if input datatype arguments to derived
 41 datatype constructors are passed by value.

42
 43 *Advice to implementors.* The implementation may keep a reference count of active
 44 communications that use the datatype, in order to decide when to free it. Also, one
 45 may implement constructors of derived datatypes so that they keep pointers to their
 46 datatype arguments, rather than copying them. In this case, one needs to keep track
 47 of active datatype definition references in order to know when a datatype object can
 48 be freed. (*End of advice to implementors.*)

4.1.10 Duplicating a Datatype

MPI_TYPE_DUP(*oldtype*, *newtype*)

IN [ticket252-W.]*oldtype* datatype (handle)
 OUT *newtype* copy of *oldtype* (handle)

```
int MPI_Type_dup(MPI_Datatype oldtype, MPI_Datatype *newtype)
```

```
MPI_Type_dup(oldtype, newtype, ierror) BIND(C)
  TYPE(MPI_Datatype), INTENT(IN) :: oldtype
  TYPE(MPI_Datatype), INTENT(OUT) :: newtype
  INTEGER, OPTIONAL, INTENT(OUT) :: ierror
```

```
MPI_TYPE_DUP(OLDTYPE, NEWTYPE, IERROR)
  INTEGER OLDTYPE, NEWTYPE, IERROR
```

```
{MPI::Datatype MPI::Datatype::Dup() const(binding deprecated, see Section 15.2) }
```

MPI_TYPE_DUP is a type constructor which duplicates the existing type with associated key values. For each key value, the respective copy callback function determines the attribute value associated with this key in the new communicator; one particular action that a copy callback may take is to delete the attribute from the new datatype. Returns in *newtype* a new datatype with exactly the same properties as *oldtype* and any copied cached information, see Section 6.7.4 on page 289. The new datatype has identical upper bound and lower bound and yields the same net result when fully decoded with the functions in Section 4.1.13. The *newtype* has the same committed state as the old *oldtype*.

4.1.11 Use of General Datatypes in Communication

Handles to derived datatypes can be passed to a communication call wherever a datatype argument is required. A call of the form MPI_SEND(buf, count, datatype, ...), where count > 1, is interpreted as if the call was passed a new datatype which is the concatenation of count copies of datatype. Thus, MPI_SEND(buf, count, datatype, dest, tag, comm) is equivalent to,

```
MPI_TYPE_CONTIGUOUS(count, datatype, newtype)
MPI_TYPE_COMMIT(newtype)
MPI_SEND(buf, 1, newtype, dest, tag, comm).
```

Similar statements apply to all other communication functions that have a count and datatype argument.

Suppose that a send operation MPI_SEND(buf, count, datatype, dest, tag, comm) is executed, where datatype has type map,

$$\{(type_0, disp_0), \dots, (type_{n-1}, disp_{n-1})\},$$

and extent *extent*. (Empty entries of “pseudo-type” MPI_UB and MPI_LB are not listed in the type map, but they affect the value of *extent*.) The send operation sends $n \cdot \text{count}$

1 entries, where entry $i \cdot n + j$ is at location $addr_{i,j} = \text{buf} + \text{extent} \cdot i + \text{disp}_j$ and has type
 2 $type_j$, for $i = 0, \dots, \text{count} - 1$ and $j = 0, \dots, n - 1$. These entries need not be contiguous, nor
 3 distinct; their order can be arbitrary.

4 The variable stored at address $addr_{i,j}$ in the calling program should be of a type that
 5 matches $type_j$, where type matching is defined as in Section 3.3.1. The message sent contains
 6 $n \cdot \text{count}$ entries, where entry $i \cdot n + j$ has type $type_j$.

7 Similarly, suppose that a receive operation `MPI_RECV(buf, count, datatype, source, tag,`
 8 `comm, status)` is executed, where `datatype` has type map,

$$9 \quad \{(type_0, disp_0), \dots, (type_{n-1}, disp_{n-1})\},$$

11 with extent $extent$. (Again, empty entries of “pseudo-type” `MPI_UB` and `MPI_LB` are not
 12 listed in the type map, but they affect the value of $extent$.) This receive operation receives
 13 $n \cdot \text{count}$ entries, where entry $i \cdot n + j$ is at location $\text{buf} + \text{extent} \cdot i + \text{disp}_j$ and has type
 14 $type_j$. If the incoming message consists of k elements, then we must have $k \leq n \cdot \text{count}$; the
 15 $i \cdot n + j$ -th element of the message should have a type that matches $type_j$.

16 Type matching is defined according to the type signature of the corresponding datatypes,
 17 that is, the sequence of basic type components. Type matching does not depend on some
 18 aspects of the datatype definition, such as the displacements (layout in memory) or the
 19 intermediate types used.

21 **Example 4.11** This example shows that type matching is defined in terms of the basic
 22 types that a derived type consists of.

```
23 ...
24 ...
25 CALL MPI_TYPE_CONTIGUOUS( 2, MPI_REAL, type2, ...)
26 CALL MPI_TYPE_CONTIGUOUS( 4, MPI_REAL, type4, ...)
27 CALL MPI_TYPE_CONTIGUOUS( 2, type2, type22, ...)
28 ...
29 CALL MPI_SEND( a, 4, MPI_REAL, ...)
30 CALL MPI_SEND( a, 2, type2, ...)
31 CALL MPI_SEND( a, 1, type22, ...)
32 CALL MPI_SEND( a, 1, type4, ...)
33 ...
34 CALL MPI_RECV( a, 4, MPI_REAL, ...)
35 CALL MPI_RECV( a, 2, type2, ...)
36 CALL MPI_RECV( a, 1, type22, ...)
37 CALL MPI_RECV( a, 1, type4, ...)
```

38 Each of the sends matches any of the receives.

39 A datatype may specify overlapping entries. The use of such a datatype in a receive
 40 operation is erroneous. (This is erroneous even if the actual message received is short enough
 41 not to write any entry more than once.)

42 Suppose that `MPI_RECV(buf, count, datatype, dest, tag, comm, status)` is executed,
 43 where `datatype` has type map,

$$44 \quad \{(type_0, disp_0), \dots, (type_{n-1}, disp_{n-1})\}.$$

45 The received message need not fill all the receive buffer, nor does it need to fill a number of
 46 locations which is a multiple of n . Any number, k , of basic elements can be received, where

$0 \leq k \leq \text{count} \cdot n$. The number of basic elements received can be retrieved from `status` using the query `[function]functions MPI_GET_ELEMENTS` or `MPI_GET_ELEMENTS_X`.

`MPI_GET_ELEMENTS(status, datatype, count)`

IN	<code>status</code>	return status of receive operation (Status)
IN	<code>datatype</code>	datatype used by receive operation (handle)
OUT	<code>count</code>	number of received basic elements (integer)

```
int MPI_Get_elements(const MPI_Status *status, MPI_Datatype datatype,
                    int *count)
```

```
MPI_Get_elements(status, datatype, count, ierror) BIND(C)
    TYPE(MPI_Status), INTENT(IN) :: status
    TYPE(MPI_Datatype), INTENT(IN) :: datatype
    INTEGER, INTENT(OUT) :: count
    INTEGER, OPTIONAL, INTENT(OUT) :: ierror
```

```
MPI_GET_ELEMENTS(STATUS, DATATYPE, COUNT, IERROR)
    INTEGER STATUS(MPI_STATUS_SIZE), DATATYPE, COUNT, IERROR
```

```
{int MPI::Status::Get_elements(const MPI::Datatype& datatype) const(binding
    deprecated, see Section 15.2) }
```

`MPI_GET_ELEMENTS_X(status, datatype, count)`

IN	<code>status</code>	return status of receive operation (Status)
IN	<code>datatype</code>	datatype used by receive operation (handle)
OUT	<code>count</code>	number of received basic elements (integer)

```
int MPI_Get_elements_x(MPI_Status *status, MPI_Datatype datatype,
                       MPI_Count *count)
```

```
MPI_Get_elements_x(status, datatype, count, ierror) BIND(C)
    TYPE(MPI_Status), INTENT(IN) :: status
    TYPE(MPI_Datatype), INTENT(IN) :: datatype
    INTEGER(KIND = MPI_COUNT_KIND), INTENT(OUT) :: count
    INTEGER, OPTIONAL, INTENT(OUT) :: ierror
```

```
MPI_GET_ELEMENTS_X(STATUS, DATATYPE, COUNT, IERROR)
    INTEGER STATUS(MPI_STATUS_SIZE), DATATYPE, IERROR
    INTEGER (KIND=MPI_COUNT_KIND) COUNT
```

The `datatype` argument should match the argument provided by the receive call that set the `status` variable. For both functions, if the `OUT` parameter cannot express the value to be returned (e.g., if the parameter is too small to hold the output value), it is set to `MPI_UNDEFINED`.

The previously defined function `MPI_GET_COUNT[i]` (Section 3.2.5), has a different

behavior. It returns the number of “top-level entries” received, i.e. the number of “copies” of type `datatype`. In the previous example, `MPI_GET_COUNT` may return any integer value k , where $0 \leq k \leq \text{count}$. If `MPI_GET_COUNT` returns k , then the number of basic elements received (and the value returned by `MPI_GET_ELEMENTS`) is $n \cdot k$. If the number of basic elements received is not a multiple of n , that is, if the receive operation has not received an integral number of `datatype` “copies,” then `MPI_GET_COUNT` returns the value `MPI_UNDEFINED`. [The `datatype` argument should match the argument provided by the receive call that set the status variable.]

Example 4.12 Usage of `MPI_GET_COUNT` and `MPI_GET_ELEMENTS`.

```

...
CALL MPI_TYPE_CONTIGUOUS(2, MPI_REAL, Type2, ierr)
CALL MPI_TYPE_COMMIT(Type2, ierr)
...
CALL MPI_COMM_RANK(comm, rank, ierr)
IF (rank.EQ.0) THEN
    CALL MPI_SEND(a, 2, MPI_REAL, 1, 0, comm, ierr)
    CALL MPI_SEND(a, 3, MPI_REAL, 1, 0, comm, ierr)
ELSE IF (rank.EQ.1) THEN
    CALL MPI_RECV(a, 2, Type2, 0, 0, comm, stat, ierr)
    CALL MPI_GET_COUNT(stat, Type2, i, ierr)      ! returns i=1
    CALL MPI_GET_ELEMENTS(stat, Type2, i, ierr)  ! returns i=2
    CALL MPI_RECV(a, 2, Type2, 0, 0, comm, stat, ierr)
    CALL MPI_GET_COUNT(stat, Type2, i, ierr)    ! returns i=MPI_UNDEFINED
    CALL MPI_GET_ELEMENTS(stat, Type2, i, ierr) ! returns i=3
END IF

```

The function `MPI_GET_ELEMENTS` can also be used after a probe to find the number of elements in the probed message. Note that the [two] functions `MPI_GET_COUNT` [and], `MPI_GET_ELEMENTS`, and `MPI_GET_ELEMENTS_X` return the same values when they are used with basic datatypes so long as the limits of their respective count arguments are not exceeded.

Rationale. The extension given to the definition of `MPI_GET_COUNT` seems natural: one would expect this function to return the value of the count argument, when the receive buffer is filled. Sometimes `datatype` represents a basic unit of data one wants to transfer, for example, a record in an array of records (structures). One should be able to find out how many components were received without bothering to divide by the number of elements in each component. However, on other occasions, `datatype` is used to define a complex layout of data in the receiver memory, and does not represent a basic unit of data for transfers. In such cases, one needs to use the function `MPI_GET_ELEMENTS`. (*End of rationale.*)

Advice to implementors. The definition implies that a receive cannot change the value of storage outside the entries defined to compose the communication buffer. In particular, the definition implies that padding space in a structure should not be modified when such a structure is copied from one process to another. This would prevent the obvious optimization of copying the structure, together with the padding, as one

contiguous block. The implementation is free to do this optimization when it does not impact the outcome of the computation. The user can “force” this optimization by explicitly including padding as part of the message. (*End of advice to implementors.*)

4.1.12 Correct Use of Addresses

Successively declared variables in C or Fortran are not necessarily stored at contiguous locations. Thus, care must be exercised that displacements do not cross from one variable to another. Also, in machines with a segmented address space, addresses are not unique and address arithmetic has some peculiar properties. Thus, the use of **addresses**, that is, displacements relative to the start address `MPI_BOTTOM`, has to be restricted.

Variables belong to the same **sequential storage** if they belong to the same array, to the same `COMMON` block in Fortran, or to the same structure in C. Valid addresses are defined recursively as follows:

1. The function `MPI_GET_ADDRESS` returns a valid address, when passed as argument a variable of the calling program.
2. The `buf` argument of a communication function evaluates to a valid address, when passed as argument a variable of the calling program.
3. If `v` is a valid address, and `i` is an integer, then `v+i` is a valid address, provided `v` and `v+i` are in the same sequential storage.
4. If `v` is a valid address then `MPI_BOTTOM + v` is a valid address.

A correct program uses only valid addresses to identify the locations of entries in communication buffers. Furthermore, if `u` and `v` are two valid addresses, then the (integer) difference `u - v` can be computed only if both `u` and `v` are in the same sequential storage. No other arithmetic operations can be meaningfully executed on addresses.

The rules above impose no constraints on the use of derived datatypes, as long as they are used to define a communication buffer that is wholly contained within the same sequential storage. However, the construction of a communication buffer that contains variables that are not within the same sequential storage must obey certain restrictions. Basically, a communication buffer with variables that are not within the same sequential storage can be used only by specifying in the communication call `buf = MPI_BOTTOM`, `count = 1`, and using a `datatype` argument where all displacements are valid (absolute) addresses.

Advice to users. It is not expected that MPI implementations will be able to detect erroneous, “out of bound” displacements — unless those overflow the user address space — since the MPI call may not know the extent of the arrays and records in the host program. (*End of advice to users.*)

Advice to implementors. There is no need to distinguish (absolute) addresses and (relative) displacements on a machine with contiguous address space: `MPI_BOTTOM` is zero, and both addresses and displacements are integers. On machines where the distinction is required, addresses are recognized as expressions that involve `MPI_BOTTOM`. (*End of advice to implementors.*)

4.1.13 Decoding a Datatype

MPI datatype objects allow users to specify an arbitrary layout of data in memory. There are several cases where accessing the layout information in opaque datatype objects would be useful. The opaque datatype object has found a number of uses outside MPI. Furthermore, a number of tools wish to display internal information about a datatype. To achieve this, datatype decoding functions are provided. The two functions in this section are used together to decode datatypes to recreate the calling sequence used in their initial definition. These can be used to allow a user to determine the type map and type signature of a datatype.

```
MPI_TYPE_GET_ENVELOPE(datatype, num_integers, num_addresses, num_datatypes, combiner)
```

IN	datatype	datatype to access (handle)
OUT	num_integers	number of input integers used in the call constructing combiner (non-negative integer)
OUT	num_addresses	number of input addresses used in the call constructing combiner (non-negative integer)
OUT	num_datatypes	number of input datatypes used in the call constructing combiner (non-negative integer)
OUT	combiner	combiner (state)

```
int MPI_Type_get_envelope(MPI_Datatype datatype, int *num_integers,
                          int *num_addresses, int *num_datatypes, int *combiner)
```

```
MPI_Type_get_envelope(datatype, num_integers, num_addresses, num_datatypes,
                      combiner, ierror) BIND(C)
  TYPE(MPI_Datatype), INTENT(IN) :: datatype
  INTEGER, INTENT(OUT) :: num_integers, num_addresses, num_datatypes,
  combiner
  INTEGER, OPTIONAL, INTENT(OUT) :: ierror
```

```
MPI_TYPE_GET_ENVELOPE(DATATYPE, NUM_INTEGERS, NUM_ADDRESSES, NUM_DATATYPES,
                      COMBINER, IERROR)
  INTEGER DATATYPE, NUM_INTEGERS, NUM_ADDRESSES, NUM_DATATYPES, COMBINER,
  IERROR
```

```
{void MPI::Datatype::Get_envelope(int& num_integers, int& num_addresses,
                                  int& num_datatypes, int& combiner) const(binding deprecated, see
                                  Section 15.2) }
```

For the given datatype, `MPI_TYPE_GET_ENVELOPE` returns information on the number and type of input arguments used in the call that created the `datatype`. The number-of-arguments values returned can be used to provide sufficiently large arrays in the decoding routine `MPI_TYPE_GET_CONTENTS`. This call and the meaning of the returned values is described below. The combiner reflects the MPI datatype constructor call that was used in creating `datatype`.

Rationale. By requiring that the combiner reflect the constructor used in the creation of the datatype, the decoded information can be used to effectively recreate the calling sequence used in the original creation. One call is effectively the same as another when the information obtained from `MPI_TYPE_GET_CONTENTS` may be used with either to produce the same outcome. C calls `MPI_Type_hindexed` and `MPI_Type_create_hindexed` are always effectively the same while the Fortran call `MPI_TYPE_HINDEXED` will be different than either of these in some MPI implementations. This is the most useful information and was felt to be reasonable even though it constrains implementations to remember the original constructor sequence even if the internal representation is different.

The decoded information keeps track of datatype duplications. This is important as one needs to distinguish between a predefined datatype and a dup of a predefined datatype. The former is a constant object that cannot be freed, while the latter is a derived datatype that can be freed. (*End of rationale.*)

The list below has the values that can be returned in `combiner` on the left and the call associated with them on the right.

<code>MPI_COMBINER_NAMED</code>	a named predefined datatype
<code>MPI_COMBINER_DUP</code>	<code>MPI_TYPE_DUP</code>
<code>MPI_COMBINER_CONTIGUOUS</code>	<code>MPI_TYPE_CONTIGUOUS</code>
<code>MPI_COMBINER_VECTOR</code>	<code>MPI_TYPE_VECTOR</code>
<code>MPI_COMBINER_HVECTOR_INTEGER</code>	<code>MPI_TYPE_HVECTOR</code> from Fortran
<code>MPI_COMBINER_HVECTOR</code>	<code>MPI_TYPE_HVECTOR</code> from C or C++ and in some case Fortran or <code>MPI_TYPE_CREATE_HVECTOR</code>
<code>MPI_COMBINER_INDEXED</code>	<code>MPI_TYPE_INDEXED</code>
<code>MPI_COMBINER_HINDEXED_INTEGER</code>	<code>MPI_TYPE_HINDEXED</code> from Fortran
<code>MPI_COMBINER_HINDEXED</code>	<code>MPI_TYPE_HINDEXED</code> from C or C++ and in some case Fortran or <code>MPI_TYPE_CREATE_HINDEXED</code>
<code>MPI_COMBINER_INDEXED_BLOCK</code>	<code>MPI_TYPE_CREATE_INDEXED_BLOCK</code>
<code>[ticket280.]MPI_COMBINER_HINDEXED_BLOCK</code>	<code>[ticket280.]MPI_TYPE_CREATE_HINDEXED_BLOCK</code>
<code>MPI_COMBINER_STRUCT_INTEGER</code>	<code>MPI_TYPE_STRUCT</code> from Fortran
<code>MPI_COMBINER_STRUCT</code>	<code>MPI_TYPE_STRUCT</code> from C or C++ and in some case Fortran or <code>MPI_TYPE_CREATE_STRUCT</code>
<code>MPI_COMBINER_SUBARRAY</code>	<code>MPI_TYPE_CREATE_SUBARRAY</code>
<code>MPI_COMBINER_DARRAY</code>	<code>MPI_TYPE_CREATE_DARRAY</code>
<code>MPI_COMBINER_F90_REAL</code>	<code>MPI_TYPE_CREATE_F90_REAL</code>
<code>MPI_COMBINER_F90_COMPLEX</code>	<code>MPI_TYPE_CREATE_F90_COMPLEX</code>
<code>MPI_COMBINER_F90_INTEGER</code>	<code>MPI_TYPE_CREATE_F90_INTEGER</code>
<code>MPI_COMBINER_RESIZED</code>	<code>MPI_TYPE_CREATE_RESIZED</code>

Table 4.1: `combiner` values returned from `MPI_TYPE_GET_ENVELOPE`

1 If combiner is `MPI_COMBINER_NAMED` then `datatype` is a named predefined datatype.

2 For deprecated calls with address arguments, we sometimes need to differentiate whether
 3 the call used an integer or an address size argument. For example, there are two combin-
 4 ers for `hvector`: `MPI_COMBINER_HVECTOR_INTEGER` and `MPI_COMBINER_HVECTOR`. The
 5 former is used if it was the MPI-1 call from Fortran, and the latter is used if it was the
 6 MPI-1 call from C or C++. However, on systems where `MPI_ADDRESS_KIND =`
 7 `MPI_INTEGER_KIND` (i.e., where integer arguments and address size arguments are the same),
 8 the combiner `MPI_COMBINER_HVECTOR` may be returned for a datatype constructed by a
 9 call to `MPI_TYPE_HVECTOR` from Fortran. Similarly, `MPI_COMBINER_HINDEXED` may
 10 be returned for a datatype constructed by a call to `MPI_TYPE_HINDEXED` from Fortran,
 11 and `MPI_COMBINER_STRUCT` may be returned for a datatype constructed by a call to
 12 `MPI_TYPE_STRUCT` from Fortran. On such systems, one need not differentiate construc-
 13 tors that take address size arguments from constructors that take integer arguments, since
 14 these are the same. The preferred calls all use address sized arguments so two combiners
 15 are not required for them.

16
 17 *Rationale.* For recreating the original call, it is important to know if address informa-
 18 tion may have been truncated. The deprecated calls from Fortran for a few routines
 19 could be subject to truncation in the case where the default `INTEGER` size is smaller
 20 than the size of an address. (*End of rationale.*)

21
 22 The actual arguments used in the creation call for a datatype can be obtained from the
 23 call:

24
 25 `MPI_TYPE_GET_CONTENTS(datatype, max_integers, max_addresses, max_datatypes, ar-`
 26 `ray_of_integers, array_of_addresses, array_of_datatypes)`
 27
 28 IN `datatype` datatype to access (handle)
 29 IN `max_integers` number of elements in `array_of_integers` (non-negative
 30 integer)
 31 IN `max_addresses` number of elements in `array_of_addresses` (non-negative
 32 integer)
 33 IN `max_datatypes` number of elements in `array_of_datatypes` (non-negative
 34 integer)
 35
 36 OUT `array_of_integers` contains integer arguments used in constructing
 37 datatype (array of integers)
 38 OUT `array_of_addresses` contains address arguments used in constructing
 39 datatype (array of integers)
 40 OUT `array_of_datatypes` contains datatype arguments used in constructing
 41 datatype (array of handles)
 42
 43

44 `int MPI_Type_get_contents(MPI_Datatype datatype, int max_integers,`
 45 `int max_addresses, int max_datatypes, int array_of_integers[],`
 46 `MPI_Aint array_of_addresses[],`
 47 `MPI_Datatype array_of_datatypes[])`

ticket-248T. 48

```

MPI_Type_get_contents(datatype, max_integers, max_addresses, max_datatypes,
    array_of_integers, array_of_addresses, array_of_datatypes,
    ierror) BIND(C)
TYPE(MPI_Datatype), INTENT(IN) :: datatype
INTEGER, INTENT(IN) :: max_integers, max_addresses, max_datatypes
INTEGER, INTENT(OUT) :: array_of_integers(max_integers)
INTEGER(KIND=MPI_ADDRESS_KIND), INTENT(OUT) ::
array_of_addresses(max_addresses)
TYPE(MPI_Datatype), INTENT(OUT) :: array_of_datatypes(max_datatypes)
INTEGER, OPTIONAL, INTENT(OUT) :: ierror

MPI_TYPE_GET_CONTENTS(DATATYPE, MAX_INTEGERS, MAX_ADDRESSES, MAX_DATATYPES,
    ARRAY_OF_INTEGERS, ARRAY_OF_ADDRESSES, ARRAY_OF_DATATYPES,
    IERROR)
INTEGER DATATYPE, MAX_INTEGERS, MAX_ADDRESSES, MAX_DATATYPES,
ARRAY_OF_INTEGERS(*), ARRAY_OF_DATATYPES(*), IERROR
INTEGER(KIND=MPI_ADDRESS_KIND) ARRAY_OF_ADDRESSES(*)

{void MPI::Datatype::Get_contents(int max_integers, int max_addresses,
    int max_datatypes, int array_of_integers[],
    MPI::Aint array_of_addresses[],
    MPI::Datatype array_of_datatypes[]) const(binding deprecated, see
    Section 15.2) }
```

datatype must be a predefined unnamed or a derived datatype; the call is erroneous if datatype is a predefined named datatype.

The values given for max_integers, max_addresses, and max_datatypes must be at least as large as the value returned in num_integers, num_addresses, and num_datatypes, respectively, in the call MPI_TYPE_GET_ENVELOPE for the same datatype argument.

Rationale. The arguments max_integers, max_addresses, and max_datatypes allow for error checking in the call. (*End of rationale.*)

The datatypes returned in array_of_datatypes are handles to datatype objects that are equivalent to the datatypes used in the original construction call. If these were derived datatypes, then the returned datatypes are new datatype objects, and the user is responsible for freeing these datatypes with MPI_TYPE_FREE. If these were predefined datatypes, then the returned datatype is equal to that (constant) predefined datatype and cannot be freed.

The committed state of returned derived datatypes is undefined, i.e., the datatypes may or may not be committed. Furthermore, the content of attributes of returned datatypes is undefined.

Note that MPI_TYPE_GET_CONTENTS can be invoked with a datatype argument that was constructed using MPI_TYPE_CREATE_F90_REAL, MPI_TYPE_CREATE_F90_INTEGER, or MPI_TYPE_CREATE_F90_COMPLEX (an unnamed predefined datatype). In such a case, an empty array_of_datatypes is returned.

Rationale. The definition of datatype equivalence implies that equivalent predefined datatypes are equal. By requiring the same handle for named predefined datatypes, it is possible to use the == or .EQ. comparison operator to determine the datatype involved. (*End of rationale.*)

Advice to implementors. The datatypes returned in `array_of_datatypes` must appear to the user as if each is an equivalent copy of the datatype used in the type constructor call. Whether this is done by creating a new datatype or via another mechanism such as a reference count mechanism is up to the implementation as long as the semantics are preserved. (*End of advice to implementors.*)

Rationale. The committed state and attributes of the returned datatype is deliberately left vague. The datatype used in the original construction may have been modified since its use in the constructor call. Attributes can be added, removed, or modified as well as having the datatype committed. The semantics given allow for a reference count implementation without having to track these changes. (*End of rationale.*)

In the deprecated datatype constructor calls, the address arguments in Fortran are of type `INTEGER`. In the preferred calls, the address arguments are of type `INTEGER(KIND=MPI_ADDRESS_KIND)`. The call `MPI_TYPE_GET_CONTENTS` returns all addresses in an argument of type `INTEGER(KIND=MPI_ADDRESS_KIND)`. This is true even if the deprecated calls were used. Thus, the location of values returned can be thought of as being returned by the C bindings. It can also be determined by examining the preferred calls for datatype constructors for the deprecated calls that involve addresses.

Rationale. By having all address arguments returned in the `array_of_addresses` argument, the result from a C and Fortran decoding of a datatype gives the result in the same argument. It is assumed that an integer of type `INTEGER(KIND=MPI_ADDRESS_KIND)` will be at least as large as the `INTEGER` argument used in datatype construction with the old MPI-1 calls so no loss of information will occur. (*End of rationale.*)

The following defines what values are placed in each entry of the returned arrays depending on the datatype constructor used for `datatype`. It also specifies the size of the arrays needed which is the values returned by `MPI_TYPE_GET_ENVELOPE`. In Fortran, the following calls were made:

```

33     PARAMETER (LARGE = 1000)
34     INTEGER TYPE, NI, NA, ND, COMBINER, I(LARGE), D(LARGE), IERROR
35     INTEGER(KIND=MPI_ADDRESS_KIND) A(LARGE)
36 !   CONSTRUCT DATATYPE TYPE (NOT SHOWN)
37     CALL MPI_TYPE_GET_ENVELOPE(TYPE, NI, NA, ND, COMBINER, IERROR)
38     IF ((NI .GT. LARGE) .OR. (NA .GT. LARGE) .OR. (ND .GT. LARGE)) THEN
39         WRITE (*, *) "NI, NA, OR ND = ", NI, NA, ND, &
40             " RETURNED BY MPI_TYPE_GET_ENVELOPE IS LARGER THAN LARGE = ", LARGE
41         CALL MPI_ABORT(MPI_COMM_WORLD, 99, IERROR)
42     ENDIF
43     CALL MPI_TYPE_GET_CONTENTS(TYPE, NI, NA, ND, I, A, D, IERROR)
44 
```

or in C the analogous calls of:

```

47 #define LARGE 1000
48 int ni, na, nd, combiner, i[LARGE];

```



```

MPI_Aint a[LARGE];
MPI_Datatype type, d[LARGE];
/* construct datatype type (not shown) */
MPI_Type_get_envelope(type, &ni, &na, &nd, &combiner);
if ((ni > LARGE) || (na > LARGE) || (nd > LARGE)) {
    fprintf(stderr, "ni, na, or nd = %d %d %d returned by ", ni, na, nd);
    fprintf(stderr, "MPI_Type_get_envelope is larger than LARGE = %d\n",
            LARGE);
    MPI_Abort(MPI_COMM_WORLD, 99);
};
MPI_Type_get_contents(type, ni, na, nd, i, a, d);

```

The C++ code is in analogy to the C code above with the same values returned.

In the descriptions that follow, the lower case name of arguments is used.

If combiner is MPI_COMBINER_NAMED then it is erroneous to call

MPI_TYPE_GET_CONTENTS.

If combiner is MPI_COMBINER_DUP then

Constructor argument	C & C++ location	Fortran location
oldtype	d[0]	D(1)

and ni = 0, na = 0, nd = 1.

If combiner is MPI_COMBINER_CONTIGUOUS then

Constructor argument	C & C++ location	Fortran location
count	i[0]	I(1)
oldtype	d[0]	D(1)

and ni = 1, na = 0, nd = 1.

If combiner is MPI_COMBINER_VECTOR then

Constructor argument	C & C++ location	Fortran location
count	i[0]	I(1)
blocklength	i[1]	I(2)
stride	i[2]	I(3)
oldtype	d[0]	D(1)

and ni = 3, na = 0, nd = 1.

If combiner is MPI_COMBINER_HVECTOR_INTEGER or MPI_COMBINER_HVECTOR then

Constructor argument	C & C++ location	Fortran location
count	i[0]	I(1)
blocklength	i[1]	I(2)
stride	a[0]	A(1)
oldtype	d[0]	D(1)

and ni = 2, na = 1, nd = 1.

If combiner is MPI_COMBINER_INDEXED then

Constructor argument	C & C++ location	Fortran location
count	i[0]	I(1)
array_of_blocklengths	i[1] to i[i[0]]	I(2) to I(I(1)+1)
array_of_displacements	i[i[0]+1] to i[2*i[0]]	I(I(1)+2) to I(2*I(1)+1)
oldtype	d[0]	D(1)

1 and $ni = 2*count+1$, $na = 0$, $nd = 1$.

2 If combiner is `MPI_COMBINER_HINDEXED_INTEGER` or `MPI_COMBINER_HINDEXED` then

3 Constructor argument	C & C++ location	Fortran location
4 count	$i[0]$	I(1)
5 array_of_blocklengths	$i[1]$ to $i[i[0]]$	I(2) to I(I(1)+1)
6 array_of_displacements	$a[0]$ to $a[i[0]-1]$	A(1) to A(I(1))
7 oldtype	$d[0]$	D(1)

8 and $ni = count+1$, $na = count$, $nd = 1$.

9 If combiner is `MPI_COMBINER_INDEXED_BLOCK` then

11 Constructor argument	C & C++ location	Fortran location
12 count	$i[0]$	I(1)
13 blocklength	$i[1]$	I(2)
14 array_of_displacements	$i[2]$ to $i[i[0]+1]$	I(3) to I(I(1)+2)
15 oldtype	$d[0]$	D(1)

16 and $ni = count+2$, $na = 0$, $nd = 1$.

17 If combiner is `MPI_COMBINER_HINDEXED_BLOCK` then

19 Constructor argument	C & C++ location	Fortran location
20 count	$i[0]$	I(1)
21 blocklength	$i[1]$	I(2)
22 array_of_displacements	$a[0]$ to $a[i[0]-1]$	A(1) to A(I(1))
23 oldtype	$d[0]$	D(1)

24 and $ni = 2$, $na = count$, $nd = 1$.

25 If combiner is `MPI_COMBINER_STRUCT_INTEGER` or `MPI_COMBINER_STRUCT` then

27 Constructor argument	C & C++ location	Fortran location
28 count	$i[0]$	I(1)
29 array_of_blocklengths	$i[1]$ to $i[i[0]]$	I(2) to I(I(1)+1)
30 array_of_displacements	$a[0]$ to $a[i[0]-1]$	A(1) to A(I(1))
31 array_of_types	$d[0]$ to $d[i[0]-1]$	D(1) to D(I(1))

32 and $ni = count+1$, $na = count$, $nd = count$.

33 If combiner is `MPI_COMBINER_SUBARRAY` then

34 Constructor argument	C & C++ location	Fortran location
35 ndims	$i[0]$	I(1)
36 array_of_sizes	$i[1]$ to $i[i[0]]$	I(2) to I(I(1)+1)
37 array_of_subsizes	$i[i[0]+1]$ to $i[2*i[0]]$	I(I(1)+2) to I(2*I(1)+1)
38 array_of_starts	$i[2*i[0]+1]$ to $i[3*i[0]]$	I(2*I(1)+2) to I(3*I(1)+1)
39 order	$i[3*i[0]+1]$	I(3*I(1)+2)
40 oldtype	$d[0]$	D(1)

41 and $ni = 3*ndims+2$, $na = 0$, $nd = 1$.

42 If combiner is `MPI_COMBINER_DARRAY` then

43
44
45
46
47
48

Constructor argument	C & C++ location	Fortran location
size	i[0]	I(1)
rank	i[1]	I(2)
ndims	i[2]	I(3)
array_of_gsizes	i[3] to i[i[2]+2]	I(4) to I(I(3)+3)
array_of_distribs	i[i[2]+3] to i[2*i[2]+2]	I(I(3)+4) to I(2*I(3)+3)
array_of_dargs	i[2*i[2]+3] to i[3*i[2]+2]	I(2*I(3)+4) to I(3*I(3)+3)
array_of_psizes	i[3*i[2]+3] to i[4*i[2]+2]	I(3*I(3)+4) to I(4*I(3)+3)
order	i[4*i[2]+3]	I(4*I(3)+4)
oldtype	d[0]	D(1)

and ni = 4*ndims+4, na = 0, nd = 1.

If combiner is MPI_COMBINER_F90_REAL then

Constructor argument	C & C++ location	Fortran location
p	i[0]	I(1)
r	i[1]	I(2)

and ni = 2, na = 0, nd = 0.

If combiner is MPI_COMBINER_F90_COMPLEX then

Constructor argument	C & C++ location	Fortran location
p	i[0]	I(1)
r	i[1]	I(2)

and ni = 2, na = 0, nd = 0.

If combiner is MPI_COMBINER_F90_INTEGER then

Constructor argument	C & C++ location	Fortran location
r	i[0]	I(1)

and ni = 1, na = 0, nd = 0.

If combiner is MPI_COMBINER_RESIZED then

Constructor argument	C & C++ location	Fortran location
lb	a[0]	A(1)
extent	a[1]	A(2)
oldtype	d[0]	D(1)

and ni = 0, na = 2, nd = 1.

4.1.14 Examples

The following examples illustrate the use of derived datatypes.

Example 4.13 Send and receive a section of a 3D array.

```

REAL a(100,100,100), e(9,9,9)
INTEGER oneslice, twoslice, threeslice, sizeofreal, myrank, ierr
INTEGER status(MPI_STATUS_SIZE)

```

```

C   extract the section a(1:17:2, 3:11, 2:10)
C   and store it in e(:, :, :).

```

```

1      CALL MPI_COMM_RANK(MPI_COMM_WORLD, myrank, ierr)
2
3      CALL MPI_TYPE_EXTENT( MPI_REAL, sizeofreal, ierr)
4
5      C      create datatype for a 1D section
6      CALL MPI_TYPE_VECTOR( 9, 1, 2, MPI_REAL, oneslice, ierr)
7
8      C      create datatype for a 2D section
9      CALL MPI_TYPE_HVECTOR(9, 1, 100*sizeofreal, oneslice, twoslice, ierr)
10
11     C      create datatype for the entire section
12     CALL MPI_TYPE_HVECTOR( 9, 1, 100*100*sizeofreal, twoslice,
13                          threeslice, ierr)
14
15     CALL MPI_TYPE_COMMIT( threeslice, ierr)
16     CALL MPI_SENDRECV(a(1,3,2), 1, threeslice, myrank, 0, e, 9*9*9,
17                      MPI_REAL, myrank, 0, MPI_COMM_WORLD, status, ierr)
18
19

```

Example 4.14 Copy the (strictly) lower triangular part of a matrix.

```

21     REAL a(100,100), b(100,100)
22     INTEGER disp(100), blocklen(100), ltype, myrank, ierr
23     INTEGER status(MPI_STATUS_SIZE)
24
25     C      copy lower triangular part of array a
26     C      onto lower triangular part of array b
27
28     CALL MPI_COMM_RANK(MPI_COMM_WORLD, myrank, ierr)
29
30     C      compute start and size of each column
31     DO i=1, 100
32         disp(i) = 100*(i-1) + i
33         blocklen(i) = 100-i
34     END DO
35
36     C      create datatype for lower triangular part
37     CALL MPI_TYPE_INDEXED( 100, blocklen, disp, MPI_REAL, ltype, ierr)
38
39     CALL MPI_TYPE_COMMIT(ltype, ierr)
40     CALL MPI_SENDRECV( a, 1, ltype, myrank, 0, b, 1,
41                      ltype, myrank, 0, MPI_COMM_WORLD, status, ierr)
42
43

```

Example 4.15 Transpose a matrix.

```

45     REAL a(100,100), b(100,100)
46     INTEGER row, xpose, sizeofreal, myrank, ierr
47     INTEGER status(MPI_STATUS_SIZE)
48

```

```

C      transpose matrix a onto b
                                           1
                                           2
                                           3
      CALL MPI_COMM_RANK(MPI_COMM_WORLD, myrank, ierr)
                                           4
                                           5
      CALL MPI_TYPE_EXTENT( MPI_REAL, sizeofreal, ierr)
                                           6
                                           7
C      create datatype for one row
                                           8
      CALL MPI_TYPE_VECTOR( 100, 1, 100, MPI_REAL, row, ierr)
                                           9
                                           10
C      create datatype for matrix in row-major order
                                           11
      CALL MPI_TYPE_HVECTOR( 100, 1, sizeofreal, row, xpose, ierr)
                                           12
                                           13
      CALL MPI_TYPE_COMMIT( xpose, ierr)
                                           14
                                           15
C      send matrix in row-major order and receive in column major order
                                           16
      CALL MPI_SENDRECV( a, 1, xpose, myrank, 0, b, 100*100,
                        MPI_REAL, myrank, 0, MPI_COMM_WORLD, status, ierr)
                                           17
                                           18
                                           19

```

Example 4.16 Another approach to the transpose problem:

```

      REAL a(100,100), b(100,100)
                                           22
      INTEGER disp(2), blocklen(2), type(2), row, row1, sizeofreal
                                           23
      INTEGER myrank, ierr
                                           24
      INTEGER status(MPI_STATUS_SIZE)
                                           25
                                           26
      CALL MPI_COMM_RANK(MPI_COMM_WORLD, myrank, ierr)
                                           27
                                           28
C      transpose matrix a onto b
                                           29
                                           30
      CALL MPI_TYPE_EXTENT( MPI_REAL, sizeofreal, ierr)
                                           31
                                           32
C      create datatype for one row
                                           33
      CALL MPI_TYPE_VECTOR( 100, 1, 100, MPI_REAL, row, ierr)
                                           34
                                           35
C      create datatype for one row, with the extent of one real number
                                           36
      disp(1) = 0
                                           37
      disp(2) = sizeofreal
                                           38
      type(1) = row
                                           39
      type(2) = MPI_UB
                                           40
      blocklen(1) = 1
                                           41
      blocklen(2) = 1
                                           42
      CALL MPI_TYPE_STRUCT( 2, blocklen, disp, type, row1, ierr)
                                           43
                                           44
      CALL MPI_TYPE_COMMIT( row1, ierr)
                                           45
                                           46
C      send 100 rows and receive in column major order
                                           47
      CALL MPI_SENDRECV( a, 100, row1, myrank, 0, b, 100*100,
                        MPI_REAL, myrank, 0, MPI_COMM_WORLD, status, ierr)
                                           48

```

```

1           MPI_REAL, myrank, 0, MPI_COMM_WORLD, status, ierr)
2
3

```

Example 4.17 We manipulate an array of structures.

```

4
5 struct Partstruct
6     {
7         int    class; /* particle class */
8         double d[6]; /* particle coordinates */
9         char   b[7]; /* some additional information */
10    };
11
12 struct Partstruct    particle[1000];
13
14 int                i, dest, rank, tag;
15 MPI_Comm          comm;
16
17
18 /* build datatype describing structure */
19
20 MPI_Datatype Particletype;
21 MPI_Datatype type[3] = {MPI_INT, MPI_DOUBLE, MPI_CHAR};
22 int          blocklen[3] = {1, 6, 7};
23 MPI_Aint     disp[3];
24 MPI_Aint     base;
25
26
27 /* compute displacements of structure components */
28
29 MPI_Address( particle, disp);
30 MPI_Address( particle[0].d, disp+1);
31 MPI_Address( particle[0].b, disp+2);
32 base = disp[0];
33 for (i=0; i < 3; i++) disp[i] -= base;
34
35 MPI_Type_struct( 3, blocklen, disp, type, &Particletype);
36
37     /* If compiler does padding in mysterious ways,
38     the following may be safer */
39
40 MPI_Datatype type1[4] = {MPI_INT, MPI_DOUBLE, MPI_CHAR, MPI_UB};
41 int          blocklen1[4] = {1, 6, 7, 1};
42 MPI_Aint     disp1[4];
43
44 /* compute displacements of structure components */
45
46 MPI_Address( particle, disp1);
47 MPI_Address( particle[0].d, disp1+1);
48 MPI_Address( particle[0].b, disp1+2);

```

```

MPI_Address( particle+1, disp1+3);      1
base = disp1[0];                        2
for (i=0; i < 4; i++) disp1[i] -= base; 3
                                        4
/* build datatype describing structure */ 5
                                        6
MPI_Type_struct( 4, blocklen1, disp1, type1, &Particletype); 7
                                        8
                                        9
                /* 4.1:                10
                send the entire array */ 11
                                        12
MPI_Type_commit( &Particletype);       13
MPI_Send( particle, 1000, Particletype, dest, tag, comm); 14
                                        15
                                        16
                /* 4.2:                17
                send only the entries of class zero particles, 18
                preceded by the number of such entries */ 19
                                        20
MPI_Datatype Zparticles; /* datatype describing all particles 21
                        with class zero (needs to be recomputed 22
                        if classes change) */ 23
MPI_Datatype Ztype; 24
                                        25
MPI_Aint      zdisp[1000]; 26
int           zblock[1000], j, k; 27
int           zzblock[2] = {1,1}; 28
MPI_Aint      zzdisp[2]; 29
MPI_Datatype  zztype[2]; 30
                                        31
/* compute displacements of class zero particles */ 32
j = 0; 33
for(i=0; i < 1000; i++) 34
    if (particle[i].class == 0) 35
        { 36
            zdisp[j] = i; 37
            zblock[j] = 1; 38
            j++; 39
        } 40
                                        41
/* create datatype for class zero particles */ 42
MPI_Type_indexed( j, zblock, zdisp, Particletype, &Zparticles); 43
                                        44
/* prepend particle count */ 45
MPI_Address(&j, zzdisp); 46
MPI_Address(particle, zzdisp+1); 47
zztype[0] = MPI_INT; 48

```

```

1  zztype[1] = Zparticles;
2  MPI_Type_struct(2, zzbblock, zzdisp, zztype, &Ztype);
3
4  MPI_Type_commit( &Ztype);
5  MPI_Send( MPI_BOTTOM, 1, Ztype, dest, tag, comm);
6
7
8      /* A probably more efficient way of defining Zparticles */
9
10     /* consecutive particles with index zero are handled as one block */
11     j=0;
12     for (i=0; i < 1000; i++)
13         if (particle[i].index == 0)
14             {
15                 for (k=i+1; (k < 1000)&&(particle[k].index == 0) ; k++);
16                 zdisp[j] = i;
17                 zblock[j] = k-i;
18                 j++;
19                 i = k;
20             }
21     MPI_Type_indexed( j, zblock, zdisp, Particletype, &Zparticles);
22
23
24         /* 4.3:
25         send the first two coordinates of all entries */
26
27     MPI_Datatype Allpairs;      /* datatype for all pairs of coordinates */
28
29     MPI_Aint sizeofentry;
30
31     MPI_Type_extent( Particletype, &sizeofentry);
32
33     /* sizeofentry can also be computed by subtracting the address
34     of particle[0] from the address of particle[1] */
35
36     MPI_Type_hvector( 1000, 2, sizeofentry, MPI_DOUBLE, &Allpairs);
37     MPI_Type_commit( &Allpairs);
38     MPI_Send( particle[0].d, 1, Allpairs, dest, tag, comm);
39
40     /* an alternative solution to 4.3 */
41
42     MPI_Datatype Onepair;      /* datatype for one pair of coordinates, with
43                                the extent of one particle entry */
44     MPI_Aint disp2[3];
45     MPI_Datatype type2[3] = {MPI_LB, MPI_DOUBLE, MPI_UB};
46     int blocklen2[3] = {1, 2, 1};
47
48     MPI_Address( particle, disp2);

```



```

MPI_Address( particle[0].d, disp2+1); 1
MPI_Address( particle+1, disp2+2);    2
base = disp2[0];                      3
for (i=0; i<2; i++) disp2[i] -= base; 4
                                        5

MPI_Type_struct( 3, blocklen2, disp2, type2, &Onepair); 6
MPI_Type_commit( &Onepair);          7
MPI_Send( particle[0].d, 1000, Onepair, dest, tag, comm); 8
                                        9
                                        10
                                        11

```

Example 4.18 The same manipulations as in the previous example, but use absolute addresses in datatypes. 12

```

struct Partstruct 14
{
    int class;      15
    double d[6];   16
    char b[7];     17
};                18
                19
                20
                21
struct Partstruct particle[1000]; 22
                23
                /* build datatype describing first array entry */ 24
                25

MPI_Datatype Particletype; 26
MPI_Datatype type[3] = {MPI_INT, MPI_DOUBLE, MPI_CHAR}; 27
int          block[3] = {1, 6, 7}; 28
MPI_Aint     disp[3]; 29
                30

MPI_Address( particle, disp); 31
MPI_Address( particle[0].d, disp+1); 32
MPI_Address( particle[0].b, disp+2); 33
MPI_Type_struct( 3, block, disp, type, &Particletype); 34
                35

/* Particletype describes first array entry -- using absolute 36
   addresses */ 37
                38
                /* 5.1: 39
   send the entire array */ 40
                41

MPI_Type_commit( &Particletype); 42
MPI_Send( MPI_BOTTOM, 1000, Particletype, dest, tag, comm); 43
                44
                45
                /* 5.2: 46
   send the entries of class zero, 47
   preceded by the number of such entries */ 48

```

```

1
2 MPI_Datatype Zparticles, Ztype;
3
4 MPI_Aint      zdisp[1000];
5 int          zblock[1000], i, j, k;
6 int          zzblock[2] = {1,1};
7 MPI_Datatype zztype[2];
8 MPI_Aint      zzdisp[2];
9
10 j=0;
11 for (i=0; i < 1000; i++)
12     if (particle[i].index == 0)
13         {
14             for (k=i+1; (k < 1000)&&(particle[k].index == 0) ; k++);
15             zdisp[j] = i;
16             zblock[j] = k-i;
17             j++;
18             i = k;
19         }
20 MPI_Type_indexed( j, zblock, zdisp, Particletype, &Zparticles);
21 /* Zparticles describe particles with class zero, using
22    their absolute addresses*/
23
24 /* prepend particle count */
25 MPI_Address(&j, zzdisp);
26 zzdisp[1] = MPI_BOTTOM;
27 zztype[0] = MPI_INT;
28 zztype[1] = Zparticles;
29 MPI_Type_struct(2, zzblock, zzdisp, zztype, &Ztype);
30
31 MPI_Type_commit( &Ztype);
32 MPI_Send( MPI_BOTTOM, 1, Ztype, dest, tag, comm);
33
34
35

```

Example 4.19 Handling of unions.

```

36
37 union {
38     int      ival;
39     float    fval;
40     } u[1000];
41
42
43 int      utype;
44
45 /* All entries of u have identical type; variable
46    utype keeps track of their current type */
47
48 MPI_Datatype  type[2];

```

```

int          blocklen[2] = {1,1};          1
MPI_Aint     disp[2];                    2
MPI_Datatype mpi_utype[2];                3
MPI_Aint     i,j;                          4
                                                5
/* compute an MPI datatype for each possible union type; 6
   assume values are left-aligned in union storage. */    7
                                                8

MPI_Address( u, &i);                        9
MPI_Address( u+1, &j);                       10
disp[0] = 0; disp[1] = j-i;                 11
type[1] = MPI_UB;                            12
                                                13

type[0] = MPI_INT;                            14
MPI_Type_struct(2, blocklen, disp, type, &mpi_utype[0]); 15
                                                16

type[0] = MPI_FLOAT;                          17
MPI_Type_struct(2, blocklen, disp, type, &mpi_utype[1]); 18
                                                19

for(i=0; i<2; i++) MPI_Type_commit(&mpi_utype[i]);    20
                                                21

/* actual communication */                    22
                                                23

MPI_Send(u, 1000, mpi_utype[utype], dest, tag, comm); 24
                                                25

Example 4.20 This example shows how a datatype can be decoded. The routine 26
printdatatype prints out the elements of the datatype. Note the use of MPI_Type_free for 27
datatypes that are not predefined.            28
                                                29

/*                                             30
   Example of decoding a datatype.             31
                                                32

   Returns 0 if the datatype is predefined, 1 otherwise 33
*/                                             34

#include <stdio.h>                               35
#include <stdlib.h>                              36
#include "mpi.h"                                 37
int printdatatype( MPI_Datatype datatype )      38
{                                               39
    int *array_of_ints;                          40
    MPI_Aint *array_of_adds;                       41
    MPI_Datatype *array_of_dtypes;                 42
    int num_ints, num_adds, num_dtypes, combiner; 43
    int i;                                         44
                                                45

    MPI_Type_get_envelope( datatype,              46
                           &num_ints, &num_adds, &num_dtypes, &combiner ); 47
    switch (combiner) {                          48

```

```

1   case MPI_COMBINER_NAMED:
2       printf( "Datatype is named:" );
3       /* To print the specific type, we can match against the
4          predefined forms. We can NOT use a switch statement here
5          We could also use MPI_TYPE_GET_NAME if we preferred to use
6          names that the user may have changed.
7          */
8       if      (datatype == MPI_INT)    printf( "MPI_INT\n" );
9       else if (datatype == MPI_DOUBLE) printf( "MPI_DOUBLE\n" );
10      ... else test for other types ...
11      return 0;
12      break;
13  case MPI_COMBINER_STRUCT:
14  case MPI_COMBINER_STRUCT_INTEGER:
15      printf( "Datatype is struct containing" );
16      array_of_ints  = (int *)malloc( num_ints * sizeof(int) );
17      array_of_adds  =
18          (MPI_Aint *) malloc( num_adds * sizeof(MPI_Aint) );
19      array_of_dtypes = (MPI_Datatype *)
20          malloc( num_dtypes * sizeof(MPI_Datatype) );
21      MPI_Type_get_contents( datatype, num_ints, num_adds, num_dtypes,
22          array_of_ints, array_of_adds, array_of_dtypes );
23      printf( " %d datatypes:\n", array_of_ints[0] );
24      for (i=0; i<array_of_ints[0]; i++) {
25          printf( "blocklength %d, displacement %ld, type:\n",
26              array_of_ints[i+1], array_of_adds[i] );
27          if (printdatatype( array_of_dtypes[i] )) {
28              /* Note that we free the type ONLY if it
29                 is not predefined */
30              MPI_Type_free( &array_of_dtypes[i] );
31          }
32      }
33      free( array_of_ints );
34      free( array_of_adds );
35      free( array_of_dtypes );
36      break;
37      ... other combiner values ...
38  default:
39      printf( "Unrecognized combiner type\n" );
40  }
41  return 1;
42  }

```

4.2 Pack and Unpack

Some existing communication libraries provide pack/unpack functions for sending noncontiguous data. In these, the user explicitly packs data into a contiguous buffer before sending

it, and unpacks it from a contiguous buffer after receiving it. Derived datatypes, which are described in Section 4.1, allow one, in most cases, to avoid explicit packing and unpacking. The user specifies the layout of the data to be sent or received, and the communication library directly accesses a noncontiguous buffer. The pack/unpack routines are provided for compatibility with previous libraries. Also, they provide some functionality that is not otherwise available in MPI. For instance, a message can be received in several parts, where the receive operation done on a later part may depend on the content of a former part. Another use is that outgoing messages may be explicitly buffered in user supplied space, thus overriding the system buffering policy. Finally, the availability of pack and unpack operations facilitates the development of additional communication libraries layered on top of MPI.

MPI_PACK(inbuf, incount, datatype, outbuf, outsize, position, comm)

IN	inbuf	input buffer start (choice)
IN	incount	number of input data items (non-negative integer)
IN	datatype	datatype of each input data item (handle)
OUT	outbuf	output buffer start (choice)
IN	outsize	output buffer size, in bytes (non-negative integer)
INOUT	position	current position in buffer, in bytes (integer)
IN	comm	communicator for packed message (handle)

```
int MPI_Pack(const void* inbuf, int incount, MPI_Datatype datatype,
            void *outbuf, int outsize, int *position, MPI_Comm comm)
```

```
MPI_Pack(inbuf, incount, datatype, outbuf, outsize, position, comm, ierror)
```

```
    BIND(C)
```

```
    TYPE(*), DIMENSION(..), INTENT(IN) :: inbuf
```

```
    TYPE(*), DIMENSION(..) :: outbuf
```

```
    INTEGER, INTENT(IN) :: incount, outsize
```

```
    TYPE(MPI_Datatype), INTENT(IN) :: datatype
```

```
    INTEGER, INTENT(INOUT) :: position
```

```
    TYPE(MPI_Comm), INTENT(IN) :: comm
```

```
    INTEGER, OPTIONAL, INTENT(OUT) :: ierror
```

```
MPI_PACK(INBUF, INCOUNT, DATATYPE, OUTBUF, OUTSIZE, POSITION, COMM, IERROR)
```

```
<type> INBUF(*), OUTBUF(*)
```

```
    INTEGER INCOUNT, DATATYPE, OUTSIZE, POSITION, COMM, IERROR
```

```
{void MPI::Datatype::Pack(const void* inbuf, int incount, void *outbuf,
```

```
    int outsize, int& position, const MPI::Comm &comm)
```

```
    const(binding deprecated, see Section 15.2) }
```

Packs the message in the send buffer specified by `inbuf`, `incount`, `datatype` into the buffer space specified by `outbuf` and `outsize`. The input buffer can be any communication buffer allowed in `MPI_SEND`. The output buffer is a contiguous storage area containing `outsize` bytes, starting at the address `outbuf` (length is counted in bytes, not elements, as if it were a communication buffer for a message of type `MPI_PACKED`).

1 The input value of `position` is the first location in the output buffer to be used for
 2 packing. `position` is incremented by the size of the packed message, and the output value
 3 of `position` is the first location in the output buffer following the locations occupied by the
 4 packed message. The `comm` argument is the communicator that will be subsequently used
 5 for sending the packed message.

6
 7
 8 `MPI_UNPACK`(`inbuf`, `insize`, `position`, `outbuf`, `outcount`, `datatype`, `comm`)

9	IN	<code>inbuf</code>	input buffer start (choice)
10	IN	<code>insize</code>	size of input buffer, in bytes (non-negative integer)
11	INOUT	<code>position</code>	current position in bytes (integer)
12	OUT	<code>outbuf</code>	output buffer start (choice)
13	IN	<code>outcount</code>	number of items to be unpacked (integer)
14	IN	<code>datatype</code>	datatype of each output data item (handle)
15	IN	<code>comm</code>	communicator for packed message (handle)

16
 17
 18
 19 `int MPI_Unpack(const void* inbuf, int insize, int *position, void *outbuf,`
 20 `int outcount, MPI_Datatype datatype, MPI_Comm comm)`

21 `MPI_Unpack(inbuf, insize, position, outbuf, outcount, datatype, comm,`
 22 `ierror) BIND(C)`
 23 `TYPE(*), DIMENSION(..), INTENT(IN) :: inbuf`
 24 `TYPE(*), DIMENSION(..) :: outbuf`
 25 `INTEGER, INTENT(IN) :: insize, outcount`
 26 `INTEGER, INTENT(INOUT) :: position`
 27 `TYPE(MPI_Datatype), INTENT(IN) :: datatype`
 28 `TYPE(MPI_Comm), INTENT(IN) :: comm`
 29 `INTEGER, OPTIONAL, INTENT(OUT) :: ierror`

30
 31 `MPI_UNPACK`(`INBUF`, `INSIZE`, `POSITION`, `OUTBUF`, `OUTCOUNT`, `DATATYPE`, `COMM`,
 32 `IERROR`)

33 `<type> INBUF(*), OUTBUF(*)`
 34 `INTEGER INSIZE, POSITION, OUTCOUNT, DATATYPE, COMM, IERROR`

35
 36 `{void MPI::Datatype::Unpack(const void* inbuf, int insize, void *outbuf,`
 37 `int outcount, int& position, const MPI::Comm& comm)`
 38 `const(binding deprecated, see Section 15.2) }`

39 Unpacks a message into the receive buffer specified by `outbuf`, `outcount`, `datatype` from
 40 the buffer space specified by `inbuf` and `insize`. The output buffer can be any communication
 41 buffer allowed in `MPI_RECV`. The input buffer is a contiguous storage area containing `insize`
 42 bytes, starting at address `inbuf`. The input value of `position` is the first location in the input
 43 buffer occupied by the packed message. `position` is incremented by the size of the packed
 44 message, so that the output value of `position` is the first location in the input buffer after
 45 the locations occupied by the message that was unpacked. `comm` is the communicator used
 46 to receive the packed message.

Advice to users. Note the difference between MPI_RECV and MPI_UNPACK: in MPI_RECV, the count argument specifies the maximum number of items that can be received. The actual number of items received is determined by the length of the incoming message. In MPI_UNPACK, the count argument specifies the actual number of items that are unpacked; the “size” of the corresponding message is the increment in position. The reason for this change is that the “incoming message size” is not predetermined since the user decides how much to unpack; nor is it easy to determine the “message size” from the number of items to be unpacked. In fact, in a heterogeneous system, this number may not be determined *a priori*. (*End of advice to users.*)

To understand the behavior of pack and unpack, it is convenient to think of the data part of a message as being the sequence obtained by concatenating the successive values sent in that message. The pack operation stores this sequence in the buffer space, as if sending the message to that buffer. The unpack operation retrieves this sequence from buffer space, as if receiving a message from that buffer. (It is helpful to think of internal Fortran files or `sscanf` in C, for a similar function.)

Several messages can be successively packed into one **packing unit**. This is effected by several successive **related** calls to MPI_PACK, where the first call provides `position = 0`, and each successive call inputs the value of `position` that was output by the previous call, and the same values for `outbuf`, `outcount` and `comm`. This packing unit now contains the equivalent information that would have been stored in a message by one send call with a send buffer that is the “concatenation” of the individual send buffers.

A packing unit can be sent using type MPI_PACKED. Any point to point or collective communication function can be used to move the sequence of bytes that forms the packing unit from one process to another. This packing unit can now be received using any receive operation, with any datatype: the type matching rules are relaxed for messages sent with type MPI_PACKED.

A message sent with any type (including MPI_PACKED) can be received using the type MPI_PACKED. Such a message can then be unpacked by calls to MPI_UNPACK.

A packing unit (or a message created by a regular, “typed” send) can be unpacked into several successive messages. This is effected by several successive related calls to MPI_UNPACK, where the first call provides `position = 0`, and each successive call inputs the value of `position` that was output by the previous call, and the same values for `inbuf`, `insize` and `comm`.

The concatenation of two packing units is not necessarily a packing unit; nor is a substring of a packing unit necessarily a packing unit. Thus, one cannot concatenate two packing units and then unpack the result as one packing unit; nor can one unpack a substring of a packing unit as a separate packing unit. Each packing unit, that was created by a related sequence of pack calls, or by a regular send, must be unpacked as a unit, by a sequence of related unpack calls.

Rationale. The restriction on “atomic” packing and unpacking of packing units allows the implementation to add at the head of packing units additional information, such as a description of the sender architecture (to be used for type conversion, in a heterogeneous environment) (*End of rationale.*)

The following call allows the user to find out how much space is needed to pack a message and, thus, manage space allocation for buffers.

```

1 MPI_PACK_SIZE(incount, datatype, comm, size)
2     IN      incount          count argument to packing call (non-negative integer)
3     IN      datatype        datatype argument to packing call (handle)
4     IN      comm            communicator argument to packing call (handle)
5     OUT     size            upper bound on size of packed message, in bytes (non-
6                             negative integer)
7
8
9

```

```

9 int MPI_Pack_size(int incount, MPI_Datatype datatype, MPI_Comm comm,
10                  int *size)

```

```

11
12 MPI_Pack_size(incount, datatype, comm, size, ierror) BIND(C)
13     INTEGER, INTENT(IN) :: incount
14     TYPE(MPI_Datatype), INTENT(IN) :: datatype
15     TYPE(MPI_Comm), INTENT(IN) :: comm
16     INTEGER, INTENT(OUT) :: size
17     INTEGER, OPTIONAL, INTENT(OUT) :: ierror
18

```

```

19 MPI_PACK_SIZE(INCOUNT, DATATYPE, COMM, SIZE, IERROR)
20     INTEGER INCOUNT, DATATYPE, COMM, SIZE, IERROR

```

```

21 {int MPI::Datatype::Pack_size(int incount, const MPI::Comm& comm)
22     const(binding deprecated, see Section 15.2) }
23

```

A call to `MPI_PACK_SIZE(incount, datatype, comm, size)` returns in `size` an upper bound on the increment in position that is effected by a call to `MPI_PACK(inbuf, incount, datatype, outbuf, outcount, position, comm)`. *If the packed size of the datatype cannot be expressed by the `size` parameter, then `MPI_PACK_SIZE` sets the value of `size` to `MPI_UNDEFINED`.*

Rationale. The call returns an upper bound, rather than an exact bound, since the exact amount of space needed to pack the message may depend on the context (e.g., first message packed in a packing unit may take more space). (*End of rationale.*)

Example 4.21 An example using `MPI_PACK`.

```

34 int      position, i, j, a[2];
35 char     buff[1000];
36
37 MPI_Comm_rank(MPI_COMM_WORLD, &myrank);
38 if (myrank == 0)
39 {
40     /* SENDER CODE */
41
42     position = 0;
43     MPI_Pack(&i, 1, MPI_INT, buff, 1000, &position, MPI_COMM_WORLD);
44     MPI_Pack(&j, 1, MPI_INT, buff, 1000, &position, MPI_COMM_WORLD);
45     MPI_Send( buff, position, MPI_PACKED, 1, 0, MPI_COMM_WORLD);
46 }
47 else /* RECEIVER CODE */
48     MPI_Recv( a, 2, MPI_INT, 0, 0, MPI_COMM_WORLD);

```

Example 4.22 An elaborate example.

```
1
2
3
4
5
6
7
8
9
10
11
12
13
14
15
16
17
18
19
20
21
22
23
24
25
26
27
28
29
30
31
32
33
34
35
36
37
38
39
40
41
42
43
44
45
46
47
48

int  position, i;
float a[1000];
char  buff[1000];

MPI_Comm_rank(MPI_Comm_world, &myrank);
if (myrank == 0)
{
    /* SENDER CODE */

    int len[2];
    MPI_Aint disp[2];
    MPI_Datatype type[2], newtype;

    /* build datatype for i followed by a[0]...a[i-1] */

    len[0] = 1;
    len[1] = i;
    MPI_Address( &i, disp);
    MPI_Address( a, disp+1);
    type[0] = MPI_INT;
    type[1] = MPI_FLOAT;
    MPI_Type_struct( 2, len, disp, type, &newtype);
    MPI_Type_commit( &newtype);

    /* Pack i followed by a[0]...a[i-1]*/

    position = 0;
    MPI_Pack( MPI_BOTTOM, 1, newtype, buff, 1000, &position, MPI_COMM_WORLD);

    /* Send */

    MPI_Send( buff, position, MPI_PACKED, 1, 0,
              MPI_COMM_WORLD);

    /* *****
       One can replace the last three lines with
       MPI_Send( MPI_BOTTOM, 1, newtype, 1, 0, MPI_COMM_WORLD);
       ***** */
}
else if (myrank == 1)
{
    /* RECEIVER CODE */

    MPI_Status status;

    /* Receive */
```

```

1
2 MPI_Recv( buff, 1000, MPI_PACKED, 0, 0, MPI_COMM_WORLD, &status);
3
4 /* Unpack i */
5
6 position = 0;
7 MPI_Unpack(buff, 1000, &position, &i, 1, MPI_INT, MPI_COMM_WORLD);
8
9 /* Unpack a[0]...a[i-1] */
10 MPI_Unpack(buff, 1000, &position, a, i, MPI_FLOAT, MPI_COMM_WORLD);
11 }
12

```

Example 4.23 Each process sends a count, followed by count characters to the root; the root concatenates all characters into one string.

```

13
14
15
16 int count, gsize, counts[64], totalcount, k1, k2, k,
17     displs[64], position, concat_pos;
18 char chr[100], *lbuf, *rbuf, *cbuf;
19
20 MPI_Comm_size(comm, &gsize);
21 MPI_Comm_rank(comm, &myrank);
22
23     /* allocate local pack buffer */
24 MPI_Pack_size(1, MPI_INT, comm, &k1);
25 MPI_Pack_size(count, MPI_CHAR, comm, &k2);
26 k = k1+k2;
27 lbuf = (char *)malloc(k);
28
29     /* pack count, followed by count characters */
30 position = 0;
31 MPI_Pack(&count, 1, MPI_INT, lbuf, k, &position, comm);
32 MPI_Pack(chr, count, MPI_CHAR, lbuf, k, &position, comm);
33
34 if (myrank != root) {
35     /* gather at root sizes of all packed messages */
36     MPI_Gather( &position, 1, MPI_INT, NULL, 0,
37               MPI_DATATYPE_NULL, root, comm);
38
39     /* gather at root packed messages */
40     MPI_Gatherv( lbuf, position, MPI_PACKED, NULL,
41                NULL, NULL, NULL, root, comm);
42
43 } else { /* root code */
44     /* gather sizes of all packed messages */
45     MPI_Gather( &position, 1, MPI_INT, counts, 1,
46               MPI_INT, root, comm);
47
48     /* gather all packed messages */

```

```

displs[0] = 0;
for (i=1; i < gsize; i++)
    displs[i] = displs[i-1] + counts[i-1];
totalcount = displs[gsiz-1] + counts[gsiz-1];
rbuf = (char *)malloc(totalcount);
cbuf = (char *)malloc(totalcount);
MPI_Gatherv( lbuf, position, MPI_PACKED, rbuf,
             counts, displs, MPI_PACKED, root, comm);

    /* unpack all messages and concatenate strings */
concat_pos = 0;
for (i=0; i < gsize; i++) {
    position = 0;
    MPI_Unpack( rbuf+displs[i], totalcount-displs[i],
                &position, &count, 1, MPI_INT, comm);
    MPI_Unpack( rbuf+displs[i], totalcount-displs[i],
                &position, cbuf+concat_pos, count, MPI_CHAR, comm);
    concat_pos += count;
}
cbuf[concat_pos] = '\0';
}

```

4.3 Canonical MPI_PACK and MPI_UNPACK

These functions read/write data to/from the buffer in the “external32” data format specified in Section 13.5.2, and calculate the size needed for packing. Their first arguments specify the data format, for future extensibility, but currently the only valid value of the `datarep` argument is “external32.”

Advice to users. These functions could be used, for example, to send typed data in a portable format from one MPI implementation to another. (*End of advice to users.*)

The buffer will contain exactly the packed data, without headers. `MPI_BYTE` should be used to send and receive data that is packed using `MPI_PACK_EXTERNAL`.

Rationale. `MPI_PACK_EXTERNAL` specifies that there is no header on the message and further specifies the exact format of the data. Since `MPI_PACK` may (and is allowed to) use a header, the datatype `MPI_PACKED` cannot be used for data packed with `MPI_PACK_EXTERNAL`. (*End of rationale.*)

```

1 MPI_PACK_EXTERNAL(datarep, inbuf, incount, datatype, outbuf, outsize, position )
2     IN      datarep          data representation (string)
3
4     IN      inbuf           input buffer start (choice)
5
6     IN      incount         number of input data items (integer)
7
8     IN      datatype        datatype of each input data item (handle)
9
10    OUT     outbuf          output buffer start (choice)
11
12    IN      outsize         output buffer size, in bytes (integer)
13
14    INOUT   position        current position in buffer, in bytes (integer)
15
16 int MPI_Pack_external(const char *datarep, const void *inbuf, int incount,
17                      MPI_Datatype datatype, void *outbuf, MPI_Aint outsize,
18                      MPI_Aint *position)
19
20 MPI_Pack_external(datarep, inbuf, incount, datatype, outbuf, outsize,
21                  position, ierror) BIND(C)
22
23 CHARACTER(LEN=*), INTENT(IN) :: datarep
24 TYPE(*), DIMENSION(..), INTENT(IN) :: inbuf
25 TYPE(*), DIMENSION(..) :: outbuf
26 INTEGER, INTENT(IN) :: incount
27 TYPE(MPI_Datatype), INTENT(IN) :: datatype
28 INTEGER(KIND=MPI_ADDRESS_KIND), INTENT(IN) :: outsize
29 INTEGER(KIND=MPI_ADDRESS_KIND), INTENT(INOUT) :: position
30 INTEGER, OPTIONAL, INTENT(OUT) :: ierror
31
32 MPI_PACK_EXTERNAL(DATAREP, INBUF, INCOUNT, DATATYPE, OUTBUF, OUTSIZE,
33                   POSITION, IERROR)
34
35 INTEGER INCOUNT, DATATYPE, IERROR
36 INTEGER(KIND=MPI_ADDRESS_KIND) OUTSIZE, POSITION
37 CHARACTER*(*) DATAREP
38 <type> INBUF(*), OUTBUF(*)
39
40 {void MPI::Datatype::Pack_external(const char* datarep, const void* inbuf,
41                                   int incount, void* outbuf, MPI::Aint outsize,
42                                   MPI::Aint& position) const(binding deprecated, see Section 15.2) }
43
44
45
46
47
48

```

```

MPI_UNPACK_EXTERNAL(datarep, inbuf, insize, position, outbuf, outsize, position )
1
IN      datarep          data representation (string)
2
IN      inbuf            input buffer start (choice)
3
IN      insize           input buffer size, in bytes (integer)
4
INOUT   position        current position in buffer, in bytes (integer)
5
OUT     outbuf           output buffer start (choice)
6
IN      outcount        number of output data items (integer)
7
IN      datatype        datatype of output data item (handle)
8
9
10
11
12
int MPI_Unpack_external(const char *datarep, const void *inbuf,
13 ticket140.
    MPI_Aint insize, MPI_Aint *position, void *outbuf,
14 ticket140.
    int outcount, MPI_Datatype datatype)
15 ticket-248T.
MPI_Unpack_external(datarep, inbuf, insize, position, outbuf, outcount,
16
    datatype, ierror) BIND(C)
17
    CHARACTER(LEN=*), INTENT(IN) :: datarep
18
    TYPE(*), DIMENSION(..), INTENT(IN) :: inbuf
19
    TYPE(*), DIMENSION(..) :: outbuf
20
    INTEGER(KIND=MPI_ADDRESS_KIND), INTENT(IN) :: insize
21
    INTEGER(KIND=MPI_ADDRESS_KIND), INTENT(INOUT) :: position
22
    INTEGER, INTENT(IN) :: outcount
23
    TYPE(MPI_Datatype), INTENT(IN) :: datatype
24
    INTEGER, OPTIONAL, INTENT(OUT) :: ierror
25
26
MPI_UNPACK_EXTERNAL(DATAREP, INBUF, INSIZE, POSITION, OUTBUF, OUTCOUNT,
27
    DATATYPE, IERROR)
28
    INTEGER OUTCOUNT, DATATYPE, IERROR
29
    INTEGER(KIND=MPI_ADDRESS_KIND) INSIZE, POSITION
30
    CHARACTER*(*) DATAREP
31
    <type> INBUF(*), OUTBUF(*)
32
33
{void MPI::Datatype::Unpack_external(const char* datarep,
34
    const void* inbuf, MPI::Aint insize, MPI::Aint& position,
35
    void* outbuf, int outcount) const (binding deprecated, see
36
    Section 15.2) }
37
38
39
MPI_PACK_EXTERNAL_SIZE( datarep, incount, datatype, size )
40
IN      datarep          data representation (string)
41
IN      incount          number of input data items (integer)
42
IN      datatype        datatype of each input data item (handle)
43
OUT     size             output buffer size, in bytes (integer)
44
45
46
int MPI_Pack_external_size(const char *datarep, int incount,
47 ticket140.
    MPI_Datatype datatype, MPI_Aint *size)
48

```

```

1
2 MPI_Pack_external_size(datarep, incount, datatype, size, ierror) BIND(C)
3     TYPE(MPI_Datatype), INTENT(IN) :: datatype
4     INTEGER, INTENT(IN) :: incount
5     CHARACTER(LEN=*), INTENT(IN) :: datarep
6     INTEGER(KIND=MPI_ADDRESS_KIND), INTENT(OUT) :: size
7     INTEGER, OPTIONAL, INTENT(OUT) :: ierror
8
9 MPI_PACK_EXTERNAL_SIZE(DATAREP, INCOUNT, DATATYPE, SIZE, IERROR)
10    INTEGER INCOUNT, DATATYPE, IERROR
11    INTEGER(KIND=MPI_ADDRESS_KIND) SIZE
12    CHARACTER*(*) DATAREP
13
14 {MPI::Aint MPI::Datatype::Pack_external_size(const char* datarep,
15     int incount) const(binding deprecated, see Section 15.2) }
16
17
18
19
20
21
22
23
24
25
26
27
28
29
30
31
32
33
34
35
36
37
38
39
40
41
42
43
44
45
46
47
48

```

Chapter 5

Collective Communication

5.1 Introduction and Overview

Collective communication is defined as communication that involves a group or groups of processes. The functions of this type provided by MPI are the following:

- **MPI_BARRIER**, **MPI_IBARRIER**: Barrier synchronization across all members of a group (Section 5.3 and Section 5.12.1).
- **MPI_BCAST**, **MPI_IBCAST**: Broadcast from one member to all members of a group (Section 5.4 and Section 5.12.2). This is shown as “broadcast” in Figure 5.1.
- **MPI_GATHER**, **MPI_IGATHER**, **MPI_GATHERV**, **MPI_IGATHERV**: Gather data from all members of a group to one member (Section 5.5 and Section 5.12.3). This is shown as “gather” in Figure 5.1.
- **MPI_SCATTER**, **MPI_ISCATTER**, **MPI_SCATTERV**, **MPI_ISCATTERV**: Scatter data from one member to all members of a group (Section 5.6 and Section 5.12.4). This is shown as “scatter” in Figure 5.1.
- **MPI_ALLGATHER**, **MPI_IALLGATHER**, **MPI_ALLGATHERV**, **MPI_IALLGATHERV**: A variation on Gather where all members of a group receive the result (Section 5.7 and Section 5.12.5). This is shown as “allgather” in Figure 5.1.
- **MPI_ALLTOALL**, **MPI_IALLTOALL**, **MPI_ALLTOALLV**, **MPI_IALLTOALLV**, **MPI_ALLTOALLW**, **MPI_IALLTOALLW**: Scatter/Gather data from all members to all members of a group (also called complete exchange) (Section 5.8 and Section 5.12.6). This is shown as “complete exchange” in Figure 5.1.
- **MPI_ALLREDUCE**, **MPI_IALLREDUCE**, **MPI_REDUCE**, **MPI_IREDUCE**: Global reduction operations such as sum, max, min, or user-defined functions, where the result is returned to all members of a group (Section 5.9.6 and Section 5.12.8) and a variation where the result is returned to only one member (Section 5.9 and Section 5.12.7).
- **MPI_REDUCE_SCATTER_BLOCK**, **MPI_IREDUCE_SCATTER_BLOCK**, **MPI_REDUCE_SCATTER**, **MPI_IREDUCE_SCATTER**: A combined reduction and scatter operation (Section 5.10, Section 5.12.9, and Section 5.12.10).

- `MPI_SCAN`, `MPI_ISCAN`, `MPI_EXSCAN`, `MPI_IEXSCAN`: Scan across all members of a group (also called prefix) (Section 5.11, Section 5.11.2, Section 5.12.11, and Section 5.12.12).

ticket109.
ticket109.
ticket109.

One of the key arguments in a call to a collective routine is a communicator that defines the group or groups of participating processes and provides a context for the operation. This is discussed further in Section 5.2. The syntax and semantics of the collective operations are defined to be consistent with the syntax and semantics of the point-to-point operations. Thus, general datatypes are allowed and must match between sending and receiving processes as specified in Chapter 4. Several collective routines such as broadcast and gather have a single originating or receiving process. Such a process is called the *root*. Some arguments in the collective functions are specified as “significant only at root,” and are ignored for all participants except the root. The reader is referred to Chapter 4 for information concerning communication buffers, general datatypes and type matching rules, and to Chapter 6 for information on how to define groups and create communicators.

The type-matching conditions for the collective operations are more strict than the corresponding conditions between sender and receiver in point-to-point. Namely, for collective operations, the amount of data sent must exactly match the amount of data specified by the receiver. Different type maps (the layout in memory, see Section 4.1) between sender and receiver are still allowed.

Collective [routine calls]operations can (but are not required to) [return]complete as soon as [their]the caller’s participation in the collective communication is [complete]finished. A blocking operation is complete as soon as the call returns. A nonblocking (immediate) call requires a separate completion call (cf. Section 3.7). The completion of a [call]collective operation indicates that the caller is [now] free to modify locations in the communication buffer. It does not indicate that other processes in the group have completed or even started the operation (unless otherwise implied by the description of the operation). [Thus, a collective communication call may, or may not, have the effect of synchronizing all calling processes. This statement excludes, of course, the barrier function]Thus, a collective communication operation may, or may not, have the effect of synchronizing all calling processes. This statement excludes, of course, the barrier operation.

Collective communication calls may use the same communicators as point-to-point communication; MPI guarantees that messages generated on behalf of collective communication calls will not be confused with messages generated by point-to-point communication. The collective operations do not have a message tag argument. A more detailed discussion of correct use of collective routines is found in Section 5.13.

Rationale. The equal-data restriction (on type matching) was made so as to avoid the complexity of providing a facility analogous to the status argument of `MPI_RECV` for discovering the amount of data sent. Some of the collective routines would require an array of status values.

The statements about synchronization are made so as to allow a variety of implementations of the collective functions.

[The collective operations do not accept a message tag argument. If future revisions of MPI define nonblocking collective functions, then tags (or a similar mechanism) might need to be added so as to allow the dis-ambiguation of multiple, pending, collective operations.] (*End of rationale.*)

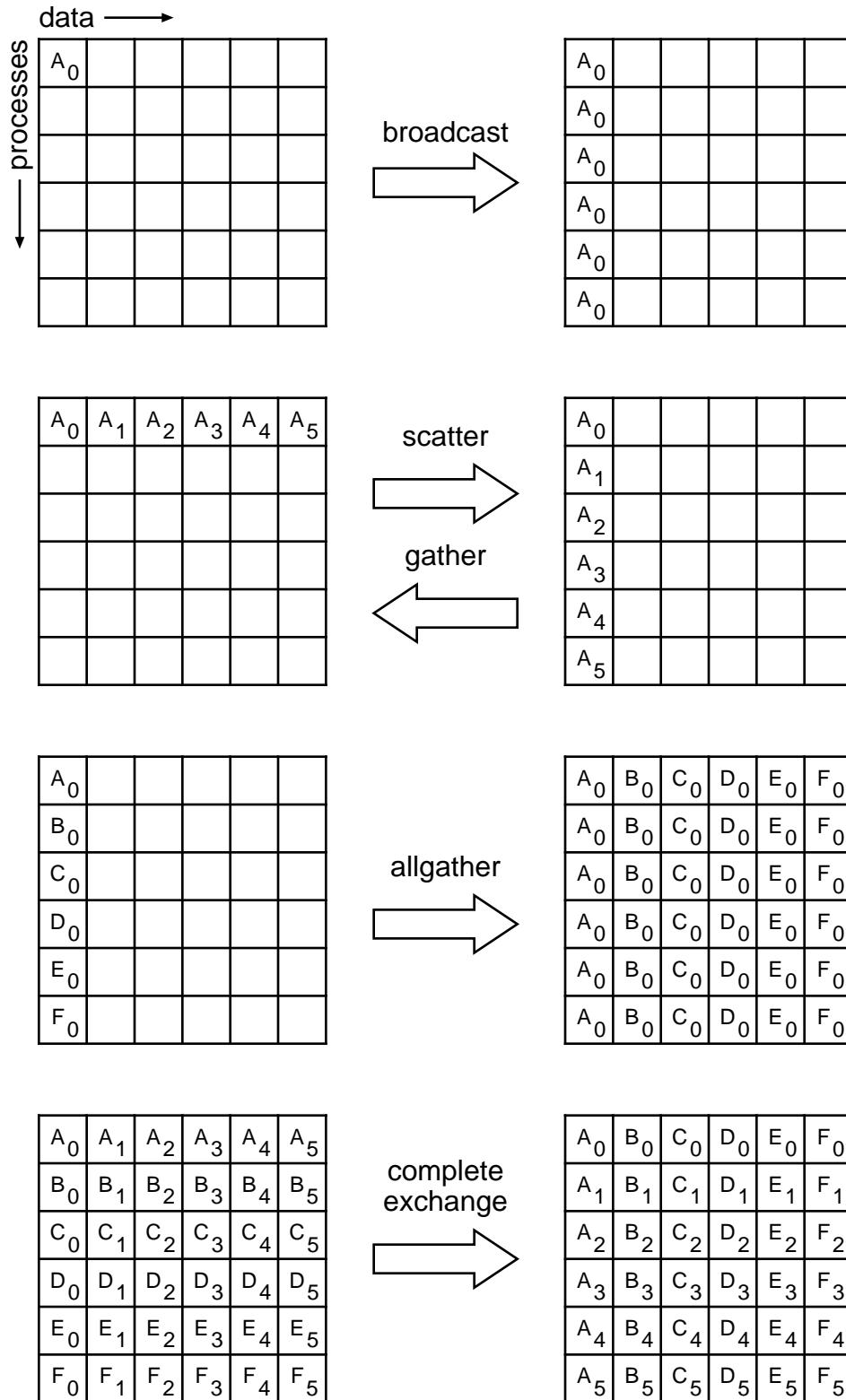

Figure 5.1: Collective move functions illustrated for a group of six processes. In each case, each row of boxes represents data locations in one process. Thus, in the broadcast, initially just the first process contains the data A_0 , but after the broadcast all processes contain it.

1
2
3
4
5
6
7
8
9
10
11
12
13
14
15
16
17
18
19
20
21
22
23
24
25
26
27
28
29
30
31
32
33
34
35
36
37
38
39
40
41
42
43
44
45
46
47
48

1 *Advice to users.* It is dangerous to rely on synchronization side-effects of the col-
 2 lective operations for program correctness. For example, even though a particular
 3 implementation may provide a broadcast routine with a side-effect of synchroniza-
 4 tion, the standard does not require this, and a program that relies on this will not be
 5 portable.

6 On the other hand, a correct, portable program must allow for the fact that a collective
 7 call *may* be synchronizing. Though one cannot rely on any synchronization side-effect,
 8 one must program so as to allow it. These issues are discussed further in Section 5.13.
 9 (*End of advice to users.*)

10
 11 *Advice to implementors.* While vendors may write optimized collective routines
 12 matched to their architectures, a complete library of the collective communication
 13 routines can be written entirely using the MPI point-to-point communication func-
 14 tions and a few auxiliary functions. If implementing on top of point-to-point, a hidden,
 15 special communicator might be created for the collective operation so as to avoid inter-
 16 ference with any on-going point-to-point communication at the time of the collective
 17 call. This is discussed further in Section 5.13. (*End of advice to implementors.*)

18 Many of the descriptions of the collective routines provide illustrations in terms of
 19 blocking MPI point-to-point routines. These are intended solely to indicate what data is
 20 sent or received by what process. Many of these examples are *not* correct MPI programs;
 21 for purposes of simplicity, they often assume infinite buffering.
 22

23 5.2 Communicator Argument

24 The key concept of the collective functions is to have a group or groups of participating
 25 processes. The routines do not have group identifiers as explicit arguments. Instead, there
 26 is a communicator argument. Groups and communicators are discussed in full detail in
 27 Chapter 6. For the purposes of this chapter, it is sufficient to know that there are two types
 28 of communicators: *intra-communicators* and *inter-communicators*. An intracommunicator
 29 can be thought of as an i[n]dentifier for a single group of processes linked with a context.
 30 An intercommunicator identifies two distinct groups of processes linked with a context.
 31

32 5.2.1 Specifics for Intracommunicator Collective Operations

33 All processes in the group identified by the intracommunicator must call the collective
 34 routine.

35 In many cases, collective communication can occur “in place” for intracommunicators,
 36 with the output buffer being identical to the input buffer. This is specified by providing
 37 a special argument value, MPI_IN_PLACE, instead of the send buffer or the receive buffer
 38 argument, depending on the operation performed.
 39

40
 41 *Rationale.* The “in place” operations are provided to reduce unnecessary memory
 42 motion by both the MPI implementation and by the user. Note that while the simple
 43 check of testing whether the send and receive buffers have the same address will
 44 work for some cases (e.g., MPI_ALLREDUCE), they are inadequate in others (e.g.,
 45 MPI_GATHER, with root not equal to zero). Further, Fortran explicitly prohibits
 46 aliasing of arguments; the approach of using a special value to denote “in place”
 47 operation eliminates that difficulty. (*End of rationale.*)
 48

Advice to users. By allowing the “in place” option, the receive buffer in many of the collective calls becomes a send-and-receive buffer. For this reason, a Fortran binding that includes INTENT must mark these as INOUT, not OUT.

Note that MPI_IN_PLACE is a special kind of value; it has the same restrictions on its use that MPI_BOTTOM has. [[Some intracommunicator collective operations do not support the “in place” option \(e.g., MPI_ALLTOALLV\)](#).] (*End of advice to users.*)

5.2.2 Applying Collective Operations to Intercommunicators

To understand how collective operations apply to intercommunicators, we can view most MPI intracommunicator collective operations as fitting one of the following categories (see, for instance, [56]):

All-To-All All processes contribute to the result. All processes receive the result.

- MPI_ALLGATHER, MPI_IALLGATHER, MPI_ALLGATHERV, MPI_IALLGATHERV
- MPI_ALLTOALL, MPI_IALLTOALL, MPI_ALLTOALLV, MPI_IALLTOALLV, MPI_ALLTOALLW, MPI_IALLTOALLW
- MPI_ALLREDUCE, MPI_IALLREDUCE, MPI_REDUCE_SCATTER_BLOCK, MPI_IREDUCE_SCATTER_BLOCK, MPI_REDUCE_SCATTER, MPI_IREDUCE_SCATTER
- MPI_BARRIER, MPI_IBARRIER

All-To-One All processes contribute to the result. One process receives the result.

- MPI_GATHER, MPI_IGATHER, MPI_GATHERV, MPI_IGATHERV
- MPI_REDUCE, MPI_IREDUCE

One-To-All One process contributes to the result. All processes receive the result.

- MPI_BCAST, MPI_IBCAST
- MPI_SCATTER, MPI_ISCATTER, MPI_SCATTERV, MPI_ISCATTERV

Other Collective operations that do not fit into one of the above categories.

- MPI_SCAN, MPI_ISCAN, MPI_EXSCAN, MPI_IEXSCAN

The data movement patterns of MPI_SCAN, MPI_ISCAN [and], MPI_EXSCAN, and MPI_IEXSCAN do not fit this taxonomy.

The application of collective communication to intercommunicators is best described in terms of two groups. For example, an all-to-all MPI_ALLGATHER operation can be described as collecting data from all members of one group with the result appearing in all members of the other group (see Figure 5.2). As another example, a one-to-all MPI_BCAST operation sends data from one member of one group to all members of the other group. Collective computation operations such as MPI_REDUCE_SCATTER have a similar interpretation (see Figure 5.3). For intracommunicators, these two groups are the same. For intercommunicators, these two groups are distinct. For the all-to-all operations, each such operation is described in two phases, so that it has a symmetric, full-duplex behavior.

The following collective operations also apply to intercommunicators:

- ticket109. 1 • MPI_BARRIER, MPI_IBARRIER
- ticket109. 2
- ticket109. 3 • MPI_BCAST, MPI_IBCAST
- ticket109. 4
- ticket109. 5 • MPI_GATHER, MPI_IGATHER, MPI_GATHERV, MPI_IGATHERV,
- ticket109. 6 • MPI_SCATTER, MPI_ISCATTER, MPI_SCATTERV, MPI_ISCATTERV,
- ticket109. 7 • MPI_ALLGATHER, MPI_IALLGATHER, MPI_ALLGATHERV, MPI_IALLGATHERV,
- ticket109. 8
- ticket109. 9 • MPI_ALLTOALL, MPI_IALLTOALL, MPI_ALLTOALLV, MPI_IALLTOALLV,
- ticket109. 10 MPI_ALLTOALLW, MPI_IALLTOALLW,
- ticket109. 11
- ticket109. 12 • MPI_ALLREDUCE, MPI_IALLREDUCE, MPI_REDUCE, MPI_IREDUCE,
- ticket109. 13
- ticket109. 14 • MPI_REDUCE_SCATTER_BLOCK, MPI_IREDUCE_SCATTER_BLOCK,
- ticket109. 15 MPI_REDUCE_SCATTER, MPI_IREDUCE_SCATTER.
- ticket109. 16

In C++, the bindings for these functions are in the `MPI::Comm` class. However, since the collective operations do not make sense on a C++ `MPI::Comm` (as it is neither an intercommunicator nor an intracommunicator), the functions are all pure virtual.

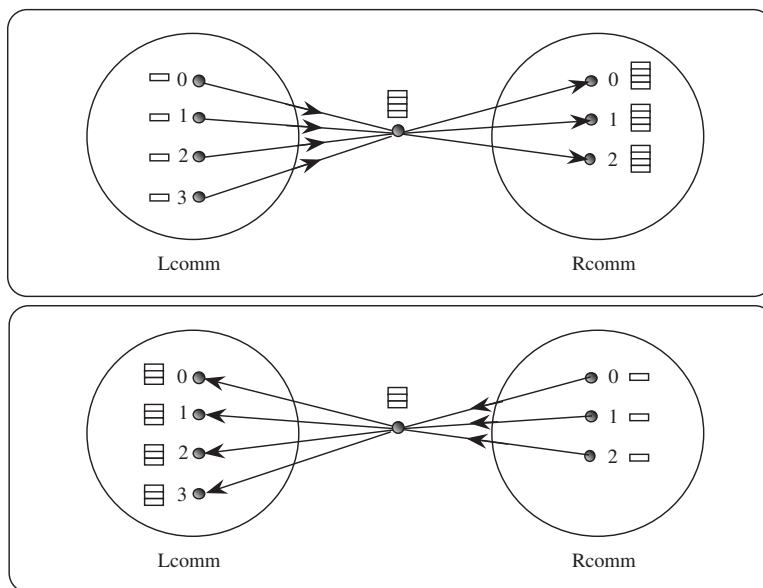

Figure 5.2: Intercommunicator allgather. The focus of data to one process is represented, not mandated by the semantics. The two phases do allgathers in both directions.

5.2.3 Specifics for Intercommunicator Collective Operations

All processes in both groups identified by the intercommunicator must call the collective routine.

Note that the “in place” option for intracommunicators does not apply to intercommunicators since in the intercommunicator case there is no communication from a process to itself.

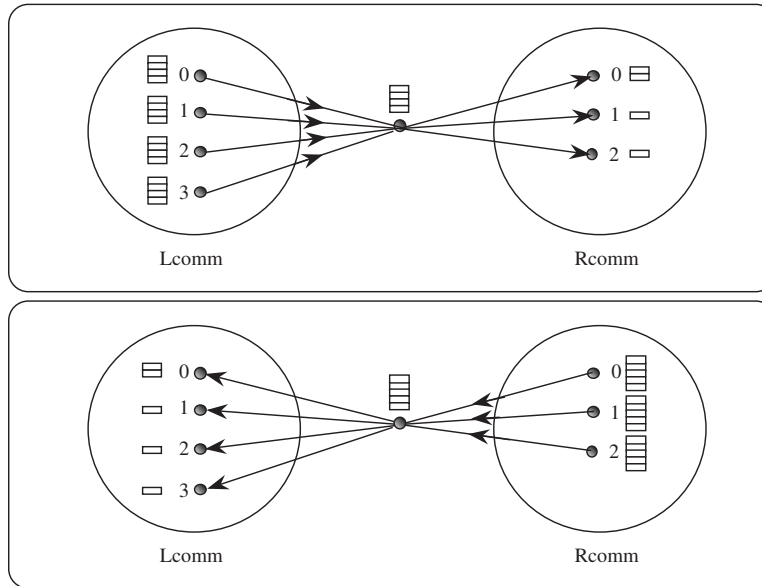

Figure 5.3: Intercommunicator reduce-scatter. The focus of data to one process is represented, not mandated by the semantics. The two phases do reduce-scatters in both directions.

For intercommunicator collective communication, if the operation is in the All-To-One or One-To-All categories, then the transfer is unidirectional. The direction of the transfer is indicated by a special value of the root argument. In this case, for the group containing the root process, all processes in the group must call the routine using a special argument for the root. For this, the root process uses the special root value `MPI_ROOT`; all other processes in the same group as the root use `MPI_PROC_NULL`. All processes in the other group (the group that is the remote group relative to the root process) must call the collective routine and provide the rank of the root. If the operation is in the All-To-All category, then the transfer is bidirectional.

Rationale. Operations in the All-To-One and One-To-All categories are unidirectional by nature, and there is a clear way of specifying direction. Operations in the All-To-All category will often occur as part of an exchange, where it makes sense to communicate in both directions at once. (*End of rationale.*)

5.3 Barrier Synchronization

`MPI_BARRIER(comm)`

IN `comm` communicator (handle)

`int MPI_Barrier(MPI_Comm comm)`

`MPI_Barrier(comm, ierror) BIND(C)`
`TYPE(MPI_Comm), INTENT(IN) :: comm`

1 **INTEGER, OPTIONAL, INTENT(OUT) :: ierror**

2
3 MPI_BARRIER(COMM, IERROR)
4 INTEGER COMM, IERROR

5 {void MPI::Comm::Barrier() const = 0(*binding deprecated, see Section 15.2*) }

6
7 If comm is an intracommunicator, MPI_BARRIER blocks the caller until all group mem-
8 bers have called it. The call returns at any process only after all group members have entered
9 the call.

10 If comm is an intercommunicator, MPI_BARRIER involves two groups. The call returns
11 at processes in one group (group A) of the intercommunicator only after all members of the
12 other group (group B) have entered the call (and vice versa). A process may return from
13 the call before all processes in its own group have entered the call.

14 5.4 Broadcast

15
16
17
18 MPI_BCAST(buffer, count, datatype, root, comm)

19	INOUT	buffer	starting address of buffer (choice)
20	IN	count	number of entries in buffer (non-negative integer)
21	IN	datatype	data type of buffer (handle)
22	IN	root	rank of broadcast root (integer)
23	IN	comm	communicator (handle)

24
25
26
27
28 int MPI_Bcast(void* buffer, int count, MPI_Datatype datatype, int root,
29 MPI_Comm comm)

30 **MPI_Bcast(buffer, count, datatype, root, comm, ierror) BIND(C)**
31 **TYPE(*), DIMENSION(..) :: buffer**
32 **INTEGER, INTENT(IN) :: count, root**
33 **TYPE(MPI_Datatype), INTENT(IN) :: datatype**
34 **TYPE(MPI_Comm), INTENT(IN) :: comm**
35 **INTEGER, OPTIONAL, INTENT(OUT) :: ierror**

36
37 MPI_BCAST(BUFFER, COUNT, DATATYPE, ROOT, COMM, IERROR)
38 <type> BUFFER(*)
39 INTEGER COUNT, DATATYPE, ROOT, COMM, IERROR

40 {void MPI::Comm::Bcast(void* buffer, int count,
41 const MPI::Datatype& datatype, int root) const = 0(*binding*
42 *deprecated, see Section 15.2*) }

43
44 If comm is an intracommunicator, MPI_BCAST broadcasts a message from the process
45 with rank root to all processes of the group, itself included. It is called by all members of
46 the group using the same arguments for comm and root. On return, the content of root's
47 buffer is copied to all other processes.

48

General, derived datatypes are allowed for `datatype`. The type signature of `count`, `datatype` on any process must be equal to the type signature of `count`, `datatype` at the root. This implies that the amount of data sent must be equal to the amount received, pairwise between each process and the root. `MPI_BCAST` and all other data-movement collective routines make this restriction. Distinct type maps between sender and receiver are still allowed.

The “in place” option is not meaningful here.

If `comm` is an intercommunicator, then the call involves all processes in the intercommunicator, but with one group (group A) defining the root process. All processes in the other group (group B) pass the same value in argument `root`, which is the rank of the root in group A. The root passes the value `MPI_ROOT` in `root`. All other processes in group A pass the value `MPI_PROC_NULL` in `root`. Data is broadcast from the root to all processes in group B. The buffer arguments of the processes in group B must be consistent with the buffer argument of the root.

5.4.1 Example using `MPI_BCAST`

The examples in this section use intracommunicators.

Example 5.1

Broadcast 100 ints from process 0 to every process in the group.

```
MPI_Comm comm;
int array[100];
int root=0;
...
MPI_Bcast(array, 100, MPI_INT, root, comm);
```

As in many of our example code fragments, we assume that some of the variables (such as `comm` in the above) have been assigned appropriate values.

5.5 Gather

1	MPI_GATHER(sendbuf, sendcount, sendtype, recvbuf, recvcount, recvtype, root, comm)		
2			
3			
4			
5			
6	IN	sendbuf	starting address of send buffer (choice)
7	IN	sendcount	number of elements in send buffer (non-negative integer)
8			
9	IN	sendtype	data type of send buffer elements (handle)
10	OUT	recvbuf	address of receive buffer (choice, significant only at root)
11			
12			
13	IN	recvcount	number of elements for any single receive (non-negative integer, significant only at root)
14			
15	IN	recvtype	data type of recv buffer elements (significant only at root) (handle)
16			
17			
18	IN	root	rank of receiving process (integer)
19	IN	comm	communicator (handle)
20			

```

21 int MPI_Gather(const void* sendbuf, int sendcount, MPI_Datatype sendtype,
22              void* recvbuf, int recvcount, MPI_Datatype recvtype, int root,
23              MPI_Comm comm)

```

```

24 MPI_Gather(sendbuf, sendcount, sendtype, recvbuf, recvcount, recvtype,
25           root, comm, ierror) BIND(C)
26           TYPE(*), DIMENSION(..), INTENT(IN) :: sendbuf
27           TYPE(*), DIMENSION(..) :: recvbuf
28           INTEGER, INTENT(IN) :: sendcount, recvcount, root
29           TYPE(MPI_Datatype), INTENT(IN) :: sendtype, recvtype
30           TYPE(MPI_Comm), INTENT(IN) :: comm
31           INTEGER, OPTIONAL, INTENT(OUT) :: ierror

```

```

32 MPI_GATHER(SENDBUF, SENDCOUNT, SENDTYPE, RECVBUF, RECVCOUNT, RECVTYPE,
33           ROOT, COMM, IERROR)
34           <type> SENDBUF(*), RECVBUF(*)
35           INTEGER SENDCOUNT, SENDTYPE, RECVCOUNT, RECVTYPE, ROOT, COMM, IERROR

```

```

36 {void MPI::Comm::Gather(const void* sendbuf, int sendcount, const
37                       MPI::Datatype& sendtype, void* recvbuf, int recvcount,
38                       const MPI::Datatype& recvtype, int root) const = 0(binding
39                       deprecated, see Section 15.2) }

```

If `comm` is an intracommunicator, each process (root process included) sends the contents of its send buffer to the root process. The root process receives the messages and stores them in rank order. The outcome is *as if* each of the `n` processes in the group (including the root process) had executed a call to

```
MPI_Send(sendbuf, sendcount, sendtype, root, ...),
```

and the root had executed `n` calls to

```
MPI_Recv(recvbuf + i · recvcount · extent(recvtype), recvcount, recvtype, i, ...),
```

where `extent(recvtype)` is the type extent obtained from a call to `MPI_Type_get_extent()`.

An alternative description is that the `n` messages sent by the processes in the group are concatenated in rank order, and the resulting message is received by the root as if by a call to `MPI_RECV(recvbuf, recvcount·n, recvtype, ...)`.

The receive buffer is ignored for all non-root processes.

General, derived datatypes are allowed for both `sendtype` and `recvtype`. The type signature of `sendcount`, `sendtype` on each process must be equal to the type signature of `recvcount`, `recvtype` at the root. This implies that the amount of data sent must be equal to the amount of data received, pairwise between each process and the root. Distinct type maps between sender and receiver are still allowed.

All arguments to the function are significant on process `root`, while on other processes, only arguments `sendbuf`, `sendcount`, `sendtype`, `root`, and `comm` are significant. The arguments `root` and `comm` must have identical values on all processes.

The specification of counts and types should not cause any location on the root to be written more than once. Such a call is erroneous.

Note that the `recvcount` argument at the root indicates the number of items it receives from *each* process, not the total number of items it receives.

The “in place” option for intracommunicators is specified by passing `MPI_IN_PLACE` as the value of `sendbuf` at the root. In such a case, `sendcount` and `sendtype` are ignored, and the contribution of the root to the gathered vector is assumed to be already in the correct place in the receive buffer.

If `comm` is an intercommunicator, then the call involves all processes in the intercommunicator, but with one group (group A) defining the root process. All processes in the other group (group B) pass the same value in argument `root`, which is the rank of the root in group A. The root passes the value `MPI_ROOT` in `root`. All other processes in group A pass the value `MPI_PROC_NULL` in `root`. Data is gathered from all processes in group B to the root. The send buffer arguments of the processes in group B must be consistent with the receive buffer argument of the root.

1	MPI_GATHERV(sendbuf, sendcount, sendtype, recvbuf, recvcnts, displs, recvtype, root,		
2	comm)		
3	IN	sendbuf	starting address of send buffer (choice)
4	IN	sendcount	number of elements in send buffer (non-negative integer)
5			
6			
7	IN	sendtype	data type of send buffer elements (handle)
8	OUT	recvbuf	address of receive buffer (choice, significant only at root)
9			
10			
11	IN	recvcnts	non-negative integer array (of length group size) containing the number of elements that are received from each process (significant only at root)
12			
13			
14	IN	displs	integer array (of length group size). Entry i specifies the displacement relative to recvbuf at which to place the incoming data from process i (significant only at root)
15			
16			
17			
18	IN	recvtype	data type of recv buffer elements (significant only at root) (handle)
19			
20			
21	IN	root	rank of receiving process (integer)
22	IN	comm	communicator (handle)

```

ticket140.24 int MPI_Gatherv(const void* sendbuf, int sendcount, MPI_Datatype sendtype,
ticket140.25 void* recvbuf, const int recvcnts[], const int displs[],
ticket140.26 MPI_Datatype recvtype, int root, MPI_Comm comm)

```

```

ticket229.1.27 MPI_Gatherv(sendbuf, sendcount, sendtype, recvbuf, recvcnts, displs,
ticket-248T.28 MPI_Gatherv(sendbuf, sendcount, sendtype, recvbuf, recvcnts, displs,
29 recvtype, root, comm, ierror) BIND(C)
30 TYPE(*), DIMENSION(..), INTENT(IN) :: sendbuf
31 TYPE(*), DIMENSION(..) :: recvbuf
32 INTEGER, INTENT(IN) :: sendcount, recvcnts(*), displs(*), root
33 TYPE(MPI_Datatype), INTENT(IN) :: sendtype, recvtype
34 TYPE(MPI_Comm), INTENT(IN) :: comm
35 INTEGER, OPTIONAL, INTENT(OUT) :: ierror

```

```

36 MPI_GATHERV(SENDBUF, SENDCOUNT, SENDTYPE, RECVBUF, RECVCOUNTS, DISPLS,
37 RECVTYPE, ROOT, COMM, IERROR)
38 <type> SENDBUF(*), RECVBUF(*)
39 INTEGER SENDCOUNT, SENDTYPE, RECVCOUNTS(*), DISPLS(*), RECVTYPE, ROOT,
40 COMM, IERROR

```

```

41 {void MPI::Comm::Gatherv(const void* sendbuf, int sendcount, const
42 MPI::Datatype& sendtype, void* recvbuf,
43 const int recvcnts[], const int displs[],
44 const MPI::Datatype& recvtype, int root) const = 0(binding
45 deprecated, see Section 15.2) }
46

```

47 MPI_GATHERV extends the functionality of MPI_GATHER by allowing a varying count
48 of data from each process, since recvcnts is now an array. It also allows more flexibility

as to where the data is placed on the root, by providing the new argument, `displs`. 1

If `comm` is an intracommunicator, the outcome is *as if* each process, including the root 2
process, sends a message to the root, 3

```
MPI_Send(sendbuf, sendcount, sendtype, root, ...), 4  
5
```

and the root executes `n` receives, 6

```
MPI_Recv(recvbuf + displs[j] * extent(recvtype), recvcnt[j], recvtype, i, ...). 7  
8  
9
```

The data received from process `j` is placed into `recvbuf` of the root process beginning at 10
offset `displs[j]` elements (in terms of the `recvtype`). 11

The receive buffer is ignored for all non-root processes. 12

The type signature implied by `sendcount`, `sendtype` on process `i` must be equal to the 13
type signature implied by `recvcnt[i]`, `recvtype` at the root. This implies that the amount 14
of data sent must be equal to the amount of data received, pairwise between each process 15
and the root. Distinct type maps between sender and receiver are still allowed, as illustrated 16
in Example 5.6. 17

All arguments to the function are significant on process `root`, while on other processes, 18
only arguments `sendbuf`, `sendcount`, `sendtype`, `root`, and `comm` are significant. The arguments 19
`root` and `comm` must have identical values on all processes. 20

The specification of counts, types, and displacements should not cause any location on 21
the root to be written more than once. Such a call is erroneous. 22

The “in place” option for intracommunicators is specified by passing `MPI_IN_PLACE` as 23
the value of `sendbuf` at the root. In such a case, `sendcount` and `sendtype` are ignored, and 24
the contribution of the root to the gathered vector is assumed to be already in the correct 25
place in the receive buffer `[]`. 26 ticket0.

If `comm` is an intercommunicator, then the call involves all processes in the intercom- 27
municator, but with one group (group A) defining the root process. All processes in the 28
other group (group B) pass the same value in argument `root`, which is the rank of the root 29
in group A. The root passes the value `MPI_ROOT` in `root`. All other processes in group A 30
pass the value `MPI_PROC_NULL` in `root`. Data is gathered from all processes in group B to 31
the root. The send buffer arguments of the processes in group B must be consistent with 32
the receive buffer argument of the root. 33

5.5.1 Examples using `MPI_GATHER`, `MPI_GATHERV` 34 35

The examples in this section use intracommunicators. 36
37

Example 5.2 38

Gather 100 ints from every process in group to root. See [\[f\]Figure 5.4](#). 39 ticket0.

```
MPI_Comm comm; 40  
int gsize, sendarray[100]; 41  
int root, *rbuf; 42  
... 43  
MPI_Comm_size(comm, &gsize); 44  
rbuf = (int *)malloc(gsize*100*sizeof(int)); 45  
MPI_Gather(sendarray, 100, MPI_INT, rbuf, 100, MPI_INT, root, comm); 46  
47  
48
```

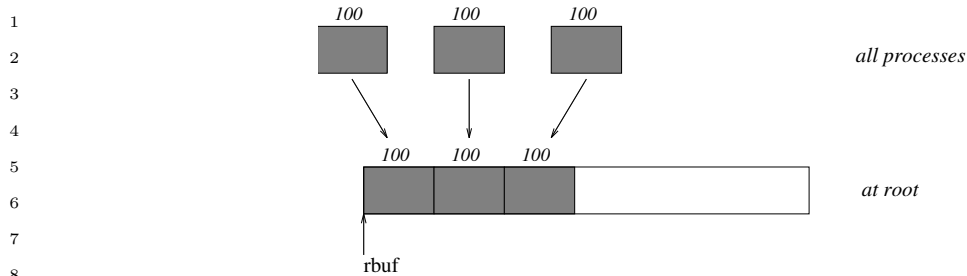

Figure 5.4: The root process gathers 100 ints from each process in the group.

Example 5.3

Previous example modified – only the root allocates memory for the receive buffer.

```

15 MPI_Comm comm;
16 int gsize, sendarray[100];
17 int root, myrank, *rbuf;
18 ...
19 MPI_Comm_rank(comm, &myrank);
20 if (myrank == root) {
21     MPI_Comm_size(comm, &gsize);
22     rbuf = (int *)malloc(gsize*100*sizeof(int));
23 }
24 MPI_Gather(sendarray, 100, MPI_INT, rbuf, 100, MPI_INT, root, comm);

```

Example 5.4

Do the same as the previous example, but use a derived datatype. Note that the type cannot be the entire set of `gsize*100` ints since type matching is defined pairwise between the root and each process in the gather.

```

31 MPI_Comm comm;
32 int gsize, sendarray[100];
33 int root, *rbuf;
34 MPI_Datatype rtype;
35 ...
36 MPI_Comm_size(comm, &gsize);
37 MPI_Type_contiguous(100, MPI_INT, &rtype);
38 MPI_Type_commit(&rtype);
39 rbuf = (int *)malloc(gsize*100*sizeof(int));
40 MPI_Gather(sendarray, 100, MPI_INT, rbuf, 1, rtype, root, comm);

```

Example 5.5

Now have each process send 100 ints to root, but place each set (of 100) `stride` ints apart at receiving end. Use `MPI_GATHERV` and the `displs` argument to achieve this effect. Assume `stride` ≥ 100 . See Figure 5.5.

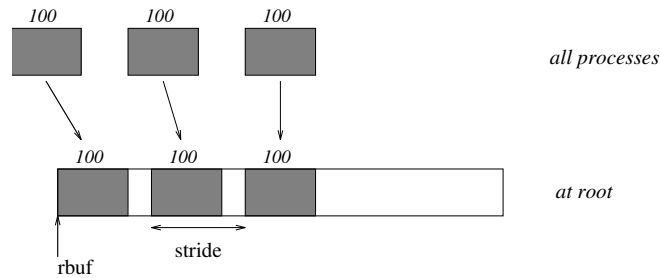

Figure 5.5: The root process gathers 100 ints from each process in the group, each set is placed *stride* ints apart.

```

MPI_Comm comm;
int gsize, sendarray[100];
int root, *rbuf, stride;
int *displs, i, *rcounts;

...

MPI_Comm_size(comm, &gsize);
rbuf = (int *)malloc(gsize*stride*sizeof(int));
displs = (int *)malloc(gsize*sizeof(int));
rcounts = (int *)malloc(gsize*sizeof(int));
for (i=0; i<gsize; ++i) {
    displs[i] = i*stride;
    rcounts[i] = 100;
}
MPI_Gatherv(sendarray, 100, MPI_INT, rbuf, rcounts, displs, MPI_INT,
            root, comm);

```

Note that the program is erroneous if *stride* < 100.

Example 5.6

Same as Example 5.5 on the receiving side, but send the 100 ints from the 0th column of a 100×150 int array, in C. See Figure 5.6.

```

MPI_Comm comm;
int gsize, sendarray[100][150];
int root, *rbuf, stride;
MPI_Datatype stype;
int *displs, i, *rcounts;

...

MPI_Comm_size(comm, &gsize);
rbuf = (int *)malloc(gsize*stride*sizeof(int));
displs = (int *)malloc(gsize*sizeof(int));
rcounts = (int *)malloc(gsize*sizeof(int));
for (i=0; i<gsize; ++i) {

```

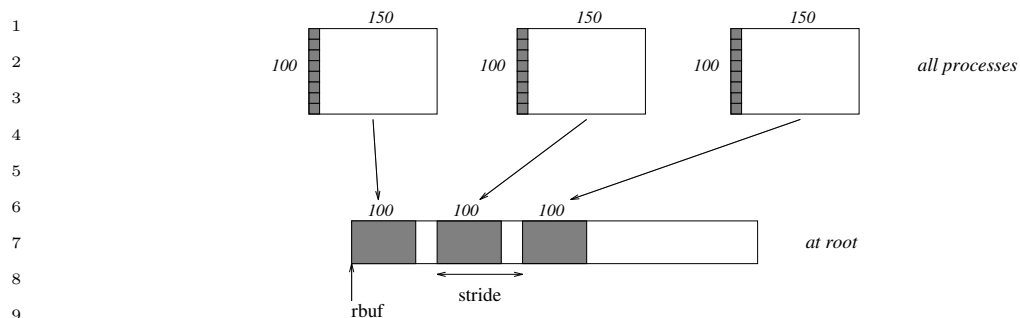

Figure 5.6: The root process gathers column 0 of a 100×150 C array, and each set is placed `stride` ints apart.

```

13
14     displs[i] = i*stride;
15     rcounts[i] = 100;
16 }
17 /* Create datatype for 1 column of array
18  */
19 MPI_Type_vector(100, 1, 150, MPI_INT, &stype);
20 MPI_Type_commit(&stype);
21 MPI_Gatherv(sendarray, 1, stype, rbuf, rcounts, displs, MPI_INT,
22             root, comm);
23

```

Example 5.7

Process i sends $(100-i)$ ints from the i -th column of a 100×150 int array, in C. It is received into a buffer with stride, as in the previous two examples. See Figure 5.7.

```

28 MPI_Comm comm;
29 int gsize, sendarray[100][150], *sptr;
30 int root, *rbuf, stride, myrank;
31 MPI_Datatype stype;
32 int *displs, i, *rcounts;
33
34 ...
35
36 MPI_Comm_size(comm, &gsize);
37 MPI_Comm_rank(comm, &myrank);
38 rbuf = (int *)malloc(gsize*stride*sizeof(int));
39 displs = (int *)malloc(gsize*sizeof(int));
40 rcounts = (int *)malloc(gsize*sizeof(int));
41 for (i=0; i<gsize; ++i) {
42     displs[i] = i*stride;
43     rcounts[i] = 100-i;    /* note change from previous example */
44 }
45 /* Create datatype for the column we are sending
46  */
47 MPI_Type_vector(100-myrank, 1, 150, MPI_INT, &stype);
48 MPI_Type_commit(&stype);

```

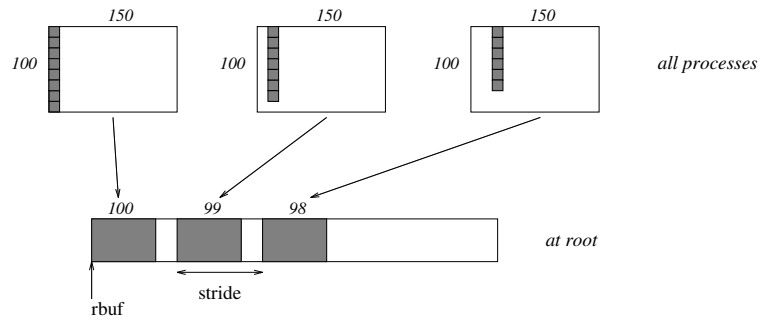

Figure 5.7: The root process gathers $100-i$ ints from column i of a 100×150 C array, and each set is placed `stride` ints apart.

```

/* sptr is the address of start of "myrank" column
 */
sptr = &sendarray[0][myrank];
MPI_Gatherv(sptr, 1, stype, rbuf, rcounts, displs, MPI_INT,
            root, comm);

```

Note that a different amount of data is received from each process.

Example 5.8

Same as Example 5.7, but done in a different way at the sending end. We create a datatype that causes the correct striding at the sending end so that we read a column of a C array. A similar thing was done in Example 4.16, Section 4.1.14.

```

MPI_Comm comm;
int gsize, sendarray[100][150], *sptr;
int root, *rbuf, stride, myrank, blocklen[2];
MPI_Aint disp[2];
MPI_Datatype stype, type[2];
int *displs, i, *rcounts;

...

MPI_Comm_size(comm, &gsize);
MPI_Comm_rank(comm, &myrank);
rbuf = (int *)malloc(gsize*stride*sizeof(int));
displs = (int *)malloc(gsize*sizeof(int));
rcounts = (int *)malloc(gsize*sizeof(int));
for (i=0; i<gsize; ++i) {
    displs[i] = i*stride;
    rcounts[i] = 100-i;
}
/* Create datatype for one int, with extent of entire row
 */
disp[0] = 0;      disp[1] = 150*sizeof(int);
type[0] = MPI_INT; type[1] = MPI_UB;
blocklen[0] = 1;  blocklen[1] = 1;

```

```

1 MPI_Type_create_struct(2, blocklen, disp, type, &stype);
2 MPI_Type_commit(&stype);
3 sptr = &sendarray[0][myrank];
4 MPI_Gatherv(sptr, 100-myrank, stype, rbuf, rcounts, displs, MPI_INT,
5                                                     root, comm);
6
7

```

Example 5.9

Same as Example 5.7 at sending side, but at receiving side we make the stride between received blocks vary from block to block. See Figure 5.8.

```

11 MPI_Comm comm;
12 int gsize, sendarray[100][150], *sptr;
13 int root, *rbuf, *stride, myrank, bufsize;
14 MPI_Datatype stype;
15 int *displs, i, *rcounts, offset;
16
17 ...
18
19 MPI_Comm_size(comm, &gsize);
20 MPI_Comm_rank(comm, &myrank);
21
22 stride = (int *)malloc(gsize*sizeof(int));
23
24 ...
25 /* stride[i] for i = 0 to gsize-1 is set somehow
26 */
27
28 /* set up displs and rcounts vectors first
29 */
30 displs = (int *)malloc(gsize*sizeof(int));
31 rcounts = (int *)malloc(gsize*sizeof(int));
32 offset = 0;
33 for (i=0; i<gsize; ++i) {
34     displs[i] = offset;
35     offset += stride[i];
36     rcounts[i] = 100-i;
37 }
38 /* the required buffer size for rbuf is now easily obtained
39 */
40 bufsize = displs[gsize-1]+rcounts[gsize-1];
41 rbuf = (int *)malloc(bufsize*sizeof(int));
42 /* Create datatype for the column we are sending
43 */
44 MPI_Type_vector(100-myrank, 1, 150, MPI_INT, &stype);
45 MPI_Type_commit(&stype);
46 sptr = &sendarray[0][myrank];
47 MPI_Gatherv(sptr, 1, stype, rbuf, rcounts, displs, MPI_INT,
48                                                     root, comm);

```

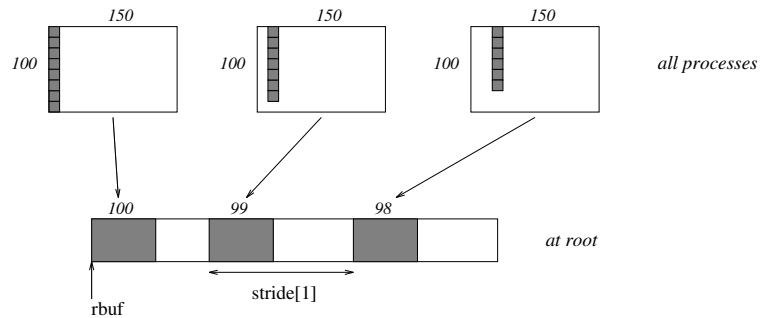



Figure 5.8: The root process gathers $100-i$ ints from column i of a 100×150 C array, and each set is placed $\text{stride}[i]$ ints apart (a varying stride).

Example 5.10

Process i sends num ints from the i -th column of a 100×150 int array, in C. The complicating factor is that the various values of num are not known to *root*, so a separate gather must first be run to find these out. The data is placed contiguously at the receiving end.

```

MPI_Comm comm;
int gsize, sendarray[100][150], *sptr;
int root, *rbuf, myrank, blocklen[2];
MPI_Aint disp[2];
MPI_Datatype stype, type[2];
int *displs, i, *rcounts, num;

...

MPI_Comm_size(comm, &gsize);
MPI_Comm_rank(comm, &myrank);

/* First, gather nums to root
 */
rcounts = (int *)malloc(gsize*sizeof(int));
MPI_Gather(&num, 1, MPI_INT, rcounts, 1, MPI_INT, root, comm);
/* root now has correct rcounts, using these we set displs[] so
 * that data is placed contiguously (or concatenated) at receive end
 */
displs = (int *)malloc(gsize*sizeof(int));
displs[0] = 0;
for (i=1; i<gsize; ++i) {
    displs[i] = displs[i-1]+rcounts[i-1];
}
/* And, create receive buffer
 */
rbuf = (int *)malloc(gsize*(displs[gsize-1]+rcounts[gsize-1])
                    *sizeof(int));
/* Create datatype for one int, with extent of entire row

```

```

1      */
2      disp[0] = 0;          disp[1] = 150*sizeof(int);
3      type[0] = MPI_INT; type[1] = MPI_UB;
4      blocklen[0] = 1;   blocklen[1] = 1;
5      MPI_Type_create_struct( 2, blocklen, disp, type, &stype );
6      MPI_Type_commit(&stype);
7      sptr = &sendarray[0][myrank];
8      MPI_Gatherv(sptr, num, stype, rbuf, rcounts, displs, MPI_INT,
9                                     root, comm);

```

5.6 Scatter

MPI_SCATTER(sendbuf, sendcount, sendtype, recvbuf, recvcount, recvtype, root, comm)

16	IN	sendbuf	address of send buffer (choice, significant only at root)
17			
18	IN	sendcount	number of elements sent to each process (non-negative integer, significant only at root)
19			
20	IN	sendtype	data type of send buffer elements (significant only at root) (handle)
21			
22	OUT	recvbuf	address of receive buffer (choice)
23			
24	IN	recvcount	number of elements in receive buffer (non-negative integer)
25			
26	IN	recvtype	data type of receive buffer elements (handle)
27	IN	root	rank of sending process (integer)
28	IN	comm	communicator (handle)
29			

```

ticket140. 30 int MPI_Scatter(const void* sendbuf, int sendcount, MPI_Datatype sendtype,
31               void* recvbuf, int recvcount, MPI_Datatype recvtype, int root,
32               MPI_Comm comm)

```

```

ticket229.1. 33
ticket-248T. 34 MPI_Scatter(sendbuf, sendcount, sendtype, recvbuf, recvcount, recvtype,
35            root, comm, ierror) BIND(C)
36            TYPE(*), DIMENSION(..), INTENT(IN) :: sendbuf
37            TYPE(*), DIMENSION(..) :: recvbuf
38            INTEGER, INTENT(IN) :: sendcount, recvcount, root
39            TYPE(MPI_Datatype), INTENT(IN) :: sendtype, recvtype
40            TYPE(MPI_Comm), INTENT(IN) :: comm
41            INTEGER, OPTIONAL, INTENT(OUT) :: ierror

```

```

42 MPI_SCATTER(SENDBUF, SENDCOUNT, SENDTYPE, RECVBUF, RECVCOUNT, RECVTYPE,
43            ROOT, COMM, IERROR)
44 <type> SENDBUF(*), RECVBUF(*)
45 INTEGER SENDCOUNT, SENDTYPE, RECVCOUNT, RECVTYPE, ROOT, COMM, IERROR

```

```

47 {void MPI::Comm::Scatter(const void* sendbuf, int sendcount, const
48 MPI::Datatype& sendtype, void* recvbuf, int recvcount,

```

```
const MPI::Datatype& recvtype, int root) const = 0(binding
deprecated, see Section 15.2) }
```

MPI_SCATTER is the inverse operation to MPI_GATHER.

If `comm` is an intracommunicator, the outcome is *as if* the root executed `n` send operations,

```
MPI_Send(sendbuf + i · sendcount · extent(sendtype), sendcount, sendtype, i, ...),
```

and each process executed a receive,

```
MPI_Recv(recvbuf, recvcount, recvtype, i, ...).
```

An alternative description is that the root sends a message with `MPI_Send(sendbuf, sendcount·n, sendtype, ...)`. This message is split into `n` equal segments, the i -th segment is sent to the i -th process in the group, and each process receives this message as above.

The send buffer is ignored for all non-root processes.

The type signature associated with `sendcount`, `sendtype` at the root must be equal to the type signature associated with `recvcount`, `recvtype` at all processes (however, the type maps may be different). This implies that the amount of data sent must be equal to the amount of data received, pairwise between each process and the root. Distinct type maps between sender and receiver are still allowed.

All arguments to the function are significant on process `root`, while on other processes, only arguments `recvbuf`, `recvcount`, `recvtype`, `root`, and `comm` are significant. The arguments `root` and `comm` must have identical values on all processes.

The specification of counts and types should not cause any location on the root to be read more than once.

Rationale. Though not needed, the last restriction is imposed so as to achieve symmetry with MPI_GATHER, where the corresponding restriction (a multiple-write restriction) is necessary. (*End of rationale.*)

The “in place” option for intracommunicators is specified by passing `MPI_IN_PLACE` as the value of `recvbuf` at the root. In such a case, `recvcount` and `recvtype` are ignored, and root “sends” no data to itself. The scattered vector is still assumed to contain n segments, where n is the group size; the $root$ -th segment, which root should “send to itself,” is not moved.

If `comm` is an intercommunicator, then the call involves all processes in the intercommunicator, but with one group (group A) defining the root process. All processes in the other group (group B) pass the same value in argument `root`, which is the rank of the root in group A. The root passes the value `MPI_ROOT` in `root`. All other processes in group A pass the value `MPI_PROC_NULL` in `root`. Data is scattered from the root to all processes in group B. The receive buffer arguments of the processes in group B must be consistent with the send buffer argument of the root.

1	MPI_SCATTERV(sendbuf, sendcounts, displs, sendtype, recvbuf, recvcount, recvtpe, root,		
2	comm)		
3	IN	sendbuf	address of send buffer (choice, significant only at root)
4	IN	sendcounts	non-negative integer array (of length group size) speci-
5			fying the number of elements to send to each [processor]rank ticket0.
6			
7	IN	displs	integer array (of length group size). Entry i specifies
8			the displacement (relative to sendbuf) from which to
9			take the outgoing data to process i
10	IN	sendtype	data type of send buffer elements (handle)
11	OUT	recvbuf	address of receive buffer (choice)
12	IN	recvcount	number of elements in receive buffer (non-negative in-
13			teger)
14			
15	IN	recvtpe	data type of receive buffer elements (handle)
16			
17	IN	root	rank of sending process (integer)
18	IN	comm	communicator (handle)
19			

```

ticket140. 20 int MPI_Scatterv(const void* sendbuf, const int sendcounts[], const
ticket140. 21             int displs[], MPI_Datatype sendtype, void* recvbuf,
ticket140. 22             int recvcount, MPI_Datatype recvtpe, int root, MPI_Comm comm)
ticket229.1. 23
ticket-248T. 24

```

```

25 MPI_Scatterv(sendbuf, sendcounts, displs, sendtype, recvbuf, recvcount,
26             recvtpe, root, comm, ierror) BIND(C)
27 TYPE(*), DIMENSION(..), INTENT(IN) :: sendbuf
28 TYPE(*), DIMENSION(..) :: recvbuf
29 INTEGER, INTENT(IN) :: sendcounts(*), displs(*), recvcount, root
30 TYPE(MPI_Datatype), INTENT(IN) :: sendtype, recvtpe
31 TYPE(MPI_Comm), INTENT(IN) :: comm
32 INTEGER, OPTIONAL, INTENT(OUT) :: ierror
33
34 MPI_SCATTERV(SENDBUF, SENDCOUNTS, DISPLS, SENDTYPE, RECVBUF, REVCOUNT,
35             RECVTYPE, ROOT, COMM, IERROR)
36 <type> SENDBUF(*), RECVBUF(*)
37 INTEGER SENDCOUNTS(*), DISPLS(*), SENDTYPE, REVCOUNT, RECVTYPE, ROOT,
38 COMM, IERROR

```

```

39 {void MPI::Comm::Scatterv(const void* sendbuf, const int sendcounts[],
40                          const int displs[], const MPI::Datatype& sendtype,
41                          void* recvbuf, int recvcount, const MPI::Datatype& recvtpe,
42                          int root) const = 0(binding deprecated, see Section 15.2) }

```

MPI_SCATTERV is the inverse operation to MPI_GATHERV.

MPI_SCATTERV extends the functionality of MPI_SCATTER by allowing a varying count of data to be sent to each process, since sendcounts is now an array. It also allows more flexibility as to where the data is taken from on the root, by providing an additional argument, displs.

If `comm` is an intracommunicator, the outcome is as if the root executed `n` send operations,

```
MPI_Send(sendbuf + displs[i] * extent(sendtype), sendcounts[i], sendtype, i, ...),
```

and each process executed a receive,

```
MPI_Recv(recvbuf, recvcount, recvtype, i, ...).
```

The send buffer is ignored for all non-root processes.

The type signature implied by `sendcount[i]`, `sendtype` at the root must be equal to the type signature implied by `recvcount`, `recvtype` at process `i` (however, the type maps may be different). This implies that the amount of data sent must be equal to the amount of data received, pairwise between each process and the root. Distinct type maps between sender and receiver are still allowed.

All arguments to the function are significant on process `root`, while on other processes, only arguments `recvbuf`, `recvcount`, `recvtype`, `root`, and `comm` are significant. The arguments `root` and `comm` must have identical values on all processes.

The specification of counts, types, and displacements should not cause any location on the root to be read more than once.

The “in place” option for intracommunicators is specified by passing `MPI_IN_PLACE` as the value of `recvbuf` at the root. In such a case, `recvcount` and `recvtype` are ignored, and root “sends” no data to itself. The scattered vector is still assumed to contain n segments, where n is the group size; the $root$ -th segment, which root should “send to itself,” is not moved.

If `comm` is an intercommunicator, then the call involves all processes in the intercommunicator, but with one group (group A) defining the root process. All processes in the other group (group B) pass the same value in argument `root`, which is the rank of the root in group A. The root passes the value `MPI_ROOT` in `root`. All other processes in group A pass the value `MPI_PROC_NULL` in `root`. Data is scattered from the root to all processes in group B. The receive buffer arguments of the processes in group B must be consistent with the send buffer argument of the root.

5.6.1 Examples using `MPI_SCATTER`, `MPI_SCATTERV`

The examples in this section use intracommunicators.

Example 5.11

The reverse of Example 5.2. Scatter sets of 100 ints from the root to each process in the group. See Figure 5.9.

```
MPI_Comm comm;
int gsize,*sendbuf;
int root, rbuf[100];
...
MPI_Comm_size(comm, &gsize);
sendbuf = (int *)malloc(gsize*100*sizeof(int));
...
MPI_Scatter(sendbuf, 100, MPI_INT, rbuf, 100, MPI_INT, root, comm);
```

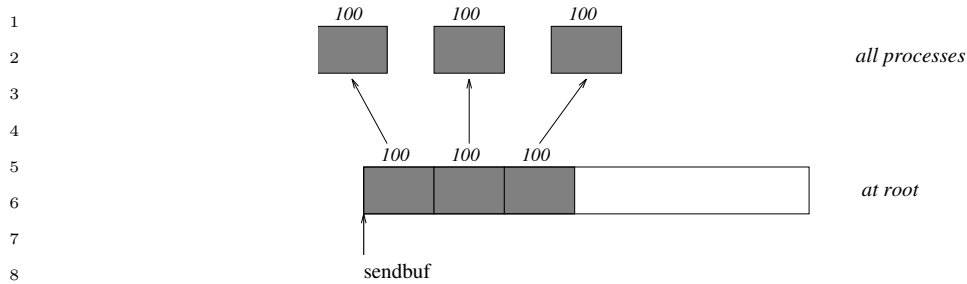

Figure 5.9: The root process scatters sets of 100 ints to each process in the group.

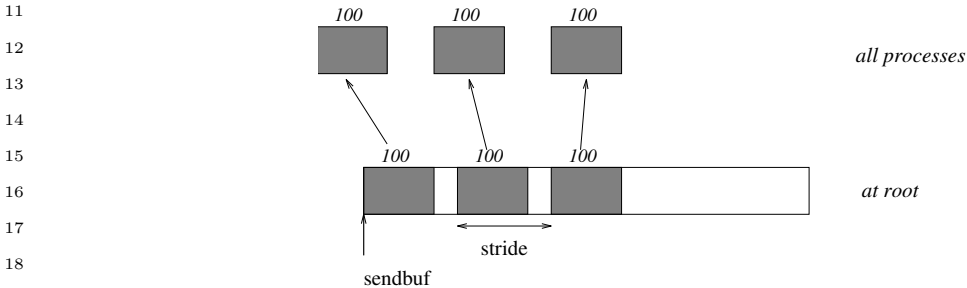

Figure 5.10: The root process scatters sets of 100 ints, moving by `stride` ints from send to send in the scatter.

Example 5.12

The reverse of Example 5.5. The root process scatters sets of 100 ints to the other processes, but the sets of 100 are *stride* ints apart in the sending buffer. Requires use of `MPI_SCATTERV`. Assume *stride* \geq 100. See Figure 5.10.

```

28 MPI_Comm comm;
29 int gsize,*sendbuf;
30 int root, rbuf[100], i, *displs, *scounts;
31
32 ...
33
34 MPI_Comm_size(comm, &gsize);
35 sendbuf = (int *)malloc(gsize*stride*sizeof(int));
36 ...
37 displs = (int *)malloc(gsize*sizeof(int));
38 scounts = (int *)malloc(gsize*sizeof(int));
39 for (i=0; i<gsize; ++i) {
40     displs[i] = i*stride;
41     scounts[i] = 100;
42 }
43 MPI_Scatterv(sendbuf, scounts, displs, MPI_INT, rbuf, 100, MPI_INT,
44             root, comm);
45
46
47
48

```

Example 5.13

The reverse of Example 5.9. We have a varying stride between blocks at sending (root) side, at the receiving side we receive into the i -th column of a 100×150 C array. See Figure 5.11.

```

MPI_Comm comm;
int gsize, recvarray[100][150], *rptr;
int root, *sendbuf, myrank, *stride;
MPI_Datatype rtype;
int i, *displs, *counts, offset;
...
MPI_Comm_size(comm, &gsize);
MPI_Comm_rank(comm, &myrank);

stride = (int *)malloc(gsize*sizeof(int));
...
/* stride[i] for i = 0 to gsize-1 is set somehow
 * sendbuf comes from elsewhere
 */
...
displs = (int *)malloc(gsize*sizeof(int));
counts = (int *)malloc(gsize*sizeof(int));
offset = 0;
for (i=0; i<gsize; ++i) {
    displs[i] = offset;
    offset += stride[i];
    counts[i] = 100 - i;
}
/* Create datatype for the column we are receiving
 */
MPI_Type_vector(100-myrank, 1, 150, MPI_INT, &rtype);
MPI_Type_commit(&rtype);
rptr = &recvarray[0][myrank];
MPI_Scatterv(sendbuf, counts, displs, MPI_INT, rptr, 1, rtype,
            root, comm);

```

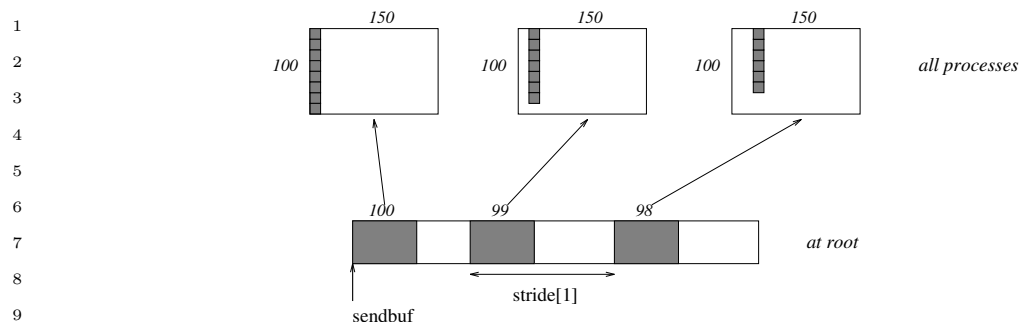

Figure 5.11: The root scatters blocks of $100-i$ ints into column i of a 100×150 C array. At the sending side, the blocks are `stride[i]` ints apart.

5.7 Gather-to-all

`MPI_ALLGATHER(sendbuf, sendcount, sendtype, recvbuf, recvcount, recvtype, comm)`

IN	<code>sendbuf</code>	starting address of send buffer (choice)
IN	<code>sendcount</code>	number of elements in send buffer (non-negative integer)
IN	<code>sendtype</code>	data type of send buffer elements (handle)
OUT	<code>recvbuf</code>	address of receive buffer (choice)
IN	<code>recvcount</code>	number of elements received from any process (non-negative integer)
IN	<code>recvtype</code>	data type of receive buffer elements (handle)
IN	<code>comm</code>	communicator (handle)

```

ticket140. 31 int MPI_Allgather(const void* sendbuf, int sendcount,
32               MPI_Datatype sendtype, void* recvbuf, int recvcount,
33               MPI_Datatype recvtype, MPI_Comm comm)
ticket229.1. 34 MPI_Allgather(sendbuf, sendcount, sendtype, recvbuf, recvcount, recvtype,
ticket-248T. 35               comm, ierror) BIND(C)
36               TYPE(*), DIMENSION(..), INTENT(IN) :: sendbuf
37               TYPE(*), DIMENSION(..) :: recvbuf
38               INTEGER, INTENT(IN) :: sendcount, recvcount
39               TYPE(MPI_Datatype), INTENT(IN) :: sendtype, recvtype
40               TYPE(MPI_Comm), INTENT(IN) :: comm
41               INTEGER, OPTIONAL, INTENT(OUT) :: ierror
42
43 MPI_ALLGATHER(SENDBUF, SENDCOUNT, SENDTYPE, RECVBUF, REVCOUNT, RECVTYPE,
44               COMM, IERROR)
45 <type> SENDBUF(*), RECVBUF(*)
46 INTEGER SENDCOUNT, SENDTYPE, REVCOUNT, RECVTYPE, COMM, IERROR
47
48

```



```
{void MPI::Comm::Allgather(const void* sendbuf, int sendcount, const
    MPI::Datatype& sendtype, void* recvbuf, int recvcount,
    const MPI::Datatype& recvtype) const = 0(binding deprecated, see
    Section 15.2) }
```

MPI_ALLGATHER can be thought of as MPI_GATHER, but where all processes receive the result, instead of just the root. The block of data sent from the j -th process is received by every process and placed in the j -th block of the buffer `recvbuf`.

The type signature associated with `sendcount`, `sendtype`, at a process must be equal to the type signature associated with `recvcount`, `recvtype` at any other process.

If `comm` is an intracommunicator, the outcome of a call to `MPI_ALLGATHER(...)` is as if all processes executed `n` calls to

```
MPI_Gather(sendbuf, sendcount, sendtype, recvbuf, recvcount,
           recvtype, root, comm)
```

for `root = 0, ..., n-1`. The rules for correct usage of `MPI_ALLGATHER` are easily found from the corresponding rules for `MPI_GATHER`.

The “in place” option for intracommunicators is specified by passing the value `MPI_IN_PLACE` to the argument `sendbuf` at all processes. `sendcount` and `sendtype` are ignored. Then the input data of each process is assumed to be in the area where that process would receive its own contribution to the receive buffer.

If `comm` is an intercommunicator, then each process of one group (group A) contributes `sendcount` data items; these data are concatenated and the result is stored at each process in the other group (group B). Conversely the concatenation of the contributions of the processes in group B is stored at each process in group A. The send buffer arguments in group A must be consistent with the receive buffer arguments in group B, and vice versa.

Advice to users. The communication pattern of `MPI_ALLGATHER` executed on an intercommunication domain need not be symmetric. The number of items sent by processes in group A (as specified by the arguments `sendcount`, `sendtype` in group A and the arguments `recvcount`, `recvtype` in group B), need not equal the number of items sent by processes in group B (as specified by the arguments `sendcount`, `sendtype` in group B and the arguments `recvcount`, `recvtype` in group A). In particular, one can move data in only one direction by specifying `sendcount = 0` for the communication in the reverse direction.

(End of advice to users.)

1 MPI_ALLGATHERV(sendbuf, sendcount, sendtype, recvbuf, recvcnts, displs, recvtype, comm)

2			
3	IN	sendbuf	starting address of send buffer (choice)
4			
5	IN	sendcount	number of elements in send buffer (non-negative integer)
6			
7	IN	sendtype	data type of send buffer elements (handle)
8	OUT	recvbuf	address of receive buffer (choice)
9			
10	IN	recvcnts	non-negative integer array (of length group size) containing the number of elements that are received from each process
11			
12			
13	IN	displs	integer array (of length group size). Entry <i>i</i> specifies the displacement (relative to <code>recvbuf</code>) at which to place the incoming data from process <i>i</i>
14			
15			
16	IN	recvtype	data type of receive buffer elements (handle)
17			
18	IN	comm	communicator (handle)
19			

ticket140. 20 int MPI_Allgatherv(const void* sendbuf, int sendcount,
 ticket140. 21 MPI_Datatype sendtype, void* recvbuf, const int recvcnts[],
 ticket140. 22 const int displs[], MPI_Datatype recvtype, MPI_Comm comm)

ticket229.1. 23 MPI_Allgatherv(sendbuf, sendcount, sendtype, recvbuf, recvcnts, displs,
 ticket-248T. 24 recvtype, comm, ierror) BIND(C)
 25 TYPE(*), DIMENSION(..), INTENT(IN) :: sendbuf
 26 TYPE(*), DIMENSION(..) :: recvbuf
 27 INTEGER, INTENT(IN) :: sendcount, recvcnts(*), displs(*)
 28 TYPE(MPI_Datatype), INTENT(IN) :: sendtype, recvtype
 29 TYPE(MPI_Comm), INTENT(IN) :: comm
 30 INTEGER, OPTIONAL, INTENT(OUT) :: ierror

32 MPI_ALLGATHERV(SENDBUF, SENDCOUNT, SENDTYPE, RECVBUF, RECVCOUNTS, DISPLS,
 33 RECVTYPE, COMM, IERROR)
 34 <type> SENDBUF(*), RECVBUF(*)
 35 INTEGER SENDCOUNT, SENDTYPE, RECVCOUNTS(*), DISPLS(*), RECVTYPE, COMM,
 36 IERROR

37 {void MPI::Comm::Allgatherv(const void* sendbuf, int sendcount, const
 38 MPI::Datatype& sendtype, void* recvbuf,
 39 const int recvcnts[], const int displs[],
 40 const MPI::Datatype& recvtype) const = 0(*binding deprecated, see*
 41 *Section 15.2*) }

43 MPI_ALLGATHERV can be thought of as MPI_GATHERV, but where all processes receive the result, instead of just the root. The block of data sent from the *j*-th process is received by every process and placed in the *j*-th block of the buffer `recvbuf`. These blocks need not all be the same size.

47 The type signature associated with `sendcount`, `sendtype`, at process *j* must be equal to
 48 the type signature associated with `recvcnts[j]`, `recvtype` at any other process.

If `comm` is an intracommunicator, the outcome is as if all processes executed calls to

```
MPI_GATHERV(sendbuf, sendcount, sendtype, recvbuf, recvcnts, displs,
            recvtype, root, comm),
```

for `root = 0, ..., n-1`. The rules for correct usage of `MPI_ALLGATHERV` are easily found from the corresponding rules for `MPI_GATHERV`.

The “in place” option for intracommunicators is specified by passing the value `MPI_IN_PLACE` to the argument `sendbuf` at all processes. In such a case, `sendcount` and `sendtype` are ignored, and the input data of each process is assumed to be in the area where that process would receive its own contribution to the receive buffer.

If `comm` is an intercommunicator, then each process of one group (group A) contributes `sendcount` data items; these data are concatenated and the result is stored at each process in the other group (group B). Conversely the concatenation of the contributions of the processes in group B is stored at each process in group A. The send buffer arguments in group A must be consistent with the receive buffer arguments in group B, and vice versa.

5.7.1 Example using `MPI_ALLGATHER`

The example in this section uses intracommunicators.

Example 5.14

The all-gather version of Example 5.2. Using `MPI_ALLGATHER`, we will gather 100 `ints` from every process in the group to every process.

```
MPI_Comm comm;
int gsize, sendarray[100];
int *rbuf;
...
MPI_Comm_size(comm, &gsize);
rbuf = (int *)malloc(gsize*100*sizeof(int));
MPI_Allgather(sendarray, 100, MPI_INT, rbuf, 100, MPI_INT, comm);
```

After the call, every process has the group-wide concatenation of the sets of data.

5.8 All-to-All Scatter/Gather

```

1 MPI_ALLTOALL(sendbuf, sendcount, sendtype, recvbuf, recvcoun, recvtype, comm)
2
3
4
5 MPI_ALLTOALL(sendbuf, sendcount, sendtype, recvbuf, recvcoun, recvtype, comm)
6     IN      sendbuf      starting address of send buffer (choice)
7     IN      sendcount    number of elements sent to each process (non-negative
8                          integer)
9     IN      sendtype     data type of send buffer elements (handle)
10    OUT     recvbuf      address of receive buffer (choice)
11    IN      recvcoun     number of elements received from any process (non-
12                          negative integer)
13
14    IN      recvtype     data type of receive buffer elements (handle)
15
16    IN      comm         communicator (handle)

```

```

ticket140. 17 int MPI_Alltoall(const void* sendbuf, int sendcount, MPI_Datatype sendtype,
18              void* recvbuf, int recvcoun, MPI_Datatype recvtype,
19              MPI_Comm comm)

```

```

ticket229.1. 20 MPI_Alltoall(sendbuf, sendcount, sendtype, recvbuf, recvcoun, recvtype,
ticket-248T. 21 MPI_Alltoall(sendbuf, sendcount, sendtype, recvbuf, recvcoun, recvtype,
22              comm, ierror) BIND(C)
23      TYPE(*), DIMENSION(..), INTENT(IN) :: sendbuf
24      TYPE(*), DIMENSION(..) :: recvbuf
25      INTEGER, INTENT(IN) :: sendcount, recvcoun
26      TYPE(MPI_Datatype), INTENT(IN) :: sendtype, recvtype
27      TYPE(MPI_Comm), INTENT(IN) :: comm
28      INTEGER, OPTIONAL, INTENT(OUT) :: ierror

```

```

29 MPI_ALLTOALL(SENDBUF, SENDCOUNT, SENDTYPE, RECVBUF, RECVCOUNT, RECVTYPE,
30              COMM, IERROR)
31 <type> SENDBUF(*), RECVBUF(*)
32 INTEGER SENDCOUNT, SENDTYPE, RECVCOUNT, RECVTYPE, COMM, IERROR

```

```

34 {void MPI::Comm::Alltoall(const void* sendbuf, int sendcount, const
35      MPI::Datatype& sendtype, void* recvbuf, int recvcoun,
36      const MPI::Datatype& recvtype) const = 0(binding deprecated, see
37      Section 15.2) }

```

MPI_ALLTOALL is an extension of MPI_ALLGATHER to the case where each process sends distinct data to each of the receivers. The j -th block sent from process i is received by process j and is placed in the i -th block of `recvbuf`.

The type signature associated with `sendcount`, `sendtype`, at a process must be equal to the type signature associated with `recvcoun`, `recvtype` at any other process. This implies that the amount of data sent must be equal to the amount of data received, pairwise between every pair of processes. As usual, however, the type maps may be different.

If `comm` is an intracommunicator, the outcome is as if each process executed a send to each process (itself included) with a call to,

```

48 MPI_Send(sendbuf + i · sendcount · extent(sendtype), sendcount, sendtype, i, ...),

```

and a receive from every other process with a call to,

```
MPI_Recv(recvbuf + i · recvcount · extent(recvtype), recvcount, recvtype, i, ...).
```

All arguments on all processes are significant. The argument `comm` must have identical values on all processes.

The “in place” option for intracommunicators is specified by passing `MPI_IN_PLACE` to the argument `sendbuf` at *all* processes. In such a case, `sendcount` and `sendtype` are ignored. The data to be sent is taken from the `recvbuf` and replaced by the received data. Data sent and received must have the same type map as specified by `recvcount` and `recvtype`.

Rationale. For large `MPI_ALLTOALL` instances, allocating both send and receive buffers may consume too much memory. The “in place” option effectively halves the application memory consumption and is useful in situations where the data to be sent will not be used by the sending process after the `MPI_ALLTOALL` exchange (e.g., in parallel Fast Fourier Transforms). (*End of rationale.*)

Advice to implementors. Users may opt to use the “in place” option in order to conserve memory. Quality MPI implementations should thus strive to minimize system buffering. (*End of advice to implementors.*)

If `comm` is an intercommunicator, then the outcome is as if each process in group A sends a message to each process in group B, and vice versa. The *j*-th send buffer of process *i* in group A should be consistent with the *i*-th receive buffer of process *j* in group B, and vice versa.

Advice to users. When a complete exchange is executed on an intercommunication domain, then the number of data items sent from processes in group A to processes in group B need not equal the number of items sent in the reverse direction. In particular, one can have unidirectional communication by specifying `sendcount = 0` in the reverse direction.

(*End of advice to users.*)

1	MPI_ALLTOALLV(sendbuf, sendcounts, sdispls, sendtype, recvbuf, recvcoun-		
2	ts, rdispls, recvtype, comm)		
3	IN	sendbuf	starting address of send buffer (choice)
4	IN	sendcounts	non-negative integer array (of length group size) speci-
5			fying the number of elements to send to each [processor]rank ticket0.
6			
7	IN	sdispls	integer array (of length group size). Entry j specifies
8			the displacement (relative to sendbuf) from which to ticket109.
9			take the outgoing data destined for process j
10	IN	sendtype	data type of send buffer elements (handle)
11	OUT	recvbuf	address of receive buffer (choice)
12	IN	recvcoun-	non-negative integer array (of length group size) speci-
13		ts	fying the number of elements that can be received
14			from each [processor]rank ticket0.
15			
16	IN	rdispls	integer array (of length group size). Entry i specifies
17			the displacement (relative to recvbuf) at which to place ticket109.
18			the incoming data from process i
19			
20	IN	recvtype	data type of receive buffer elements (handle)
21	IN	comm	communicator (handle)
22			

```

ticket140. 23 int MPI_Alltoallv(const void* sendbuf, const int sendcounts[], const
ticket140. 24 int sdispls[], MPI_Datatype sendtype, void* recvbuf, const
ticket140. 25 int recvcoun-
```

```

ticket140. 26 ts, rdispls, MPI_Datatype recvtype,
ticket140. 27 MPI_Comm comm)
```

```

ticket229.1. 28 MPI_Alltoallv(sendbuf, sendcounts, sdispls, sendtype, recvbuf, recvcoun-
```

```

ticket-248T. 29 rdispls, recvtype, comm, ierror) BIND(C)
```

```

30 TYPE(*), DIMENSION(..), INTENT(IN) :: sendbuf
```

```

31 TYPE(*), DIMENSION(..) :: recvbuf
```

```

32 INTEGER, INTENT(IN) :: sendcounts(*), sdispls(*), recvcoun-(*),
```

```

33 rdispls(*)
```

```

34 TYPE(MPI_Datatype), INTENT(IN) :: sendtype, recvtype
```

```

35 TYPE(MPI_Comm), INTENT(IN) :: comm
```

```

36 INTEGER, OPTIONAL, INTENT(OUT) :: ierror
```

```

37 MPI_ALLTOALLV(SENDBUF, SENDCOUNTS, SDISPLS, SENDTYPE, RECVBUF, REVCOUNTS,
38 RDISPLS, RECVTYPE, COMM, IERROR)
```

```

39 <type> SENDBUF(*), RECVBUF(*)
```

```

40 INTEGER SENDCOUNTS(*), SDISPLS(*), SENDTYPE, REVCOUNTS(*), RDISPLS(*),
```

```

41 RECVTYPE, COMM, IERROR
```

```

42
43 {void MPI::Comm::Alltoallv(const void* sendbuf, const int sendcounts[],
44 const int sdispls[], const MPI::Datatype& sendtype,
45 void* recvbuf, const int recvcoun-
```

```

46 ts, const MPI::Datatype& recvtype) const = 0(binding deprecated, see
```

```

47 Section 15.2) }
```

48

MPI_ALLTOALLV adds flexibility to MPI_ALLTOALL in that the location of data for the send is specified by `sdispls` and the location of the placement of the data on the receive side is specified by `rdispls`.

If `comm` is an intracommunicator, then the j -th block sent from process i is received by process j and is placed in the i -th block of `recvbuf`. These blocks need not all have the same size.

The type signature associated with `sendcounts[j]`, `sendtype` at process i must be equal to the type signature associated with `recvcounts[i]`, `recvtype` at process j . This implies that the amount of data sent must be equal to the amount of data received, pairwise between every pair of processes. Distinct type maps between sender and receiver are still allowed.

The outcome is as if each process sent a message to every other process with,

```
MPI_Send(sendbuf + sdispls[i] · extent(sendtype), sendcounts[i], sendtype, i, ...),
```

and received a message from every other process with a call to

```
MPI_Recv(recvbuf + rdispls[i] · extent(recvtype), recvcounts[i], recvtype, i, ...).
```

All arguments on all processes are significant. The argument `comm` must have identical values on all processes.

The “in place” option for intracommunicators is specified by passing `MPI_IN_PLACE` to the argument `sendbuf` at *all* processes. In such a case, `sendcounts`, `sdispls` and `sendtype` are ignored. The data to be sent is taken from the `recvbuf` and replaced by the received data. Data sent and received must have the same type map as specified by the `recvcounts` array and the `recvtype`, and is taken from the locations of the receive buffer specified by `rdispls`.

Advice to users. Specifying the “in place” option (which must be given on all processes) implies that the same amount and type of data is sent and received between any two processes in the group of the communicator. Different pairs of processes can exchange different amounts of data. Users must ensure that `recvcounts[j]` and `recvtype` on process i match `recvcounts[i]` and `recvtype` on process j . This symmetric exchange can be useful in applications where the data to be sent will not be used by the sending process after the MPI_ALLTOALLV exchange. (*End of advice to users.*)

If `comm` is an intercommunicator, then the outcome is as if each process in group A sends a message to each process in group B, and vice versa. The j -th send buffer of process i in group A should be consistent with the i -th receive buffer of process j in group B, and vice versa.

Rationale. The definitions of MPI_ALLTOALL and MPI_ALLTOALLV give as much flexibility as one would achieve by specifying n independent, point-to-point communications, with two exceptions: all messages use the same datatype, and messages are scattered from (or gathered to) sequential storage. (*End of rationale.*)

Advice to implementors. Although the discussion of collective communication in terms of point-to-point operation implies that each message is transferred directly from sender to receiver, implementations may use a tree communication pattern. Messages can be forwarded by intermediate nodes where they are split (for scatter) or concatenated (for gather), if this is more efficient. (*End of advice to implementors.*)

	1	MPI_ALLTOALLW(sendbuf, sendcounts, sdispls, sendtypes, recvbuf, recvcounts, rdispls,	
	2	recvtypes, comm)	
	3	IN	sendbuf starting address of send buffer (choice)
ticket0.	4	IN	sendcounts non-negative integer array (of length group size) speci-
	5		fying the number of elements to send to each [processor]rank
	6	IN	sdispls integer array (of length group size). Entry j specifies
	7		the displacement in bytes (relative to sendbuf) from
	8		which to take the outgoing data destined for process
	9		j (array of integers)
	10	IN	sendtypes array of datatypes (of length group size). Entry j
	11		specifies the type of data to send to process j (array
	12		of handles)
	13	OUT	recvbuf address of receive buffer (choice)
	14	IN	recvcounts non-negative integer array (of length group size) spec-
ticket0.	15		ifying the number of elements that can be received
	16		from each [processor]rank
	17	IN	rdispls integer array (of length group size). Entry i specifies
	18		the displacement in bytes (relative to recvbuf) at which
	19		to place the incoming data from process i (array of
	20		integers)
	21	IN	recvtypes array of datatypes (of length group size). Entry i
	22		specifies the type of data received from process i (ar-
	23		ray of handles)
	24	IN	comm communicator (handle)
	25		
	26		
ticket140.	27	int MPI_Alltoallw(const void* sendbuf, const int sendcounts[], const	
ticket140.	28	int sdispls[], const MPI_Datatype sendtypes[], void* recvbuf,	
ticket140.	29	const int recvcounts[], const int rdispls[], const	
ticket140.	30	MPI_Datatype recvtypes[], MPI_Comm comm)	
ticket140.	31	MPI_Alltoallw(sendbuf, sendcounts, sdispls, sendtypes, recvbuf, recvcounts,	
ticket140.	32	rdispls, recvtypes, comm, ierror) BIND(C)	
ticket140.	33	TYPE(*), DIMENSION(..), INTENT(IN) :: sendbuf	
ticket140.	34	TYPE(*), DIMENSION(..) :: recvbuf	
ticket140.	35	INTEGER, INTENT(IN) :: sendcounts(*), sdispls(*), recvcounts(*),	
ticket-248T.	36	rdispls(*)	
	37	TYPE(MPI_Datatype), INTENT(IN) :: sendtypes(*)	
	38	TYPE(MPI_Datatype), INTENT(IN) :: recvtypes(*)	
	39	TYPE(MPI_Comm), INTENT(IN) :: comm	
	40	INTEGER, OPTIONAL, INTENT(OUT) :: ierror	
	41	MPI_ALLTOALLW(SENDBUF, SENDCOUNTS, SDISPLS, SENDTYPES, RECVBUF, RECVCOUNTS,	
	42	RDISPLS, RECVTYPES, COMM, IERROR)	
	43	<type> SENDBUF(*), RECVBUF(*)	
	44	INTEGER SENDCOUNTS(*), SDISPLS(*), SENDTYPES(*), RECVCOUNTS(*),	
	45	RDISPLS(*), RECVTYPES(*), COMM, IERROR	

```

{void MPI::Comm::Alltoallw(const void* sendbuf, const int sendcounts[],
    const int sdispls[], const MPI::Datatype sendtypes[], void*
    recvbuf, const int recvcounst[], const int rdispls[], const
    MPI::Datatype recvtypes[]) const = 0(binding deprecated, see
    Section 15.2) }

```

MPI_ALLTOALLW is the most general form of complete exchange. Like MPI_TYPE_CREATE_STRUCT, the most general type constructor, MPI_ALLTOALLW allows separate specification of count, displacement and datatype. In addition, to allow maximum flexibility, the displacement of blocks within the send and receive buffers is specified in bytes.

If `comm` is an intracommunicator, then the j -th block sent from process i is received by process j and is placed in the i -th block of `recvbuf`. These blocks need not all have the same size.

The type signature associated with `sendcounts[j]`, `sendtypes[j]` at process i must be equal to the type signature associated with `recvcounst[i]`, `recvtypes[i]` at process j . This implies that the amount of data sent must be equal to the amount of data received, pairwise between every pair of processes. Distinct type maps between sender and receiver are still allowed.

The outcome is as if each process sent a message to every other process with

```
MPI_Send(sendbuf + sdispls[i], sendcounts[i], sendtypes[i], i, ...),
```

and received a message from every other process with a call to

```
MPI_Recv(recvbuf + rdispls[i], recvcounst[i], recvtypes[i], i, ...).
```

All arguments on all processes are significant. The argument `comm` must describe the same communicator on all processes.

Like for MPI_ALLTOALLV, the “in place” option for intracommunicators is specified by passing MPI_IN_PLACE to the argument `sendbuf` at *all* processes. In such a case, `sendcounts`, `sdispls` and `sendtypes` are ignored. The data to be sent is taken from the `recvbuf` and replaced by the received data. Data sent and received must have the same type map as specified by the `recvcounst` and `recvtypes` arrays, and is taken from the locations of the receive buffer specified by `rdispls`.

If `comm` is an intercommunicator, then the outcome is as if each process in group A sends a message to each process in group B, and vice versa. The j -th send buffer of process i in group A should be consistent with the i -th receive buffer of process j in group B, and vice versa.

Rationale. The MPI_ALLTOALLW function generalizes several MPI functions by carefully selecting the input arguments. For example, by making all but one process have `sendcounts[i] = 0`, this achieves an MPI_SCATTERW function. (*End of rationale.*)

5.9 Global Reduction Operations

The functions in this section perform a global reduce operation (for example sum, maximum, and logical and) across all members of a group. The reduction operation can be either one of a predefined list of operations, or a user-defined operation. The global reduction functions come in several flavors: a reduce that returns the result of the reduction to one member of a group, an all-reduce that returns this result to all members of a group, and two scan (parallel

1 prefix) operations. In addition, a reduce-scatter operation combines the functionality of a
 2 reduce and of a scatter operation.

4 5.9.1 Reduce

7 MPI_REDUCE(sendbuf, recvbuf, count, datatype, op, root, comm)

9	IN	sendbuf	address of send buffer (choice)
10	OUT	recvbuf	address of receive buffer (choice, significant only at 11 root)
12	IN	count	number of elements in send buffer (non-negative inte- 13 ger)
14	IN	datatype	data type of elements of send buffer (handle)
15	IN	op	reduce operation (handle)
16	IN	root	rank of root process (integer)
17	IN	comm	communicator (handle)

20
 ticket140. 21 int MPI_Reduce(const void* sendbuf, void* recvbuf, int count,
 22 MPI_Datatype datatype, MPI_Op op, int root, MPI_Comm comm)

ticket-248T. 23 MPI_Reduce(sendbuf, recvbuf, count, datatype, op, root, comm, ierror)

24 BIND(C)

25 TYPE(*), DIMENSION(..), INTENT(IN) :: sendbuf

26 TYPE(*), DIMENSION(..) :: recvbuf

27 INTEGER, INTENT(IN) :: count, root

28 TYPE(MPI_Datatype), INTENT(IN) :: datatype

29 TYPE(MPI_Op), INTENT(IN) :: op

30 TYPE(MPI_Comm), INTENT(IN) :: comm

31 INTEGER, OPTIONAL, INTENT(OUT) :: ierror

32
 33 MPI_REDUCE(SENDBUF, RECVBUF, COUNT, DATATYPE, OP, ROOT, COMM, IERROR)

34 <type> SENDBUF(*), RECVBUF(*)

35 INTEGER COUNT, DATATYPE, OP, ROOT, COMM, IERROR

36
 37 {void MPI::Comm::Reduce(const void* sendbuf, void* recvbuf, int count,
 38 const MPI::Datatype& datatype, const MPI::Op& op, int root)
 39 const = 0(binding deprecated, see Section 15.2) }

40 If comm is an intracommunicator, MPI_REDUCE combines the elements provided in the
 41 input buffer of each process in the group, using the operation op, and returns the combined
 42 value in the output buffer of the process with rank root. The input buffer is defined by
 43 the arguments sendbuf, count and datatype; the output buffer is defined by the arguments
 44 recvbuf, count and datatype; both have the same number of elements, with the same type.
 45 The routine is called by all group members using the same arguments for count, datatype, op,
 ticket0. 46 root and comm. Thus, all processes provide input buffers [and output buffers] of the same
 ticket0. 47 length, with elements of the same type[.] as the output buffer at the root. Each process
 48 can provide one element, or a sequence of elements, in which case the combine operation

is executed element-wise on each entry of the sequence. For example, if the operation is `MPI_MAX` and the send buffer contains two elements that are floating point numbers (`count = 2` and `datatype = MPI_FLOAT`), then `recvbuf(1) = global max(sendbuf(1))` and `recvbuf(2) = global max(sendbuf(2))`.

Section 5.9.2, lists the set of predefined operations provided by MPI. That section also enumerates the datatypes to which each operation can be applied.

In addition, users may define their own operations that can be overloaded to operate on several datatypes, either basic or derived. This is further explained in Section 5.9.5.

The operation `op` is always assumed to be associative. All predefined operations are also assumed to be commutative. Users may define operations that are assumed to be associative, but not commutative. The “canonical” evaluation order of a reduction is determined by the ranks of the processes in the group. However, the implementation can take advantage of associativity, or associativity and commutativity in order to change the order of evaluation. This may change the result of the reduction for operations that are not strictly associative and commutative, such as floating point addition.

Advice to implementors. It is strongly recommended that `MPI_REDUCE` be implemented so that the same result be obtained whenever the function is applied on the same arguments, appearing in the same order. Note that this may prevent optimizations that take advantage of the physical location of `[processors]ranks`. (*End of advice to implementors.*)

Advice to users. Some applications may not be able to ignore the non-associative nature of floating-point operations or may use user-defined operations (see Section 5.9.5) that require a special reduction order and cannot be treated as associative. Such applications should enforce the order of evaluation explicitly. For example, in the case of operations that require a strict left-to-right (or right-to-left) evaluation order, this could be done by gathering all operands at a single process (e.g., with `MPI_GATHER`), applying the reduction operation in the desired order (e.g., with `MPI_REDUCE_LOCAL`), and if needed, broadcast or scatter the result to the other processes (e.g., with `MPI_BCAST`). (*End of advice to users.*)

The `datatype` argument of `MPI_REDUCE` must be compatible with `op`. Predefined operators work only with the MPI types listed in Section 5.9.2 and Section 5.9.4. Furthermore, the `datatype` and `op` given for predefined operators must be the same on all processes.

Note that it is possible for users to supply different user-defined operations to `MPI_REDUCE` in each process. MPI does not define which operations are used on which operands in this case. User-defined operators may operate on general, derived datatypes. In this case, each argument that the reduce operation is applied to is one element described by such a datatype, which may contain several basic values. This is further explained in Section 5.9.5.

Advice to users. Users should make no assumptions about how `MPI_REDUCE` is implemented. It is safest to ensure that the same function is passed to `MPI_REDUCE` by each process. (*End of advice to users.*)

Overlapping datatypes are permitted in “send” buffers. Overlapping datatypes in “receive” buffers are erroneous and may give unpredictable results.

1 The “in place” option for intracommunicators is specified by passing the value
 2 MPI_IN_PLACE to the argument `sendbuf` at the root. In such a case, the input data is taken
 3 at the root from the receive buffer, where it will be replaced by the output data.

4 If `comm` is an intercommunicator, then the call involves all processes in the intercom-
 5 municator, but with one group (group A) defining the root process. All processes in the
 6 other group (group B) pass the same value in argument `root`, which is the rank of the root
 7 in group A. The root passes the value MPI_ROOT in `root`. All other processes in group A
 8 pass the value MPI_PROC_NULL in `root`. Only send buffer arguments are significant in group
 9 B and only receive buffer arguments are significant at the root.

11 5.9.2 Predefined Reduction Operations

12 The following predefined operations are supplied for MPI_REDUCE and related functions
 13 MPI_ALLREDUCE, MPI_REDUCE_SCATTER_BLOCK, MPI_REDUCE_SCATTER,
 14 MPI_SCAN, [and] MPI_EXSCAN, all nonblocking variants of those (see Section 5.12), and
 15 MPI_REDUCE_LOCAL. These operations are invoked by placing the following in `op`.
 16

18 Name	19 Meaning
20 MPI_MAX	21 maximum
22 MPI_MIN	23 minimum
24 MPI_SUM	25 sum
26 MPI_PROD	27 product
28 MPI_LAND	29 logical and
30 MPI_BAND	31 bit-wise and
32 MPI_LOR	33 logical or
34 MPI BOR	35 bit-wise or
36 MPI_LXOR	37 logical exclusive or (xor)
38 MPI_BXOR	39 bit-wise exclusive or (xor)
40 MPI_MAXLOC	41 max value and location
42 MPI_MINLOC	43 min value and location

32 The two operations MPI_MINLOC and MPI_MAXLOC are discussed separately in Sec-
 33 tion 5.9.4. For the other predefined operations, we enumerate below the allowed combi-
 34 nations of `op` and `datatype` arguments. First, define groups of MPI basic datatypes in the
 35 following way.
 36

38 C integer:	39 MPI_INT, MPI_LONG, MPI_SHORT, 40 MPI_UNSIGNED_SHORT, MPI_UNSIGNED, 41 MPI_UNSIGNED_LONG, 42 MPI_LONG_LONG_INT, 43 MPI_LONG_LONG (as synonym), 44 MPI_UNSIGNED_LONG_LONG, 45 MPI_SIGNED_CHAR, 46 MPI_UNSIGNED_CHAR, 47 MPI_INT8_T, MPI_INT16_T, 48 MPI_INT32_T, MPI_INT64_T, MPI_UINT8_T, MPI_UINT16_T,
---------------	---

ticket265. Fortran integer: MPI_UINT32_T, MPI_UINT64_T 1
 MPI_INTEGER, MPI_AINT, MPI_COUNT, 2
 MPI_OFFSET, 3
 and handles returned from 4
 MPI_TYPE_CREATE_F90_INTEGER, 5
 and if available: MPI_INTEGER1, 6
 MPI_INTEGER2, MPI_INTEGER4, 7
 MPI_INTEGER8, MPI_INTEGER16 8
 Floating point: MPI_FLOAT, MPI_DOUBLE, MPI_REAL, 9
 MPI_DOUBLE_PRECISION 10
 MPI_LONG_DOUBLE 11
 and handles returned from 12
 MPI_TYPE_CREATE_F90_REAL, 13
 and if available: MPI_REAL2, 14
 MPI_REAL4, MPI_REAL8, MPI_REAL16 15
 Logical: MPI_LOGICAL, MPI_C_BOOL 16
 Complex: MPI_COMPLEX, 17
 MPI_C_FLOAT_COMPLEX, 18
 MPI_C_DOUBLE_COMPLEX, 19
 MPI_C_LONG_DOUBLE_COMPLEX, 20
 and handles returned from 21
 MPI_TYPE_CREATE_F90_COMPLEX, 22
 and if available: MPI_DOUBLE_COMPLEX, 23
 MPI_COMPLEX4, MPI_COMPLEX8, 24
 MPI_COMPLEX16, MPI_COMPLEX32 25
 Byte: MPI_BYTE 26

Now, the valid datatypes for each option [is]are specified below. 27

Op	Allowed Types
MPI_MAX, MPI_MIN	C integer, Fortran integer, Floating point
MPI_SUM, MPI_PROD	C integer, Fortran integer, Floating point, Complex
MPI_LAND, MPI_LOR, MPI_LXOR	C integer, Logical
MPI_BAND, MPI_BOR, MPI_BXOR	C integer, Fortran integer, Byte

The following examples use intracommunicators. 35

Example 5.15

A routine that computes the dot product of two vectors that are distributed across a group of processes and returns the answer at node zero. 38

```

1  SUBROUTINE PAR_BLAS1(m, a, b, c, comm)
2  REAL a(m), b(m)          ! local slice of array
3  REAL c                   ! result (at node zero)
4  REAL sum
5  INTEGER m, comm, i, ierr
6
7  ! local sum
8  sum = 0.0
9  DO i = 1, m
10     sum = sum + a(i)*b(i)
11 END DO
12
13 ! global sum
14 CALL MPI_REDUCE(sum, c, 1, MPI_REAL, MPI_SUM, 0, comm, ierr)
15 RETURN
16 END
17
18
19

```

Example 5.16

A routine that computes the product of a vector and an array that are distributed across a group of processes and returns the answer at node zero.

```

22 SUBROUTINE PAR_BLAS2(m, n, a, b, c, comm)
23 REAL a(m), b(m,n)      ! local slice of array
24 REAL c(n)              ! result
25 REAL sum(n)
26 INTEGER n, comm, i, j, ierr
27
28 ! local sum
29 DO j= 1, n
30     sum(j) = 0.0
31     DO i = 1, m
32         sum(j) = sum(j) + a(i)*b(i,j)
33     END DO
34 END DO
35
36 ! global sum
37 CALL MPI_REDUCE(sum, c, n, MPI_REAL, MPI_SUM, 0, comm, ierr)
38
39 ! return result at node zero (and garbage at the other nodes)
40 RETURN
41 END
42
43

```

5.9.3 Signed Characters and Reductions

The types `MPI_SIGNED_CHAR` and `MPI_UNSIGNED_CHAR` can be used in reduction operations. `MPI_CHAR`, `MPI_WCHAR`, and `MPI_CHARACTER` (which represent printable characters) cannot be used in reduction operations. In a heterogeneous environment, `MPI_CHAR`, `MPI_WCHAR`, and `MPI_CHARACTER` will be translated so as to preserve the printable

character, whereas `MPI_SIGNED_CHAR` and `MPI_UNSIGNED_CHAR` will be translated so as to preserve the integer value.

Advice to users. The types `MPI_CHAR`, `MPI_WCHAR`, and `MPI_CHARACTER` are intended for characters, and so will be translated to preserve the printable representation, rather than the integer value, if sent between machines with different character codes. The types `MPI_SIGNED_CHAR` and `MPI_UNSIGNED_CHAR` should be used in C if the integer value should be preserved. (*End of advice to users.*)

5.9.4 MINLOC and MAXLOC

The operator `MPI_MINLOC` is used to compute a global minimum and also an index attached to the minimum value. `MPI_MAXLOC` similarly computes a global maximum and index. One application of these is to compute a global minimum (maximum) and the rank of the process containing this value.

The operation that defines `MPI_MAXLOC` is:

$$\begin{pmatrix} u \\ i \end{pmatrix} \circ \begin{pmatrix} v \\ j \end{pmatrix} = \begin{pmatrix} w \\ k \end{pmatrix}$$

where

$$w = \max(u, v)$$

and

$$k = \begin{cases} i & \text{if } u > v \\ \min(i, j) & \text{if } u = v \\ j & \text{if } u < v \end{cases}$$

`MPI_MINLOC` is defined similarly:

$$\begin{pmatrix} u \\ i \end{pmatrix} \circ \begin{pmatrix} v \\ j \end{pmatrix} = \begin{pmatrix} w \\ k \end{pmatrix}$$

where

$$w = \min(u, v)$$

and

$$k = \begin{cases} i & \text{if } u < v \\ \min(i, j) & \text{if } u = v \\ j & \text{if } u > v \end{cases}$$

Both operations are associative and commutative. Note that if `MPI_MAXLOC` is applied to reduce a sequence of pairs $(u_0, 0), (u_1, 1), \dots, (u_{n-1}, n-1)$, then the value returned is (u, r) , where $u = \max_i u_i$ and r is the index of the first global maximum in the sequence. Thus, if each process supplies a value and its rank within the group, then a reduce operation with `op = MPI_MAXLOC` will return the maximum value and the rank of the first process with that value. Similarly, `MPI_MINLOC` can be used to return a minimum and its index. More generally, `MPI_MINLOC` computes a *lexicographic minimum*, where elements are ordered

1 according to the first component of each pair, and ties are resolved according to the second
 2 component.

3 The reduce operation is defined to operate on arguments that consist of a pair: value
 4 and index. For both Fortran and C, types are provided to describe the pair. The potentially
 5 mixed-type nature of such arguments is a problem in Fortran. The problem is circumvented,
 6 for Fortran, by having the MPI-provided type consist of a pair of the same type as value,
 7 and coercing the index to this type also. In C, the MPI-provided pair type has distinct
 8 types and the index is an `int`.

9 In order to use `MPI_MINLOC` and `MPI_MAXLOC` in a reduce operation, one must provide
 10 a `datatype` argument that represents a pair (value and index). MPI provides nine such
 11 predefined datatypes. The operations `MPI_MAXLOC` and `MPI_MINLOC` can be used with
 12 each of the following datatypes.

13 Fortran:

14 Name	Description
15 <code>MPI_2REAL</code>	pair of <code>REAL</code> s
16 <code>MPI_2DOUBLE_PRECISION</code>	pair of <code>DOUBLE PRECISION</code> variables
17 <code>MPI_2INTEGER</code>	pair of <code>INTEGER</code> s

19 C:

20 Name	Description
21 <code>MPI_FLOAT_INT</code>	<code>float</code> and <code>int</code>
22 <code>MPI_DOUBLE_INT</code>	<code>double</code> and <code>int</code>
23 <code>MPI_LONG_INT</code>	<code>long</code> and <code>int</code>
24 <code>MPI_2INT</code>	pair of <code>int</code>
25 <code>MPI_SHORT_INT</code>	<code>short</code> and <code>int</code>
26 <code>MPI_LONG_DOUBLE_INT</code>	<code>long double</code> and <code>int</code>

27 The datatype `MPI_2REAL` is *as if* defined by the following (see Section 4.1).
 28

```
29 MPI_TYPE_CONTIGUOUS(2, MPI_REAL, MPI_2REAL)
```

30 Similar statements apply for `MPI_2INTEGER`, `MPI_2DOUBLE_PRECISION`, and `MPI_2INT`.

31 The datatype `MPI_FLOAT_INT` is *as if* defined by the following sequence of instructions.

```
32
33 type[0] = MPI_FLOAT
34 type[1] = MPI_INT
35 disp[0] = 0
36 disp[1] = sizeof(float)
37 block[0] = 1
38 block[1] = 1
39 MPI_TYPE_CREATE_STRUCT(2, block, disp, type, MPI_FLOAT_INT)
```

40 Similar statements apply for `MPI_LONG_INT` and `MPI_DOUBLE_INT`.

41 The following examples use intracommunicators.

42 Example 5.17

43 Each process has an array of 30 `doubles`, in C. For each of the 30 locations, compute
 44 the value and rank of the process containing the largest value.
 45

```

...
/* each process has an array of 30 double: ain[30]
*/
double ain[30], aout[30];
int ind[30];
struct {
    double val;
    int rank;
} in[30], out[30];
int i, myrank, root;

MPI_Comm_rank(comm, &myrank);
for (i=0; i<30; ++i) {
    in[i].val = ain[i];
    in[i].rank = myrank;
}
MPI_Reduce(in, out, 30, MPI_DOUBLE_INT, MPI_MAXLOC, root, comm);
/* At this point, the answer resides on process root
*/
if (myrank == root) {
    /* read ranks out
    */
    for (i=0; i<30; ++i) {
        aout[i] = out[i].val;
        ind[i] = out[i].rank;
    }
}

```

Example 5.18

Same example, in Fortran.

```

...
! each process has an array of 30 double: ain(30)

DOUBLE PRECISION ain(30), aout(30)
INTEGER ind(30)
DOUBLE PRECISION in(2,30), out(2,30)
INTEGER i, myrank, root, ierr

CALL MPI_COMM_RANK(comm, myrank, ierr)
DO I=1, 30
    in(1,i) = ain(i)
    in(2,i) = myrank ! myrank is coerced to a double
END DO

CALL MPI_REDUCE(in, out, 30, MPI_2DOUBLE_PRECISION, MPI_MAXLOC, root,
               comm, ierr)

```

```

1      ! At this point, the answer resides on process root
2
3      IF (myrank .EQ. root) THEN
4          ! read ranks out
5          DO I= 1, 30
6              aout(i) = out(1,i)
7              ind(i) = out(2,i) ! rank is coerced back to an integer
8          END DO
9      END IF

```

Example 5.19

Each process has a non-empty array of values. Find the minimum global value, the rank of the process that holds it and its index on this process.

```

15 #define LEN 1000
16
17 float val[LEN];          /* local array of values */
18 int count;              /* local number of values */
19 int myrank, minrank, minindex;
20 float minval;
21
22 struct {
23     float value;
24     int index;
25 } in, out;
26
27     /* local minloc */
28 in.value = val[0];
29 in.index = 0;
30 for (i=1; i < count; i++)
31     if (in.value > val[i]) {
32         in.value = val[i];
33         in.index = i;
34     }
35
36     /* global minloc */
37 MPI_Comm_rank(comm, &myrank);
38 in.index = myrank*LEN + in.index;
39 MPI_Reduce( &in, &out, 1, MPI_FLOAT_INT, MPI_MINLOC, root, comm );
40     /* At this point, the answer resides on process root
41     */
42 if (myrank == root) {
43     /* read answer out
44     */
45     minval = out.value;
46     minrank = out.index / LEN;
47     minindex = out.index % LEN;
48 }

```

Rationale. The definition of MPI_MINLOC and MPI_MAXLOC given here has the advantage that it does not require any special-case handling of these two operations: they are handled like any other reduce operation. A programmer can provide his or her own definition of MPI_MAXLOC and MPI_MINLOC, if so desired. The disadvantage is that values and indices have to be first interleaved, and that indices and values have to be coerced to the same type, in Fortran. (*End of rationale.*)

5.9.5 User-Defined Reduction Operations

MPI_OP_CREATE([\[function\]](#)user_fn, commute, op)

IN [\[ticket252-W.\]](#)[\[function\]](#)user_fn user defined function (function)
 IN commute true if commutative; false otherwise.
 OUT op operation (handle)

```
int MPI_Op_create(MPI_User_function* \[function\]user_fn, int commute,
                 MPI_Op* op)
```

```
MPI_Op_create(user_fn, commute, op, ierror) BIND(C)
  PROCEDURE(MPI_User_function) :: user_fn
  LOGICAL, INTENT(IN) :: commute
  TYPE(MPI_Op), INTENT(OUT) :: op
  INTEGER, OPTIONAL, INTENT(OUT) :: ierror
```

```
MPI_OP_CREATE( \[FUNCTION\]USER_FN, COMMUTE, OP, IERROR)
  EXTERNAL \[FUNCTION\]USER_FN
  LOGICAL COMMUTE
  INTEGER OP, IERROR
```

```
{void MPI::Op::Init(MPI::User_function* \[function\]user_fn,
                   bool commute) (binding deprecated, see Section 15.2) }
```

MPI_OP_CREATE binds a user-defined reduction operation to an op handle that can subsequently be used in MPI_REDUCE, MPI_ALLREDUCE, MPI_REDUCE_SCATTER_BLOCK, MPI_REDUCE_SCATTER, MPI_SCAN, [MPI_EXSCAN, all nonblocking variants of those (see Section 5.12), and MPI_REDUCE_LOCAL. The user-defined operation is assumed to be associative. If commute = true, then the operation should be both commutative and associative. If commute = false, then the order of operands is fixed and is defined to be in ascending, process rank order, beginning with process zero. The order of evaluation can be changed, taking advantage of the associativity of the operation. If commute = true then the order of evaluation can be changed, taking advantage of commutativity and associativity.

The argument [\[function\]](#)user_fn is the user-defined function, which must have the following four arguments: invec, inoutvec, len and datatype.

The ISO C prototype for the function is the following.

```
typedef void MPI_User_function(void* invec, void* inoutvec, int *len,
                               MPI_Datatype *datatype);
```

The Fortran declarations of the user-defined function `user_fn` appear[s] below.

```

1  ABSTRACT INTERFACE
2  SUBROUTINE MPI_User_function(invec, inoutvec, len, datatype) BIND(C)
3  USE, INTRINSIC :: ISO_C_BINDING, ONLY : C_PTR
4  TYPE(C_PTR), VALUE :: invec, inoutvec
5  INTEGER :: len
6  TYPE(MPI_Datatype) :: datatype
7
8  SUBROUTINE USER_FUNCTION(INVEC, INOUTVEC, LEN, [TYPE]DATATYPE)
9  <type> INVEC(LEN), INOUTVEC(LEN)
10  INTEGER LEN, [TYPE]DATATYPE
11

```

The C++ declaration of the user-defined function appears below.

```

12  {typedef void MPI::User_function(const void* invec, void* inoutvec, int
13  len, const Datatype& datatype); (binding deprecated, see
14  Section 15.2)}
15

```

The `datatype` argument is a handle to the data type that was passed into the call to `MPI_REDUCE`. The user reduce function should be written such that the following holds: Let `u[0], ... , u[len-1]` be the `len` elements in the communication buffer described by the arguments `invec`, `len` and `datatype` when the function is invoked; let `v[0], ... , v[len-1]` be `len` elements in the communication buffer described by the arguments `inoutvec`, `len` and `datatype` when the function is invoked; let `w[0], ... , w[len-1]` be `len` elements in the communication buffer described by the arguments `inoutvec`, `len` and `datatype` when the function returns; then `w[i] = u[i]o v[i]`, for `i=0, ... , len-1`, where `o` is the reduce operation that the function computes.

Informally, we can think of `invec` and `inoutvec` as arrays of `len` elements that `[function]user_fn` is combining. The result of the reduction over-writes values in `inoutvec`, hence the name. Each invocation of the function results in the pointwise evaluation of the reduce operator on `len` elements: i.e., the function returns in `inoutvec[i]` the value `invec[i] o inoutvec[i]`, for `i = 0, ... , count - 1`, where `o` is the combining operation computed by the function.

Rationale. The `len` argument allows `MPI_REDUCE` to avoid calling the function for each element in the input buffer. Rather, the system can choose to apply the function to chunks of input. In C, it is passed in as a reference for reasons of compatibility with Fortran.

By internally comparing the value of the `datatype` argument to known, global handles, it is possible to overload the use of a single user-defined function for several, different data types. (*End of rationale.*)

General datatypes may be passed to the user function. However, use of datatypes that are not contiguous is likely to lead to inefficiencies.

No MPI communication function may be called inside the user function. `MPI_ABORT` may be called inside the function in case of an error.

Advice to users. Suppose one defines a library of user-defined reduce functions that are overloaded: the `datatype` argument is used to select the right execution path at each invocation, according to the types of the operands. The user-defined reduce function

cannot “decode” the `datatype` argument that it is passed, and cannot identify, by itself, the correspondence between the `datatype` handles and the `datatype` they represent. This correspondence was established when the `datatypes` were created. Before the library is used, a library initialization preamble must be executed. This preamble code will define the `datatypes` that are used by the library, and store handles to these `datatypes` in global, static variables that are shared by the user code and the library code.

The Fortran version of `MPI_REDUCE` will invoke a user-defined reduce function using the Fortran calling conventions and will pass a Fortran-type `datatype` argument; the C version will use C calling convention and the C representation of a `datatype` handle. Users who plan to mix languages should define their reduction functions accordingly. (*End of advice to users.*)

Advice to implementors. We outline below a naive and inefficient implementation of `MPI_REDUCE` not supporting the “in place” option.

```

MPI_Comm_size(comm, &groupsize);
MPI_Comm_rank(comm, &rank);
if (rank > 0) {
    MPI_Recv(tempbuf, count, datatype, rank-1,...);
    User_reduce(tempbuf, sendbuf, count, datatype);
}
if (rank < groupsize-1) {
    MPI_Send(sendbuf, count, datatype, rank+1, ...);
}
/* answer now resides in process groupsize-1 ... now send to root
*/
if (rank == root) {
    MPI_Irecv(recvbuf, count, datatype, groupsize-1,..., &req);
}
if (rank == groupsize-1) {
    MPI_Send(sendbuf, count, datatype, root, ...);
}
if (rank == root) {
    MPI_Wait(&req, &status);
}

```

The reduction computation proceeds, sequentially, from process 0 to process `groupsize-1`. This order is chosen so as to respect the order of a possibly non-commutative operator defined by the function `User_reduce()`. A more efficient implementation is achieved by taking advantage of associativity and using a logarithmic tree reduction. Commutativity can be used to advantage, for those cases in which the `commute` argument to `MPI_OP_CREATE` is true. Also, the amount of temporary buffer required can be reduced, and communication can be pipelined with computation, by transferring and reducing the elements in chunks of size `len < count`.

The predefined reduce operations can be implemented as a library of user-defined operations. However, better performance might be achieved if `MPI_REDUCE` handles these functions as a special case. (*End of advice to implementors.*)

```

1 MPI_OP_FREE(op)
2     INOUT   op                       operation (handle)
3

```

```

4
5 int MPI_Op_free(MPI_Op *op)
6 MPI_Op_free(op, ierror) BIND(C)
7     TYPE(MPI_Op), INTENT(INOUT) :: op
8     INTEGER, OPTIONAL, INTENT(OUT) :: ierror
9

```

```

10 MPI_OP_FREE(OP, IERROR)
11     INTEGER OP, IERROR

```

```

12 {void MPI::Op::Free() (binding deprecated, see Section 15.2) }
13

```

14 Marks a user-defined reduction operation for deallocation and sets `op` to `MPI_OP_NULL`.

15 Example of User-defined Reduce

16 It is time for an example of user-defined reduction. The example in this section uses an intracommunicator.

17 **Example 5.20** Compute the product of an array of complex numbers, in C.

```

18
19
20
21
22 typedef struct {
23     double real,imag;
24 } Complex;
25
26 /* the user-defined function
27 */
28 void myProd(void *inP, void *inoutP, int *len, MPI_Datatype *dptr)
29 {
30     int i;
31     Complex c;
32     Complex *in = (Complex *)inP, *inout = (Complex *)inoutP;
33
34     for (i=0; i< *len; ++i) {
35         c.real = inout->real*in->real -
36             inout->imag*in->imag;
37         c.imag = inout->real*in->imag +
38             inout->imag*in->real;
39         *inout = c;
40         inout++;
41     }
42 }
43
44 /* and, to call it...
45 */
46 ...
47
48     /* each process has an array of 100 Complexes

```

```

    */
Complex a[100], answer[100];
MPI_Op myOp;
MPI_Datatype ctype;

/* explain to MPI how type Complex is defined
*/
MPI_Type_contiguous(2, MPI_DOUBLE, &ctype);
MPI_Type_commit(&ctype);
/* create the complex-product user-op
*/
MPI_Op_create( myProd, 1, &myOp );

MPI_Reduce(a, answer, 100, ctype, myOp, root, comm);

/* At this point, the answer, which consists of 100 Complexes,
* resides on process root
*/

```

Example 5.21 How to use the `mpi_f08` interface of the Fortran `MPI_User_function`.

```

subroutine my_user_function( invec, inoutvec, len, type )  bind(c)
  use, intrinsic :: iso_c_binding, only : c_ptr, c_f_pointer
  type(c_ptr), value :: invec, inoutvec
  integer :: len
  type(MPI_Datatype) :: type
  real, pointer :: invec_r(:), inoutvec_r(:)
  if (type%MPI_VAL == MPI_REAL%MPI_VAL) then
    call c_f_pointer(invec, invec_r, (/ len /) )
    call c_f_pointer(inoutvec, inoutvec_r, (/ len /) )
    inoutvec_r = invec_r + inoutvec_r
  end if
end subroutine

```

5.9.6 All-Reduce

MPI includes a variant of the reduce operations where the result is returned to all processes in a group. MPI requires that all processes from the same group participating in these operations receive identical results.

```

1 MPI_ALLREDUCE(sendbuf, recvbuf, count, datatype, op, comm)
2     IN      sendbuf      starting address of send buffer (choice)
3
4     OUT     recvbuf      starting address of receive buffer (choice)
5
6     IN      count        number of elements in send buffer (non-negative inte-
7                          ger)
8
9     IN      datatype     data type of elements of send buffer (handle)
10
11    IN      op            operation (handle)
12
13    IN      comm         communicator (handle)

```

```

ticket140. 12 int MPI_Allreduce(const void* sendbuf, void* recvbuf, int count,
ticket-248T. 13                MPI_Datatype datatype, MPI_Op op, MPI_Comm comm)
14
15 MPI_Allreduce(sendbuf, recvbuf, count, datatype, op, comm, ierror) BIND(C)
16     TYPE(*), DIMENSION(..), INTENT(IN) :: sendbuf
17     TYPE(*), DIMENSION(..) :: recvbuf
18     INTEGER, INTENT(IN) :: count
19     TYPE(MPI_Datatype), INTENT(IN) :: datatype
20     TYPE(MPI_Op), INTENT(IN) :: op
21     TYPE(MPI_Comm), INTENT(IN) :: comm
22     INTEGER, OPTIONAL, INTENT(OUT) :: ierror
23
24 MPI_ALLREDUCE(SENDBUF, RECVBUF, COUNT, DATATYPE, OP, COMM, IERROR)
25     <type> SENDBUF(*), RECVBUF(*)
26     INTEGER COUNT, DATATYPE, OP, COMM, IERROR
27
28 {void MPI::Comm::Allreduce(const void* sendbuf, void* recvbuf, int count,
29                          const MPI::Datatype& datatype, const MPI::Op& op)
30                          const = 0(binding deprecated, see Section 15.2) }

```

If `comm` is an intracommunicator, `MPI_ALLREDUCE` behaves the same as `MPI_REDUCE` except that the result appears in the receive buffer of all the group members.

Advice to implementors. The all-reduce operations can be implemented as a reduce, followed by a broadcast. However, a direct implementation can lead to better performance. (*End of advice to implementors.*)

The “in place” option for intracommunicators is specified by passing the value `MPI_IN_PLACE` to the argument `sendbuf` at all processes. In this case, the input data is taken at each process from the receive buffer, where it will be replaced by the output data.

If `comm` is an intercommunicator, then the result of the reduction of the data provided by processes in group A is stored at each process in group B, and vice versa. Both groups should provide `count` and `datatype` arguments that specify the same type signature.

The following example uses an intracommunicator.

Example 5.22

A routine that computes the product of a vector and an array that are distributed across a group of processes and returns the answer at all nodes (see also Example 5.16).

```

SUBROUTINE PAR_BLAS2(m, n, a, b, c, comm)      1
REAL a(m), b(m,n)      ! local slice of array  2
REAL c(n)              ! result                3
REAL sum(n)            4
INTEGER n, comm, i, j, ierr                    5

! local sum                                           7
DO j= 1, n                                             8
  sum(j) = 0.0                                         9
  DO i = 1, m                                         10
    sum(j) = sum(j) + a(i)*b(i,j)                    11
  END DO                                             12
END DO                                             13

! global sum                                           15
CALL MPI_ALLREDUCE(sum, c, n, MPI_REAL, MPI_SUM, comm, ierr) 16

! return result at all nodes                           18
RETURN                                             19
END                                               20

```

5.9.7 Process-[\[l\]](#)Local [\[r\]](#)Reduction

The functions in this section are of importance to library implementors who may want to implement special reduction patterns that are otherwise not easily covered by the standard MPI operations.

The following function applies a reduction operator to local arguments.

MPI_REDUCE_LOCAL(inbuf, inoutbuf, count, datatype, op)

IN	inbuf	input buffer (choice)	
INOUT	inoutbuf	combined input and output buffer (choice)	
IN	count	number of elements in inbuf and inoutbuf buffers (non-negative integer)	
IN	datatype	data type of elements of inbuf and inoutbuf buffers (handle)	
IN	op	operation (handle)	

```

int MPI_Reduce_local(const void* inbuf, void* inoutbuf, int count,
                    MPI_Datatype datatype, MPI_Op op)

```

```

MPI_Reduce_local(inbuf, inoutbuf, count, datatype, op, ierror) BIND(C)
  TYPE(*), DIMENSION(..), INTENT(IN) :: inbuf
  TYPE(*), DIMENSION(..) :: inoutbuf
  INTEGER, INTENT(IN) :: count
  TYPE(MPI_Datatype), INTENT(IN) :: datatype
  TYPE(MPI_Op), INTENT(IN) :: op

```

```

1     INTEGER, OPTIONAL, INTENT(OUT) :: ierror
2
3 MPI_REDUCE_LOCAL(INBUF, INOUTBUF, COUNT, DATATYPE, OP, IERROR)
4     <type> INBUF(*), INOUTBUF(*)
5     INTEGER COUNT, DATATYPE, OP, IERROR
6
7 {void MPI::Op::Reduce_local(const void* inbuf, void* inoutbuf, int count,
8     const MPI::Datatype& datatype) const(binding deprecated, see
9     Section 15.2) }
```

The function applies the operation given by `op` element-wise to the elements of `inbuf` and `inoutbuf` with the result stored element-wise in `inoutbuf`, as explained for user-defined operations in Section 5.9.5. Both `inbuf` and `inoutbuf` (input as well as result) have the same number of elements given by `count` and the same datatype given by `datatype`. The `MPI_IN_PLACE` option is not allowed.

Reduction operations can be queried for their commutativity.

```

17 MPI_OP_COMMUTATIVE( op, commute)
18
19     IN         op                operation (handle)
20     OUT        commute           true if op is commutative, false otherwise (logical)
```

```

22 int MPI_Op_commutative(MPI_Op op, int *commute)
23
24 MPI_Op_commutative(op, commute, ierror) BIND(C)
25     TYPE(MPI_Op), INTENT(IN) :: op
26     LOGICAL, INTENT(OUT) :: commute
27     INTEGER, OPTIONAL, INTENT(OUT) :: ierror
28
29 MPI_OP_COMMUTATIVE(OP, COMMUTE, IERROR)
30     LOGICAL COMMUTE
31     INTEGER OP, IERROR
32
33 {bool MPI::Op::Is_commutative() const(binding deprecated, see Section 15.2) }
```

5.10 Reduce-Scatter

MPI includes variants of the reduce operations where the result is scattered to all processes in a group on return. One variant scatters equal-sized blocks to all processes, while another variant scatters blocks that may vary in size for each process.

5.10.1 MPI_REDUCE_SCATTER_BLOCK

MPI_REDUCE_SCATTER_BLOCK(sendbuf, recvbuf, recvcnt, datatype, op, comm)			4
IN	sendbuf	starting address of send buffer (choice)	6
OUT	recvbuf	starting address of receive buffer (choice)	7
IN	recvcnt	element count per block (non-negative integer)	8
IN	datatype	data type of elements of send and receive buffers (handle)	10
IN	op	operation (handle)	12
IN	comm	communicator (handle)	13

```
int MPI_Reduce_scatter_block(const void* sendbuf, void* recvbuf,
    int recvcnt, MPI_Datatype datatype, MPI_Op op,
    MPI_Comm comm)
```

```
MPI_Reduce_scatter_block(sendbuf, recvbuf, recvcnt, datatype, op, comm,
    ierror) BIND(C)
    TYPE(*), DIMENSION(..), INTENT(IN) :: sendbuf
    TYPE(*), DIMENSION(..) :: recvbuf
    INTEGER, INTENT(IN) :: recvcnt
    TYPE(MPI_Datatype), INTENT(IN) :: datatype
    TYPE(MPI_Op), INTENT(IN) :: op
    TYPE(MPI_Comm), INTENT(IN) :: comm
    INTEGER, OPTIONAL, INTENT(OUT) :: ierror
```

```
MPI_REDUCE_SCATTER_BLOCK(SENDBUF, RECVBUF, RECVCOUNT, DATATYPE, OP, COMM,
    IERROR)
    <type> SENDBUF(*), RECVBUF(*)
    INTEGER REVCOUNT, DATATYPE, OP, COMM, IERROR
```

```
{void MPI::Comm::Reduce_scatter_block(const void* sendbuf, void* recvbuf,
    int recvcnt, const MPI::Datatype& datatype,
    const MPI::Op& op) const = 0(binding deprecated, see Section 15.2) }
```

If `comm` is an intracommunicator, `MPI_REDUCE_SCATTER_BLOCK` first performs a global, element-wise reduction on vectors of `count = n*recvcnt` elements in the send buffers defined by `sendbuf`, `count` and `datatype`, using the operation `op`, where `n` is the number of processes in the group of `comm`. The routine is called by all group members using the same arguments for `recvcnt`, `datatype`, `op` and `comm`. The resulting vector is treated as `n` consecutive blocks of `recvcnt` elements that are scattered to the processes of the group. The `i`-th block is sent to process `i` and stored in the receive buffer defined by `recvbuf`, `recvcnt`, and `datatype`.

Advice to implementors. The `MPI_REDUCE_SCATTER_BLOCK` routine is functionally equivalent to: an `MPI_REDUCE` collective operation with `count` equal to `recvcnt*n`, followed by an `MPI_SCATTER` with `sendcount` equal to `recvcnt`. However, a direct implementation may run faster. (*End of advice to implementors.*)

ticket0. 1 The “in place” option for intracommunicators is specified by passing MPI_IN_PLACE
2 in the `sendbuf` argument on *all* processes. In this case, the input data is taken from the
3 receive buffer.

4 If `comm` is an intercommunicator, then the result of the reduction of the data provided
5 by processes in one group (group A) is scattered among processes in the other group (group
6 B) and vice versa. Within each group, all processes provide the same value for the `recvcount`
7 argument, and provide input vectors of `count = n*recvcount` elements stored in the send
8 buffers, where `n` is the size of the group. The number of elements `count` must be the same
9 for the two groups. The resulting vector from the other group is scattered in blocks of
10 `recvcount` elements among the processes in the group.

11
12 *Rationale.* The last restriction is needed so that the length of the send buffer of
13 one group can be determined by the local `recvcount` argument of the other group.
14 Otherwise, a communication is needed to figure out how many elements are reduced.
15 (*End of rationale.*)

17 5.10.2 MPI_REDUCE_SCATTER

18 MPI_REDUCE_SCATTER extends the functionality of MPI_REDUCE_SCATTER_BLOCK
19 such that the scattered blocks can vary in size. Block sizes are determined by the `recvcounts`
20 array, such that the *i*-th block contains `recvcounts[i]` elements.

21
22
23 MPI_REDUCE_SCATTER(`sendbuf`, `recvbuf`, `recvcounts`, `datatype`, `op`, `comm`)

24	IN	<code>sendbuf</code>	starting address of send buffer (choice)
25	OUT	<code>recvbuf</code>	starting address of receive buffer (choice)
26	IN	<code>recvcounts</code>	non-negative integer array (of length group size) specifying the number of elements of the result distributed to each process.
27	IN	<code>datatype</code>	data type of elements of send and receive buffers (handle)
28	IN	<code>op</code>	operation (handle)
29	IN	<code>comm</code>	communicator (handle)

30
31
32
33
34
35
36
37 `int MPI_Reduce_scatter(const void* sendbuf, void* recvbuf, const`
38 `int recvcounts[], MPI_Datatype datatype, MPI_Op op,`
39 `MPI_Comm comm)`

40 `MPI_Reduce_scatter(sendbuf, recvbuf, recvcounts, datatype, op, comm,`
41 `error) BIND(C)`
42 `TYPE(*), DIMENSION(..), INTENT(IN) :: sendbuf`
43 `TYPE(*), DIMENSION(..) :: recvbuf`
44 `INTEGER, INTENT(IN) :: recvcounts(*)`
45 `TYPE(MPI_Datatype), INTENT(IN) :: datatype`
46 `TYPE(MPI_Op), INTENT(IN) :: op`
47 `TYPE(MPI_Comm), INTENT(IN) :: comm`
48 `INTEGER, OPTIONAL, INTENT(OUT) :: error`

```

MPI_REDUCE_SCATTER(SENDBUF, RECVBUF, RECVCOUNTS, DATATYPE, OP, COMM,
                   IERROR)
<type> SENDBUF(*), RECVBUF(*)
INTEGER RECVCOUNTS(*), DATATYPE, OP, COMM, IERROR
{void MPI::Comm::Reduce_scatter(const void* sendbuf, void* recvbuf,
                               int recvcounts[], const MPI::Datatype& datatype,
                               const MPI::Op& op) const = 0(binding deprecated, see Section 15.2) }

```

If `comm` is an intracommunicator, `MPI_REDUCE_SCATTER` first performs a global, element-wise reduction on vectors of `count = $\sum_{i=0}^{n-1} \text{recvcounts}[i]$` elements in the send buffers defined by `sendbuf`, `count` and `datatype`, using the operation `op`, where `n` is the number of processes in the group of `comm`. The routine is called by all group members using the same arguments for `recvcounts`, `datatype`, `op` and `comm`. The resulting vector is treated as `n` consecutive blocks where the number of elements of the `i`-th block is `recvcounts[i]`. The blocks are scattered to the processes of the group. The `i`-th block is sent to process `i` and stored in the receive buffer defined by `recvbuf`, `recvcounts[i]` and `datatype`.

Advice to implementors. The `MPI_REDUCE_SCATTER` routine is functionally equivalent to: an `MPI_REDUCE` collective operation with `count` equal to the sum of `recvcounts[i]` followed by `MPI_SCATTERV` with `sendcounts` equal to `recvcounts`. However, a direct implementation may run faster. (*End of advice to implementors.*)

The “in place” option for intracommunicators is specified by passing `MPI_IN_PLACE` in the `sendbuf` argument. In this case, the input data is taken from the receive buffer. It is not required to specify the “in place” option on all processes, since the processes for which `recvcounts[i]==0` may not have allocated a receive buffer.

If `comm` is an intercommunicator, then the result of the reduction of the data provided by processes in one group (group A) is scattered among processes in the other group (group B), and vice versa. Within each group, all processes provide the same `recvcounts` argument, and provide input vectors of `count = $\sum_{i=0}^{n-1} \text{recvcounts}[i]$` elements stored in the send buffers, where `n` is the size of the group. The resulting vector from the other group is scattered in blocks of `recvcounts[i]` elements among the processes in the group. The number of elements count must be the same for the two groups.

Rationale. The last restriction is needed so that the length of the send buffer can be determined by the sum of the local `recvcounts` entries. Otherwise, a communication is needed to figure out how many elements are reduced. (*End of rationale.*)

5.11 Scan

5.11.1 Inclusive Scan

MPI_SCAN(sendbuf, recvbuf, count, datatype, op, comm)

IN	sendbuf	starting address of send buffer (choice)
OUT	recvbuf	starting address of receive buffer (choice)
IN	count	number of elements in input buffer (non-negative integer)
IN	datatype	data type of elements of input buffer (handle)
IN	op	operation (handle)
IN	comm	communicator (handle)

```
int MPI_Scan(const void* sendbuf, void* recvbuf, int count,
            MPI_Datatype datatype, MPI_Op op, MPI_Comm comm)
```

```
MPI_Scan(sendbuf, recvbuf, count, datatype, op, comm, ierror) BIND(C)
    TYPE(*), DIMENSION(..), INTENT(IN) :: sendbuf
    TYPE(*), DIMENSION(..) :: recvbuf
    INTEGER, INTENT(IN) :: count
    TYPE(MPI_Datatype), INTENT(IN) :: datatype
    TYPE(MPI_Op), INTENT(IN) :: op
    TYPE(MPI_Comm), INTENT(IN) :: comm
    INTEGER, OPTIONAL, INTENT(OUT) :: ierror
```

```
MPI_SCAN(SENDBUF, RECVBUF, COUNT, DATATYPE, OP, COMM, IERROR)
    <type> SENDBUF(*), RECVBUF(*)
    INTEGER COUNT, DATATYPE, OP, COMM, IERROR
```

```
{void MPI::Intracomm::Scan(const void* sendbuf, void* recvbuf, int count,
    const MPI::Datatype& datatype, const MPI::Op& op) const(binding
    deprecated, see Section 15.2) }
```

If `comm` is an intracommunicator, `MPI_SCAN` is used to perform a prefix reduction on data distributed across the group. The operation returns, in the receive buffer of the process with rank `i`, the reduction of the values in the send buffers of processes with ranks `0, . . . , i` (inclusive). The type of operations supported, their semantics, and the constraints on send and receive buffers are as for `MPI_REDUCE`.

The “in place” option for intracommunicators is specified by passing `MPI_IN_PLACE` in the `sendbuf` argument. In this case, the input data is taken from the receive buffer, and replaced by the output data.

This operation is invalid for intercommunicators.

5.11.2 Exclusive Scan

MPI_EXSCAN(sendbuf, recvbuf, count, datatype, op, comm)

IN	sendbuf	starting address of send buffer (choice)
OUT	recvbuf	starting address of receive buffer (choice)
IN	count	number of elements in input buffer (non-negative integer)
IN	datatype	data type of elements of input buffer (handle)
IN	op	operation (handle)
IN	comm	intracommunicator (handle)

```
int MPI_Exscan(const void* sendbuf, void* recvbuf, int count,
              MPI_Datatype datatype, MPI_Op op, MPI_Comm comm)
```

```
MPI_Exscan(sendbuf, recvbuf, count, datatype, op, comm, ierror) BIND(C)
  TYPE(*), DIMENSION(..), INTENT(IN) :: sendbuf
  TYPE(*), DIMENSION(..) :: recvbuf
  INTEGER, INTENT(IN) :: count
  TYPE(MPI_Datatype), INTENT(IN) :: datatype
  TYPE(MPI_Op), INTENT(IN) :: op
  TYPE(MPI_Comm), INTENT(IN) :: comm
  INTEGER, OPTIONAL, INTENT(OUT) :: ierror
```

```
MPI_EXSCAN(SENDBUF, RECVBUF, COUNT, DATATYPE, OP, COMM, IERROR)
  <type> SENDBUF(*), RECVBUF(*)
  INTEGER COUNT, DATATYPE, OP, COMM, IERROR
```

```
{void MPI::Intracomm::Exscan(const void* sendbuf, void* recvbuf, int count,
  const MPI::Datatype& datatype, const MPI::Op& op) const(binding
  deprecated, see Section 15.2) }
```

If `comm` is an intracommunicator, `MPI_EXSCAN` is used to perform a prefix reduction on data distributed across the group. The value in `recvbuf` on the process with rank 0 is undefined, and `recvbuf` is not significant on process 0. The value in `recvbuf` on the process with rank 1 is defined as the value in `sendbuf` on the process with rank 0. For processes with rank $i > 1$, the operation returns, in the receive buffer of the process with rank i , the reduction of the values in the send buffers of processes with ranks $0, \dots, i - 1$ (inclusive). The type of operations supported, their semantics, and the constraints on send and receive buffers, are as for `MPI_REDUCE`.

The “in place” option for intracommunicators is specified by passing `MPI_IN_PLACE` in the `sendbuf` argument. In this case, the input data is taken from the receive buffer, and replaced by the output data. The receive buffer on rank 0 is not changed by this operation.

This operation is invalid for intercommunicators.

Rationale. The exclusive scan is more general than the inclusive scan. Any inclusive scan operation can be achieved by using the exclusive scan and then locally combining

1 the local contribution. Note that for non-invertable operations such as MPI_MAX, the
 2 exclusive scan cannot be computed with the inclusive scan. (*End of rationale.*)

4 5.11.3 Example using MPI_SCAN

5 The example in this section uses an intracommunicator.

7 **Example 5.23**

8 This example uses a user-defined operation to produce a *segmented scan*. A segmented
 9 scan takes, as input, a set of values and a set of logicals, and the logicals delineate the
 10 various segments of the scan. For example:

12	<i>values</i>	v_1	v_2	v_3	v_4	v_5	v_6	v_7	v_8
13	<i>logicals</i>	0	0	1	1	1	0	0	1
14	<i>result</i>	v_1	$v_1 + v_2$	v_3	$v_3 + v_4$	$v_3 + v_4 + v_5$	v_6	$v_6 + v_7$	v_8

15 The operator that produces this effect is,

$$16 \quad \begin{pmatrix} u \\ i \end{pmatrix} \circ \begin{pmatrix} v \\ j \end{pmatrix} = \begin{pmatrix} w \\ j \end{pmatrix},$$

19 where,

$$21 \quad w = \begin{cases} u + v & \text{if } i = j \\ v & \text{if } i \neq j \end{cases}.$$

22 Note that this is a non-commutative operator. C code that implements it is given
 23 below.

```

24 typedef struct {
25     double val;
26     int log;
27 } SegScanPair;
28
29 /* the user-defined function
30 */
31 void segScan(SegScanPair *in, SegScanPair *inout, int *len,
32             MPI_Datatype *dptr)
33 {
34     int i;
35     SegScanPair c;
36
37     for (i=0; i< *len; ++i) {
38         if (in->log == inout->log)
39             c.val = in->val + inout->val;
40         else
41             c.val = inout->val;
42         c.log = inout->log;
43         *inout = c;
44         in++; inout++;
45     }
46 }
47
48 
```

Note that the inout argument to the user-defined function corresponds to the right-hand operand of the operator. When using this operator, we must be careful to specify that it is non-commutative, as in the following.

```

int i,base;
SegScanPair a, answer;
MPI_Op      myOp;
MPI_Datatype type[2] = {MPI_DOUBLE, MPI_INT};
MPI_Aint     disp[2];
int          blocklen[2] = { 1, 1};
MPI_Datatype sspair;

/* explain to MPI how type SegScanPair is defined
 */
MPI_Get_address( &a, disp);
MPI_Get_address( &a.log, disp+1);
base = disp[0];
for (i=0; i<2; ++i) disp[i] -= base;
MPI_Type_create_struct( 2, blocklen, disp, type, &sspair );
MPI_Type_commit( &sspair );
/* create the segmented-scan user-op
 */
MPI_Op_create(segScan, 0, &myOp);
...
MPI_Scan( &a, &answer, 1, sspair, myOp, comm );

```

1
2
3
4
5
6
7
8
9
10
11
12
13
14
15
16
17
18
19
20
21
22
23
24

25 ticket109.

5.12 Nonblocking Collective Operations

As described in Section 3.7, performance of many applications can be improved by overlapping communication and computation, and many systems enable this. Nonblocking collective operations combine the potential benefits of nonblocking point-to-point operations, to exploit overlap and to avoid synchronization, with the optimized implementation and message scheduling provided by collective operations [30, 34]. One way of doing this would be to perform a blocking collective operation in a separate thread. An alternative mechanism that often leads to better performance (e.g., avoids context switching, scheduler overheads, and thread management) is to use nonblocking collective communication [32].

The nonblocking collective communication model is similar to the model used for nonblocking point-to-point communication. A nonblocking call initiates a collective operation, which must be completed in a separate completion call. Once initiated, the operation may progress independently of any computation or other communication at participating processes. In this manner, nonblocking collective operations can mitigate possible synchronizing effects of collective operations by running them in the “background.” In addition to enabling communication-computation overlap, nonblocking collective operations can perform collective operations on overlapping communicators, which would lead to deadlocks with blocking operations. Their semantic advantages can also be useful in combination with point-to-point communication.

As in the nonblocking point-to-point case, all calls are local and return immediately, irrespective of the status of other processes. The call initiates the operation, which indicates

26
27
28
29
30
31
32
33
34
35
36
37
38
39
40
41
42
43
44
45
46
47
48

1 that the system may start to copy data out of the send buffer and into the receive buffer.
2 Once initiated, all associated send buffers and buffers associated with input arguments (such
3 as arrays of counts, displacements, or datatypes in the vector versions of the collectives)
4 should not be modified, and all associated receive buffers should not be accessed, until the
5 collective operation completes. The call returns a request handle, which must be passed to
6 a completion call.

7 All completion calls (e.g., `MPI_WAIT`) described in Section 3.7.3 are supported for
8 nonblocking collective operations. Similarly to the blocking case, nonblocking collective
9 operations are considered to be complete when the local part of the operation is finished,
10 i.e., for the caller, the semantics of the operation are guaranteed and all buffers can be
11 safely accessed and modified. Completion does not indicate that other processes have
12 completed or even started the operation (unless otherwise implied by the description of
13 the operation). Completion of a particular nonblocking collective operation also does not
14 indicate completion of any other posted nonblocking collective (or send-receive) operations,
15 whether they are posted before or after the completed operation.

16
17 *Advice to users.* Users should be aware that implementations are allowed, but
18 not required (with exception of `MPI_IBARRIER`), to synchronize processes during the
19 completion of a nonblocking collective operation. (*End of advice to users.*)

20
21 Upon returning from a completion call in which a nonblocking collective operation
22 completes, the `MPI_ERROR` field in the associated status object is set appropriately, see
23 Section 3.2.5 on page 34. The values of the `MPI_SOURCE` and `MPI_TAG` fields are undefined.
24 It is valid to mix different request types (i.e., any combination of collective requests, I/O
25 requests, generalized requests, or point-to-point requests) in functions that enable multiple
26 completions (e.g., `MPI_WAITALL`). It is erroneous to call `MPI_REQUEST_FREE` or
27 `MPI_CANCEL` for a request associated with a nonblocking collective operation. Nonblocking
28 collective requests are not persistent.

29
30 *Rationale.* Freeing an active nonblocking collective request could cause similar
31 problems as discussed for point-to-point requests (see Section 3.7.3). Cancelling a
32 request is not supported because the semantics of this operation are not well-defined.
33 (*End of rationale.*)

34
35 Multiple nonblocking collective operations can be outstanding on a single communi-
36 cator. If the nonblocking call causes some system resource to be exhausted, then it will
37 fail and generate an MPI exception. Quality implementations of MPI should ensure that
38 this happens only in pathological cases. That is, an MPI implementation should be able to
39 support a large number of pending nonblocking operations.

40
41 Unlike point-to-point operations, nonblocking collective operations do not match with
42 blocking collective operations, and collective operations do not have a tag argument. All
43 processes must call collective operations (blocking and nonblocking) in the same order
44 per communicator. In particular, once a process calls a collective operation, all other
45 processes in the communicator must eventually call the same collective operation, and no
46 other collective operation with the same communicator in between. This is consistent with
47 the ordering rules for blocking collective operations in threaded environments.

47
48 *Rationale.* Matching blocking and nonblocking collective operations is not allowed
because the implementation might use different communication algorithms for the two

cases. Blocking collective operations may be optimized for minimal time to completion, while nonblocking collective operations may balance time to completion with CPU overhead and asynchronous progression.

The use of tags for collective operations can prevent certain hardware optimizations. (*End of rationale.*)

Advice to users. If program semantics require matching blocking and nonblocking collective operations, then a nonblocking collective operation can be initiated and immediately completed with a blocking wait to emulate blocking behavior. (*End of advice to users.*)

In terms of data movements, each nonblocking collective operation has the same effect as its blocking counterpart for intracommunicators and intercommunicators after completion. Likewise, upon completion, nonblocking collective reduction operations have the same effect as their blocking counterparts, and the same restrictions and recommendations on reduction orders apply.

The use of the “in place” option is allowed exactly as described for the corresponding blocking collective operations. When using the “in place” option, message buffers function as both send and receive buffers. Such buffers should not be modified or accessed until the operation completes.

Progression rules for nonblocking collective operations are similar to progression of nonblocking point-to-point operations, refer to Section 3.7.4.

Advice to implementors. Nonblocking collective operations can be implemented with local execution schedules [33] using nonblocking point-to-point communication and a reserved tag-space. (*End of advice to implementors.*)

5.12.1 Nonblocking Barrier Synchronization

`MPI_IBARRIER(comm , request)`

IN	<code>comm</code>	communicator (handle)
OUT	<code>request</code>	communication request (handle)

`int MPI_Ibarrier(MPI_Comm comm, MPI_Request *request)`

`MPI_Ibarrier(comm, request, ierror) BIND(C)`
`TYPE(MPI_Comm), INTENT(IN) :: comm`
`TYPE(MPI_Request), INTENT(OUT) :: request`
`INTEGER, OPTIONAL, INTENT(OUT) :: ierror`

`MPI_IBARRIER(COMM, REQUEST, IERROR)`
`INTEGER COMM, REQUEST, IERROR`

[{`MPI::Request MPI::Comm::Ibarrier()` `const = 0`(*binding deprecated, see Section 15.2*) }

1
2
3
4
5
6
7
8
9
10
11
12
13
14
15
16
17
18
19
20
21
22
23
24
25
26
27
28
29
30
31
32
33
34
35
36
37
38
39
40
41
42
43
44
45
46
47
48

ticket-248T.

ticket272.

1]
 2 MPI_IBARRIER is a nonblocking version of MPI_BARRIER. By calling MPI_IBARRIER,
 3 a process notifies that it has reached the barrier. The call returns immediately, independ-
 4 ent of whether other processes have called MPI_IBARRIER. The usual barrier semantics
 5 are enforced at the corresponding completion operation (test or wait), which in the intra-
 6 communicator case will complete only after all other processes in the communicator have
 7 called MPI_IBARRIER. In the intercommunicator case, it will complete when all processes
 8 in the remote group have called MPI_IBARRIER.

9
 10 *Advice to users.* A nonblocking barrier can be used to hide latency. Moving independ-
 11 ent computations between the MPI_IBARRIER and the subsequent completion call
 12 can overlap the barrier latency and therefore shorten possible waiting times. The se-
 13 mantic properties are also useful when mixing collective operations and point-to-point
 14 messages. (*End of advice to users.*)

15 5.12.2 Nonblocking Broadcast

16 MPI_IBCAST(buffer, count, datatype, root, comm, request)

17	INOUT	buffer	starting address of buffer (choice)
18	IN	count	number of entries in buffer (non-negative integer)
19	IN	datatype	data type of buffer (handle)
20	IN	root	rank of broadcast root (integer)
21	IN	comm	communicator (handle)
22	OUT	request	communication request (handle)

23
 24
 25
 26
 27
 28
 29
 30 `int MPI_Ibcast(const void* buffer, int count, MPI_Datatype datatype,`
 31 `int root, MPI_Comm comm, MPI_Request *request)`

32 `MPI_Ibcast(buffer, count, datatype, root, comm, request, ierror) BIND(C)`
 33 `TYPE(*), DIMENSION(..), ASYNCHRONOUS :: buffer`
 34 `INTEGER, INTENT(IN) :: count, root`
 35 `TYPE(MPI_Datatype), INTENT(IN) :: datatype`
 36 `TYPE(MPI_Comm), INTENT(IN) :: comm`
 37 `TYPE(MPI_Request), INTENT(OUT) :: request`
 38 `INTEGER, OPTIONAL, INTENT(OUT) :: ierror`

39 `MPI_IBCAST(BUFFER, COUNT, DATATYPE, ROOT, COMM, REQUEST, IERROR)`
 40 `<type> BUFFER(*)`
 41 `INTEGER COUNT, DATATYPE, ROOT, COMM, REQUEST, IERROR`

42
 43 `[{MPI::Request MPI::Comm::Ibcast(void* buffer, int count,`
 44 `const MPI::Datatype& datatype, int root) const = 0(binding`
 45 `deprecated, see Section 15.2) }`
 46

47]
 48 This call starts a nonblocking variant of MPI_BCAST (see Section 5.4).

Example using MPI_IBCAST

The example in this section uses an intracommunicator.

Example 5.24

Start a broadcast of 100 ints from process 0 to every process in the group, perform some computation on independent data, and then complete the outstanding broadcast operation.

```
MPI_Comm comm;
int array1[100], array2[100];
int root=0;
MPI_Request req;
...
MPI_Ibcast(array1, 100, MPI_INT, root, comm, &req);
compute(array2, 100);
MPI_Wait(&req, MPI_STATUS_IGNORE);
```

5.12.3 Nonblocking Gather

`MPI_IGATHER(sendbuf, sendcount, sendtype, recvbuf, recvcount, recvtype, root, comm, request)`

IN	sendbuf	starting address of send buffer (choice)
IN	sendcount	number of elements in send buffer (non-negative integer)
IN	sendtype	data type of send buffer elements (handle)
OUT	recvbuf	address of receive buffer (choice, significant only at root)
IN	recvcount	number of elements for any single receive (non-negative integer, significant only at root)
IN	recvtype	data type of recv buffer elements (significant only at root) (handle)
IN	root	rank of receiving process (integer)
IN	comm	communicator (handle)
OUT	request	communication request (handle)

```
int MPI_Igather(const void* sendbuf, int sendcount, MPI_Datatype sendtype,
               void* recvbuf, int recvcount, MPI_Datatype recvtype, int root,
               MPI_Comm comm, MPI_Request *request)
```

```
MPI_Igather(sendbuf, sendcount, sendtype, recvbuf, recvcount, recvtype,
            root, comm, request, ierror) BIND(C)
TYPE(*), DIMENSION(..), INTENT(IN), ASYNCHRONOUS :: sendbuf
TYPE(*), DIMENSION(..), ASYNCHRONOUS :: recvbuf
INTEGER, INTENT(IN) :: sendcount, recvcount, root
TYPE(MPI_Datatype), INTENT(IN) :: sendtype, recvtype
```

1
2
3
4
5
6
7
8
9
10
11
12
13
14
15
16
17
18
19
20
21
22
23
24
25
26
27
28
29
30
31
32
33
34
35
36
37
38
39
40
41
42
43
44
45
46
47
48

ticket140.
ticket-248T.

```

1     TYPE(MPI_Comm), INTENT(IN) :: comm
2     TYPE(MPI_Request), INTENT(OUT) :: request
3     INTEGER, OPTIONAL, INTENT(OUT) :: ierror
4
5 MPI_IGATHER(SENDBUF, SENDCOUNT, SENDTYPE, RECVBUF, REVCOUNT, RECVTYPE,
6             ROOT, COMM, REQUEST, IERROR)
7     <type> SENDBUF(*), RECVBUF(*)
8     INTEGER SENDCOUNT, SENDTYPE, REVCOUNT, RECVTYPE, ROOT, COMM, REQUEST,
9     IERROR

```

```

10    [ {MPI::Request MPI::Comm::Igather(const void* sendbuf, int sendcount,
11        const MPI::Datatype& sendtype, void* recvbuf, int recvcoun,
12        const MPI::Datatype& recvtype, int root) const = 0(binding
13        deprecated, see Section 15.2) }
14
15    ]

```

This call starts a nonblocking variant of MPI_GATHER (see Section 5.5).

```

18 MPI_IGATHERV(sendbuf, sendcount, sendtype, recvbuf, recvcoun, displs, recvtype, root,
19             comm, request)

```

21	IN	sendbuf	starting address of send buffer (choice)
22	IN	sendcount	number of elements in send buffer (non-negative integer)
23			
24	IN	sendtype	data type of send buffer elements (handle)
25	OUT	recvbuf	address of receive buffer (choice, significant only at root)
26			
27			
28	IN	recvcoun	non-negative integer array (of length group size) containing the number of elements that are received from each process (significant only at root)
29			
30			
31	IN	displs	integer array (of length group size). Entry <i>i</i> specifies the displacement relative to <i>recvbuf</i> at which to place the incoming data from process <i>i</i> (significant only at root)
32			
33			
34			
35	IN	recvtype	data type of recv buffer elements (significant only at root) (handle)
36			
37			
38	IN	root	rank of receiving process (integer)
39	IN	comm	communicator (handle)
40	OUT	request	communication request (handle)
41			

```

42 int MPI_Igatherv(const void* sendbuf, int sendcount, MPI_Datatype sendtype,
43                void* recvbuf, const int recvcoun[], const int displs[],
44                MPI_Datatype recvtype, int root, MPI_Comm comm,
45                MPI_Request *request)

```

```

46 MPI_Igatherv(sendbuf, sendcount, sendtype, recvbuf, recvcoun, displs,
47             recvtype, root, comm, request, ierror) BIND(C)
48

```

```

TYPE(*), DIMENSION(..), INTENT(IN), ASYNCHRONOUS :: sendbuf      1
TYPE(*), DIMENSION(..), ASYNCHRONOUS :: recvbuf                2
INTEGER, INTENT(IN) :: sendcount, root                          3
INTEGER, INTENT(IN), ASYNCHRONOUS :: recvcnts(*), displs(*)     4
TYPE(MPI_Datatype), INTENT(IN) :: sendtype, recvtype           5
TYPE(MPI_Comm), INTENT(IN) :: comm                              6
TYPE(MPI_Request), INTENT(OUT) :: request                       7
INTEGER, OPTIONAL, INTENT(OUT) :: ierror                        8
                                                                9
MPI_IGATHERV(SENDBUF, SENDCOUNT, SENDTYPE, RECVBUF, RECVCOUNTS, DISPLS, 10
             RECVTYPE, ROOT, COMM, REQUEST, IERROR)            11
<type> SENDBUF(*), RECVBUF(*)                                  12
INTEGER SENDCOUNT, SENDTYPE, RECVCOUNTS(*), DISPLS(*), RECVTYPE, ROOT, 13
COMM, REQUEST, IERROR                                         14
                                                                ticket272.
[ {MPI::Request MPI::Comm::Igatherv(const void* sendbuf, int sendcount, 15
    const MPI::Datatype& sendtype, void* recvbuf,
    const int recvcnts[], const int displs[],
    const MPI::Datatype& recvtype, int root) const = 0(binding 16
    deprecated, see Section 15.2) }                             17
                                                                18
                                                                19
                                                                20
                                                                21
]
This call starts a nonblocking variant of MPI_GATHERV (see Section 5.5). 22

```

5.12.4 Nonblocking Scatter

```

MPI_ISCATTER(sendbuf, sendcount, sendtype, recvbuf, recvcnt, recvtype, root, comm, 27
             request)                                          28
                                                                29
IN          sendbuf      address of send buffer (choice, significant only at root) 30
IN          sendcount    number of elements sent to each process (non-negative 31
                        integer, significant only at root)      32
IN          sendtype     data type of send buffer elements (significant only at 33
                        root) (handle)                          34
OUT         recvbuf      address of receive buffer (choice)      35
IN          recvcnt      number of elements in receive buffer (non-negative in- 36
                        teger)                                   37
IN          recvtype     data type of receive buffer elements (handle) 38
IN          root         rank of sending process (integer)      39
IN          comm         communicator (handle)                  40
OUT         request      communication request (handle)         41
                                                                42
                                                                43
                                                                44
int MPI_Iscatter(const void* sendbuf, int sendcount, MPI_Datatype sendtype, 45
                void* recvbuf, int recvcnt, MPI_Datatype recvtype, int root, 46
                MPI_Comm comm, MPI_Request *request)           47
                                                                ticket140.
                                                                48
                                                                ticket-248T.

```

```

1 MPI_Isscatter(sendbuf, sendcount, sendtype, recvbuf, recvcount, recvtpe,
2               root, comm, request, ierror) BIND(C)
3     TYPE(*), DIMENSION(..), INTENT(IN), ASYNCHRONOUS :: sendbuf
4     TYPE(*), DIMENSION(..), ASYNCHRONOUS :: recvbuf
5     INTEGER, INTENT(IN) :: sendcount, recvcount, root
6     TYPE(MPI_Datatype), INTENT(IN) :: sendtype, recvtpe
7     TYPE(MPI_Comm), INTENT(IN) :: comm
8     TYPE(MPI_Request), INTENT(OUT) :: request
9     INTEGER, OPTIONAL, INTENT(OUT) :: ierror

```

```

10 MPI_ISCATTER(SENDBUF, SENDCOUNT, SENDTYPE, RECVBUF, RECVCOUNT, RECVTYPE,
11             ROOT, COMM, REQUEST, IERROR)
12 <type> SENDBUF(*), RECVBUF(*)
13 INTEGER SENDCOUNT, SENDTYPE, RECVCOUNT, RECVTYPE, ROOT, COMM, REQUEST,
14 IERROR

```

```

15 [ {MPI::Request MPI::Comm::Iscluster(const void* sendbuf, int sendcount,
16                                     const MPI::Datatype& sendtype, void* recvbuf, int recvcount,
17                                     const MPI::Datatype& recvtpe, int root) const = 0(binding
18                                     deprecated, see Section 15.2) }
19 ]

```

This call starts a nonblocking variant of MPI_SCATTER (see Section 5.6).

```

24 MPI_ISCATTERV(sendbuf, sendcounts, displs, sendtype, recvbuf, recvcount, recvtpe, root,
25               comm, request)

```

26			
27	IN	sendbuf	address of send buffer (choice, significant only at root)
28	IN	sendcounts	non-negative integer array (of length group size) specifying the number of elements to send to each [processor]rank
29			
30	IN	displs	integer array (of length group size). Entry <i>i</i> specifies the displacement (relative to <code>sendbuf</code>) from which to take the outgoing data to process <i>i</i>
31			
32			
33			
34	IN	sendtype	data type of send buffer elements (handle)
35	OUT	recvbuf	address of receive buffer (choice)
36	IN	recvcount	number of elements in receive buffer (non-negative integer)
37			
38			
39	IN	recvtpe	data type of receive buffer elements (handle)
40	IN	root	rank of sending process (integer)
41	IN	comm	communicator (handle)
42			
43	OUT	request	communication request (handle)
44			

```

45 int MPI_Iscluster(const void* sendbuf, const int sendcounts[], const
46                  int displs[], MPI_Datatype sendtype, void* recvbuf,
47                  int recvcount, MPI_Datatype recvtpe, int root, MPI_Comm comm,
48                  MPI_Request *request)

```

ticket229.1.
ticket-248T.

```

MPI_Iscatterv(sendbuf, sendcounts, displs, sendtype, recvbuf, recvcount,
              recvtype, root, comm, request, ierror) BIND(C)
    TYPE(*), DIMENSION(..), INTENT(IN), ASYNCHRONOUS :: sendbuf
    TYPE(*), DIMENSION(..), ASYNCHRONOUS :: recvbuf
    INTEGER, INTENT(IN), ASYNCHRONOUS :: sendcounts(*), displs(*)
    INTEGER, INTENT(IN) :: recvcount, root
    TYPE(MPI_Datatype), INTENT(IN) :: sendtype, recvtype
    TYPE(MPI_Comm), INTENT(IN) :: comm
    TYPE(MPI_Request), INTENT(OUT) :: request
    INTEGER, OPTIONAL, INTENT(OUT) :: ierror

```

```

MPI_ISCATTERV(SENDBUF, SENDCOUNTS, DISPLS, SENDTYPE, RECVBUF, RECVCOUNT,
              RECVTYPE, ROOT, COMM, REQUEST, IERROR)
    <type> SENDBUF(*), RECVBUF(*)
    INTEGER SENDCOUNTS(*), DISPLS(*), SENDTYPE, RECVCOUNT, RECVTYPE, ROOT,
    COMM, REQUEST, IERROR

```

```

[ {MPI::Request MPI::Comm::Iscatterv(const void* sendbuf,
    const int sendcounts[], const int displs[],
    const MPI::Datatype& sendtype, void* recvbuf, int recvcount,
    const MPI::Datatype& recvtype, int root) const = 0(binding
    deprecated, see Section 15.2) }

```

]

This call starts a nonblocking variant of MPI_SCATTERV (see Section 5.6).

5.12.5 Nonblocking Gather-to-all

```

MPI_IALLGATHER(sendbuf, sendcount, sendtype, recvbuf, recvcount, recvtype, comm,
               request)

```

IN	sendbuf	starting address of send buffer (choice)
IN	sendcount	number of elements in send buffer (non-negative integer)
IN	sendtype	data type of send buffer elements (handle)
OUT	recvbuf	address of receive buffer (choice)
IN	recvcount	number of elements received from any process (non-negative integer)
IN	recvtype	data type of receive buffer elements (handle)
IN	comm	communicator (handle)
OUT	request	communication request (handle)

```

int MPI_Iallgather(const void* sendbuf, int sendcount,
                  MPI_Datatype sendtype, void* recvbuf, int recvcount,
                  MPI_Datatype recvtype, MPI_Comm comm, MPI_Request *request)

```

ticket-248T.

```

1 MPI_Iallgather(sendbuf, sendcount, sendtype, recvbuf, recvcount, recvtype,
2               comm, request, ierror) BIND(C)
3
4     TYPE(*), DIMENSION(..), INTENT(IN), ASYNCHRONOUS :: sendbuf
5     TYPE(*), DIMENSION(..), ASYNCHRONOUS :: recvbuf
6     INTEGER, INTENT(IN) :: sendcount, recvcount
7     TYPE(MPI_Datatype), INTENT(IN) :: sendtype, recvtype
8     TYPE(MPI_Comm), INTENT(IN) :: comm
9     TYPE(MPI_Request), INTENT(OUT) :: request
10    INTEGER, OPTIONAL, INTENT(OUT) :: ierror

```

```

11 MPI_IALLGATHER(SENDBUF, SENDCOUNT, SENDTYPE, RECVBUF, RECVCOUNT, RECVTYPE,
12              COMM, REQUEST, IERROR)
13 <type> SENDBUF(*), RECVBUF(*)
14 INTEGER SENDCOUNT, SENDTYPE, RECVCOUNT, RECVTYPE, COMM, REQUEST, IERROR

```

ticket272.

```

15 [ {MPI::Request MPI::Comm::Iallgather(const void* sendbuf,
16   int sendcount, const MPI::Datatype& sendtype, void* recvbuf,
17   int recvcount, const MPI::Datatype& recvtype) const = 0(binding
18   deprecated, see Section 15.2) }

```

]

This call starts a nonblocking variant of MPI_ALLGATHER (see Section 5.7).

```

24 MPI_IALLGATHERV(sendbuf, sendcount, sendtype, recvbuf, recvcounts, displs, recvtype, comm,
25                request)

```

26	IN	sendbuf	starting address of send buffer (choice)
27			
28	IN	sendcount	number of elements in send buffer (non-negative integer)
29			
30	IN	sendtype	data type of send buffer elements (handle)
31	OUT	recvbuf	address of receive buffer (choice)
32			
33	IN	recvcounts	non-negative integer array (of length group size) containing the number of elements that are received from each process
34			
35			
36	IN	displs	integer array (of length group size). Entry <i>i</i> specifies the displacement (relative to <i>recvbuf</i>) at which to place the incoming data from process <i>i</i>
37			
38			
39	IN	recvtype	data type of receive buffer elements (handle)
40			
41	IN	comm	communicator (handle)
42	OUT	request	communication request (handle)
43			

```

44 int MPI_Iallgatherv(const void* sendbuf, int sendcount,
45                   MPI_Datatype sendtype, void* recvbuf, const int recvcounts[],
46                   const int displs[], MPI_Datatype recvtype, MPI_Comm comm,
47                   MPI_Request* request)

```

ticket140.

ticket140.

ticket140.

ticket229.1.

ticket-248T.

```

MPI_Iallgatherv(sendbuf, sendcount, sendtype, recvbuf, recvcoun
    recvtype, comm, request, ierror) BIND(C)
    TYPE(*), DIMENSION(..), INTENT(IN), ASYNCHRONOUS :: sendbuf
    TYPE(*), DIMENSION(..), ASYNCHRONOUS :: recvbuf
    INTEGER, INTENT(IN) :: sendcount
    INTEGER, INTENT(IN), ASYNCHRONOUS :: recvcoun(*), displs(*)
    TYPE(MPI_Datatype), INTENT(IN) :: sendtype, recvtype
    TYPE(MPI_Comm), INTENT(IN) :: comm
    TYPE(MPI_Request), INTENT(OUT) :: request
    INTEGER, OPTIONAL, INTENT(OUT) :: ierror

```

```

MPI_IALLGATHERV(SENDBUF, SENDCOUNT, SENDTYPE, RECVBUF, RECV
    RECVTYPE, COMM, REQUEST, IERROR)
    <type> SENDBUF(*), RECVBUF(*)
    INTEGER SENDCOUNT, SENDTYPE, RECVCOUNTS(*), DISPLS(*), RECVTYPE, COMM,
    REQUEST, IERROR

```

```

[ {MPI::Request MPI::Comm::Iallgatherv(const void* sendbuf,
    int sendcount, const MPI::Datatype& sendtype, void* recvbuf,
    const int recvcoun[], const int displs[],
    const MPI::Datatype& recvtype) const = 0(binding deprecated, see
    Section 15.2) }

```

```

]

```

This call starts a nonblocking variant of MPI_ALLGATHERV (see Section 5.7).

5.12.6 Nonblocking All-to-All Scatter/Gather

```

MPI_IALLTOALL(sendbuf, sendcount, sendtype, recvbuf, recvcoun

```

IN	sendbuf	starting address of send buffer (choice)
IN	sendcount	number of elements sent to each process (non-negative integer)
IN	sendtype	data type of send buffer elements (handle)
OUT	recvbuf	address of receive buffer (choice)
IN	recvcoun	number of elements received from any process (non-negative integer)
IN	recvtype	data type of receive buffer elements (handle)
IN	comm	communicator (handle)
OUT	request	communication request (handle)

```

int MPI_Ialltoall(const void* sendbuf, int sendcount,
    MPI_Datatype sendtype, void* recvbuf, int recvcoun
    MPI_Datatype recvtype, MPI_Comm comm, MPI_Request *request)

```

```

1 MPI_Ialltoall(sendbuf, sendcount, sendtype, recvbuf, recvcount, recvtype,
2             comm, request, ierror) BIND(C)
3     TYPE(*), DIMENSION(..), INTENT(IN), ASYNCHRONOUS :: sendbuf
4     TYPE(*), DIMENSION(..), ASYNCHRONOUS :: recvbuf
5     INTEGER, INTENT(IN) :: sendcount, recvcount
6     TYPE(MPI_Datatype), INTENT(IN) :: sendtype, recvtype
7     TYPE(MPI_Comm), INTENT(IN) :: comm
8     TYPE(MPI_Request), INTENT(OUT) :: request
9     INTEGER, OPTIONAL, INTENT(OUT) :: ierror

```

```

10 MPI_IALLTOALL(SENDBUF, SENDCOUNT, SENDTYPE, RECVBUF, REVCOUNT, RECVTYPE,
11             COMM, REQUEST, IERROR)
12     <type> SENDBUF(*), RECVBUF(*)
13     INTEGER SENDCOUNT, SENDTYPE, REVCOUNT, RECVTYPE, COMM, REQUEST, IERROR
14     [ {MPI::Request MPI::Comm::Ialltoall(const void* sendbuf, int sendcount,
15     const MPI::Datatype& sendtype, void* recvbuf, int recvcount,
16     const MPI::Datatype& recvtype) const = 0(binding deprecated, see
17     Section 15.2) }
18     ]

```

This call starts a nonblocking variant of MPI_ALLTOALL (see Section 5.8).

```

23 MPI_IALLTOALLV(sendbuf, sendcounts, sdispls, sendtype, recvbuf, recvcounts, rdispls,
24             recvtype, comm, request)

```

25			
26	IN	sendbuf	starting address of send buffer (choice)
27	IN	sendcounts	non-negative integer array (of length group size) specifying the number of elements to send to each [processor]rank
28			
29	IN	sdispls	integer array (of length group size). Entry j specifies the displacement (relative to sendbuf) from which to take the outgoing data destined for process j
30			
31			
32			
33	IN	sendtype	data type of send buffer elements (handle)
34	OUT	recvbuf	address of receive buffer (choice)
35	IN	recvcounts	non-negative integer array (of length group size) specifying the number of elements that can be received from each [processor]rank
36			
37			
38	IN	rdispls	integer array (of length group size). Entry i specifies the displacement (relative to recvbuf) at which to place the incoming data from process i
39			
40			
41			
42	IN	recvtype	data type of receive buffer elements (handle)
43	IN	comm	communicator (handle)
44	OUT	request	communication request (handle)
45			

```

47 int MPI_Ialltoallv(const void* sendbuf, const int sendcounts[], const
48                 int sdispls[], MPI_Datatype sendtype, void* recvbuf, const

```

```

    int recvcnts[], const int rdispls[], MPI_Datatype recvtype,
    MPI_Comm comm, MPI_Request *request)
MPI_Ialltoallv(sendbuf, sendcounts, sdispls, sendtype, recvbuf, recvcnts,
    rdispls, recvtype, comm, request, ierror) BIND(C)
TYPE(*), DIMENSION(..), INTENT(IN), ASYNCHRONOUS :: sendbuf
TYPE(*), DIMENSION(..), ASYNCHRONOUS :: recvbuf
INTEGER, INTENT(IN), ASYNCHRONOUS :: sendcounts(*), sdispls(*),
recvcnts(*), rdispls(*)
TYPE(MPI_Datatype), INTENT(IN) :: sendtype, recvtype
TYPE(MPI_Comm), INTENT(IN) :: comm
TYPE(MPI_Request), INTENT(OUT) :: request
INTEGER, OPTIONAL, INTENT(OUT) :: ierror
MPI_IALLTOALLV(SENDBUF, SENDCOUNTS, SDISPLS, SENDTYPE, RECVBUF, RECVCOUNTS,
    RDISPLS, RECVTYPE, COMM, REQUEST, IERROR)
<type> SENDBUF(*), RECVBUF(*)
INTEGER SENDCOUNTS(*), SDISPLS(*), SENDTYPE, RECVCOUNTS(*), RDISPLS(*),
RECVTYPE, COMM, REQUEST, IERROR
[ {MPI::Request MPI::Comm::Ialltoallv(const void* sendbuf,
    const int sendcounts[], const int sdispls[],
    const MPI::Datatype& sendtype, void* recvbuf,
    const int recvcnts[], const int rdispls[],
    const MPI::Datatype& recvtype) const = 0(binding deprecated, see
    Section 15.2) }
]

```

This call starts a nonblocking variant of `MPI_ALLTOALLV` (see Section 5.8).

```

1  MPI_IALLTOALLW(sendbuf, sendcounts, sdispls, sendtypes, recvbuf, recvcoun
2      recvtypes, comm, request)
3
4  IN      sendbuf      starting address of send buffer (choice)
5
6  IN      sendcounts   integer array (of length group size) specifying the num-
7      ber of elements to send to each [processor]rank (array
8      of non-negative integers)
9
10     IN      sdispls   integer array (of length group size). Entry j specifies
11     the displacement in bytes (relative to sendbuf) from
12     which to take the outgoing data destined for process
13     j (array of integers)
14
15     IN      sendtypes array of datatypes (of length group size). Entry j
16     specifies the type of data to send to process j (array
17     of handles)
18
19     OUT     recvbuf   address of receive buffer (choice)
20
21     IN      recvcoun
22     ts             integer array (of length group size) specifying the num-
23     ber of elements that can be received from each [processor]rank
24     (array of non-negative integers)
25
26     IN      rdispls   integer array (of length group size). Entry i specifies
27     the displacement in bytes (relative to recvbuf) at which
28     to place the incoming data from process i (array of
29     integers)
30
31     IN      recvtypes array of datatypes (of length group size). Entry i
32     specifies the type of data received from process i (ar-
33     ray of handles)
34
35     IN      comm      communicator (handle)
36
37     OUT     request   communication request (handle)

```

```

ticket140. 31
ticket140. 32 int MPI_Ialltoallw(const void* sendbuf, const int sendcounts[], const
ticket140. 33     int sdispls[], const MPI_Datatype sendtypes[], void* recvbuf,
ticket140. 34     const int recvcoun
ticket140. 35     ts[], const
ticket140. 36     MPI_Datatype recvtypes[], MPI_Comm comm, MPI_Request *request)
ticket140. 37 MPI_Ialltoallw(sendbuf, sendcounts, sdispls, sendtypes, recvbuf,
ticket140. 38     recvcoun
ticket140. 39     ts, rdispls, recvtypes, comm, request, ierror) BIND(C)
ticket229.1. 38 TYPE(*), DIMENSION(..), INTENT(IN), ASYNCHRONOUS :: sendbuf
ticket-248T. 39 TYPE(*), DIMENSION(..), ASYNCHRONOUS :: recvbuf
40 INTEGER, INTENT(IN), ASYNCHRONOUS :: sendcounts(*), sdispls(*),
41 recvcoun
42 ts(*), rdispls(*)
43 TYPE(MPI_Datatype), INTENT(IN), ASYNCHRONOUS :: sendtypes(*),
44 recvtypes(*)
45 TYPE(MPI_Comm), INTENT(IN) :: comm
46 TYPE(MPI_Request), INTENT(OUT) :: request
47 INTEGER, OPTIONAL, INTENT(OUT) :: ierror
48

```

```

MPI_IALLTOALLW(SENDBUF, SENDCOUNTS, SDISPLS, SENDTYPES, RECVBUFF,
               RECVCOUNTS, RDISPLS, RECVTYPES, COMM, REQUEST, IERROR)
<type> SENDBUF(*), RECVBUFF(*)
INTEGER SENDCOUNTS(*), SDISPLS(*), SENDTYPES(*), RECVCOUNTS(*),
RDISPLS(*), RECVTYPES(*), COMM, REQUEST, IERROR
[ {MPI::Request MPI::Comm::Ialltoallw(const void* sendbuf, const int
    sendcounts[], const int sdispls[], const MPI::Datatype
    sendtypes[], void* recvbuf, const int recvcounts[], const int
    rdispls[], const MPI::Datatype recvtypes[]) const = 0(binding
    deprecated, see Section 15.2) }
]

```

ticket272.

This call starts a nonblocking variant of MPI_ALLTOALLW (see Section 5.8).

5.12.7 Nonblocking Reduce

```

MPI_IREDUCE(sendbuf, recvbuf, count, datatype, op, root, comm, request)
IN          sendbuf          address of send buffer (choice)
OUT         recvbuf          address of receive buffer (choice, significant only at
                                root)
IN          count            number of elements in send buffer (non-negative inte-
                                ger)
IN          datatype         data type of elements of send buffer (handle)
IN          op                reduce operation (handle)
IN          root              rank of root process (integer)
IN          comm              communicator (handle)
OUT         request          communication request (handle)

```

```

int MPI_Ireduce(const void* sendbuf, void* recvbuf, int count,
               MPI_Datatype datatype, MPI_Op op, int root, MPI_Comm comm,
               MPI_Request *request)

```

ticket140.

```

MPI_Ireduce(sendbuf, recvbuf, count, datatype, op, root, comm, request,
            ierror) BIND(C)
TYPE(*), DIMENSION(..), INTENT(IN), ASYNCHRONOUS :: sendbuf
TYPE(*), DIMENSION(..), ASYNCHRONOUS :: recvbuf
INTEGER, INTENT(IN) :: count, root
TYPE(MPI_Datatype), INTENT(IN) :: datatype
TYPE(MPI_Op), INTENT(IN) :: op
TYPE(MPI_Comm), INTENT(IN) :: comm
TYPE(MPI_Request), INTENT(OUT) :: request
INTEGER, OPTIONAL, INTENT(OUT) :: ierror

```

ticket-248T.

```

MPI_IREDUCE(SENDBUF, RECVBUFF, COUNT, DATATYPE, OP, ROOT, COMM, REQUEST,
            IERROR)

```

```

1      <type> SENDBUF(*), RECVBUF(*)
2      INTEGER COUNT, DATATYPE, OP, ROOT, COMM, REQUEST, IERROR
3
4      [ {MPI::Request MPI::Comm::Ireduce(const void* sendbuf, void* recvbuf,
5          int count, const MPI::Datatype& datatype, const MPI::Op& op,
6          int root) const = 0(binding deprecated, see Section 15.2) }
7
8      ]

```

This call starts a nonblocking variant of MPI_REDUCE (see Section 5.9.1).

Advice to implementors. The implementation is explicitly allowed to use different algorithms for blocking and nonblocking reduction operations that might change the order of evaluation of the operations. However, as for MPI_REDUCE, it is strongly recommended that MPI_IREDUCE be implemented so that the same result be obtained whenever the function is applied on the same arguments, appearing in the same order. Note that this may prevent optimizations that take advantage of the physical location of processes. (*End of advice to implementors.*)

Advice to users. For operations which are not truly associative, the result delivered upon completion of the nonblocking reduction may not exactly equal the result delivered by the blocking reduction, even when specifying the same arguments in the same order. (*End of advice to users.*)

5.12.8 Nonblocking All-Reduce

```

26 MPI_IALLREDUCE(sendbuf, recvbuf, count, datatype, op, comm, request)

```

27	IN	sendbuf	starting address of send buffer (choice)
28	OUT	recvbuf	starting address of receive buffer (choice)
29			
30	IN	count	number of elements in send buffer (non-negative integer)
31			
32	IN	datatype	data type of elements of send buffer (handle)
33			
34	IN	op	operation (handle)
35	IN	comm	communicator (handle)
36	OUT	request	communication request (handle)
37			

```

38
39 int MPI_Iallreduce(const void* sendbuf, void* recvbuf, int count,
40     MPI_Datatype datatype, MPI_Op op, MPI_Comm comm,
41     MPI_Request *request)

```

```

42 MPI_Iallreduce(sendbuf, recvbuf, count, datatype, op, comm, request,
43     ierror) BIND(C)
44     TYPE(*), DIMENSION(..), INTENT(IN), ASYNCHRONOUS :: sendbuf
45     TYPE(*), DIMENSION(..), ASYNCHRONOUS :: recvbuf
46     INTEGER, INTENT(IN) :: count
47     TYPE(MPI_Datatype), INTENT(IN) :: datatype
48     TYPE(MPI_Op), INTENT(IN) :: op

```



```

TYPE(MPI_Comm), INTENT(IN) :: comm
TYPE(MPI_Request), INTENT(OUT) :: request
INTEGER, OPTIONAL, INTENT(OUT) :: ierror

MPI_IALLREDUCE(SENDBUF, RECVBUF, COUNT, DATATYPE, OP, COMM, REQUEST,
              IERROR)
<type> SENDBUF(*), RECVBUF(*)
INTEGER COUNT, DATATYPE, OP, COMM, REQUEST, IERROR

[ {MPI::Request MPI::Comm::Iallreduce(const void* sendbuf,
    void* recvbuf, int count, const MPI::Datatype& datatype,
    const MPI::Op& op) const = 0(binding deprecated, see Section 15.2) }
]

```

This call starts a nonblocking variant of MPI_ALLREDUCE (see Section 5.9.6).

ticket272.

5.12.9 Nonblocking Reduce-Scatter with Equal Blocks

```
MPI_IREDUCE_SCATTER_BLOCK(sendbuf, recvbuf, recvcount, datatype, op, comm, request)
```

IN	sendbuf	starting address of send buffer (choice)
OUT	recvbuf	starting address of receive buffer (choice)
IN	recvcount	element count per block (non-negative integer)
IN	datatype	data type of elements of send and receive buffers (handle)
IN	op	operation (handle)
IN	comm	communicator (handle)
OUT	request	communication request (handle)

```

int MPI_Ireduce_scatter_block(const void* sendbuf, void* recvbuf,
    int recvcount, MPI_Datatype datatype, MPI_Op op,
    MPI_Comm comm, MPI_Request *request)

```

```

MPI_Ireduce_scatter_block(sendbuf, recvbuf, recvcount, datatype, op, comm,
    request, ierror) BIND(C)
TYPE(*), DIMENSION(..), INTENT(IN), ASYNCHRONOUS :: sendbuf
TYPE(*), DIMENSION(..), ASYNCHRONOUS :: recvbuf
INTEGER, INTENT(IN) :: recvcount
TYPE(MPI_Datatype), INTENT(IN) :: datatype
TYPE(MPI_Op), INTENT(IN) :: op
TYPE(MPI_Comm), INTENT(IN) :: comm
TYPE(MPI_Request), INTENT(OUT) :: request
INTEGER, OPTIONAL, INTENT(OUT) :: ierror

MPI_IREDUCE_SCATTER_BLOCK(SENDBUF, RECVBUF, RECVCOUNT, DATATYPE, OP, COMM,
    REQUEST, IERROR)

```

ticket140.

ticket-248T.

```

1      <type> SENDBUF(*), RECVBUF(*)
2      INTEGER RECVCOUNT, DATATYPE, OP, COMM, REQUEST, IERROR
3
4      [ {MPI::Request MPI::Comm::Ireduce_scatter_block(const void* sendbuf,
5              void* recvbuf, int recvcount, const MPI::Datatype& datatype,
6              const MPI::Op& op) const = 0(binding deprecated, see Section 15.2) }
7
8      ]

```

This call starts a nonblocking variant of MPI_REDUCE_SCATTER_BLOCK (see Section 5.10.1).

5.12.10 Nonblocking Reduce-Scatter

```

14 MPI_IREDUCE_SCATTER(sendbuf, recvbuf, recvcounts, datatype, op, comm, request)

```

16	IN	sendbuf	starting address of send buffer (choice)
17	OUT	recvbuf	starting address of receive buffer (choice)
18	IN	recvcounts	non-negative integer array specifying the number of elements in result distributed to each process. Array must be identical on all calling processes.
22	IN	datatype	data type of elements of input buffer (handle)
23	IN	op	operation (handle)
24	IN	comm	communicator (handle)
26	OUT	request	communication request (handle)

```

28 int MPI_Ireduce_scatter(const void* sendbuf, void* recvbuf, const
29     int recvcounts[], MPI_Datatype datatype, MPI_Op op,
30     MPI_Comm comm, MPI_Request *request)

```

```

31 MPI_Ireduce_scatter(sendbuf, recvbuf, recvcounts, datatype, op, comm,
32     request, ierror) BIND(C)
33     TYPE(*), DIMENSION(..), INTENT(IN), ASYNCHRONOUS :: sendbuf
34     TYPE(*), DIMENSION(..), ASYNCHRONOUS :: recvbuf
35     INTEGER, INTENT(IN), ASYNCHRONOUS :: recvcounts(*)
36     TYPE(MPI_Datatype), INTENT(IN) :: datatype
37     TYPE(MPI_Op), INTENT(IN) :: op
38     TYPE(MPI_Comm), INTENT(IN) :: comm
39     TYPE(MPI_Request), INTENT(OUT) :: request
40     INTEGER, OPTIONAL, INTENT(OUT) :: ierror

```

```

42 MPI_IREDUCE_SCATTER(SENDBUF, RECVBUF, RECVCOUNTS, DATATYPE, OP, COMM,
43     REQUEST, IERROR)
44     <type> SENDBUF(*), RECVBUF(*)
45     INTEGER RECVCOUNTS(*), DATATYPE, OP, COMM, REQUEST, IERROR

```

```

46     [ {MPI::Request MPI::Comm::Ireduce_scatter(const void* sendbuf,
47         void* recvbuf, int recvcounts[],
48

```

```

        const MPI::Datatype& datatype, const MPI::Op& op)
        const = 0(binding deprecated, see Section 15.2) }
    ]

```

This call starts a nonblocking variant of MPI_REDUCE_SCATTER (see Section 5.10.2).

5.12.11 Nonblocking Inclusive Scan

MPI_ISCAN(sendbuf, recvbuf, count, datatype, op, comm, request)

IN	sendbuf	starting address of send buffer (choice)
OUT	recvbuf	starting address of receive buffer (choice)
IN	count	number of elements in input buffer (non-negative integer)
IN	datatype	data type of elements of input buffer (handle)
IN	op	operation (handle)
IN	comm	communicator (handle)
OUT	request	communication request (handle)

```

int MPI_Iscan(const void* sendbuf, void* recvbuf, int count,
             MPI_Datatype datatype, MPI_Op op, MPI_Comm comm,
             MPI_Request *request)

```

ticket140.

```

MPI_Iscan(sendbuf, recvbuf, count, datatype, op, comm, request, ierror)
        BIND(C)
        TYPE(*), DIMENSION(..), INTENT(IN), ASYNCHRONOUS :: sendbuf
        TYPE(*), DIMENSION(..), ASYNCHRONOUS :: recvbuf
        INTEGER, INTENT(IN) :: count
        TYPE(MPI_Datatype), INTENT(IN) :: datatype
        TYPE(MPI_Op), INTENT(IN) :: op
        TYPE(MPI_Comm), INTENT(IN) :: comm
        TYPE(MPI_Request), INTENT(OUT) :: request
        INTEGER, OPTIONAL, INTENT(OUT) :: ierror

```

ticket-248T.

```

MPI_ISCAN(SENDBUF, RECVBUF, COUNT, DATATYPE, OP, COMM, REQUEST, IERROR)
    <type> SENDBUF(*), RECVBUF(*)
    INTEGER COUNT, DATATYPE, OP, COMM, REQUEST, IERROR

```

```

    [ {MPI::Request MPI::Intracomm::Iscale(const void* sendbuf,
        void* recvbuf, int count, const MPI::Datatype& datatype,
        const MPI::Op& op) const(binding deprecated, see Section 15.2) }
    ]

```

ticket272.

This call starts a nonblocking variant of MPI_SCAN (see Section 5.11).

5.12.12 Nonblocking Exclusive Scan

`MPI_IEXSCAN(sendbuf, recvbuf, count, datatype, op, comm, request)`

IN	sendbuf	starting address of send buffer (choice)
OUT	recvbuf	starting address of receive buffer (choice)
IN	count	number of elements in input buffer (non-negative integer)
IN	datatype	data type of elements of input buffer (handle)
IN	op	operation (handle)
IN	comm	intracommunicator (handle)
OUT	request	communication request (handle)

```
int MPI_Iexscan(const void* sendbuf, void* recvbuf, int count,
               MPI_Datatype datatype, MPI_Op op, MPI_Comm comm,
               MPI_Request *request)
```

```
MPI_Iexscan(sendbuf, recvbuf, count, datatype, op, comm, request, ierror)
           BIND(C)
```

```
TYPE(*), DIMENSION(..), INTENT(IN), ASYNCHRONOUS :: sendbuf
TYPE(*), DIMENSION(..), ASYNCHRONOUS :: recvbuf
INTEGER, INTENT(IN) :: count
TYPE(MPI_Datatype), INTENT(IN) :: datatype
TYPE(MPI_Op), INTENT(IN) :: op
TYPE(MPI_Comm), INTENT(IN) :: comm
TYPE(MPI_Request), INTENT(OUT) :: request
INTEGER, OPTIONAL, INTENT(OUT) :: ierror
```

```
MPI_IEXSCAN(SENDBUF, RECVBUF, COUNT, DATATYPE, OP, COMM, REQUEST, IERROR)
<type> SENDBUF(*), RECVBUF(*)
INTEGER COUNT, DATATYPE, OP, COMM, REQUEST, IERROR
```

```
[ {MPI::Request MPI::Intracomm::Iexscan(const void* sendbuf, void*
    recvbuf, int count, const MPI::Datatype& datatype, const
    MPI::Op& op) const(binding deprecated, see Section 15.2) }
```

```
]
This call starts a nonblocking variant of MPI_EXSCAN (see Section 5.11.2).
```

5.13 Correctness

A correct, portable program must invoke collective communications so that deadlock will not occur, whether collective communications are synchronizing or not. The following examples illustrate dangerous use of collective routines on intracommunicators.

Example 5.25

The following is erroneous.

```

switch(rank) {
  case 0:
    MPI_Bcast(buf1, count, type, 0, comm);
    MPI_Bcast(buf2, count, type, 1, comm);
    break;
  case 1:
    MPI_Bcast(buf2, count, type, 1, comm);
    MPI_Bcast(buf1, count, type, 0, comm);
    break;
}

```

We assume that the group of `comm` is $\{0,1\}$. Two processes execute two broadcast operations in reverse order. If the operation is synchronizing then a deadlock will occur.

Collective operations must be executed in the same order at all members of the communication group.

Example 5.26

The following is erroneous.

```

switch(rank) {
  case 0:
    MPI_Bcast(buf1, count, type, 0, comm0);
    MPI_Bcast(buf2, count, type, 2, comm2);
    break;
  case 1:
    MPI_Bcast(buf1, count, type, 1, comm1);
    MPI_Bcast(buf2, count, type, 0, comm0);
    break;
  case 2:
    MPI_Bcast(buf1, count, type, 2, comm2);
    MPI_Bcast(buf2, count, type, 1, comm1);
    break;
}

```

Assume that the group of `comm0` is $\{0,1\}$, of `comm1` is $\{1, 2\}$ and of `comm2` is $\{2,0\}$. If the broadcast is a synchronizing operation, then there is a cyclic dependency: the broadcast in `comm2` completes only after the broadcast in `comm0`; the broadcast in `comm0` completes only after the broadcast in `comm1`; and the broadcast in `comm1` completes only after the broadcast in `comm2`. Thus, the code will deadlock.

Collective operations must be executed in an order so that no cyclic dependencies occur. Nonblocking collective operations can alleviate this issue.

Example 5.27

The following is erroneous.

```

1  switch(rank) {
2      case 0:
3          MPI_Bcast(buf1, count, type, 0, comm);
4          MPI_Send(buf2, count, type, 1, tag, comm);
5          break;
6      case 1:
7          MPI_Recv(buf2, count, type, 0, tag, comm, status);
8          MPI_Bcast(buf1, count, type, 0, comm);
9          break;
10 }

```

12 Process zero executes a broadcast, followed by a blocking send operation. Process one
13 first executes a blocking receive that matches the send, followed by broadcast call that
14 matches the broadcast of process zero. This program may deadlock. The broadcast call on
15 process zero *may* block until process one executes the matching broadcast call, so that the
16 send is not executed. Process one will definitely block on the receive and so, in this case,
17 never executes the broadcast.

18 The relative order of execution of collective operations and point-to-point operations
19 should be such, so that even if the collective operations and the point-to-point operations
20 are synchronizing, no deadlock will occur.

21 **Example 5.28**

22 An unsafe, non-deterministic program.

```

23
24 switch(rank) {
25     case 0:
26         MPI_Bcast(buf1, count, type, 0, comm);
27         MPI_Send(buf2, count, type, 1, tag, comm);
28         break;
29     case 1:
30         MPI_Recv(buf2, count, type, MPI_ANY_SOURCE, tag, comm, status);
31         MPI_Bcast(buf1, count, type, 0, comm);
32         MPI_Recv(buf2, count, type, MPI_ANY_SOURCE, tag, comm, status);
33         break;
34     case 2:
35         MPI_Send(buf2, count, type, 1, tag, comm);
36         MPI_Bcast(buf1, count, type, 0, comm);
37         break;
38 }
39

```

40 All three processes participate in a broadcast. Process 0 sends a message to process
41 1 after the broadcast, and process 2 sends a message to process 1 before the broadcast.
42 Process 1 receives before and after the broadcast, with a wildcard source argument.

43 Two possible executions of this program, with different matchings of sends and receives,
44 are illustrated in Figure 5.12. Note that the second execution has the peculiar effect that
45 a send executed after the broadcast is received at another node before the broadcast. This
46 example illustrates the fact that one should not rely on collective communication functions
47 to have particular synchronization effects. A program that works correctly only when the
48 first execution occurs (only when broadcast is synchronizing) is erroneous.

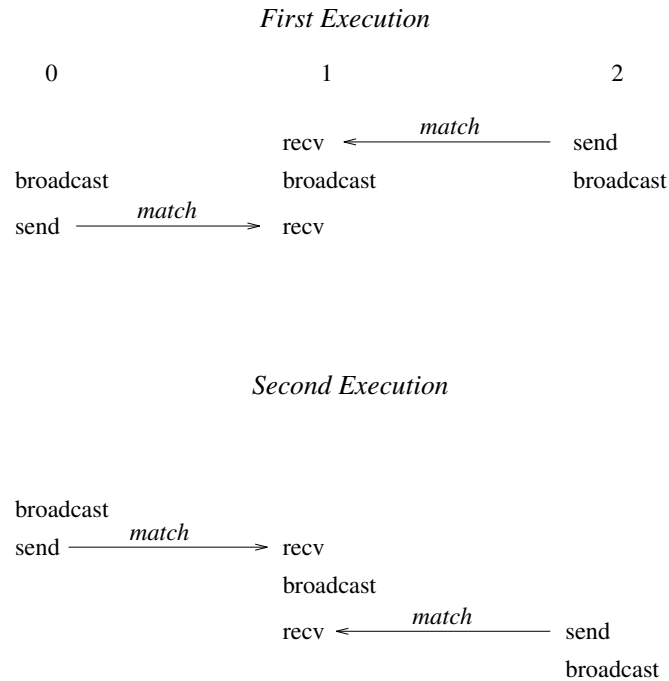

Figure 5.12: A race condition causes non-deterministic matching of sends and receives. One cannot rely on synchronization from a broadcast to make the program deterministic.

Finally, in multithreaded implementations, one can have more than one, concurrently executing, collective communication call at a process. In these situations, it is the user’s responsibility to ensure that the same communicator is not used concurrently by two different collective communication calls at the same process.

Advice to implementors. Assume that broadcast is implemented using point-to-point MPI communication. Suppose the following two rules are followed.

1. All receives specify their source explicitly (no wildcards).
2. Each process sends all messages that pertain to one collective call before sending any message that pertain to a subsequent collective call.

Then, messages belonging to successive broadcasts cannot be confused, as the order of point-to-point messages is preserved.

It is the implementor’s responsibility to ensure that point-to-point messages are not confused with collective messages. One way to accomplish this is, whenever a communicator is created, to also create a “hidden communicator” for collective communication. One could achieve a similar effect more cheaply, for example, by using a hidden tag or context bit to indicate whether the communicator is used for point-to-point or collective communication. (*End of advice to implementors.*)

Example 5.29

Blocking and nonblocking collective operations can be interleaved, i.e., a blocking collective operation can be posted even if there is a nonblocking collective operation outstanding.

```

1 MPI_Request req;
2
3 MPI_Ibarrier(comm, &req);
4 MPI_Bcast(buf1, count, type, 0, comm);
5 MPI_Wait(&req, MPI_STATUS_IGNORE);
6

```

Each process starts a nonblocking barrier operation, participates in a blocking broadcast and then waits until every other process started the barrier operation. This effectively turns the broadcast into a synchronizing broadcast with possible communication/communication overlap (MPI_Bcast is allowed, but not required to synchronize).

Example 5.30

The starting order of collective operations on a particular communicator defines their matching. The following example shows an erroneous matching of different collective operations on the same communicator.

```

16 MPI_Request req;
17 switch(rank) {
18     case 0:
19         /* erroneous matching */
20         MPI_Ibarrier(comm, &req);
21         MPI_Bcast(buf1, count, type, 0, comm);
22         MPI_Wait(&req, MPI_STATUS_IGNORE);
23         break;
24     case 1:
25         /* erroneous matching */
26         MPI_Bcast(buf1, count, type, 0, comm);
27         MPI_Ibarrier(comm, &req);
28         MPI_Wait(&req, MPI_STATUS_IGNORE);
29         break;
30 }
31

```

This ordering would match MPI_Ibarrier on rank 0 with MPI_Bcast on rank 1 which is erroneous and the program behavior is undefined. However, if such an order is required, the user must create different duplicate communicators and perform the operations on them. If started with two processes, the following program would be correct:

```

37 MPI_Request req;
38 MPI_Comm dupcomm;
39 MPI_Comm_dup(comm, &dupcomm);
40 switch(rank) {
41     case 0:
42         MPI_Ibarrier(comm, &req);
43         MPI_Bcast(buf1, count, type, 0, dupcomm);
44         MPI_Wait(&req, MPI_STATUS_IGNORE);
45         break;
46     case 1:
47         MPI_Bcast(buf1, count, type, 0, dupcomm);
48         MPI_Ibarrier(comm, &req);

```



```

    MPI_Wait(&req, MPI_STATUS_IGNORE);
    break;
}

```

Advice to users. The use of different communicators offers some flexibility regarding the matching of nonblocking collective operations. In this sense, communicators could be used as an equivalent to tags. However, communicator construction might induce overheads so that this should be used carefully. (*End of advice to users.*)

Example 5.31

Nonblocking collective operations can rely on the same progression rules as nonblocking point-to-point messages. Thus, if started with two processes, the following program is a valid MPI program and is guaranteed to terminate:

```

MPI_Request req;

switch(rank) {
  case 0:
    MPI_Ibarrier(comm, &req);
    MPI_Wait(&req, MPI_STATUS_IGNORE);
    MPI_Send(buf, count, dtype, 1, tag, comm);
    break;
  case 1:
    MPI_Ibarrier(comm, &req);
    MPI_Recv(buf, count, dtype, 0, tag, comm, MPI_STATUS_IGNORE);
    MPI_Wait(&req, MPI_STATUS_IGNORE);
    break;
}

```

The MPI library must progress the barrier in the MPI_Recv call. Thus, the MPI_Wait call in rank 0 will eventually complete, which enables the matching MPI_Send so all calls eventually return.

Example 5.32

Blocking and nonblocking collective operations do not match. The following example is erroneous.

```

MPI_Request req;

switch(rank) {
  case 0:
    /* erroneous false matching of Alltoall and Ialltoall */
    MPI_Ialltoall(sbuf, scnt, stype, rbuf, rcnt, rtype, comm, &req);
    MPI_Wait(&req, MPI_STATUS_IGNORE);
    break;
  case 1:
    /* erroneous false matching of Alltoall and Ialltoall */
    MPI_Alltoall(sbuf, scnt, stype, rbuf, rcnt, rtype, comm);
    break;
}

```

Example 5.33

Collective and point-to-point requests can be mixed in functions that enable multiple completions. If started with two processes, the following program is valid.

```

1 MPI_Request reqs[2];
2
3
4
5 MPI_Request reqs[2];
6
7 switch(rank) {
8     case 0:
9         MPI_Ibarrier(comm, &reqs[0]);
10        MPI_Send(buf, count, dtype, 1, tag, comm);
11        MPI_Wait(&reqs[0], MPI_STATUS_IGNORE);
12        break;
13    case 1:
14        MPI_Irecv(buf, count, dtype, 0, tag, comm, &reqs[0]);
15        MPI_Ibarrier(comm, &reqs[1]);
16        MPI_Waitall(2, reqs, MPI_STATUSES_IGNORE);
17        break;
18 }

```

The Waitall call returns only after the barrier and the receive completed.

Example 5.34

Multiple nonblocking collective operations can be outstanding on a single communicator and match in order.

```

25 MPI_Request reqs[3];
26
27 compute(buf1);
28 MPI_Ibcast(buf1, count, type, 0, comm, &reqs[0]);
29 compute(buf2);
30 MPI_Ibcast(buf2, count, type, 0, comm, &reqs[1]);
31 compute(buf3);
32 MPI_Ibcast(buf3, count, type, 0, comm, &reqs[2]);
33 MPI_Waitall(3, reqs, MPI_STATUSES_IGNORE);
34

```

Advice to users. Pipelining and double-buffering techniques can efficiently be used to overlap computation and communication. However, having too many outstanding requests might have a negative impact on performance. (*End of advice to users.*)

Advice to implementors. The use of pipelining may generate many outstanding requests. A high-quality hardware-supported implementation with limited resources should be able to fall back to a software implementation if its resources are exhausted. In this way, the implementation could limit the number of outstanding requests only by the available memory. (*End of advice to implementors.*)

Example 5.35

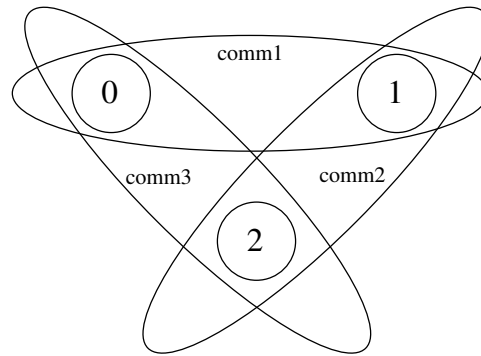

Figure 5.13: Example with overlapping communicators.

Nonblocking collective operations can also be used to enable simultaneous collective operations on multiple overlapping communicators (see Figure 5.13). The following example is started with three processes and three communicators. The first communicator `comm1` includes ranks 0 and 1, `comm2` includes ranks 1 and 2 and `comm3` spans ranks 0 and 2. It is not possible to perform a blocking collective operation on all communicators because there exists no deadlock-free order to invoke them. However, nonblocking collective operations can easily be used to achieve this task.

```
MPI_Request reqs[2];

switch(rank) {
  case 0:
    MPI_Iallreduce(sbuf1, rbuf1, count, dtype, MPI_SUM, comm1, &reqs[0]);
    MPI_Iallreduce(sbuf3, rbuf3, count, dtype, MPI_SUM, comm3, &reqs[1]);
    break;
  case 1:
    MPI_Iallreduce(sbuf1, rbuf1, count, dtype, MPI_SUM, comm1, &reqs[0]);
    MPI_Iallreduce(sbuf2, rbuf2, count, dtype, MPI_SUM, comm2, &reqs[1]);
    break;
  case 2:
    MPI_Iallreduce(sbuf2, rbuf2, count, dtype, MPI_SUM, comm2, &reqs[0]);
    MPI_Iallreduce(sbuf3, rbuf3, count, dtype, MPI_SUM, comm3, &reqs[1]);
    break;
}
MPI_Waitall(2, reqs, MPI_STATUSES_IGNORE);
```

Advice to users. This method can be useful if overlapping neighboring regions (halo or ghost zones) are used in collective operations. The sequence of the two calls in each process is irrelevant because the two nonblocking operations are performed on different communicators. (*End of advice to users.*)

Example 5.36

The progress of multiple outstanding nonblocking collective operations is completely independent.

```
1 MPI_Request reqs[2];
2
3 compute(buf1);
4 MPI_Ibcast(buf1, count, type, 0, comm, &reqs[0]);
5 compute(buf2);
6 MPI_Ibcast(buf2, count, type, 0, comm, &reqs[1]);
7 MPI_Wait(&reqs[1], MPI_STATUS_IGNORE);
8 /* nothing is known about the status of the first bcast here */
9 MPI_Wait(&reqs[0], MPI_STATUS_IGNORE);
10
```

11 Finishing the second MPI_IBCAST is completely independent of the first one. This
12 means that it is not guaranteed that the first broadcast operation is finished or even started
13 after the second one is completed via reqs[1].

14

15

16

17

18

19

20

21

22

23

24

25

26

27

28

29

30

31

32

33

34

35

36

37

38

39

40

41

42

43

44

45

46

47

48

1
2
3
4
5
6
7
8
9
10
11
12
13
14
15
16
17
18
19
20
21
22
23
24
25
26
27
28
29
30
31
32
33
34
35
36
37
38
39
40
41
42
43
44
45
46
47
48

Chapter 6

Groups, Contexts, Communicators, and Caching

6.1 Introduction

This chapter introduces MPI features that support the development of parallel libraries. Parallel libraries are needed to encapsulate the distracting complications inherent in parallel implementations of key algorithms. They help to ensure consistent correctness of such procedures, and provide a “higher level” of portability than MPI itself can provide. As such, libraries prevent each programmer from repeating the work of defining consistent data structures, data layouts, and methods that implement key algorithms (such as matrix operations). Since the best libraries come with several variations on parallel systems (different data layouts, different strategies depending on the size of the system or problem, or type of floating point), this too needs to be hidden from the user.

We refer the reader to [55] and [3] for further information on writing libraries in MPI, using the features described in this chapter.

6.1.1 Features Needed to Support Libraries

The key features needed to support the creation of robust parallel libraries are as follows:

- Safe communication space, that guarantees that libraries can communicate as they need to, without conflicting with communication extraneous to the library,
- Group scope for collective operations, that allow libraries to avoid unnecessarily synchronizing uninvolved processes (potentially running unrelated code),
- Abstract process naming to allow libraries to describe their communication in terms suitable to their own data structures and algorithms,
- The ability to “adorn” a set of communicating processes with additional user-defined attributes, such as extra collective operations. This mechanism should provide a means for the user or library writer effectively to extend a message-passing notation.

In addition, a unified mechanism or object is needed for conveniently denoting communication context, the group of communicating processes, to house abstract process naming, and to store adornments.

6.1.2 MPI's Support for Libraries

The corresponding concepts that MPI provides, specifically to support robust libraries, are as follows:

- **Contexts** of communication,
- **Groups** of processes,
- **Virtual topologies**,
- **Attribute caching**,
- **Communicators**.

Communicators (see [20, 53, 58]) encapsulate all of these ideas in order to provide the appropriate scope for all communication operations in MPI. Communicators are divided into two kinds: intra-communicators for operations within a single group of processes and inter-communicators for operations between two groups of processes.

Caching. Communicators (see below) provide a “caching” mechanism that allows one to associate new attributes with communicators, on a par with MPI built-in features. This can be used by advanced users to adorn communicators further, and by MPI to implement some communicator functions. For example, the virtual-topology functions described in Chapter 7 are likely to be supported this way.

Groups. Groups define an ordered collection of processes, each with a rank, and it is this group that defines the low-level names for inter-process communication (ranks are used for sending and receiving). Thus, groups define a scope for process names in point-to-point communication. In addition, groups define the scope of collective operations. Groups may be manipulated separately from communicators in MPI, but only communicators can be used in communication operations.

Intra-communicators. The most commonly used means for message passing in MPI is via intra-communicators. Intra-communicators contain an instance of a group, contexts of communication for both point-to-point and collective communication, and the ability to include virtual topology and other attributes. These features work as follows:

- **Contexts** provide the ability to have separate safe “universes” of message-passing in MPI. A context is akin to an additional tag that differentiates messages. The system manages this differentiation process. The use of separate communication contexts by distinct libraries (or distinct library invocations) insulates communication internal to the library execution from external communication. This allows the invocation of the library even if there are pending communications on “other” communicators, and avoids the need to synchronize entry or exit into library code. Pending point-to-point communications are also guaranteed not to interfere with collective communications within a single communicator.
- **Groups** define the participants in the communication (see above) of a communicator.

- A **virtual topology** defines a special mapping of the ranks in a group to and from a topology. Special constructors for communicators are defined in Chapter 7 to provide this feature. Intra-communicators as described in this chapter do not have topologies.
- **Attributes** define the local information that the user or library has added to a communicator for later reference.

Advice to users. The practice in many communication libraries is that there is a unique, predefined communication universe that includes all processes available when the parallel program is initiated; the processes are assigned consecutive ranks. Participants in a point-to-point communication are identified by their rank; a collective communication (such as broadcast) always involves all processes. This practice can be followed in MPI by using the predefined communicator `MPI_COMM_WORLD`. *Users who are satisfied with this practice can plug in `MPI_COMM_WORLD` wherever a communicator argument is required, and can consequently disregard the rest of this chapter. (End of advice to users.)*

Inter-communicators. The discussion has dealt so far with **intra-communication**: communication within a group. MPI also supports **inter-communication**: communication between two non-overlapping groups. When an application is built by composing several parallel modules, it is convenient to allow one module to communicate with another using local ranks for addressing within the second module. This is especially convenient in a client-server computing paradigm, where either client or server are parallel. The support of inter-communication also provides a mechanism for the extension of MPI to a dynamic model where not all processes are preallocated at initialization time. In such a situation, it becomes necessary to support communication across “universes.” Inter-communication is supported by objects called **inter-communicators**. These objects bind two groups together with communication contexts shared by both groups. For inter-communicators, these features work as follows:

- **Contexts** provide the ability to have a separate safe “universe” of message-passing between the two groups. A send in the local group is always a receive in the remote group, and vice versa. The system manages this differentiation process. The use of separate communication contexts by distinct libraries (or distinct library invocations) insulates communication internal to the library execution from external communication. This allows the invocation of the library even if there are pending communications on “other” communicators, and avoids the need to synchronize entry or exit into library code.
- A local and remote group specify the recipients and destinations for an inter-communicator.
- Virtual topology is undefined for an inter-communicator.
- As before, attributes cache defines the local information that the user or library has added to a communicator for later reference.

MPI provides mechanisms for creating and manipulating inter-communicators. They are used for point-to-point and collective communication in an related manner to intra-communicators. Users who do not need inter-communication in their applications can safely

1 ignore this extension. Users who require inter-communication between overlapping groups
 2 must layer this capability on top of MPI.
 3

4 6.2 Basic Concepts 5

6 In this section, we turn to a more formal definition of the concepts introduced above.
 7

8 6.2.1 Groups 9

10 A **group** is an ordered set of process identifiers (henceforth processes); processes are
 11 implementation-dependent objects. Each process in a group is associated with an inte-
 12 ger **rank**. Ranks are contiguous and start from zero. Groups are represented by opaque
 13 **group objects**, and hence cannot be directly transferred from one process to another. A
 14 group is used within a communicator to describe the participants in a communication “uni-
 15 verse” and to rank such participants (thus giving them unique names within that “universe”
 16 of communication).

17 There is a special pre-defined group: `MPI_GROUP_EMPTY`, which is a group with no
 18 members. The predefined constant `MPI_GROUP_NULL` is the value used for invalid group
 19 handles.
 20

21 *Advice to users.* `MPI_GROUP_EMPTY`, which is a valid handle to an empty group,
 22 should not be confused with `MPI_GROUP_NULL`, which in turn is an invalid handle.
 23 The former may be used as an argument to group operations; the latter, which is
 24 returned when a group is freed, is not a valid argument. (*End of advice to users.*)
 25

26 *Advice to implementors.* A group may be represented by a virtual-to-real process-
 27 address-translation table. Each communicator object (see below) would have a pointer
 28 to such a table.

29 Simple implementations of MPI will enumerate groups, such as in a table. However,
 30 more advanced data structures make sense in order to improve scalability and memory
 31 usage with large numbers of processes. Such implementations are possible with MPI.
 32 (*End of advice to implementors.*)
 33

34 6.2.2 Contexts 35

36 A **context** is a property of communicators (defined next) that allows partitioning of the
 37 communication space. A message sent in one context cannot be received in another context.
 38 Furthermore, where permitted, collective operations are independent of pending point-to-
 39 point operations. Contexts are not explicit MPI objects; they appear only as part of the
 40 realization of communicators (below).
 41

42 *Advice to implementors.* Distinct communicators in the same process have distinct
 43 contexts. A context is essentially a system-managed tag (or tags) needed to make
 44 a communicator safe for point-to-point and MPI-defined collective communication.
 45 Safety means that collective and point-to-point communication within one commu-
 46 nicator do not interfere, and that communication over distinct communicators don’t
 47 interfere.
 48

A possible implementation for a context is as a supplemental tag attached to messages on send and matched on receive. Each intra-communicator stores the value of its two tags (one for point-to-point and one for collective communication). Communicator-generating functions use a collective communication to agree on a new group-wide unique context.

Analogously, in inter-communication, two context tags are stored per communicator, one used by group A to send and group B to receive, and a second used by group B to send and for group A to receive.

Since contexts are not explicit objects, other implementations are also possible. (*End of advice to implementors.*)

6.2.3 Intra-Communicators

Intra-communicators bring together the concepts of group and context. To support implementation-specific optimizations, and application topologies (defined in the next chapter, Chapter 7), communicators may also “cache” additional information (see Section 6.7). MPI communication operations reference communicators to determine the scope and the “communication universe” in which a point-to-point or collective operation is to operate.

Each communicator contains a group of valid participants; this group always includes the local process. The source and destination of a message is identified by process rank within that group.

For collective communication, the intra-communicator specifies the set of processes that participate in the collective operation (and their order, when significant). Thus, the communicator restricts the “spatial” scope of communication, and provides machine-independent process addressing through ranks.

Intra-communicators are represented by opaque **intra-communicator objects**, and hence cannot be directly transferred from one process to another.

6.2.4 Predefined Intra-Communicators

An initial intra-communicator `MPI_COMM_WORLD` of all processes the local process can communicate with after initialization (itself included) is defined once `MPI_INIT` or `MPI_INIT_THREAD` has been called. In addition, the communicator `MPI_COMM_SELF` is provided, which includes only the process itself.

The predefined constant `MPI_COMM_NULL` is the value used for invalid communicator handles.

In a static-process-model implementation of MPI, all processes that participate in the computation are available after MPI is initialized. For this case, `MPI_COMM_WORLD` is a communicator of all processes available for the computation; this communicator has the same value in all processes. In an implementation of MPI where processes can dynamically join an MPI execution, it may be the case that a process starts an MPI computation without having access to all other processes. In such situations, `MPI_COMM_WORLD` is a communicator incorporating all processes with which the joining process can immediately communicate. Therefore, `MPI_COMM_WORLD` may simultaneously represent disjoint groups in different processes.

All MPI implementations are required to provide the `MPI_COMM_WORLD` communicator. It cannot be deallocated during the life of a process. The group corresponding to this communicator does not appear as a pre-defined constant, but it may be accessed using

1 MPI_COMM_GROUP (see below). MPI does not specify the correspondence between the
 2 process rank in MPI_COMM_WORLD and its (machine-dependent) absolute address. Neither
 3 does MPI specify the function of the host process, if any. Other implementation-dependent,
 4 predefined communicators may also be provided.

6.3 Group Management

8 This section describes the manipulation of process groups in MPI. These operations are
 9 local and their execution does not require interprocess communication.

6.3.1 Group Accessors

14 MPI_GROUP_SIZE(group, size)

16	IN	group	group (handle)
17	OUT	size	number of processes in the group (integer)

19
 20 int MPI_Group_size(MPI_Group group, int *size)

21 MPI_Group_size(group, size, ierror) BIND(C)
 22 TYPE(MPI_Group), INTENT(IN) :: group
 23 INTEGER, INTENT(OUT) :: size
 24 INTEGER, OPTIONAL, INTENT(OUT) :: ierror

25
 26 MPI_GROUP_SIZE(GROUP, SIZE, IERROR)
 27 INTEGER GROUP, SIZE, IERROR

28 {int MPI::Group::Get_size() const(*binding deprecated, see Section 15.2*) }

31 MPI_GROUP_RANK(group, rank)

33	IN	group	group (handle)
34	OUT	rank	rank of the calling process in group, or 35 MPI_UNDEFINED if the process is not a member (in- 36 teger)

38
 39 int MPI_Group_rank(MPI_Group group, int *rank)

40 MPI_Group_rank(group, rank, ierror) BIND(C)
 41 TYPE(MPI_Group), INTENT(IN) :: group
 42 INTEGER, INTENT(OUT) :: rank
 43 INTEGER, OPTIONAL, INTENT(OUT) :: ierror

44
 45 MPI_GROUP_RANK(GROUP, RANK, IERROR)
 46 INTEGER GROUP, RANK, IERROR

47 {int MPI::Group::Get_rank() const(*binding deprecated, see Section 15.2*) }

```

MPI_GROUP_TRANSLATE_RANKS (group1, n, ranks1, group2, ranks2) 1
    IN      group1      group1 (handle) 2
    IN      n            number of ranks in ranks1 and ranks2 arrays (integer) 3
    IN      ranks1      array of zero or more valid ranks in group1 4
    IN      group2      group2 (handle) 5
    OUT     ranks2      array of corresponding ranks in group2, 6
                        MPI_UNDEFINED when no correspondence exists. 7
                                                                8
                                                                9
                                                                10
int MPI_Group_translate_ranks (MPI_Group group1, int n, const int *ranks1, 11 ticket140.
                             MPI_Group group2, int *ranks2) 12
MPI_Group_translate_ranks(group1, n, ranks1, group2, ranks2, ierror) 13 ticket-248T.
    BIND(C) 14
    TYPE(MPI_Group), INTENT(IN) :: group1, group2 15
    INTEGER, INTENT(IN) :: n, ranks1(n) 16
    INTEGER, INTENT(OUT) :: ranks2(n) 17
    INTEGER, OPTIONAL, INTENT(OUT) :: ierror 18
                                                                19
MPI_GROUP_TRANSLATE_RANKS(GROUP1, N, RANKS1, GROUP2, RANKS2, IERROR) 20
    INTEGER GROUP1, N, RANKS1(*), GROUP2, RANKS2(*), IERROR 21
                                                                22
{static void MPI::Group::Translate_ranks (const MPI::Group& group1, int n, 23
    const int ranks1[], const MPI::Group& group2, 24
    int ranks2[]) (binding deprecated, see Section 15.2) } 25

```

This function is important for determining the relative numbering of the same processes in two different groups. For instance, if one knows the ranks of certain processes in the group of MPI_COMM_WORLD, one might want to know their ranks in a subset of that group.

MPI_PROC_NULL is a valid rank for input to MPI_GROUP_TRANSLATE_RANKS, which returns MPI_PROC_NULL as the translated rank.

```

MPI_GROUP_COMPARE(group1, group2, result) 32
    IN      group1      first group (handle) 34
    IN      group2      second group (handle) 35
    OUT     result      result (integer) 36
                                                                37
                                                                38
int MPI_Group_compare(MPI_Group group1, MPI_Group group2, int *result) 39
MPI_Group_compare(group1, group2, result, ierror) BIND(C) 40 ticket-248T.
    TYPE(MPI_Group), INTENT(IN) :: group1, group2 41
    INTEGER, INTENT(OUT) :: result 42
    INTEGER, OPTIONAL, INTENT(OUT) :: ierror 43
                                                                44
MPI_GROUP_COMPARE(GROUP1, GROUP2, RESULT, IERROR) 45
    INTEGER GROUP1, GROUP2, RESULT, IERROR 46
                                                                47
                                                                48

```

```

1 {static int MPI::Group::Compare(const MPI::Group& group1,
2     const MPI::Group& group2) (binding deprecated, see Section 15.2) }
```

MPI_IDENT results if the group members and group order is exactly the same in both groups. This happens for instance if group1 and group2 are the same handle. MPI_SIMILAR results if the group members are the same but the order is different. MPI_UNEQUAL results otherwise.

6.3.2 Group Constructors

Group constructors are used to subset and superset existing groups. These constructors construct new groups from existing groups. These are local operations, and distinct groups may be defined on different processes; a process may also define a group that does not include itself. Consistent definitions are required when groups are used as arguments in communicator-building functions. MPI does not provide a mechanism to build a group from scratch, but only from other, previously defined groups. The base group, upon which all other groups are defined, is the group associated with the initial communicator MPI_COMM_WORLD (accessible through the function MPI_COMM_GROUP).

Rationale. In what follows, there is no group duplication function analogous to MPI_COMM_DUP, defined later in this chapter. There is no need for a group duplicator. A group, once created, can have several references to it by making copies of the handle. The following constructors address the need for subsets and supersets of existing groups. (*End of rationale.*)

Advice to implementors. Each group constructor behaves as if it returned a new group object. When this new group is a copy of an existing group, then one can avoid creating such new objects, using a reference-count mechanism. (*End of advice to implementors.*)

```

30 MPI_COMM_GROUP(comm, group)
```

32	IN	comm	communicator (handle)
33	OUT	group	group corresponding to comm (handle)

```

35 int MPI_Comm_group(MPI_Comm comm, MPI_Group *group)
```

```

36 MPI_Comm_group(comm, group, ierror) BIND(C)
37     TYPE(MPI_Comm), INTENT(IN) :: comm
38     TYPE(MPI_Group), INTENT(OUT) :: group
39     INTEGER, OPTIONAL, INTENT(OUT) :: ierror
```

```

40 MPI_COMM_GROUP(COMM, GROUP, IERROR)
41     INTEGER COMM, GROUP, IERROR
```

```

42 {MPI::Group MPI::Comm::Get_group() const (binding deprecated, see Section 15.2) }
```

MPI_COMM_GROUP returns in group a handle to the group of comm.

```

MPI_GROUP_UNION(group1, group2, newgroup) 1
    IN      group1      first group (handle) 2
    IN      group2      second group (handle) 3
    OUT     newgroup     union group (handle) 4
                                           5
                                           6
int MPI_Group_union(MPI_Group group1, MPI_Group group2, 7
                    MPI_Group *newgroup) 8
MPI_Group_union(group1, group2, newgroup, ierror) BIND(C) 9 ticket-248T.
    TYPE(MPI_Group), INTENT(IN) :: group1, group2 10
    TYPE(MPI_Group), INTENT(OUT) :: newgroup 11
    INTEGER, OPTIONAL, INTENT(OUT) :: ierror 12
MPI_GROUP_UNION(GROUP1, GROUP2, NEWGROUP, IERROR) 13
    INTEGER GROUP1, GROUP2, NEWGROUP, IERROR 14
{static MPI::Group MPI::Group::Union(const MPI::Group& group1, 15
                                     const MPI::Group& group2) (binding deprecated, see Section 15.2) } 16
                                           17
                                           18
                                           19
                                           20
MPI_GROUP_INTERSECTION(group1, group2, newgroup) 21
    IN      group1      first group (handle) 22
    IN      group2      second group (handle) 23
    OUT     newgroup     intersection group (handle) 24
                                           25
                                           26
int MPI_Group_intersection(MPI_Group group1, MPI_Group group2, 27
                          MPI_Group *newgroup) 28
MPI_Group_intersection(group1, group2, newgroup, ierror) BIND(C) 29 ticket-248T.
    TYPE(MPI_Group), INTENT(IN) :: group1, group2 30
    TYPE(MPI_Group), INTENT(OUT) :: newgroup 31
    INTEGER, OPTIONAL, INTENT(OUT) :: ierror 32
MPI_GROUP_INTERSECTION(GROUP1, GROUP2, NEWGROUP, IERROR) 33
    INTEGER GROUP1, GROUP2, NEWGROUP, IERROR 34
{static MPI::Group MPI::Group::Intersect(const MPI::Group& group1, 35
                                          const MPI::Group& group2) (binding deprecated, see Section 15.2) } 36
                                           37
                                           38
                                           39
                                           40
MPI_GROUP_DIFFERENCE(group1, group2, newgroup) 41
    IN      group1      first group (handle) 42
    IN      group2      second group (handle) 43
    OUT     newgroup     difference group (handle) 44
                                           45
                                           46
int MPI_Group_difference(MPI_Group group1, MPI_Group group2, 47
                        MPI_Group *newgroup) 48

```

```

1
ticket-248T. 2 MPI_Group_difference(group1, group2, newgroup, ierror) BIND(C)
3     TYPE(MPI_Group), INTENT(IN) :: group1, group2
4     TYPE(MPI_Group), INTENT(OUT) :: newgroup
5     INTEGER, OPTIONAL, INTENT(OUT) :: ierror
6
7 MPI_GROUP_DIFFERENCE(GROUP1, GROUP2, NEWGROUP, IERROR)
8     INTEGER GROUP1, GROUP2, NEWGROUP, IERROR
9
10 {static MPI::Group MPI::Group::Difference(const MPI::Group& group1,
11     const MPI::Group& group2) (binding deprecated, see Section 15.2) }

```

The set-like operations are defined as follows:

union All elements of the first group (group1), followed by all elements of second group (group2) not in first.

intersect all elements of the first group that are also in the second group, ordered as in first group.

difference all elements of the first group that are not in the second group, ordered as in the first group.

Note that for these operations the order of processes in the output group is determined primarily by order in the first group (if possible) and then, if necessary, by order in the second group. Neither union nor intersection are commutative, but both are associative.

The new group can be empty, that is, equal to MPI_GROUP_EMPTY.

```

26 MPI_GROUP_INCL(group, n, ranks, newgroup)

```

27	IN	group	group (handle)
28			
29	IN	n	number of elements in array ranks (and size of
30			newgroup) (integer)
31	IN	ranks	ranks of processes in group to appear in
32			newgroup (array of integers)
33	OUT	newgroup	new group derived from above, in the order defined by
34			ranks (handle)
35			

```

36
ticket140. 37 int MPI_Group_incl(MPI_Group group, int n, const int *ranks,
38     MPI_Group *newgroup)

```

```

ticket229.1. 39 MPI_Group_incl(group, n, ranks, newgroup, ierror) BIND(C)
ticket-248T. 40     TYPE(MPI_Group), INTENT(IN) :: group
41     INTEGER, INTENT(IN) :: n, ranks(n)
42     TYPE(MPI_Group), INTENT(OUT) :: newgroup
43     INTEGER, OPTIONAL, INTENT(OUT) :: ierror

```

```

44 MPI_GROUP_INCL(GROUP, N, RANKS, NEWGROUP, IERROR)
45     INTEGER GROUP, N, RANKS(*), NEWGROUP, IERROR

```

```

47 {MPI::Group MPI::Group::Incl(int n, const int ranks[]) const (binding
48     deprecated, see Section 15.2) }

```

The function `MPI_GROUP_INCL` creates a group `newgroup` that consists of the `n` processes in `group` with ranks `ranks[0], ..., ranks[n-1]`; the process with rank `i` in `newgroup` is the process with rank `ranks[i]` in `group`. Each of the `n` elements of `ranks` must be a valid rank in `group` and all elements must be distinct, or else the program is erroneous. If `n = 0`, then `newgroup` is `MPI_GROUP_EMPTY`. This function can, for instance, be used to reorder the elements of a group. See also `MPI_GROUP_COMPARE`.

`MPI_GROUP_EXCL(group, n, ranks, newgroup)`

IN	group	group (handle)
IN	n	number of elements in array <code>ranks</code> (integer)
IN	ranks	array of integer ranks in <code>group</code> not to appear in <code>newgroup</code>
OUT	newgroup	new group derived from above, preserving the order defined by <code>group</code> (handle)

```
int MPI_Group_excl(MPI_Group group, int n, const int *ranks,
                  MPI_Group *newgroup)
```

```
MPI_Group_excl(group, n, ranks, newgroup, ierror) BIND(C)
```

```
    TYPE(MPI_Group), INTENT(IN) :: group
```

```
    INTEGER, INTENT(IN) :: n, ranks(n)
```

```
    TYPE(MPI_Group), INTENT(OUT) :: newgroup
```

```
    INTEGER, OPTIONAL, INTENT(OUT) :: ierror
```

```
MPI_GROUP_EXCL(GROUP, N, RANKS, NEWGROUP, IERROR)
```

```
    INTEGER GROUP, N, RANKS(*), NEWGROUP, IERROR
```

```
{MPI::Group MPI::Group::Excl(int n, const int ranks[]) const(binding
    deprecated, see Section 15.2) }
```

The function `MPI_GROUP_EXCL` creates a group of processes `newgroup` that is obtained by deleting from `group` those processes with ranks `ranks[0] ... ranks[n-1]`. The ordering of processes in `newgroup` is identical to the ordering in `group`. Each of the `n` elements of `ranks` must be a valid rank in `group` and all elements must be distinct; otherwise, the program is erroneous. If `n = 0`, then `newgroup` is identical to `group`.

`MPI_GROUP_RANGE_INCL(group, n, ranges, newgroup)`

IN	group	group (handle)
IN	n	number of triplets in array <code>ranges</code> (integer)
IN	ranges	a one-dimensional array of integer triplets, of the form (first rank, last rank, stride) indicating ranks in <code>group</code> of processes to be included in <code>newgroup</code>
OUT	newgroup	new group derived from above, in the order defined by <code>ranges</code> (handle)

```

1 int MPI_Group_range_incl(MPI_Group group, int n, int ranges[][3],
2 MPI_Group *newgroup)

```

```

3 MPI_Group_range_incl(group, n, ranges, newgroup, ierror) BIND(C)
4 TYPE(MPI_Group), INTENT(IN) :: group
5 INTEGER, INTENT(IN) :: n, ranges(3,n)
6 TYPE(MPI_Group), INTENT(OUT) :: newgroup
7 INTEGER, OPTIONAL, INTENT(OUT) :: ierror

```

```

8 MPI_GROUP_RANGE_INCL(GROUP, N, RANGES, NEWGROUP, IERROR)
9 INTEGER GROUP, N, RANGES(3,*), NEWGROUP, IERROR

```

```

10 {MPI::Group MPI::Group::Range_incl(int n, const int ranges[][3])
11 const(binding deprecated, see Section 15.2) }

```

If ranges consist of the triplets

$$(first_1, last_1, stride_1), \dots, (first_n, last_n, stride_n)$$

then newgroup consists of the sequence of processes in group with ranks

$$first_1, first_1 + stride_1, \dots, first_1 + \left\lfloor \frac{last_1 - first_1}{stride_1} \right\rfloor stride_1, \dots$$

$$first_n, first_n + stride_n, \dots, first_n + \left\lfloor \frac{last_n - first_n}{stride_n} \right\rfloor stride_n.$$

Each computed rank must be a valid rank in group and all computed ranks must be distinct, or else the program is erroneous. Note that we may have $first_i > last_i$, and $stride_i$ may be negative, but cannot be zero.

The functionality of this routine is specified to be equivalent to expanding the array of ranges to an array of the included ranks and passing the resulting array of ranks and other arguments to MPI_GROUP_INCL. A call to MPI_GROUP_INCL is equivalent to a call to MPI_GROUP_RANGE_INCL with each rank i in ranks replaced by the triplet $(i, i, 1)$ in the argument ranges.

```

34 MPI_GROUP_RANGE_EXCL(group, n, ranges, newgroup)

```

35	IN	group	group (handle)
36			
37	IN	n	number of elements in array ranges (integer)
38	IN	ranges	a one-dimensional array of integer triplets of the form (first rank, last rank, stride), indicating the ranks in group of processes to be excluded from the output group newgroup.
39			
40			
41			
42	OUT	newgroup	new group derived from above, preserving the order in group (handle)
43			
44			

```

45 int MPI_Group_range_excl(MPI_Group group, int n, int ranges[][3],
46 MPI_Group *newgroup)

```

```

47 MPI_Group_range_excl(group, n, ranges, newgroup, ierror) BIND(C)

```



```

TYPE(MPI_Group), INTENT(IN) :: group
INTEGER, INTENT(IN) :: n, ranges(3,n)
TYPE(MPI_Group), INTENT(OUT) :: newgroup
INTEGER, OPTIONAL, INTENT(OUT) :: ierror
MPI_GROUP_RANGE_EXCL(GROUP, N, RANGES, NEWGROUP, IERROR)
INTEGER GROUP, N, RANGES(3,*), NEWGROUP, IERROR
{MPI::Group MPI::Group::Range_excl(int n, const int ranges[] [3])
  const(binding deprecated, see Section 15.2) }

```

Each computed rank must be a valid rank in group and all computed ranks must be distinct, or else the program is erroneous.

The functionality of this routine is specified to be equivalent to expanding the array of ranges to an array of the excluded ranks and passing the resulting array of ranks and other arguments to MPI_GROUP_EXCL. A call to MPI_GROUP_EXCL is equivalent to a call to MPI_GROUP_RANGE_EXCL with each rank *i* in ranks replaced by the triplet (*i*,*i*,1) in the argument ranges.

Advice to users. The range operations do not explicitly enumerate ranks, and therefore are more scalable if implemented efficiently. Hence, we recommend MPI programmers to use them whenever possible, as high-quality implementations will take advantage of this fact. (*End of advice to users.*)

Advice to implementors. The range operations should be implemented, if possible, without enumerating the group members, in order to obtain better scalability (time and space). (*End of advice to implementors.*)

6.3.3 Group Destructors

```

MPI_GROUP_FREE(group)
INOUT group group (handle)
int MPI_Group_free(MPI_Group *group)
MPI_Group_free(group, ierror) BIND(C)
TYPE(MPI_Group), INTENT(INOUT) :: group
INTEGER, OPTIONAL, INTENT(OUT) :: ierror
MPI_GROUP_FREE(GROUP, IERROR)
INTEGER GROUP, IERROR
{void MPI::Group::Free() (binding deprecated, see Section 15.2) }

```

This operation marks a group object for deallocation. The handle `group` is set to MPI_GROUP_NULL by the call. Any on-going operation using this group will complete normally.

Advice to implementors. One can keep a reference count that is incremented for each call to MPI_COMM_GROUP, MPI_COMM_CREATE and MPI_COMM_DUP, and

1 decremented for each call to `MPI_GROUP_FREE` or `MPI_COMM_FREE`; the group
 2 object is ultimately deallocated when the reference count drops to zero. (*End of*
 3 *advice to implementors.*)
 4

5 6.4 Communicator Management

7 This section describes the manipulation of communicators in MPI. Operations that access
 8 communicators are local and their execution does not require interprocess communication.
 9 Operations that create communicators are collective and may require interprocess commu-
 10 nication.
 11

12 *Advice to implementors.* High-quality implementations should amortize the over-
 13 heads associated with the creation of communicators (for the same group, or subsets
 14 thereof) over several calls, by allocating multiple contexts with one collective commu-
 15 nication. (*End of advice to implementors.*)
 16

17 6.4.1 Communicator Accessors

18 The following are all local operations.
 19

20
 21 `MPI_COMM_SIZE(comm, size)`

22	IN	comm	communicator (handle)
23	OUT	size	number of processes in the group of comm (integer)

24
 25
 26
 27 `int MPI_Comm_size(MPI_Comm comm, int *size)`

28 `MPI_Comm_size(comm, size, ierror) BIND(C)`
 29 `TYPE(MPI_Comm), INTENT(IN) :: comm`
 30 `INTEGER, INTENT(OUT) :: size`
 31 `INTEGER, OPTIONAL, INTENT(OUT) :: ierror`
 32

33 `MPI_COMM_SIZE(COMM, SIZE, IERROR)`
 34 `INTEGER COMM, SIZE, IERROR`

35 `{int MPI::Comm::Get_size() const(binding deprecated, see Section 15.2) }`
 36

37
 38 *Rationale.* This function is equivalent to accessing the communicator's group with
 39 `MPI_COMM_GROUP` (see above), computing the size using `MPI_GROUP_SIZE`, and
 40 then freeing the temporary group via `MPI_GROUP_FREE`. However, this function is
 41 so commonly used, that this shortcut was introduced. (*End of rationale.*)

42
 43 *Advice to users.* This function indicates the number of processes involved in a
 44 communicator. For `MPI_COMM_WORLD`, it indicates the total number of processes
 45 available (for this version of MPI, there is no standard way to change the number of
 46 processes once initialization has taken place).

47 This call is often used with the next call to determine the amount of concurrency
 48 available for a specific library or program. The following call, `MPI_COMM_RANK`

indicates the rank of the process that calls it in the range from 0 . . .size−1, where size is the return value of MPI_COMM_SIZE. (*End of advice to users.*)

MPI_COMM_RANK(comm, rank)

IN	comm	communicator (handle)
OUT	rank	rank of the calling process in group of comm (integer)

```
int MPI_Comm_rank(MPI_Comm comm, int *rank)
```

```
MPI_Comm_rank(comm, rank, ierror) BIND(C)
  TYPE(MPI_Comm), INTENT(IN) :: comm
  INTEGER, INTENT(OUT) :: rank
  INTEGER, OPTIONAL, INTENT(OUT) :: ierror
```

```
MPI_COMM_RANK(COMM, RANK, IERROR)
  INTEGER COMM, RANK, IERROR
```

```
{int MPI::Comm::Get_rank() const(binding deprecated, see Section 15.2) }
```

Rationale. This function is equivalent to accessing the communicator’s group with MPI_COMM_GROUP (see above), computing the rank using MPI_GROUP_RANK, and then freeing the temporary group via MPI_GROUP_FREE. However, this function is so commonly used, that this shortcut was introduced. (*End of rationale.*)

Advice to users. This function gives the rank of the process in the particular communicator’s group. It is useful, as noted above, in conjunction with MPI_COMM_SIZE.

Many programs will be written with the master-slave model, where one process (such as the rank-zero process) will play a supervisory role, and the other processes will serve as compute nodes. In this framework, the two preceding calls are useful for determining the roles of the various processes of a communicator. (*End of advice to users.*)

MPI_COMM_COMPARE(comm1, comm2, result)

IN	comm1	first communicator (handle)
IN	comm2	second communicator (handle)
OUT	result	result (integer)

```
int MPI_Comm_compare(MPI_Comm comm1, MPI_Comm comm2, int *result)
```

```
MPI_Comm_compare(comm1, comm2, result, ierror) BIND(C)
  TYPE(MPI_Comm), INTENT(IN) :: comm1, comm2
  INTEGER, INTENT(OUT) :: result
  INTEGER, OPTIONAL, INTENT(OUT) :: ierror
```

```
1 MPI_COMM_COMPARE(COMM1, COMM2, RESULT, IERROR)
```

```
2     INTEGER COMM1, COMM2, RESULT, IERROR
```

```
3 {static int MPI::Comm::Compare(const MPI::Comm& comm1,
4     const MPI::Comm& comm2) (binding deprecated, see Section 15.2) }
```

6 MPI_IDENT results if and only if comm1 and comm2 are handles for the same object (identical groups and same contexts). MPI_CONGRUENT results if the underlying groups are identical in constituents and rank order; these communicators differ only by context. MPI_SIMILAR results if the group members of both communicators are the same but the rank order differs. MPI_UNEQUAL results otherwise.

12 6.4.2 Communicator Constructors

14 The following are collective functions that are invoked by all processes in the group or groups associated with comm.

16 *Rationale.* Note that there is a chicken-and-egg aspect to MPI in that a communicator is needed to create a new communicator. The base communicator for all MPI communicators is predefined outside of MPI, and is MPI_COMM_WORLD. This model was arrived at after considerable debate, and was chosen to increase “safety” of programs written in MPI. (*End of rationale.*)

22 The MPI interface provides four communicator construction routines that apply to both intracommunicators and intercommunicators. The construction routine MPI_INTERCOMM_CREATE (discussed later) applies only to intercommunicators.

26 An intracommunicator involves a single group while an intercommunicator involves two groups. Where the following discussions address intercommunicator semantics, the two groups in an intercommunicator are called the *left* and *right* groups. A process in an intercommunicator is a member of either the left or the right group. From the point of view of that process, the group that the process is a member of is called the *local* group; the other group (relative to that process) is the *remote* group. The left and right group labels give us a way to describe the two groups in an intercommunicator that is not relative to any particular process (as the local and remote groups are).

```
35 MPI_COMM_DUP(comm, newcomm)
```

```
36     IN      comm      communicator (handle)
```

```
38     OUT    newcomm   copy of comm (handle)
```

```
40 int MPI_Comm_dup(MPI_Comm comm, MPI_Comm *newcomm)
```

```
41 MPI_Comm_dup(comm, newcomm, ierror) BIND(C)
```

```
42     TYPE(MPI_Comm), INTENT(IN) :: comm
```

```
43     TYPE(MPI_Comm), INTENT(OUT) :: newcomm
```

```
44     INTEGER, OPTIONAL, INTENT(OUT) :: ierror
```

```
46 MPI_COMM_DUP(COMM, NEWCOMM, IERROR)
```

```
47     INTEGER COMM, NEWCOMM, IERROR
```

```

{MPI::Intracomm MPI::Intracomm::Dup() const(binding deprecated, see Section 15.2) } 1
    } 2
{MPI::Intercomm MPI::Intercomm::Dup() const(binding deprecated, see Section 15.2) } 3
    } 4
{MPI::Cartcomm MPI::Cartcomm::Dup() const(binding deprecated, see Section 15.2) } 5
{MPI::Graphcomm MPI::Graphcomm::Dup() const(binding deprecated, see Section 15.2) } 6
    } 7
{MPI::Distgraphcomm MPI::Distgraphcomm::Dup() const(binding deprecated, see 8
    Section 15.2) } 9
{MPI::Comm& MPI::Comm::Clone() const = 0(binding deprecated, see Section 15.2) } 10
{MPI::Intracomm& MPI::Intracomm::Clone() const(binding deprecated, see 11
    Section 15.2) } 12
{MPI::Intercomm& MPI::Intercomm::Clone() const(binding deprecated, see 13
    Section 15.2) } 14
{MPI::Cartcomm& MPI::Cartcomm::Clone() const(binding deprecated, see Section 15.2) } 15
    } 16
{MPI::Graphcomm& MPI::Graphcomm::Clone() const(binding deprecated, see 17
    Section 15.2) } 18
{MPI::Distgraphcomm& MPI::Distgraphcomm::Clone() const(binding deprecated, see 19
    Section 15.2) } 20
    } 21
    } 22
    } 23
    } 24
    } 25
    } 26

```

MPI_COMM_DUP Duplicates the existing communicator `comm` with associated key values. For each key value, the respective copy callback function determines the attribute value associated with this key in the new communicator; one particular action that a copy callback may take is to delete the attribute from the new communicator. Returns in `newcomm` a new communicator with the same group or groups, any copied cached information, but a new context (see Section 6.7.1). Please see Section 16.1.7 on page 638 for further discussion about the C++ bindings for `Dup()` and `Clone()`.

Advice to users. This operation is used to provide a parallel library call with a duplicate communication space that has the same properties as the original communicator. This includes any attributes (see below), and topologies (see Chapter 7). This call is valid even if there are pending point-to-point communications involving the communicator `comm`. A typical call might involve a `MPI_COMM_DUP` at the beginning of the parallel call, and an `MPI_COMM_FREE` of that duplicated communicator at the end of the call. Other models of communicator management are also possible.

This call applies to both intra- and inter-communicators. (*End of advice to users.*)

Advice to implementors. One need not actually copy the group information, but only add a new reference and increment the reference count. Copy on write can be used for the cached information. (*End of advice to implementors.*)

```

1 MPI_COMM_CREATE(comm, group, newcomm)
2     IN      comm      communicator (handle)
3
4     IN      group     Group, which is a subset of the group of
5                   comm (handle)
6
7     OUT     newcomm   new communicator (handle)
8
9 int MPI_Comm_create(MPI_Comm comm, MPI_Group group, MPI_Comm *newcomm)
10 MPI_Comm_create(comm, group, newcomm, ierror) BIND(C)
11     TYPE(MPI_Comm), INTENT(IN) :: comm
12     TYPE(MPI_Group), INTENT(IN) :: group
13     TYPE(MPI_Comm), INTENT(OUT) :: newcomm
14     INTEGER, OPTIONAL, INTENT(OUT) :: ierror
15
16 MPI_COMM_CREATE(COMM, GROUP, NEWCOMM, IERROR)
17     INTEGER COMM, GROUP, NEWCOMM, IERROR
18 {MPI::Intercomm MPI::Intercomm::Create(const MPI::Group& group)
19     const(binding deprecated, see Section 15.2) }
20
21 {MPI::Intracomm MPI::Intracomm::Create(const MPI::Group& group)
22     const(binding deprecated, see Section 15.2) }

```

If `comm` is an intracommunicator, this function returns a new communicator `newcomm` with communication group defined by the `group` argument. No cached information propagates from `comm` to `newcomm`. Each process must call with a `group` argument that is a subgroup of the `group` associated with `comm`; this could be `MPI_GROUP_EMPTY`. The processes may specify different values for the `group` argument. If a process calls with a non-empty `group` then all processes in that `group` must call the function with the same `group` as argument, that is the same processes in the same order. Otherwise the call is erroneous. This implies that the set of groups specified across the processes must be disjoint. If the calling process is a member of the group given as `group` argument, then `newcomm` is a communicator with `group` as its associated group. In the case that a process calls with a `group` to which it does not belong, e.g., `MPI_GROUP_EMPTY`, then `MPI_COMM_NULL` is returned as `newcomm`. The function is collective and must be called by all processes in the group of `comm`.

Rationale. The interface supports the original mechanism from MPI-1.1, which required the same `group` in all processes of `comm`. It was extended in MPI-2.2 to allow the use of disjoint subgroups in order to allow implementations to eliminate unnecessary communication that `MPI_COMM_SPLIT` would incur when the user already knows the membership of the disjoint subgroups. (*End of rationale.*)

Rationale. The requirement that the entire group of `comm` participate in the call stems from the following considerations:

- It allows the implementation to layer `MPI_COMM_CREATE` on top of regular collective communications.
- It provides additional safety, in particular in the case where partially overlapping groups are used to create new communicators.

- It permits implementations sometimes to avoid communication related to context creation.

(End of rationale.)

Advice to users. MPI_COMM_CREATE provides a means to subset a group of processes for the purpose of separate MIMD computation, with separate communication space. newcomm, which emerges from MPI_COMM_CREATE can be used in subsequent calls to MPI_COMM_CREATE (or other communicator constructors) further to subdivide a computation into parallel sub-computations. A more general service is provided by MPI_COMM_SPLIT, below. *(End of advice to users.)*

Advice to implementors. When calling MPI_COMM_DUP, all processes call with the same group (the group associated with the communicator). When calling MPI_COMM_CREATE, the processes provide the same group or disjoint subgroups. For both calls, it is theoretically possible to agree on a group-wide unique context with no communication. However, local execution of these functions requires use of a larger context name space and reduces error checking. Implementations may strike various compromises between these conflicting goals, such as bulk allocation of multiple contexts in one collective operation.

Important: If new communicators are created without synchronizing the processes involved then the communication system should be able to cope with messages arriving in a context that has not yet been allocated at the receiving process. *(End of advice to implementors.)*

If comm is an intercommunicator, then the output communicator is also an intercommunicator where the local group consists only of those processes contained in group (see Figure 6.1). The group argument should only contain those processes in the local group of the input intercommunicator that are to be a part of newcomm. All processes in the same local group of comm must specify the same value for group, i.e., the same members in the same order. If either group does not specify at least one process in the local group of the intercommunicator, or if the calling process is not included in the group, MPI_COMM_NULL is returned.

Rationale. In the case where either the left or right group is empty, a null communicator is returned instead of an intercommunicator with MPI_GROUP_EMPTY because the side with the empty group must return MPI_COMM_NULL. *(End of rationale.)*

Example 6.1 The following example illustrates how the first node in the left side of an intercommunicator could be joined with all members on the right side of an intercommunicator to form a new intercommunicator.

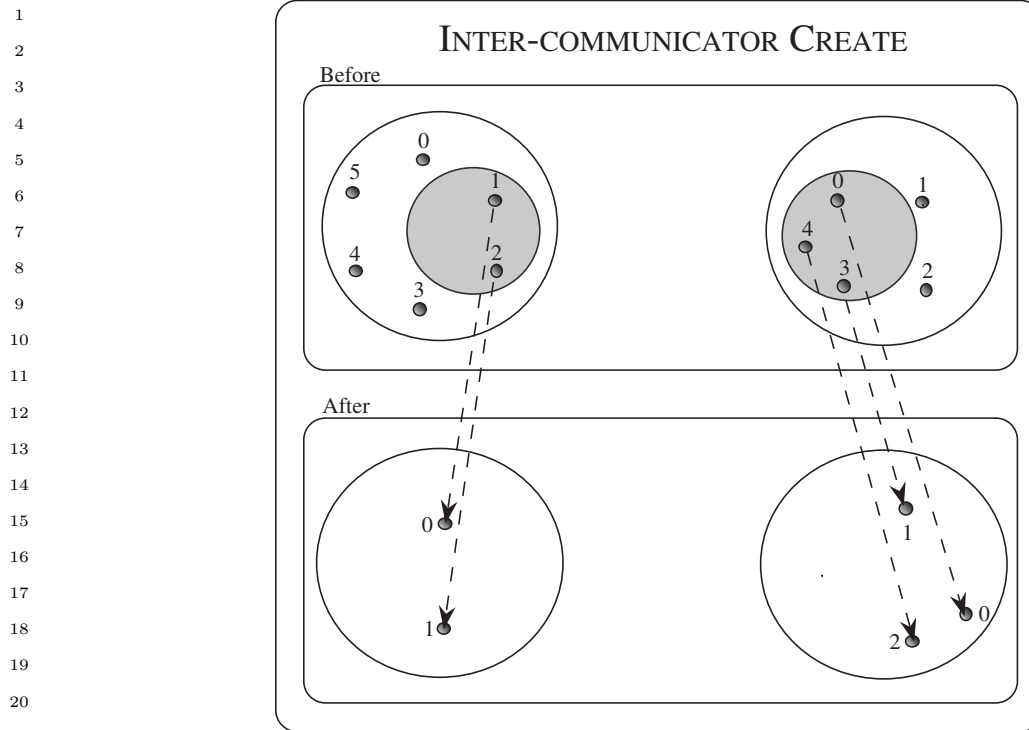

22 Figure 6.1: Intercommunicator create using `MPI_COMM_CREATE` extended to intercom-
23 municators. The input groups are those in the grey circle.
24

25

```

26 MPI_Comm inter_comm, new_inter_comm;
27 MPI_Group local_group, group;
28 int rank = 0; /* rank on left side to include in
29                new inter-comm */
30
31 /* Construct the original intercommunicator: "inter_comm" */
32 ...
33
34 /* Construct the group of processes to be in new
35    intercommunicator */
36 if (/* I'm on the left side of the intercommunicator */) {
37     MPI_Comm_group ( inter_comm, &local_group );
38     MPI_Group_incl ( local_group, 1, &rank, &group );
39     MPI_Group_free ( &local_group );
40 }
41 else
42     MPI_Comm_group ( inter_comm, &group );
43
44 MPI_Comm_create ( inter_comm, group, &new_inter_comm );
45 MPI_Group_free( &group );
46
47
48
```



```

MPI_COMM_SPLIT(comm, color, key, newcomm)
    IN      comm      communicator (handle)
    IN      color     control of subset assignment (integer)
    IN      key       control of rank assignment (integer)
    OUT     newcomm   new communicator (handle)

int MPI_Comm_split(MPI_Comm comm, int color, int key, MPI_Comm *newcomm)
MPI_Comm_split(comm, color, key, newcomm, ierror) BIND(C)
    TYPE(MPI_Comm), INTENT(IN) :: comm
    INTEGER, INTENT(IN) :: color, key
    TYPE(MPI_Comm), INTENT(OUT) :: newcomm
    INTEGER, OPTIONAL, INTENT(OUT) :: ierror

MPI_COMM_SPLIT(COMM, COLOR, KEY, NEWCOMM, IERROR)
    INTEGER COMM, COLOR, KEY, NEWCOMM, IERROR

{MPI::Intercomm MPI::Intercomm::Split(int color, int key) const(binding
    deprecated, see Section 15.2) }

{MPI::Intracomm MPI::Intracomm::Split(int color, int key) const(binding
    deprecated, see Section 15.2) }

```

This function partitions the group associated with `comm` into disjoint subgroups, one for each value of `color`. Each subgroup contains all processes of the same color. Within each subgroup, the processes are ranked in the order defined by the value of the argument `key`, with ties broken according to their rank in the old group. A new communicator is created for each subgroup and returned in `newcomm`. A process may supply the color value `MPI_UNDEFINED`, in which case `newcomm` returns `MPI_COMM_NULL`. This is a collective call, but each process is permitted to provide different values for `color` and `key`.

With an intracommunicator `comm`, a call to `MPI_COMM_CREATE(comm, group, newcomm)` is equivalent to a call to `MPI_COMM_SPLIT(comm, color, key, newcomm)`, where processes that are members of their `group` argument provide `color = number of the group` (based on a unique numbering of all disjoint groups) and `key = rank in group`, and all processes that are not members of their `group` argument provide `color = MPI_UNDEFINED`.

The value of `color` must be non-negative.

Advice to users. This is an extremely powerful mechanism for dividing a single communicating group of processes into k subgroups, with k chosen implicitly by the user (by the number of colors asserted over all the processes). Each resulting communicator will be non-overlapping. Such a division could be useful for defining a hierarchy of computations, such as for multigrid, or linear algebra. For intracommunicators, `MPI_COMM_SPLIT` provides similar capability as `MPI_COMM_CREATE` to split a communicating group into disjoint subgroups. `MPI_COMM_SPLIT` is useful when some processes do not have complete information of the other members in their group, but all processes know (the color of) the group to which they belong. In this case, the MPI implementation discovers the other group members via communication. `MPI_COMM_CREATE` is useful when all processes have complete information

ticket-248T.

1 of the members of their group. In this case, MPI can avoid the extra communication
 2 required to discover group membership.

3 Multiple calls to MPI_COMM_SPLIT can be used to overcome the requirement that
 4 any call have no overlap of the resulting communicators (each process is of only one
 5 color per call). In this way, multiple overlapping communication structures can be
 6 created. Creative use of the color and key in such splitting operations is encouraged.

7 Note that, for a fixed color, the keys need not be unique. It is MPI_COMM_SPLIT's
 8 responsibility to sort processes in ascending order according to this key, and to break
 9 ties in a consistent way. If all the keys are specified in the same way, then all the
 10 processes in a given color will have the relative rank order as they did in their parent
 11 group.
 12 group.

13 Essentially, making the key value zero for all processes of a given color means that one
 14 doesn't really care about the rank-order of the processes in the new communicator.
 15 (*End of advice to users.*)

16 *Rationale.* color is restricted to be non-negative, so as not to conflict with the value
 17 assigned to MPI_UNDEFINED. (*End of rationale.*)

18 The result of MPI_COMM_SPLIT on an intercommunicator is that those processes on the
 19 left with the same color as those processes on the right combine to create a new intercom-
 20 municator. The key argument describes the relative rank of processes on each side of the
 21 intercommunicator (see Figure 6.2). For those colors that are specified only on one side of
 22 the intercommunicator, MPI_COMM_NULL is returned. MPI_COMM_NULL is also returned
 23 to those processes that specify MPI_UNDEFINED as the color.
 24 to those processes that specify MPI_UNDEFINED as the color.
 25 to those processes that specify MPI_UNDEFINED as the color.

26 *Advice to users.* For intercommunicators, MPI_COMM_SPLIT is more general than
 27 MPI_COMM_CREATE. A single call to MPI_COMM_SPLIT can create a set of disjoint
 28 intercommunicators, while a call to MPI_COMM_CREATE creates only one. (*End of*
 29 *advice to users.*)
 30 *advice to users.*)

31 **Example 6.2** (Parallel client-server model). The following client code illustrates how clients
 32 on the left side of an intercommunicator could be assigned to a single server from a pool of
 33 servers on the right side of an intercommunicator.
 34 servers on the right side of an intercommunicator.

```

35        /* Client code */
36        MPI_Comm  multiple_server_comm;
37        MPI_Comm  single_server_comm;
38        int       color, rank, num_servers;
39
40        /* Create intercommunicator with clients and servers:
41           multiple_server_comm */
42        ...
43
44        /* Find out the number of servers available */
45        MPI_Comm_remote_size ( multiple_server_comm, &num_servers );
46
47        /* Determine my color */
48        MPI_Comm_rank ( multiple_server_comm, &rank );

```

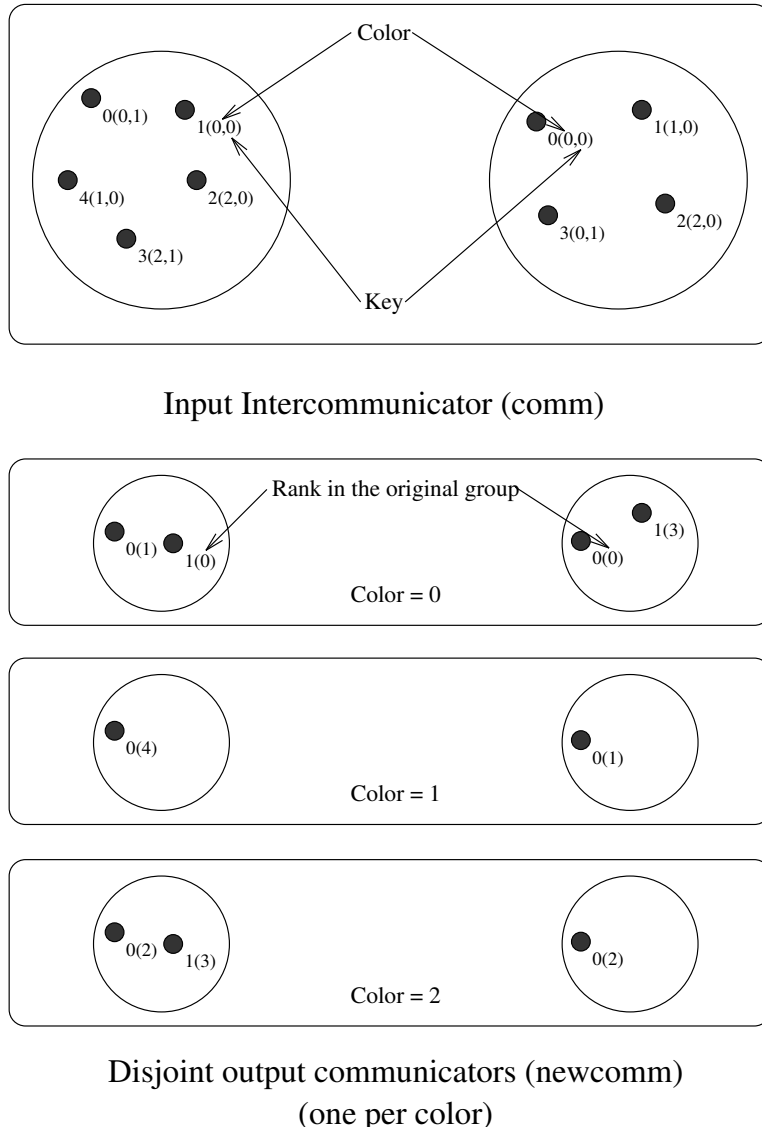

Figure 6.2: Intercommunicator construction achieved by splitting an existing intercommunicator with MPI_COMM_SPLIT extended to intercommunicators.

1
2
3
4
5
6
7
8
9
10
11
12
13
14
15
16
17
18
19
20
21
22
23
24
25
26
27
28
29
30
31
32
33
34
35
36
37
38
39
40
41
42
43
44
45
46
47
48

```

1      color = rank % num_servers;
2
3      /* Split the intercommunicator */
4      MPI_Comm_split ( multiple_server_comm, color, rank,
5                      &single_server_comm );
6

```

The following is the corresponding server code:

```

8      /* Server code */
9      MPI_Comm multiple_client_comm;
10     MPI_Comm single_server_comm;
11     int      rank;
12
13     /* Create intercommunicator with clients and servers:
14        multiple_client_comm */
15     ...
16
17     /* Split the intercommunicator for a single server per group
18        of clients */
19     MPI_Comm_rank ( multiple_client_comm, &rank );
20     MPI_Comm_split ( multiple_client_comm, rank, 0,
21                    &single_server_comm );
22

```

ticket287.

MPI_COMM_SPLIT_TYPE(comm, split_type, key, info, newcomm)

IN	comm	communicator (handle)
IN	split_type	type of processes to be grouped together (integer)
IN	key	control of rank assignment (integer)
IN	info	info argument (handle)
OUT	newcomm	new communicator (handle)

```

33
34 int MPI_Comm_split_type(MPI_Comm comm, int split_type, int key, MPI_Info
35                        info, MPI_Comm *newcomm)
36

```

```

37 MPI_COMM_SPLIT_TYPE(COMM, SPLIT_TYPE, KEY, INFO, NEWCOMM, IERROR)
38     INTEGER COMM, SPLIT_TYPE, KEY, INFO, NEWCOMM, IERROR
39

```

This function partitions the group associated with `comm` into disjoint subgroups, based on the type specified by `split_type`. Each subgroup contains all processes of the same type. Within each subgroup, the processes are ranked in the order defined by the value of the argument `key`, with ties broken according to their rank in the old group. A new communicator is created for each subgroup and returned in `newcomm`. This is a collective call; all processes must provide the same `split_type`, but each process is permitted to provide different values for `key`. An exception to this rule is that a process may supply the type value `MPI_UNDEFINED`, in which case `newcomm` returns `MPI_COMM_NULL`.

The following type is predefined by MPI:

`MPI_COMM_TYPE_SHARED` — this type splits the communicator into subcommunicators, each of which can create a shared memory region.

Advice to implementors. Implementations can define their own types, or use the `info` argument, to assist in creating communicators that help expose platform-specific information to the application. (*End of advice to implementors.*)

6.4.3 Communicator Destructors

`MPI_COMM_FREE(comm)`

INOUT comm communicator to be destroyed (handle)

```
int MPI_Comm_free(MPI_Comm *comm)
```

```
MPI_Comm_free(comm, ierror) BIND(C)
    TYPE(MPI_Comm), INTENT(INOUT) :: comm
    INTEGER, OPTIONAL, INTENT(OUT) :: ierror
```

```
MPI_COMM_FREE(COMM, IERROR)
    INTEGER COMM, IERROR
```

```
{void MPI::Comm::Free() (binding deprecated, see Section 15.2) }
```

This collective operation marks the communication object for deallocation. The handle is set to `MPI_COMM_NULL`. Any pending operations that use this communicator will complete normally; the object is actually deallocated only if there are no other active references to it. This call applies to intra- and inter-communicators. The delete callback functions for all cached attributes (see Section 6.7) are called in arbitrary order.

Advice to implementors. A reference-count mechanism may be used: the reference count is incremented by each call to `MPI_COMM_DUP`, and decremented by each call to `MPI_COMM_FREE`. The object is ultimately deallocated when the count reaches zero.

Though collective, it is anticipated that this operation will normally be implemented to be local, though a debugging version of an MPI library might choose to synchronize. (*End of advice to implementors.*)

6.5 Motivating Examples

6.5.1 Current Practice #1

Example #1a:

```
int main(int argc, char **argv)
{
    int me, size;
    ...
```

```

1     MPI_Init ( &argc, &argv );
2     MPI_Comm_rank (MPI_COMM_WORLD, &me);
3     MPI_Comm_size (MPI_COMM_WORLD, &size);
4
5     (void)printf ("Process %d size %d\n", me, size);
6     ...
7     MPI_Finalize();
8 }

```

ticket182. Example #1a is a do-nothing program that initializes itself [\[legally\]](#), and refers to the “all”
 ticket182. communicator, and prints a message. It terminates itself [\[legally\]](#) too. This example does
 not imply that MPI supports `printf`-like communication itself.

Example #1b (supposing that `size` is even):

```

14     int main(int argc, char **argv)
15     {
16         int me, size;
17         int SOME_TAG = 0;
18         ...
19         MPI_Init(&argc, &argv);
20
21         MPI_Comm_rank(MPI_COMM_WORLD, &me); /* local */
22         MPI_Comm_size(MPI_COMM_WORLD, &size); /* local */
23
24         if((me % 2) == 0)
25         {
26             /* send unless highest-numbered process */
27             if((me + 1) < size)
28                 MPI_Send(..., me + 1, SOME_TAG, MPI_COMM_WORLD);
29         }
30         else
31             MPI_Recv(..., me - 1, SOME_TAG, MPI_COMM_WORLD, &status);
32
33         ...
34         MPI_Finalize();
35     }
36

```

Example #1b schematically illustrates message exchanges between “even” and “odd” processes in the “all” communicator.

6.5.2 Current Practice #2

```

41     int main(int argc, char **argv)
42     {
43         int me, count;
44         void *data;
45         ...
46
47         MPI_Init(&argc, &argv);
48

```

```

MPI_Comm_rank(MPI_COMM_WORLD, &me);
1
2
if(me == 0)
3
{
4
    /* get input, create buffer 'data' */
5
    ...
6
}
7
8
MPI_Bcast(data, count, MPI_BYTE, 0, MPI_COMM_WORLD);
9
10
...
11
12
MPI_Finalize();
13
}
14
15

```

This example illustrates the use of a collective communication.

6.5.3 (Approximate) Current Practice #3

```

int main(int argc, char **argv)
16
{
17
    int me, count, count2;
18
    void *send_buf, *recv_buf, *send_buf2, *recv_buf2;
19
    MPI_Group MPI_GROUP_WORLD, grpem;
20
    MPI_Comm commslave;
21
    static int ranks[] = {0};
22
    ...
23
    MPI_Init(&argc, &argv);
24
    MPI_Comm_group(MPI_COMM_WORLD, &MPI_GROUP_WORLD);
25
    MPI_Comm_rank(MPI_COMM_WORLD, &me); /* local */
26
27
    MPI_Group_excl(MPI_GROUP_WORLD, 1, ranks, &grpem); /* local */
28
    MPI_Comm_create(MPI_COMM_WORLD, grpem, &commslave);
29
30
31
    if(me != 0)
32
    {
33
        /* compute on slave */
34
        ...
35
        MPI_Reduce(send_buf,recv_buf,count, MPI_INT, MPI_SUM, 1, commslave);
36
        ...
37
        MPI_Comm_free(&commslave);
38
    }
39
    /* zero falls through immediately to this reduce, others do later... */
40
    MPI_Reduce(send_buf2, recv_buf2, count2,
41
               MPI_INT, MPI_SUM, 0, MPI_COMM_WORLD);
42
43
    MPI_Group_free(&MPI_GROUP_WORLD);
44
    MPI_Group_free(&grpem);
45
46
47
48

```

```

1     MPI_Finalize();
2     }

```

3
4 This example illustrates how a group consisting of all but the zeroth process of the “all” group is created, and then how a communicator is formed (`commslave`) for that new group. The new communicator is used in a collective call, and all processes execute a collective call in the `MPI_COMM_WORLD` context. This example illustrates how the two communicators (that inherently possess distinct contexts) protect communication. That is, communication in `MPI_COMM_WORLD` is insulated from communication in `commslave`, and vice versa.

5
6
7
8
9 In summary, “group safety” is achieved via communicators because distinct contexts within communicators are enforced to be unique on any process.

12

13 6.5.4 Example #4

14

15 The following example is meant to illustrate “safety” between point-to-point and collective communication. MPI guarantees that a single communicator can do safe point-to-point and collective communication.

16

```

17
18     #define TAG_ARBITRARY 12345
19     #define SOME_COUNT    50
20
21     int main(int argc, char **argv)
22     {
23         int me;
24         MPI_Request request[2];
25         MPI_Status status[2];
26         MPI_Group MPI_GROUP_WORLD, subgroup;
27         int ranks[] = {2, 4, 6, 8};
28         MPI_Comm the_comm;
29         ...
30         MPI_Init(&argc, &argv);
31         MPI_Comm_group(MPI_COMM_WORLD, &MPI_GROUP_WORLD);
32
33         MPI_Group_incl(MPI_GROUP_WORLD, 4, ranks, &subgroup); /* local */
34         MPI_Group_rank(subgroup, &me); /* local */
35
36         MPI_Comm_create(MPI_COMM_WORLD, subgroup, &the_comm);
37
38         if(me != MPI_UNDEFINED)
39         {
40             MPI_Irecv(buff1, count, MPI_DOUBLE, MPI_ANY_SOURCE, TAG_ARBITRARY,
41                     the_comm, request);
42             MPI_Isend(buff2, count, MPI_DOUBLE, (me+1)%4, TAG_ARBITRARY,
43                     the_comm, request+1);
44             for(i = 0; i < SOME_COUNT; i++)
45                 MPI_Reduce(..., the_comm);
46             MPI_Waitall(2, request, status);
47
48             MPI_Comm_free(&the_comm);

```



```

    }
    MPI_Group_free(&MPI_GROUP_WORLD);
    MPI_Group_free(&subgroup);
    MPI_Finalize();
}

```

6.5.5 Library Example #1

The main program:

```

int main(int argc, char **argv)
{
    int done = 0;
    user_lib_t *libh_a, *libh_b;
    void *dataset1, *dataset2;
    ...
    MPI_Init(&argc, &argv);
    ...
    init_user_lib(MPI_COMM_WORLD, &libh_a);
    init_user_lib(MPI_COMM_WORLD, &libh_b);
    ...
    user_start_op(libh_a, dataset1);
    user_start_op(libh_b, dataset2);
    ...
    while(!done)
    {
        /* work */
        ...
        MPI_Reduce(..., MPI_COMM_WORLD);
        ...
        /* see if done */
        ...
    }
    user_end_op(libh_a);
    user_end_op(libh_b);

    uninit_user_lib(libh_a);
    uninit_user_lib(libh_b);
    MPI_Finalize();
}

```

The user library initialization code:

```

void init_user_lib(MPI_Comm comm, user_lib_t **handle)
{
    user_lib_t *save;

    user_lib_initsave(&save); /* local */
}

```

```

1     MPI_Comm_dup(comm, &(save -> comm));
2
3     /* other inits */
4     ...
5
6     *handle = save;
7 }
8
9 User start-up code:
10 void user_start_op(user_lib_t *handle, void *data)
11 {
12     MPI_Irecv( ..., handle->comm, &(handle -> irecv_handle) );
13     MPI_Isend( ..., handle->comm, &(handle -> isend_handle) );
14 }
15
16 User communication clean-up code:
17 void user_end_op(user_lib_t *handle)
18 {
19     MPI_Status status;
20     MPI_Wait(& handle -> isend_handle, &status);
21     MPI_Wait(& handle -> irecv_handle, &status);
22 }
23
24 User object clean-up code:
25 void uninit_user_lib(user_lib_t *handle)
26 {
27     MPI_Comm_free(&(handle -> comm));
28     free(handle);
29 }
30
31

```

32 6.5.6 Library Example #2

33 The main program:

```

34
35 int main(int argc, char **argv)
36 {
37     int ma, mb;
38     MPI_Group MPI_GROUP_WORLD, group_a, group_b;
39     MPI_Comm comm_a, comm_b;
40
41     static int list_a[] = {0, 1};
42     #if defined(EXAMPLE_2B) | defined(EXAMPLE_2C)
43     static int list_b[] = {0, 2 ,3};
44     #else/* EXAMPLE_2A */
45     static int list_b[] = {0, 2};
46     #endif
47     int size_list_a = sizeof(list_a)/sizeof(int);
48     int size_list_b = sizeof(list_b)/sizeof(int);

```

```

1
2
3
4
5
6
7
8
9
10
11
12
13
14
15
16
17
18
19
20
21
22
23
24
25
26
27
28
29
30
31
32
33
34
35

```

```

...
MPI_Init(&argc, &argv);
MPI_Comm_group(MPI_COMM_WORLD, &MPI_GROUP_WORLD);

MPI_Group_incl(MPI_GROUP_WORLD, size_list_a, list_a, &group_a);
MPI_Group_incl(MPI_GROUP_WORLD, size_list_b, list_b, &group_b);

MPI_Comm_create(MPI_COMM_WORLD, group_a, &comm_a);
MPI_Comm_create(MPI_COMM_WORLD, group_b, &comm_b);

if(comm_a != MPI_COMM_NULL)
    MPI_Comm_rank(comm_a, &ma);
if(comm_b != MPI_COMM_NULL)
    MPI_Comm_rank(comm_b, &mb);

if(comm_a != MPI_COMM_NULL)
    lib_call(comm_a);

if(comm_b != MPI_COMM_NULL)
{
    lib_call(comm_b);
    lib_call(comm_b);
}

if(comm_a != MPI_COMM_NULL)
    MPI_Comm_free(&comm_a);
if(comm_b != MPI_COMM_NULL)
    MPI_Comm_free(&comm_b);
MPI_Group_free(&group_a);
MPI_Group_free(&group_b);
MPI_Group_free(&MPI_GROUP_WORLD);
MPI_Finalize();
}

```

The library:

```

36
37
38
39
40
41
42
43
44
45
46
47
48

```

```

void lib_call(MPI_Comm comm)
{
    int me, done = 0;
    MPI_Status status;
    MPI_Comm_rank(comm, &me);
    if(me == 0)
        while(!done)
        {
            MPI_Recv(..., MPI_ANY_SOURCE, MPI_ANY_TAG, comm, &status);
            ...
        }
    else

```

```

1      {
2          /* work */
3          MPI_Send(..., 0, ARBITRARY_TAG, comm);
4          ....
5      }
6  #ifdef EXAMPLE_2C
7      /* include (resp, exclude) for safety (resp, no safety): */
8      MPI_Barrier(comm);
9  #endif
10     }

```

The above example is really three examples, depending on whether or not one includes rank 3 in `list_b`, and whether or not a synchronize is included in `lib_call`. This example illustrates that, despite contexts, subsequent calls to `lib_call` with the same context need not be safe from one another (colloquially, “back-masking”). Safety is realized if the `MPI_Barrier` is added. What this demonstrates is that libraries have to be written carefully, even with contexts. When rank 3 is excluded, then the synchronize is not needed to get safety from back masking.

Algorithms like “reduce” and “allreduce” have strong enough source selectivity properties so that they are inherently okay (no backmasking), provided that MPI provides basic guarantees. So are multiple calls to a typical tree-broadcast algorithm with the same root or different roots (see [58]). Here we rely on two guarantees of MPI: pairwise ordering of messages between processes in the same context, and source selectivity — deleting either feature removes the guarantee that backmasking cannot be required.

Algorithms that try to do non-deterministic broadcasts or other calls that include wildcard operations will not generally have the good properties of the deterministic implementations of “reduce,” “allreduce,” and “broadcast.” Such algorithms would have to utilize the monotonically increasing tags (within a communicator scope) to keep things straight.

All of the foregoing is a supposition of “collective calls” implemented with point-to-point operations. MPI implementations may or may not implement collective calls using point-to-point operations. These algorithms are used to illustrate the issues of correctness and safety, independent of how MPI implements its collective calls. See also Section 6.9.

33

34 6.6 Inter-Communication

35

36 This section introduces the concept of inter-communication and describes the portions of
 37 MPI that support it. It describes support for writing programs that contain user-level
 38 servers.

39 All communication described thus far has involved communication between processes
 40 that are members of the same group. This type of communication is called “intra-commun-
 41 ication” and the communicator used is called an “intra-communicator,” as we have noted
 42 earlier in the chapter.

43 In modular and multi-disciplinary applications, different process groups execute distinct
 44 modules and processes within different modules communicate with one another in a pipeline
 45 or a more general module graph. In these applications, the most natural way for a process
 46 to specify a target process is by the rank of the target process within the target group. In
 47 applications that contain internal user-level servers, each server may be a process group that
 48 provides services to one or more clients, and each client may be a process group that uses

the services of one or more servers. It is again most natural to specify the target process by rank within the target group in these applications. This type of communication is called “inter-communication” and the communicator used is called an “inter-communicator,” as introduced earlier.

An inter-communication is a point-to-point communication between processes in different groups. The group containing a process that initiates an inter-communication operation is called the “local group,” that is, the sender in a send and the receiver in a receive. The group containing the target process is called the “remote group,” that is, the receiver in a send and the sender in a receive. As in intra-communication, the target process is specified using a (communicator, rank) pair. Unlike intra-communication, the rank is relative to a second, remote group.

All inter-communicator constructors are blocking and require that the local and remote groups be disjoint.

Advice to users. The groups must be disjoint for several reasons. Primarily, this is the intent of the intercommunicators — to provide a communicator for communication between disjoint groups. This is reflected in the definition of `MPI_INTERCOMM_MERGE`, which allows the user to control the ranking of the processes in the created intracommunicator; this ranking makes little sense if the groups are not disjoint. In addition, the natural extension of collective operations to inter-communicators makes the most sense when the groups are disjoint. (*End of advice to users.*)

Here is a summary of the properties of inter-communication and inter-communicators:

- The syntax of point-to-point and collective communication is the same for both inter- and intra-communication. The same communicator can be used both for send and for receive operations.
- A target process is addressed by its rank in the remote group, both for sends and for receives.
- Communications using an inter-communicator are guaranteed not to conflict with any communications that use a different communicator.
- A communicator will provide either intra- or inter-communication, never both.

The routine `MPI_COMM_TEST_INTER` may be used to determine if a communicator is an inter- or intra-communicator. Inter-communicators can be used as arguments to some of the other communicator access routines. Inter-communicators cannot be used as input to some of the constructor routines for intra-communicators (for instance, `MPI_CART_CREATE`).

Advice to implementors. For the purpose of point-to-point communication, communicators can be represented in each process by a tuple consisting of:

group

send_context

receive_context

source

For inter-communicators, **group** describes the remote group, and **source** is the rank of the process in the local group. For intra-communicators, **group** is the communicator group (remote=local), **source** is the rank of the process in this group, and **send context** and **receive context** are identical. A group can be represented by a rank-to-absolute-address translation table.

The inter-communicator cannot be discussed sensibly without considering processes in both the local and remote groups. Imagine a process **P** in group \mathcal{P} , which has an inter-communicator $C_{\mathcal{P}}$, and a process **Q** in group \mathcal{Q} , which has an inter-communicator $C_{\mathcal{Q}}$. Then

- $C_{\mathcal{P}}.\mathbf{group}$ describes the group \mathcal{Q} and $C_{\mathcal{Q}}.\mathbf{group}$ describes the group \mathcal{P} .
- $C_{\mathcal{P}}.\mathbf{send_context} = C_{\mathcal{Q}}.\mathbf{receive_context}$ and the context is unique in \mathcal{Q} ;
 $C_{\mathcal{P}}.\mathbf{receive_context} = C_{\mathcal{Q}}.\mathbf{send_context}$ and this context is unique in \mathcal{P} .
- $C_{\mathcal{P}}.\mathbf{source}$ is rank of **P** in \mathcal{P} and $C_{\mathcal{Q}}.\mathbf{source}$ is rank of **Q** in \mathcal{Q} .

Assume that **P** sends a message to **Q** using the inter-communicator. Then **P** uses the **group** table to find the absolute address of **Q**; **source** and **send_context** are appended to the message.

Assume that **Q** posts a receive with an explicit source argument using the inter-communicator. Then **Q** matches **receive_context** to the message context and source argument to the message source.

The same algorithm is appropriate for intra-communicators as well.

In order to support inter-communicator accessors and constructors, it is necessary to supplement this model with additional structures, that store information about the local communication group, and additional safe contexts. (*End of advice to implementors.*)

6.6.1 Inter-communicator Accessors

MPI_COMM_TEST_INTER(comm, flag)

IN	comm	communicator (handle)
OUT	flag	(logical)

```
int MPI_Comm_test_inter(MPI_Comm comm, int *flag)
```

```
MPI_Comm_test_inter(comm, flag, ierror) BIND(C)
    TYPE(MPI_Comm), INTENT(IN) :: comm
    LOGICAL, INTENT(OUT) :: flag
    INTEGER, OPTIONAL, INTENT(OUT) :: ierror
```

```
MPI_COMM_TEST_INTER(COMM, FLAG, IERROR)
    INTEGER COMM, IERROR
    LOGICAL FLAG
```

```
{bool MPI::Comm::Is_inter() const(binding deprecated, see Section 15.2) }
```

ticket-248T.

This local routine allows the calling process to determine if a communicator is an inter-communicator or an intra-communicator. It returns true if it is an inter-communicator, otherwise false.

When an inter-communicator is used as an input argument to the communicator accessors described above under intra-communication, the following table describes behavior.

MPI_COMM_SIZE	returns the size of the local group.
MPI_COMM_GROUP	returns the local group.
MPI_COMM_RANK	returns the rank in the local group

Table 6.1: MPI_COMM_* Function Behavior (in Inter-Communication Mode)

Furthermore, the operation MPI_COMM_COMPARE is valid for inter-communicators. Both communicators must be either intra- or inter-communicators, or else MPI_UNEQUAL results. Both corresponding local and remote groups must compare correctly to get the results MPI_CONGRUENT and MPI_SIMILAR. In particular, it is possible for MPI_SIMILAR to result because either the local or remote groups were similar but not identical.

The following accessors provide consistent access to the remote group of an inter-communicator:

The following are all local operations.

MPI_COMM_REMOTE_SIZE(comm, size)

IN	comm	inter-communicator (handle)
OUT	size	number of processes in the remote group of comm (integer)

```
int MPI_Comm_remote_size(MPI_Comm comm, int *size)
```

```
MPI_Comm_remote_size(comm, size, ierror) BIND(C)
```

```
  TYPE(MPI_Comm), INTENT(IN) :: comm
```

```
  INTEGER, INTENT(OUT) :: size
```

```
  INTEGER, OPTIONAL, INTENT(OUT) :: ierror
```

```
MPI_COMM_REMOTE_SIZE(COMM, SIZE, IERROR)
```

```
  INTEGER COMM, SIZE, IERROR
```

```
{int MPI::Intercomm::Get_remote_size() const(binding deprecated, see Section 15.2)  
  }
```

MPI_COMM_REMOTE_GROUP(comm, group)

IN	comm	inter-communicator (handle)
OUT	group	remote group corresponding to comm (handle)

```
int MPI_Comm_remote_group(MPI_Comm comm, MPI_Group *group)
```

```

1 MPI_Comm_remote_group(comm, group, ierror) BIND(C)
2     TYPE(MPI_Comm), INTENT(IN) :: comm
3     TYPE(MPI_Group), INTENT(OUT) :: group
4     INTEGER, OPTIONAL, INTENT(OUT) :: ierror
5
6 MPI_COMM_REMOTE_GROUP(COMM, GROUP, IERROR)
7     INTEGER COMM, GROUP, IERROR
8
9 {MPI::Group MPI::Intercomm::Get_remote_group() const(binding deprecated, see
10     Section 15.2) }

```

Rationale. Symmetric access to both the local and remote groups of an inter-communicator is important, so this function, as well as MPI_COMM_REMOTE_SIZE have been provided. (*End of rationale.*)

6.6.2 Inter-communicator Operations

This section introduces four blocking inter-communicator operations.

MPI_INTERCOMM_CREATE is used to bind two intra-communicators into an inter-communicator; the function MPI_INTERCOMM_MERGE creates an intra-communicator by merging the local and remote groups of an inter-communicator. The functions MPI_COMM_DUP and MPI_COMM_FREE, introduced previously, duplicate and free an inter-communicator, respectively.

Overlap of local and remote groups that are bound into an inter-communicator is prohibited. If there is overlap, then the program is erroneous and is likely to deadlock. (If a process is multithreaded, and MPI calls block only a thread, rather than a process, then “dual membership” can be supported. It is then the user’s responsibility to make sure that calls on behalf of the two “roles” of a process are executed by two independent threads.)

The function MPI_INTERCOMM_CREATE can be used to create an inter-communicator from two existing intra-communicators, in the following situation: At least one selected member from each group (the “group leader”) has the ability to communicate with the selected member from the other group; that is, a “peer” communicator exists to which both leaders belong, and each leader knows the rank of the other leader in this peer communicator. Furthermore, members of each group know the rank of their leader.

Construction of an inter-communicator from two intra-communicators requires separate collective operations in the local group and in the remote group, as well as a point-to-point communication between a process in the local group and a process in the remote group.

In standard MPI implementations (with static process allocation at initialization), the MPI_COMM_WORLD communicator (or preferably a dedicated duplicate thereof) can be this peer communicator. For applications that have used spawn or join, it may be necessary to first create an intracommunicator to be used as peer.

The application topology functions described in Chapter 7 do not apply to inter-communicators. Users that require this capability should utilize MPI_INTERCOMM_MERGE to build an intra-communicator, then apply the graph or cartesian topology capabilities to that intra-communicator, creating an appropriate topology-oriented intra-communicator. Alternatively, it may be reasonable to devise one’s own application topology mechanisms for this case, without loss of generality.

```
MPI_INTERCOMM_CREATE(local_comm, local_leader, peer_comm, remote_leader, tag,
                      newintercomm)
```

IN	local_comm	local intra-communicator (handle)	1
IN	local_leader	rank of local group leader in local_comm (integer)	2
IN	peer_comm	“peer” communicator; significant only at the local_leader (handle)	3
IN	remote_leader	rank of remote group leader in peer_comm; significant only at the local_leader (integer)	4
IN	tag	“safe” tag (integer)	5
OUT	newintercomm	new inter-communicator (handle)	6

```
int MPI_Intercomm_create(MPI_Comm local_comm, int local_leader,
                        MPI_Comm peer_comm, int remote_leader, int tag,
                        MPI_Comm *newintercomm)
```

```
MPI_Intercomm_create(local_comm, local_leader, peer_comm, remote_leader,
                    tag, newintercomm, ierror) BIND(C)
TYPE(MPI_Comm), INTENT(IN) :: local_comm, peer_comm
INTEGER, INTENT(IN) :: local_leader, remote_leader, tag
TYPE(MPI_Comm), INTENT(OUT) :: newintercomm
INTEGER, OPTIONAL, INTENT(OUT) :: ierror
```

```
MPI_INTERCOMM_CREATE(LOCAL_COMM, LOCAL_LEADER, PEER_COMM, REMOTE_LEADER,
                    TAG, NEWINTERCOMM, IERROR)
INTEGER LOCAL_COMM, LOCAL_LEADER, PEER_COMM, REMOTE_LEADER, TAG,
NEWINTERCOMM, IERROR
```

```
{MPI::Intercomm MPI::Intracomm::Create_intercomm(int local_leader, const
MPI::Comm& peer_comm, int remote_leader, int tag) const(binding
deprecated, see Section 15.2) }
```

This call creates an inter-communicator. It is collective over the union of the local and remote groups. Processes should provide identical local_comm and local_leader arguments within each group. Wildcards are not permitted for remote_leader, local_leader, and tag.

This call uses point-to-point communication with communicator peer_comm, and with tag tag between the leaders. Thus, care must be taken that there be no pending communication on peer_comm that could interfere with this communication.

Advice to users. We recommend using a dedicated peer communicator, such as a duplicate of MPI_COMM_WORLD, to avoid trouble with peer communicators. (*End of advice to users.*)

```

1 MPI_INTERCOMM_MERGE(intercomm, high, newintracomm)
2     IN      intercomm          Inter-Communicator (handle)
3
4     IN      high                (logical)
5
6     OUT     newintracomm        new intra-communicator (handle)

```

```

7 int MPI_Intercomm_merge(MPI_Comm intercomm, int high,
8     MPI_Comm *newintracomm)

```

```

9
10 MPI_Intercomm_merge(intercomm, high, newintracomm, ierror) BIND(C)
11     TYPE(MPI_Comm), INTENT(IN) :: intercomm
12     LOGICAL, INTENT(IN) :: high
13     TYPE(MPI_Comm), INTENT(OUT) :: newintracomm
14     INTEGER, OPTIONAL, INTENT(OUT) :: ierror

```

```

15 MPI_INTERCOMM_MERGE(INTERCOMM, HIGH, NEWINTRACOMM, IERROR)
16     INTEGER INTERCOMM, NEWINTRACOMM, IERROR
17     LOGICAL HIGH

```

```

18
19 {MPI::Intracomm MPI::Intercomm::Merge(bool high) const(binding deprecated, see
20     Section 15.2)}

```

This function creates an intra-communicator from the union of the two groups that are associated with `intercomm`. All processes should provide the same `high` value within each of the two groups. If processes in one group provided the value `high = false` and processes in the other group provided the value `high = true` then the union orders the “low” group before the “high” group. If all processes provided the same `high` argument then the order of the union is arbitrary. This call is blocking and collective within the union of the two groups.

The error handler on the new intercommunicator in each process is inherited from the communicator that contributes the local group. Note that this can result in different processes in the same communicator having different error handlers.

Advice to implementors. The implementation of `MPI_INTERCOMM_MERGE`, `MPI_COMM_FREE` and `MPI_COMM_DUP` are similar to the implementation of `MPI_INTERCOMM_CREATE`, except that contexts private to the input inter-communicator are used for communication between group leaders rather than contexts inside a bridge communicator. (*End of advice to implementors.*)

6.6.3 Inter-Communication Examples

Example 1: Three-Group “Pipeline”

Groups 0 and 1 communicate. Groups 1 and 2 communicate. Therefore, group 0 requires one inter-communicator, group 1 requires two inter-communicators, and group 2 requires 1 inter-communicator.

```

45 int main(int argc, char **argv)
46 {
47     MPI_Comm myComm;          /* intra-communicator of local sub-group */
48     MPI_Comm myFirstComm;    /* inter-communicator */

```

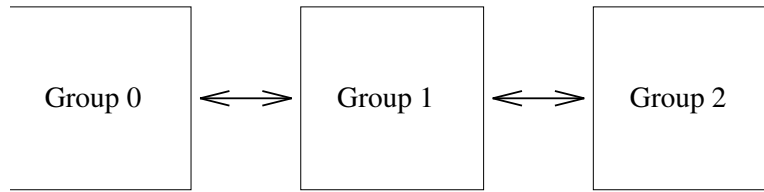

Figure 6.3: Three-group pipeline[ticket0.][.]

```

1
2
3
4
5
6
7
8
9
MPI_Comm  mySecondComm; /* second inter-communicator (group 1 only) */
10
int membershipKey;
11
int rank;
12
13
MPI_Init(&argc, &argv);
14
MPI_Comm_rank(MPI_COMM_WORLD, &rank);
15
16
/* User code must generate membershipKey in the range [0, 1, 2] */
17
membershipKey = rank % 3;
18
19
/* Build intra-communicator for local sub-group */
20
MPI_Comm_split(MPI_COMM_WORLD, membershipKey, rank, &myComm);
21
22
/* Build inter-communicators. Tags are hard-coded. */
23
if (membershipKey == 0)
24
{
25
    /* Group 0 communicates with group 1. */
26
    MPI_Intercomm_create( myComm, 0, MPI_COMM_WORLD, 1,
27
                        1, &myFirstComm);
28
}
29
else if (membershipKey == 1)
30
{
31
    /* Group 1 communicates with groups 0 and 2. */
32
    MPI_Intercomm_create( myComm, 0, MPI_COMM_WORLD, 0,
33
                        1, &myFirstComm);
34
    MPI_Intercomm_create( myComm, 0, MPI_COMM_WORLD, 2,
35
                        12, &mySecondComm);
36
}
37
else if (membershipKey == 2)
38
{
39
    /* Group 2 communicates with group 1. */
40
    MPI_Intercomm_create( myComm, 0, MPI_COMM_WORLD, 1,
41
                        12, &myFirstComm);
42
}
43
44
/* Do work ... */
45
46
switch(membershipKey) /* free communicators appropriately */
47
{
48
    case 1:
49
        MPI_Comm_free(&mySecondComm);
50
    case 0:
51

```

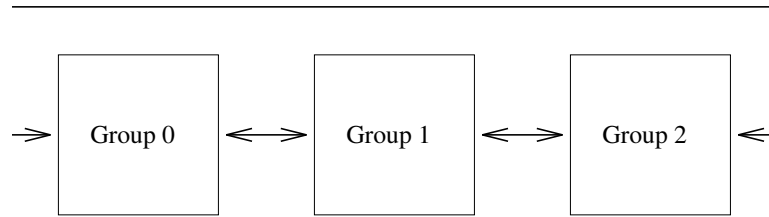

Figure 6.4: Three-group ring[ticket0].[.]

```

10     case 2:
11         MPI_Comm_free(&myFirstComm);
12         break;
13     }
14
15     MPI_Finalize();
16 }

```

Example 2: Three-Group “Ring”

Groups 0 and 1 communicate. Groups 1 and 2 communicate. Groups 0 and 2 communicate. Therefore, each requires two inter-communicators.

```

23 int main(int argc, char **argv)
24 {
25     MPI_Comm  myComm;      /* intra-communicator of local sub-group */
26     MPI_Comm  myFirstComm; /* inter-communicators */
27     MPI_Comm  mySecondComm;
28     MPI_Status status;
29     int membershipKey;
30     int rank;
31
32     MPI_Init(&argc, &argv);
33     MPI_Comm_rank(MPI_COMM_WORLD, &rank);
34     ...
35
36     /* User code must generate membershipKey in the range [0, 1, 2] */
37     membershipKey = rank % 3;
38
39     /* Build intra-communicator for local sub-group */
40     MPI_Comm_split(MPI_COMM_WORLD, membershipKey, rank, &myComm);
41
42     /* Build inter-communicators. Tags are hard-coded. */
43     if (membershipKey == 0)
44     {
45         /* Group 0 communicates with groups 1 and 2. */
46         MPI_Intercomm_create( myComm, 0, MPI_COMM_WORLD, 1,
47                               1, &myFirstComm);
48         MPI_Intercomm_create( myComm, 0, MPI_COMM_WORLD, 2,
49                               2, &mySecondComm);

```

```

}
else if (membershipKey == 1)
{
    /* Group 1 communicates with groups 0 and 2. */
    MPI_Intercomm_create( myComm, 0, MPI_COMM_WORLD, 0,
                          1, &myFirstComm);
    MPI_Intercomm_create( myComm, 0, MPI_COMM_WORLD, 2,
                          12, &mySecondComm);
}
else if (membershipKey == 2)
{
    /* Group 2 communicates with groups 0 and 1. */
    MPI_Intercomm_create( myComm, 0, MPI_COMM_WORLD, 0,
                          2, &myFirstComm);
    MPI_Intercomm_create( myComm, 0, MPI_COMM_WORLD, 1,
                          12, &mySecondComm);
}

/* Do some work ... */

/* Then free communicators before terminating... */
MPI_Comm_free(&myFirstComm);
MPI_Comm_free(&mySecondComm);
MPI_Comm_free(&myComm);
MPI_Finalize();
}

```

6.7 Caching

MPI provides a “caching” facility that allows an application to attach arbitrary pieces of information, called **attributes**, to three kinds of MPI objects, communicators, windows and datatypes. More precisely, the caching facility allows a portable library to do the following:

- pass information between calls by associating it with an MPI intra- or inter-communicator, window or datatype,
- quickly retrieve that information, and
- be guaranteed that out-of-date information is never retrieved, even if the object is freed and its handle subsequently reused by MPI.

The caching capabilities, in some form, are required by built-in MPI routines such as collective communication and application topology. Defining an interface to these capabilities as part of the MPI standard is valuable because it permits routines like collective communication and application topologies to be implemented as portable code, and also because it makes MPI more extensible by allowing user-written routines to use standard MPI calling sequences.

Advice to users. The communicator `MPI_COMM_SELF` is a suitable choice for posting process-local attributes, via this attributing-caching mechanism. (*End of advice to users.*)

1 *Rationale.* In one extreme one can allow caching on all opaque handles. The other
 2 extreme is to only allow it on communicators. Caching has a cost associated with it
 3 and should only be allowed when it is clearly needed and the increased cost is modest.
 4 This is the reason that windows and datatypes were added but not other handles.
 5 (*End of rationale.*)

6
 7 One difficulty is the potential for size differences between Fortran integers and C point-
 8 ers. To overcome this problem with attribute caching on communicators, functions are also
 9 given for this case. The functions to cache on datatypes and windows also address this
 10 issue. For a general discussion of the address size problem, see Section 16.3.6.

11 *Advice to implementors.* High-quality implementations should raise an error when
 12 a keyval that was created by a call to `MPI_XXX_CREATE_KEYVAL` is used with an
 13 object of the wrong type with a call to `MPI_YYY_GET_ATTR`, `MPI_YYY_SET_ATTR`,
 14 `MPI_YYY_DELETE_ATTR`, or `MPI_YYY_FREE_KEYVAL`. To do so, it is necessary to
 15 maintain, with each keyval, information on the type of the associated user function.
 16 (*End of advice to implementors.*)

17 18 6.7.1 Functionality

19
 20 Attributes can be attached to communicators, windows, and datatypes. Attributes are local
 21 to the process and specific to the communicator to which they are attached. Attributes are
 22 not propagated by MPI from one communicator to another except when the communicator
 23 is duplicated using `MPI_COMM_DUP` (and even then the application must give specific
 24 permission through callback functions for the attribute to be copied).

25
 26 *Advice to users.* Attributes in C are of type `void *`. Typically, such an attribute will
 27 be a pointer to a structure that contains further information, or a handle to an MPI
 28 object. In Fortran, attributes are of type `INTEGER`. Such attribute can be a handle to
 29 an MPI object, or just an integer-valued attribute. (*End of advice to users.*)

30
 31 *Advice to implementors.* Attributes are scalar values, equal in size to, or larger than
 32 a C-language pointer. Attributes can always hold an MPI handle. (*End of advice to
 33 implementors.*)

34 The caching interface defined here requires that attributes be stored by MPI opaquely
 35 within a communicator, window, and datatype. Accessor functions include the following:

- 36 • obtain a key value (used to identify an attribute); the user specifies “callback” func-
 37 tions by which MPI informs the application when the communicator is destroyed or
 38 copied.
- 39 • store and retrieve the value of an attribute;

40
 41
 42 *Advice to implementors.* Caching and callback functions are only called synchronously,
 43 in response to explicit application requests. This avoid problems that result from re-
 44 peated crossings between user and system space. (This synchronous calling rule is a
 45 general property of MPI.)

46 The choice of key values is under control of MPI. This allows MPI to optimize its
 47 implementation of attribute sets. It also avoids conflict between independent modules
 48 caching information on the same communicators.

A much smaller interface, consisting of just a callback facility, would allow the entire caching facility to be implemented by portable code. However, with the minimal callback interface, some form of table searching is implied by the need to handle arbitrary communicators. In contrast, the more complete interface defined here permits rapid access to attributes through the use of pointers in communicators (to find the attribute table) and cleverly chosen key values (to retrieve individual attributes). In light of the efficiency “hit” inherent in the minimal interface, the more complete interface defined here is seen to be superior. (*End of advice to implementors.*)

MPI provides the following services related to caching. They are all process local.

6.7.2 Communicators

Functions for caching on communicators are:

```
MPI_COMM_CREATE_KEYVAL(comm_copy_attr_fn, comm_delete_attr_fn, comm_keyval,
                        extra_state)
```

IN	comm_copy_attr_fn	copy callback function for comm_keyval (function)
IN	comm_delete_attr_fn	delete callback function for comm_keyval (function)
OUT	comm_keyval	key value for future access (integer)
IN	extra_state	extra state for callback functions

```
int MPI_Comm_create_keyval(MPI_Comm_copy_attr_function *comm_copy_attr_fn,
                          MPI_Comm_delete_attr_function *comm_delete_attr_fn,
                          int *comm_keyval, void *extra_state)
```

```
MPI_Comm_create_keyval(comm_copy_attr_fn, comm_delete_attr_fn, comm_keyval,
                      extra_state, ierror) BIND(C)
```

```
PROCEDURE(MPI_Comm_copy_attr_function) :: comm_copy_attr_fn
PROCEDURE(MPI_Comm_delete_attr_function) :: comm_delete_attr_fn
INTEGER, INTENT(OUT) :: comm_keyval
INTEGER(KIND=MPI_ADDRESS_KIND), INTENT(IN) :: extra_state
INTEGER, OPTIONAL, INTENT(OUT) :: ierror
```

```
MPI_COMM_CREATE_KEYVAL(COMM_COPY_ATTR_FN, COMM_DELETE_ATTR_FN, COMM_KEYVAL,
                      EXTRA_STATE, IERROR)
```

```
EXTERNAL COMM_COPY_ATTR_FN, COMM_DELETE_ATTR_FN
INTEGER COMM_KEYVAL, IERROR
INTEGER(KIND=MPI_ADDRESS_KIND) EXTRA_STATE
```

```
{static int MPI::Comm::Create_keyval(MPI::Comm::Copy_attr_function*
    comm_copy_attr_fn,
    MPI::Comm::Delete_attr_function* comm_delete_attr_fn,
    void* extra_state) (binding deprecated, see Section 15.2) }
```

Generates a new attribute key. Keys are locally unique in a process, and opaque to user, though they are explicitly stored in integers. Once allocated, the key value can be used to associate attributes and access them on any locally defined communicator.

1 This function replaces MPI_KEYVAL_CREATE, whose use is deprecated. The C binding
 2 is identical. The Fortran binding differs in that extra_state is an address-sized integer.
 3 Also, the copy and delete callback functions have Fortran bindings that are consistent with
 4 address-sized attributes.

5 The C callback functions are:

```
6
7 typedef int MPI_Comm_copy_attr_function(MPI_Comm oldcomm, int comm_keyval,
8     void *extra_state, void *attribute_val_in,
9     void *attribute_val_out, int *flag);
```

10 and

```
11 typedef int MPI_Comm_delete_attr_function(MPI_Comm comm, int comm_keyval,
12     void *attribute_val, void *extra_state);
```

13 which are the same as the MPI-1.1 calls but with a new name. The old names are deprecated.

14 With the mpi_f08 module, the Fortran callback functions are:

15 **ABSTRACT INTERFACE**

```
16 SUBROUTINE MPI_Comm_copy_attr_function(oldcomm, comm_keyval, extra_state,
17     attribute_val_in, attribute_val_out, flag, ierror) BIND(C)
```

```
18     TYPE(MPI_Comm) :: oldcomm
```

```
19     INTEGER :: comm_keyval, ierror
```

```
20     INTEGER(KIND=MPI_ADDRESS_KIND) :: extra_state, attribute_val_in,
21     attribute_val_out
```

```
22     LOGICAL :: flag
```

23 and

24 **ABSTRACT INTERFACE**

```
25 SUBROUTINE MPI_Comm_delete_attr_function(comm, comm_keyval,
26     attribute_val, extra_state, ierror) BIND(C)
```

```
27     TYPE(MPI_Comm) :: comm
```

```
28     INTEGER :: comm_keyval, ierror
```

```
29     INTEGER(KIND=MPI_ADDRESS_KIND) :: attribute_val, extra_state
```

30 [The]With the mpi module and mpif.h, the Fortran callback functions are:

```
31 SUBROUTINE COMM_COPY_ATTR_[FN]FUNCTION(OLDCOMM, COMM_KEYVAL, EXTRA_STATE,
32     ATTRIBUTE_VAL_IN, ATTRIBUTE_VAL_OUT, FLAG, IERROR)
```

```
33     INTEGER OLDCOMM, COMM_KEYVAL, IERROR
```

```
34     INTEGER(KIND=MPI_ADDRESS_KIND) EXTRA_STATE, ATTRIBUTE_VAL_IN,
35     ATTRIBUTE_VAL_OUT
```

```
36     LOGICAL FLAG
```

37 and

```
38 SUBROUTINE COMM_DELETE_ATTR_[FN]FUNCTION(COMM, COMM_KEYVAL, ATTRIBUTE_VAL,
39     EXTRA_STATE, IERROR)
```

```
40     INTEGER COMM, COMM_KEYVAL, IERROR
```

```
41     INTEGER(KIND=MPI_ADDRESS_KIND) ATTRIBUTE_VAL, EXTRA_STATE
```

42 The C++ callbacks are:

```
{typedef int MPI::Comm::Copy_attr_function(const MPI::Comm& oldcomm,
      int comm_keyval, void* extra_state, void* attribute_val_in,
      void* attribute_val_out, bool& flag); (binding deprecated, see
      Section 15.2)}
```

and

```
{typedef int MPI::Comm::Delete_attr_function(MPI::Comm& comm,
      int comm_keyval, void* attribute_val, void* extra_state);
      (binding deprecated, see Section 15.2)}
```

The `comm_copy_attr_fn` function is invoked when a communicator is duplicated by `MPI_COMM_DUP`. `comm_copy_attr_fn` should be of type `MPI_Comm_copy_attr_function`. The copy callback function is invoked for each key value in `oldcomm` in arbitrary order. Each call to the copy callback is made with a key value and its corresponding attribute. If it returns `flag = 0` or `.FALSE.`, then the attribute is deleted in the duplicated communicator. Otherwise (`flag = 1` or `.TRUE.`), the new attribute value is set to the value returned in `attribute_val_out`. The function returns `MPI_SUCCESS` on success and an error code on failure (in which case `MPI_COMM_DUP` will fail).

The argument `comm_copy_attr_fn` may be specified as `MPI_COMM_NULL_COPY_FN` or `MPI_COMM_DUP_FN` from either C, C++, or Fortran. `MPI_COMM_NULL_COPY_FN` is a function that does nothing other than returning `flag = 0` or `.FALSE.` (depending on whether the keyval was created with a C/C++ or Fortran binding to `MPI_COMM_CREATE_KEYVAL`) and `MPI_SUCCESS`. `MPI_COMM_DUP_FN` is a simple-minded copy function that sets `flag = 1` or `.TRUE.`, returns the value of `attribute_val_in` in `attribute_val_out`, and returns `MPI_SUCCESS`. These replace the MPI-1 predefined callbacks `MPI_NULL_COPY_FN` and `MPI_DUP_FN`, whose use is deprecated.

Advice to users. Even though both formal arguments `attribute_val_in` and `attribute_val_out` are of type `void *`, their usage differs. The C copy function is passed by MPI in `attribute_val_in` the *value* of the attribute, and in `attribute_val_out` the *address* of the attribute, so as to allow the function to return the (new) attribute value. The use of type `void *` for both is to avoid messy type casts.

A valid copy function is one that completely duplicates the information by making a full duplicate copy of the data structures implied by an attribute; another might just make another reference to that data structure, while using a reference-count mechanism. Other types of attributes might not copy at all (they might be specific to `oldcomm` only). (*End of advice to users.*)

Advice to implementors. A C interface should be assumed for copy and delete functions associated with key values created in C; a Fortran calling interface should be assumed for key values created in Fortran. (*End of advice to implementors.*)

Analogous to `comm_copy_attr_fn` is a callback deletion function, defined as follows. The `comm_delete_attr_fn` function is invoked when a communicator is deleted by `MPI_COMM_FREE` or when a call is made explicitly to `MPI_COMM_DELETE_ATTR`. `comm_delete_attr_fn` should be of type `MPI_Comm_delete_attr_function`.

This function is called by `MPI_COMM_FREE`, `MPI_COMM_DELETE_ATTR`, and `MPI_COMM_SET_ATTR` to do whatever is needed to remove an attribute. The function

1 returns MPI_SUCCESS on success and an error code on failure (in which case
2 MPI_COMM_FREE will fail).

3 The argument `comm_delete_attr_fn` may be specified as `MPI_COMM_NULL_DELETE_FN`
4 from either C, C++, or Fortran. `MPI_COMM_NULL_DELETE_FN` is a function that
5 does nothing, other than returning `MPI_SUCCESS`. `MPI_COMM_NULL_DELETE_FN` re-
6 places `MPI_NULL_DELETE_FN`, whose use is deprecated.

7 If an attribute copy function or attribute delete function returns other than
8 `MPI_SUCCESS`, then the call that caused it to be invoked (for example, `MPI_COMM_FREE`),
9 is erroneous.

10 The special key value `MPI_KEYVAL_INVALID` is never returned by
11 `MPI_KEYVAL_CREATE`. Therefore, it can be used for static initialization of key values.

12 *Advice to implementors.* To be able to use the predefined C functions
13 `MPI_COMM_NULL_COPY_FN` or `MPI_COMM_DUP_FN` as `comm_copy_attr_fn` argu-
14 ment and/or `MPI_COMM_NULL_DELETE_FN` as the `comm_delete_attr_fn` argument
15 in a call to the C++ routine `MPI::Comm::Create_keyval`, this routine may be over-
16 loaded with 3 additional routines that accept the C functions as the first, the second,
17 or both input arguments (instead of an argument that matches the C++ prototype).
18 (*End of advice to implementors.*)

19 *Advice to users.* If a user wants to write a “wrapper” routine that internally calls
20 `MPI::Comm::Create_keyval` and `comm_copy_attr_fn` and/or `comm_delete_attr_fn` are
21 arguments of this wrapper routine, and if this wrapper routine should be callable with
22 both user-defined C++ copy and delete functions and with the predefined C functions,
23 then the same overloading as described above in the advice to implementors may be
24 necessary. (*End of advice to users.*)

25 ticket230-B.
26 *Advice to implementors.* The predefined Fortran functions
27 `MPI_COMM_NULL_COPY_FN`, `MPI_COMM_DUP_FN`, and
28 `MPI_COMM_NULL_DELETE_FN` are defined in the `mpi` module (and `mpif.h`) and
29 the `mpi_f08` module with the same name, but with different interfaces. Each function
30 can coexist twice with the same name in the same MPI library, one routine as an
31 implicit interface outside of the `mpi` module, i.e., declared as `EXTERNAL`, and the other
32 routine within `mpi_f08` declared with `CONTAINS`. These routines have different link
33 names, which are also different to the link names used for the routines used in C and
34 C++. (*End of advice to implementors.*)

35 *Advice to users.* Callbacks, including the predefined Fortran functions
36 `MPI_COMM_NULL_COPY_FN`, `MPI_COMM_DUP_FN`, and
37 `MPI_COMM_NULL_DELETE_FN` should not be passed from one application routine
38 that uses the `mpi_f08` module to another application routine that uses the `mpi` module
39 or `mpif.h`, and vice versa, see also the advice to users on page 705. (*End of advice to*
40 *users.*)

41
42
43
44 `MPI_COMM_FREE_KEYVAL(comm_keyval)`

45 INOUT `comm_keyval` key value (integer)

46
47
48 `int MPI_Comm_free_keyval(int *comm_keyval)`

```

MPI_Comm_free_keyval(comm_keyval, ierror) BIND(C)
    INTEGER, INTENT(INOUT) :: comm_keyval
    INTEGER, OPTIONAL, INTENT(OUT) :: ierror

```

```

MPI_COMM_FREE_KEYVAL(COMM_KEYVAL, IERROR)
    INTEGER COMM_KEYVAL, IERROR

```

```

{static void MPI::Comm::Free_keyval(int& comm_keyval) (binding deprecated, see
    Section 15.2) }

```

Frees an extant attribute key. This function sets the value of `keyval` to `MPI_KEYVAL_INVALID`. Note that it is not erroneous to free an attribute key that is in use, because the actual free does not transpire until after all references (in other communicators on the process) to the key have been freed. These references need to be explicitly freed by the program, either via calls to `MPI_COMM_DELETE_ATTR` that free one attribute instance, or by calls to `MPI_COMM_FREE` that free all attribute instances associated with the freed communicator.

This call is identical to the MPI-1 call `MPI_KEYVAL_FREE` but is needed to match the new communicator-specific creation function. The use of `MPI_KEYVAL_FREE` is deprecated.

```

MPI_COMM_SET_ATTR(comm, comm_keyval, attribute_val)

```

INOUT	comm	communicator from which attribute will be attached (handle)
IN	comm_keyval	key value (integer)
IN	attribute_val	attribute value

```

int MPI_Comm_set_attr(MPI_Comm comm, int comm_keyval, void *attribute_val)

```

```

MPI_Comm_set_attr(comm, comm_keyval, attribute_val, ierror) BIND(C)
    TYPE(MPI_Comm), INTENT(IN) :: comm
    INTEGER, INTENT(IN) :: comm_keyval
    INTEGER(KIND=MPI_ADDRESS_KIND), INTENT(IN) :: attribute_val
    INTEGER, OPTIONAL, INTENT(OUT) :: ierror

```

```

MPI_COMM_SET_ATTR(COMM, COMM_KEYVAL, ATTRIBUTE_VAL, IERROR)
    INTEGER COMM, COMM_KEYVAL, IERROR
    INTEGER(KIND=MPI_ADDRESS_KIND) ATTRIBUTE_VAL

```

```

{void MPI::Comm::Set_attr(int comm_keyval, const void* attribute_val)
    const (binding deprecated, see Section 15.2) }

```

This function stores the stipulated attribute value `attribute_val` for subsequent retrieval by `MPI_COMM_GET_ATTR`. If the value is already present, then the outcome is as if `MPI_COMM_DELETE_ATTR` was first called to delete the previous value (and the callback function `comm_delete_attr_fn` was executed), and a new value was next stored. The call is erroneous if there is no key with value `keyval`; in particular `MPI_KEYVAL_INVALID` is an erroneous key value. The call will fail if the `comm_delete_attr_fn` function returned an error code other than `MPI_SUCCESS`.

This function replaces MPI_ATTR_PUT, whose use is deprecated. The C binding is identical. The Fortran binding differs in that `attribute_val` is an address-sized integer.

MPI_COMM_GET_ATTR(comm, comm_keyval, attribute_val, flag)

IN	comm	communicator to which the attribute is attached (handle)
IN	comm_keyval	key value (integer)
OUT	attribute_val	attribute value, unless flag = false
OUT	flag	false if no attribute is associated with the key (logical)

```
int MPI_Comm_get_attr(MPI_Comm comm, int comm_keyval, void *attribute_val,
                    int *flag)
```

```
MPI_Comm_get_attr(comm, comm_keyval, attribute_val, flag, ierror) BIND(C)
  TYPE(MPI_Comm), INTENT(IN) :: comm
  INTEGER, INTENT(IN) :: comm_keyval
  INTEGER(KIND=MPI_ADDRESS_KIND), INTENT(OUT) :: attribute_val
  LOGICAL, INTENT(OUT) :: flag
  INTEGER, OPTIONAL, INTENT(OUT) :: ierror
```

```
MPI_COMM_GET_ATTR(COMM, COMM_KEYVAL, ATTRIBUTE_VAL, FLAG, IERROR)
  INTEGER COMM, COMM_KEYVAL, IERROR
  INTEGER(KIND=MPI_ADDRESS_KIND) ATTRIBUTE_VAL
  LOGICAL FLAG
```

```
{bool MPI::Comm::Get_attr(int comm_keyval, void* attribute_val)
  const(binding deprecated, see Section 15.2) }
```

Retrieves attribute value by key. The call is erroneous if there is no key with value `keyval`. On the other hand, the call is correct if the key value exists, but no attribute is attached on `comm` for that key; in such case, the call returns `flag = false`. In particular `MPI_KEYVAL_INVALID` is an erroneous key value.

Advice to users. The call to `MPI_Comm_set_attr` passes in `attribute_val` the *value* of the attribute; the call to `MPI_Comm_get_attr` passes in `attribute_val` the *address* of the location where the attribute value is to be returned. Thus, if the attribute value itself is a pointer of type `void*`, then the actual `attribute_val` parameter to `MPI_Comm_set_attr` will be of type `void*` and the actual `attribute_val` parameter to `MPI_Comm_get_attr` will be of type `void**`. (*End of advice to users.*)

Rationale. The use of a formal parameter `attribute_val` or type `void*` (rather than `void**`) avoids the messy type casting that would be needed if the attribute value is declared with a type other than `void*`. (*End of rationale.*)

This function replaces MPI_ATTR_GET, whose use is deprecated. The C binding is identical. The Fortran binding differs in that `attribute_val` is an address-sized integer.

```

MPI_COMM_DELETE_ATTR(comm, comm_keyval)
    INOUT    comm                communicator from which the attribute is deleted (handle)
    IN       comm_keyval         key value (integer)

```

```
int MPI_Comm_delete_attr(MPI_Comm comm, int comm_keyval)
```

```

MPI_Comm_delete_attr(comm, comm_keyval, ierror) BIND(C)
    TYPE(MPI_Comm), INTENT(IN) :: comm
    INTEGER, INTENT(IN) :: comm_keyval
    INTEGER, OPTIONAL, INTENT(OUT) :: ierror

```

```

MPI_COMM_DELETE_ATTR(COMM, COMM_KEYVAL, IERROR)
    INTEGER COMM, COMM_KEYVAL, IERROR

```

```

{void MPI::Comm::Delete_attr(int comm_keyval) (binding deprecated, see
    Section 15.2) }

```

Delete attribute from cache by key. This function invokes the attribute delete function `comm_delete_attr_fn` specified when the keyval was created. The call will fail if the `comm_delete_attr_fn` function returns an error code other than `MPI_SUCCESS`.

Whenever a communicator is replicated using the function `MPI_COMM_DUP`, all callback copy functions for attributes that are currently set are invoked (in arbitrary order). Whenever a communicator is deleted using the function `MPI_COMM_FREE` all callback delete functions for attributes that are currently set are invoked.

This function is the same as `MPI_ATTR_DELETE` but is needed to match the new communicator specific functions. The use of `MPI_ATTR_DELETE` is deprecated.

6.7.3 Windows

The new functions for caching on windows are:

```
MPI_WIN_CREATE_KEYVAL(win_copy_attr_fn, win_delete_attr_fn, win_keyval, extra_state)
```

```

    IN       win_copy_attr_fn     copy callback function for win_keyval (function)
    IN       win_delete_attr_fn   delete callback function for win_keyval (function)
    OUT      win_keyval           key value for future access (integer)
    IN       extra_state          extra state for callback functions

```

```

int MPI_Win_create_keyval(MPI_Win_copy_attr_function *win_copy_attr_fn,
    MPI_Win_delete_attr_function *win_delete_attr_fn,
    int *win_keyval, void *extra_state)

```

```

MPI_Win_create_keyval(win_copy_attr_fn, win_delete_attr_fn, win_keyval,
    extra_state, ierror) BIND(C)
    PROCEDURE(MPI_Win_copy_attr_function) :: win_copy_attr_fn
    PROCEDURE(MPI_Win_delete_attr_function) :: win_delete_attr_fn

```

```

1     INTEGER, INTENT(OUT) :: win_keyval
2     INTEGER(KIND=MPI_ADDRESS_KIND), INTENT(IN) :: extra_state
3     INTEGER, OPTIONAL, INTENT(OUT) :: ierror
4
5     MPI_WIN_CREATE_KEYVAL(WIN_COPY_ATTR_FN, WIN_DELETE_ATTR_FN, WIN_KEYVAL,
6                           EXTRA_STATE, IERROR)
7     EXTERNAL WIN_COPY_ATTR_FN, WIN_DELETE_ATTR_FN
8     INTEGER WIN_KEYVAL, IERROR
9     INTEGER(KIND=MPI_ADDRESS_KIND) EXTRA_STATE
10    {static int MPI::Win::Create_keyval(MPI::Win::Copy_attr_function*
11                                       win_copy_attr_fn,
12                                       MPI::Win::Delete_attr_function* win_delete_attr_fn,
13                                       void* extra_state) (binding deprecated, see Section 15.2) }
14

```

15 The argument `win_copy_attr_fn` may be specified as `MPI_WIN_NULL_COPY_FN` or
16 `MPI_WIN_DUP_FN` from either C, C++, or Fortran. `MPI_WIN_NULL_COPY_FN` is a
17 function that does nothing other than returning `flag = 0` and `MPI_SUCCESS`.
18 `MPI_WIN_DUP_FN` is a simple-minded copy function that sets `flag = 1`, returns the value
19 of `attribute_val_in` in `attribute_val_out`, and returns `MPI_SUCCESS`.

20 The argument `win_delete_attr_fn` may be specified as `MPI_WIN_NULL_DELETE_FN`
21 from either C, C++, or Fortran. `MPI_WIN_NULL_DELETE_FN` is a function that does
22 nothing, other than returning `MPI_SUCCESS`.

23 The C callback functions are:

```

24 typedef int MPI_Win_copy_attr_function(MPI_Win oldwin, int win_keyval,
25                                       void *extra_state, void *attribute_val_in,
26                                       void *attribute_val_out, int *flag);
27

```

28 and

```

29 typedef int MPI_Win_delete_attr_function(MPI_Win win, int win_keyval,
30                                       void *attribute_val, void *extra_state);
31

```

ticket230-B. 32 With the `mpi_f08` module, the Fortran callback functions are:

```

ticket-248T. 33 ABSTRACT INTERFACE
34     SUBROUTINE MPI_Win_copy_attr_function(oldwin, win_keyval, extra_state,
35     attribute_val_in, attribute_val_out, flag, ierror) BIND(C)
36     TYPE(MPI_Win) :: oldwin
37     INTEGER :: win_keyval, ierror
38     INTEGER(KIND=MPI_ADDRESS_KIND) :: extra_state, attribute_val_in,
39     attribute_val_out
40     LOGICAL :: flag
41

```

ticket230-B. 42 and

```

ticket-248T. 43 ABSTRACT INTERFACE
44     SUBROUTINE MPI_Win_delete_attr_function(win, win_keyval, attribute_val,
45     extra_state, ierror) BIND(C)
46     TYPE(MPI_Win) :: win
47     INTEGER :: win_keyval, ierror
48     INTEGER(KIND=MPI_ADDRESS_KIND) :: attribute_val, extra_state

```

[The]With the `mpi` module and `mpif.h`, the Fortran callback functions are:

```
SUBROUTINE WIN_COPY_ATTR_[FN]FUNCTION(OLDWIN, WIN_KEYVAL, EXTRA_STATE,
    ATTRIBUTE_VAL_IN, ATTRIBUTE_VAL_OUT, FLAG, IERROR)
    INTEGER OLDWIN, WIN_KEYVAL, IERROR
    INTEGER(KIND=MPI_ADDRESS_KIND) EXTRA_STATE, ATTRIBUTE_VAL_IN,
    ATTRIBUTE_VAL_OUT
    LOGICAL FLAG
```

and

```
SUBROUTINE WIN_DELETE_ATTR_[FN]FUNCTION(WIN, WIN_KEYVAL, ATTRIBUTE_VAL,
    EXTRA_STATE, IERROR)
    INTEGER WIN, WIN_KEYVAL, IERROR
    INTEGER(KIND=MPI_ADDRESS_KIND) ATTRIBUTE_VAL, EXTRA_STATE
```

The C++ callbacks are:

```
{typedef int MPI::Win::Copy_attr_function(const MPI::Win& oldwin,
    int win_keyval, void* extra_state, void* attribute_val_in,
    void* attribute_val_out, bool& flag); (binding deprecated, see
    Section 15.2)}
```

and

```
{typedef int MPI::Win::Delete_attr_function(MPI::Win& win, int win_keyval,
    void* attribute_val, void* extra_state); (binding deprecated, see
    Section 15.2)}
```

If an attribute copy function or attribute delete function returns other than `MPI_SUCCESS`, then the call that caused it to be invoked (for example, `MPI_WIN_FREE`), is erroneous.

`MPI_WIN_FREE_KEYVAL(win_keyval)`

INOUT win_keyval key value (integer)

```
int MPI_Win_free_keyval(int *win_keyval)
```

```
MPI_Win_free_keyval(win_keyval, ierror) BIND(C)
    INTEGER, INTENT(INOUT) :: win_keyval
    INTEGER, OPTIONAL, INTENT(OUT) :: ierror
```

```
MPI_WIN_FREE_KEYVAL(WIN_KEYVAL, IERROR)
    INTEGER WIN_KEYVAL, IERROR
```

```
{static void MPI::Win::Free_keyval(int& win_keyval) (binding deprecated, see
    Section 15.2) }
```

1 ticket230-B.

2 ticket250-V.

3

4

5

6

7

8

9

10 ticket250-V.

11

12

13

14

15

16

17

18

19

20

21

22

23

24

25

26

27

28

29

30

31

32

33

34

35 ticket-248T.

36

37

38

39

40

41

42

43

44

45

46

47

48

```

1 MPI_WIN_SET_ATTR(win, win_keyval, attribute_val)
2     INOUT    win                window to which attribute will be attached (handle)
3
4     IN      win_keyval         key value (integer)
5
6     IN      attribute_val      attribute value

```

```

7 int MPI_Win_set_attr(MPI_Win win, int win_keyval, void *attribute_val)

```

```

8
9 MPI_Win_set_attr(win, win_keyval, attribute_val, ierror) BIND(C)
10     TYPE(MPI_Win), INTENT(IN) :: win
11     INTEGER, INTENT(IN) :: win_keyval
12     INTEGER(KIND=MPI_ADDRESS_KIND), INTENT(IN) :: attribute_val
13     INTEGER, OPTIONAL, INTENT(OUT) :: ierror

```

```

14 MPI_WIN_SET_ATTR(WIN, WIN_KEYVAL, ATTRIBUTE_VAL, IERROR)
15     INTEGER WIN, WIN_KEYVAL, IERROR
16     INTEGER(KIND=MPI_ADDRESS_KIND) ATTRIBUTE_VAL

```

```

17
18 {void MPI::Win::Set_attr(int win_keyval, const void* attribute_val) (binding
19     deprecated, see Section 15.2 ) }

```

```

22 MPI_WIN_GET_ATTR(win, win_keyval, attribute_val, flag)

```

```

23     IN      win                window to which the attribute is attached (handle)
24
25     IN      win_keyval         key value (integer)
26
27     OUT    attribute_val      attribute value, unless flag = false
28
29     OUT    flag                false if no attribute is associated with the key (logical)

```

```

30 int MPI_Win_get_attr(MPI_Win win, int win_keyval, void *attribute_val,
31     int *flag)

```

```

32 MPI_Win_get_attr(win, win_keyval, attribute_val, flag, ierror) BIND(C)
33     TYPE(MPI_Win), INTENT(IN) :: win
34     INTEGER, INTENT(IN) :: win_keyval
35     INTEGER(KIND=MPI_ADDRESS_KIND), INTENT(OUT) :: attribute_val
36     LOGICAL, INTENT(OUT) :: flag
37     INTEGER, OPTIONAL, INTENT(OUT) :: ierror

```

```

38
39 MPI_WIN_GET_ATTR(WIN, WIN_KEYVAL, ATTRIBUTE_VAL, FLAG, IERROR)
40     INTEGER WIN, WIN_KEYVAL, IERROR
41     INTEGER(KIND=MPI_ADDRESS_KIND) ATTRIBUTE_VAL
42     LOGICAL FLAG

```

```

43 {bool MPI::Win::Get_attr(int win_keyval, void* attribute_val) const (binding
44     deprecated, see Section 15.2 ) }

```



```

MPI_WIN_DELETE_ATTR(win, win_keyval) 1
    INOUT win window from which the attribute is deleted (handle) 2
    IN win_keyval key value (integer) 3
                                        4
                                        5
int MPI_Win_delete_attr(MPI_Win win, int win_keyval) 6
MPI_Win_delete_attr(win, win_keyval, ierror) BIND(C) 7 ticket-248T.
    TYPE(MPI_Win), INTENT(IN) :: win 8
    INTEGER, INTENT(IN) :: win_keyval 9
    INTEGER, OPTIONAL, INTENT(OUT) :: ierror 10
                                        11
MPI_WIN_DELETE_ATTR(WIN, WIN_KEYVAL, IERROR) 12
    INTEGER WIN, WIN_KEYVAL, IERROR 13
                                        14
{void MPI::Win::Delete_attr(int win_keyval) (binding deprecated, see Section 15.2) 15
    } 16
                                        17

```

6.7.4 Datatypes

The new functions for caching on datatypes are:

```

MPI_TYPE_CREATE_KEYVAL(type_copy_attr_fn, type_delete_attr_fn, type_keyval, extra_state) 22
                                        23
    IN type_copy_attr_fn copy callback function for type_keyval (function) 24
    IN type_delete_attr_fn delete callback function for type_keyval (function) 25
    OUT type_keyval key value for future access (integer) 26
    IN extra_state extra state for callback functions 27
                                        28
                                        29
                                        30
int MPI_Type_create_keyval(MPI_Type_copy_attr_function *type_copy_attr_fn, 31
    MPI_Type_delete_attr_function *type_delete_attr_fn, 32
    int *type_keyval, void *extra_state) 33
                                        34 ticket-248T.
MPI_Type_create_keyval(type_copy_attr_fn, type_delete_attr_fn, type_keyval, 35
    extra_state, ierror) BIND(C) 36
    PROCEDURE(MPI_Type_copy_attr_function) :: type_copy_attr_fn 37
    PROCEDURE(MPI_Type_delete_attr_function) :: type_delete_attr_fn 38
    INTEGER, INTENT(OUT) :: type_keyval 39
    INTEGER(KIND=MPI_ADDRESS_KIND), INTENT(IN) :: extra_state 40
    INTEGER, OPTIONAL, INTENT(OUT) :: ierror 41
                                        42
MPI_TYPE_CREATE_KEYVAL(TYPE_COPY_ATTR_FN, TYPE_DELETE_ATTR_FN, TYPE_KEYVAL, 43
    EXTRA_STATE, IERROR) 44
    EXTERNAL TYPE_COPY_ATTR_FN, TYPE_DELETE_ATTR_FN 45
    INTEGER TYPE_KEYVAL, IERROR 46
    INTEGER(KIND=MPI_ADDRESS_KIND) EXTRA_STATE 47
                                        48

```

```

1 {static int MPI::Datatype::Create_keyval(MPI::Datatype::Copy_attr_function*
2     type_copy_attr_fn, MPI::Datatype::Delete_attr_function*
3     type_delete_attr_fn, void* extra_state) (binding deprecated, see
4     Section 15.2) }

```

The argument `type_copy_attr_fn` may be specified as `MPI_TYPE_NULL_COPY_FN` or `MPI_TYPE_DUP_FN` from either C, C++, or Fortran. `MPI_TYPE_NULL_COPY_FN` is a function that does nothing other than returning `flag = 0` and `MPI_SUCCESS`. `MPI_TYPE_DUP_FN` is a simple-minded copy function that sets `flag = 1`, returns the value of `attribute_val_in` in `attribute_val_out`, and returns `MPI_SUCCESS`.

The argument `type_delete_attr_fn` may be specified as `MPI_TYPE_NULL_DELETE_FN` from either C, C++, or Fortran. `MPI_TYPE_NULL_DELETE_FN` is a function that does nothing, other than returning `MPI_SUCCESS`.

The C callback functions are:

```

15 typedef int MPI_Type_copy_attr_function(MPI_Datatype oldtype,
16     int type_keyval, void *extra_state, void *attribute_val_in,
17     void *attribute_val_out, int *flag);

```

and

```

20 typedef int MPI_Type_delete_attr_function(MPI_Datatype datatype,
21     int type_keyval, void *attribute_val, void *extra_state);

```

With the `mpi_f08` module, the Fortran callback functions are:

ABSTRACT INTERFACE

```

25 SUBROUTINE MPI_Type_copy_attr_function(oldtype, type_keyval, extra_state,
26     attribute_val_in, attribute_val_out, flag, ierror) BIND(C)
27     TYPE(MPI_Datatype) :: oldtype
28     INTEGER :: type_keyval, ierror
29     INTEGER(KIND=MPI_ADDRESS_KIND) :: extra_state, attribute_val_in,
30     attribute_val_out
31     LOGICAL :: flag

```

and

ABSTRACT INTERFACE

```

35 SUBROUTINE MPI_Type_delete_attr_function(datatype, type_keyval,
36     attribute_val, extra_state, ierror) BIND(C)
37     TYPE(MPI_Datatype) :: datatype
38     INTEGER :: type_keyval, ierror
39     INTEGER(KIND=MPI_ADDRESS_KIND) :: attribute_val, extra_state

```

[The] With the `mpi` module and `mpif.h`, the Fortran callback functions are:

```

42 SUBROUTINE TYPE_COPY_ATTR_[FN]FUNCTION(OLDTYPE, TYPE_KEYVAL, EXTRA_STATE,
43     ATTRIBUTE_VAL_IN, ATTRIBUTE_VAL_OUT, FLAG, IERROR)
44     INTEGER OLDTYPE, TYPE_KEYVAL, IERROR
45     INTEGER(KIND=MPI_ADDRESS_KIND) EXTRA_STATE,
46     ATTRIBUTE_VAL_IN, ATTRIBUTE_VAL_OUT
47     LOGICAL FLAG

```

and

```
SUBROUTINE TYPE_DELETE_ATTR_ [FN] FUNCTION(DATATYPE, TYPE_KEYVAL,
      ATTRIBUTE_VAL, EXTRA_STATE, IERROR)
      INTEGER DATATYPE, TYPE_KEYVAL, IERROR
      INTEGER(KIND=MPI_ADDRESS_KIND) ATTRIBUTE_VAL, EXTRA_STATE
```

The C++ callbacks are:

```
{typedef int
      MPI::Datatype::Copy_attr_function(const MPI::Datatype& oldtype,
      int type_keyval, void* extra_state,
      const void* attribute_val_in, void* attribute_val_out,
      bool& flag); (binding deprecated, see Section 15.2)}
```

and

```
{typedef int MPI::Datatype::Delete_attr_function(MPI::Datatype& datatype,
      int type_keyval, void* attribute_val, void* extra_state);
      (binding deprecated, see Section 15.2)}
```

If an attribute copy function or attribute delete function returns other than MPI_SUCCESS, then the call that caused it to be invoked (for example, MPI_TYPE_FREE), is erroneous.

MPI_TYPE_FREE_KEYVAL(type_keyval)

INOUT type_keyval key value (integer)

int MPI_Type_free_keyval(int *type_keyval)

```
MPI_Type_free_keyval(type_keyval, ierror) BIND(C)
      INTEGER, INTENT(INOUT) :: type_keyval
      INTEGER, OPTIONAL, INTENT(OUT) :: ierror
```

MPI_TYPE_FREE_KEYVAL(TYPE_KEYVAL, IERROR)
INTEGER TYPE_KEYVAL, IERROR

```
{static void MPI::Datatype::Free_keyval(int& type_keyval) (binding deprecated,  
      see Section 15.2) }
```

MPI_TYPE_SET_ATTR(datatype, type_keyval, attribute_val)

INOUT [ticket252-W.]datatype datatype to which attribute will be attached (handle)
IN type_keyval key value (integer)
IN attribute_val attribute value

int MPI_Type_set_attr(MPI_Datatype datatype, int type_keyval,
void *attribute_val)

```
MPI_Type_set_attr(datatype, type_keyval, attribute_val, ierror) BIND(C)
```

```

1      TYPE(MPI_Datatype), INTENT(IN) :: datatype
2      INTEGER, INTENT(IN) :: type_keyval
3      INTEGER(KIND=MPI_ADDRESS_KIND), INTENT(IN) :: attribute_val
4      INTEGER, OPTIONAL, INTENT(OUT) :: ierror
5
ticket252-W. 6      MPI_TYPE_SET_ATTR(DATATYPE, TYPE_KEYVAL, ATTRIBUTE_VAL, IERROR)
ticket252-W. 7      INTEGER DATATYPE, TYPE_KEYVAL, IERROR
8      INTEGER(KIND=MPI_ADDRESS_KIND) ATTRIBUTE_VAL
9
10     {void MPI::Datatype::Set_attr(int type_keyval, const void*
11         attribute_val) (binding deprecated, see Section 15.2) }
12
13
ticket252-W. 14     MPI_TYPE_GET_ATTR(datatype, type_keyval, attribute_val, flag)
15         IN      [ticket252-W.]datatype      datatype to which the attribute is attached (handle)
16         IN      type_keyval                key value (integer)
17         OUT     attribute_val              attribute value, unless flag = false
18         OUT     flag                       false if no attribute is associated with the key (logical)
19
20
ticket252-W. 21     int MPI_Type_get_attr(MPI_Datatype datatype, int type_keyval, void
ticket-248T. 22         *attribute_val, int *flag)
23
24     MPI_Type_get_attr(datatype, type_keyval, attribute_val, flag, ierror)
25         BIND(C)
26         TYPE(MPI_Datatype), INTENT(IN) :: datatype
27         INTEGER, INTENT(IN) :: type_keyval
28         INTEGER(KIND=MPI_ADDRESS_KIND), INTENT(OUT) :: attribute_val
29         LOGICAL, INTENT(OUT) :: flag
30         INTEGER, OPTIONAL, INTENT(OUT) :: ierror
31
ticket252-W. 32     MPI_TYPE_GET_ATTR(DATATYPE, TYPE_KEYVAL, ATTRIBUTE_VAL, FLAG, IERROR)
ticket252-W. 33     INTEGER DATATYPE, TYPE_KEYVAL, IERROR
34     INTEGER(KIND=MPI_ADDRESS_KIND) ATTRIBUTE_VAL
35     LOGICAL FLAG
36
37     {bool MPI::Datatype::Get_attr(int type_keyval, void* attribute_val)
38         const(binding deprecated, see Section 15.2) }
39
40
ticket252-W. 41     MPI_TYPE_DELETE_ATTR(datatype, type_keyval)
42         INOUT   [ticket252-W.]datatype      datatype from which the attribute is deleted (handle)
43         IN      type_keyval                key value (integer)
44
45
ticket252-W. 46     int MPI_Type_delete_attr(MPI_Datatype datatype, int type_keyval)
ticket-248T. 47     MPI_Type_delete_attr(datatype, type_keyval, ierror) BIND(C)
48         TYPE(MPI_Datatype), INTENT(IN) :: datatype
49         INTEGER, INTENT(IN) :: type_keyval

```

```

    INTEGER, OPTIONAL, INTENT(OUT) :: ierror
MPI_TYPE_DELETE_ATTR(DATATYPE, TYPE_KEYVAL, IERROR)
    INTEGER DATATYPE, TYPE_KEYVAL, IERROR
{void MPI::Datatype::Delete_attr(int type_keyval) (binding deprecated, see
    Section 15.2) }

```

6.7.5 Error Class for Invalid Keyval

Key values for attributes are system-allocated, by `MPI_{TYPE,COMM,WIN}_CREATE_KEYVAL`. Only such values can be passed to the functions that use key values as input arguments. In order to signal that an erroneous key value has been passed to one of these functions, there is a new MPI error class: `MPI_ERR_KEYVAL`. It can be returned by `MPI_ATTR_PUT`, `MPI_ATTR_GET`, `MPI_ATTR_DELETE`, `MPI_KEYVAL_FREE`, `MPI_{TYPE,COMM,WIN}_DELETE_ATTR`, `MPI_{TYPE,COMM,WIN}_SET_ATTR`, `MPI_{TYPE,COMM,WIN}_GET_ATTR`, `MPI_{TYPE,COMM,WIN}_FREE_KEYVAL`, `MPI_COMM_DUP`, `MPI_COMM_DISCONNECT`, and `MPI_COMM_FREE`. The last three are included because `keyval` is an argument to the copy and delete functions for attributes.

6.7.6 Attributes Example

Advice to users. This example shows how to write a collective communication operation that uses caching to be more efficient after the first call. The coding style assumes that MPI function results return only error statuses. (*End of advice to users.*)

```

/* key for this module's stuff: */
static int gop_key = MPI_KEYVAL_INVALID;

typedef struct
{
    int ref_count;          /* reference count */
    /* other stuff, whatever else we want */
} gop_stuff_type;

void Efficient_Collective_Op (MPI_Comm comm, ...)
{
    gop_stuff_type *gop_stuff;
    MPI_Group      group;
    int            foundflag;

    MPI_Comm_group(comm, &group);

    if (gop_key == MPI_KEYVAL_INVALID) /* get a key on first call ever */
    {
        if ( ! MPI_Comm_create_keyval( gop_stuff_copier,
                                       gop_stuff_destructor,
                                       &gop_key, (void *)0));
        /* get the key while assigning its copy and delete callback

```

```

1         behavior. */
2
3         MPI_Abort (comm, 99);
4     }
5
6     MPI_Comm_get_attr (comm, gop_key, &gop_stuff, &foundflag);
7     if (foundflag)
8     { /* This module has executed in this group before.
9         We will use the cached information */
10    }
11    else
12    { /* This is a group that we have not yet cached anything in.
13        We will now do so.
14        */
15
16        /* First, allocate storage for the stuff we want,
17            and initialize the reference count */
18
19        gop_stuff = (gop_stuff_type *) malloc (sizeof(gop_stuff_type));
20        if (gop_stuff == NULL) { /* abort on out-of-memory error */ }
21
22        gop_stuff -> ref_count = 1;
23
24        /* Second, fill in *gop_stuff with whatever we want.
25            This part isn't shown here */
26
27        /* Third, store gop_stuff as the attribute value */
28        MPI_Comm_set_attr ( comm, gop_key, gop_stuff);
29    }
30    /* Then, in any case, use contents of *gop_stuff
31        to do the global op ... */
32    }
33
34    /* The following routine is called by MPI when a group is freed */
35
36    int gop_stuff_destructor (MPI_Comm comm, int keyval, void *gop_stuffP,
37                            void *extra)
38    {
39        gop_stuff_type *gop_stuff = (gop_stuff_type *)gop_stuffP;
40        if (keyval != gop_key) { /* abort -- programming error */ }
41
42        /* The group's being freed removes one reference to gop_stuff */
43        gop_stuff -> ref_count -= 1;
44
45        /* If no references remain, then free the storage */
46        if (gop_stuff -> ref_count == 0) {
47            free((void *)gop_stuff);
48        }

```

```

    return MPI_SUCCESS;
}

/* The following routine is called by MPI when a group is copied */
int gop_stuff_copier (MPI_Comm comm, int keyval, void *extra,
    void *gop_stuff_inP, void *gop_stuff_outP, int *flag)
{
    gop_stuff_type *gop_stuff_in = (gop_stuff_type *)gop_stuff_inP;
    gop_stuff_type **gop_stuff_out = (gop_stuff_type **)gop_stuff_outP;
    if (keyval != gop_key) { /* abort -- programming error */ }

    /* The new group adds one reference to this gop_stuff */
    gop_stuff_in -> ref_count += 1;
    *gop_stuff_out = gop_stuff_in;
    return MPI_SUCCESS;
}

```

6.8 Naming Objects

There are many occasions on which it would be useful to allow a user to associate a printable identifier with an MPI communicator, window, or datatype, for instance error reporting, debugging, and profiling. The names attached to opaque objects do not propagate when the object is duplicated or copied by MPI routines. For communicators this can be achieved using the following two functions.

`MPI_COMM_SET_NAME (comm, comm_name)`

INOUT	comm	communicator whose identifier is to be set (handle)
IN	comm_name	the character string which is remembered as the name (string)

```
int MPI_Comm_set_name(MPI_Comm comm, const char *comm_name)
```

```
MPI_Comm_set_name(comm, comm_name, ierror) BIND(C)
```

```

    TYPE(MPI_Comm), INTENT(IN) :: comm
    CHARACTER(LEN=*), INTENT(IN) :: comm_name
    INTEGER, OPTIONAL, INTENT(OUT) :: ierror

```

```
MPI_COMM_SET_NAME(COMM, COMM_NAME, IERROR)
```

```

    INTEGER COMM, IERROR
    CHARACTER*(*) COMM_NAME

```

```
{void MPI::Comm::Set_name(const char* comm_name) (binding deprecated, see
    Section 15.2) }
```

`MPI_COMM_SET_NAME` allows a user to associate a name string with a communicator. The character string which is passed to `MPI_COMM_SET_NAME` will be saved inside the MPI library (so it can be freed by the caller immediately after the call, or allocated on the

stack). Leading spaces in `name` are significant but trailing ones are not.

`MPI_COMM_SET_NAME` is a local (non-collective) operation, which only affects the name of the communicator as seen in the process which made the `MPI_COMM_SET_NAME` call. There is no requirement that the same (or any) name be assigned to a communicator in every process where it exists.

Advice to users. Since `MPI_COMM_SET_NAME` is provided to help debug code, it is sensible to give the same name to a communicator in all of the processes where it exists, to avoid confusion. (*End of advice to users.*)

The length of the name which can be stored is limited to the value of `MPI_MAX_OBJECT_NAME` in Fortran and `MPI_MAX_OBJECT_NAME-1` in C and C++ to allow for the null terminator. Attempts to put names longer than this will result in truncation of the name. `MPI_MAX_OBJECT_NAME` must have a value of at least 64.

Advice to users. Under circumstances of store exhaustion an attempt to put a name of any length could fail, therefore the value of `MPI_MAX_OBJECT_NAME` should be viewed only as a strict upper bound on the name length, not a guarantee that setting names of less than this length will always succeed. (*End of advice to users.*)

Advice to implementors. Implementations which pre-allocate a fixed size space for a name should use the length of that allocation as the value of `MPI_MAX_OBJECT_NAME`. Implementations which allocate space for the name from the heap should still define `MPI_MAX_OBJECT_NAME` to be a relatively small value, since the user has to allocate space for a string of up to this size when calling `MPI_COMM_GET_NAME`. (*End of advice to implementors.*)

`MPI_COMM_GET_NAME` (`comm`, `comm_name`, `resultlen`)

IN	<code>comm</code>	communicator whose name is to be returned (handle)
OUT	<code>comm_name</code>	the name previously stored on the communicator, or an empty string if no such name exists (string)
OUT	<code>resultlen</code>	length of returned name (integer)

```
int MPI_Comm_get_name(MPI_Comm comm, char *comm_name, int *resultlen)
```

```
MPI_Comm_get_name(comm, comm_name, resultlen, ierror) BIND(C)
  TYPE(MPI_Comm), INTENT(IN) :: comm
  CHARACTER(LEN=MPI_MAX_OBJECT_NAME), INTENT(OUT) :: comm_name
  INTEGER, INTENT(OUT) :: resultlen
  INTEGER, OPTIONAL, INTENT(OUT) :: ierror
```

```
MPI_COMM_GET_NAME(COMM, COMM_NAME, RESULTLEN, IERROR)
```

```
  INTEGER COMM, RESULTLEN, IERROR
```

```
  CHARACTER*(*) COMM_NAME
```

```
{void MPI::Comm::Get_name(char* comm_name, int& resultlen) const(binding
  deprecated, see Section 15.2) }
```

MPI_COMM_GET_NAME returns the last name which has previously been associated with the given communicator. The name may be set and got from any language. The same name will be returned independent of the language used. `name` should be allocated so that it can hold a resulting string of length MPI_MAX_OBJECT_NAME characters.

MPI_COMM_GET_NAME returns a copy of the set name in `name`.

In C, a null character is additionally stored at `name[resultlen]`. The value of `resultlen` cannot be larger [then]than MPI_MAX_OBJECT_NAME-1. In Fortran, `name` is padded on the right with blank characters. The value of `resultlen` cannot be larger [then]than MPI_MAX_OBJECT_NAME.

If the user has not associated a name with a communicator, or an error occurs, MPI_COMM_GET_NAME will return an empty string (all spaces in Fortran, "" in C and C++). The three predefined communicators will have predefined names associated with them. Thus, the names of MPI_COMM_WORLD, MPI_COMM_SELF, and the communicator returned by MPI_COMM_GET_PARENT (if not MPI_COMM_NULL) will have the default of MPI_COMM_WORLD, MPI_COMM_SELF, and MPI_COMM_PARENT. The fact that the system may have chosen to give a default name to a communicator does not prevent the user from setting a name on the same communicator; doing this removes the old name and assigns the new one.

Rationale. We provide separate functions for setting and getting the name of a communicator, rather than simply providing a predefined attribute key for the following reasons:

- It is not, in general, possible to store a string as an attribute from Fortran.
- It is not easy to set up the delete function for a string attribute unless it is known to have been allocated from the heap.
- To make the attribute key useful additional code to call `strdup` is necessary. If this is not standardized then users have to write it. This is extra unneeded work which we can easily eliminate.
- The Fortran binding is not trivial to write (it will depend on details of the Fortran compilation system), and will not be portable. Therefore it should be in the library rather than in user code.

(End of rationale.)

Advice to users. The above definition means that it is safe simply to print the string returned by MPI_COMM_GET_NAME, as it is always a valid string even if there was no name.

Note that associating a name with a communicator has no effect on the semantics of an MPI program, and will (necessarily) increase the store requirement of the program, since the names must be saved. Therefore there is no requirement that users use these functions to associate names with communicators. However debugging and profiling MPI applications may be made easier if names are associated with communicators, since the debugger or profiler should then be able to present information in a less cryptic manner. *(End of advice to users.)*

The following functions are used for setting and getting names of datatypes. The constant MPI_MAX_OBJECT_NAME also applies to these names.

```

ticket252-W. 1 MPI_TYPE_SET_NAME (datatype, type_name)
2
3     INOUT    [ticket252-W.]datatype    datatype whose identifier is to be set (handle)
4     IN      type_name                the character string which is remembered as the name
5                                         (string)
6
ticket252-W. 7 int MPI_Type_set_name(MPI_Datatype datatype, const char *type_name)
ticket140. 8
ticket-248T. 9 MPI_Type_set_name(datatype, type_name, ierror) BIND(C)
10     TYPE(MPI_Datatype), INTENT(IN) :: datatype
11     CHARACTER(LEN=*), INTENT(IN) :: type_name
12     INTEGER, OPTIONAL, INTENT(OUT) :: ierror
13
ticket252-W. 13 MPI_TYPE_SET_NAME(DATATYPE, TYPE_NAME, IERROR)
ticket252-W. 14     INTEGER DATATYPE, IERROR
15     CHARACTER*(*) TYPE_NAME
16
17     {void MPI::Datatype::Set_name(const char* type_name) (binding deprecated, see
18         Section 15.2) }
19
20
ticket252-W. 21 MPI_TYPE_GET_NAME (datatype, type_name, resultlen)
22
23     IN      [ticket252-W.]datatype    datatype whose name is to be returned (handle)
24     OUT    type_name                the name previously stored on the datatype, or a empty
25                                         string if no such name exists (string)
26     OUT    resultlen                length of returned name (integer)
27
28
ticket252-W. 28 int MPI_Type_get_name(MPI_Datatype datatype, char *type_name, int
29     *resultlen)
ticket-248T. 30
31 MPI_Type_get_name(datatype, type_name, resultlen, ierror) BIND(C)
32     TYPE(MPI_Datatype), INTENT(IN) :: datatype
33     CHARACTER(LEN=MPI_MAX_OBJECT_NAME), INTENT(OUT) :: type_name
34     INTEGER, INTENT(OUT) :: resultlen
35     INTEGER, OPTIONAL, INTENT(OUT) :: ierror
36
ticket252-W. 36 MPI_TYPE_GET_NAME(DATATYPE, TYPE_NAME, RESULTLEN, IERROR)
ticket252-W. 37     INTEGER DATATYPE, RESULTLEN, IERROR
38     CHARACTER*(*) TYPE_NAME
39
40     {void MPI::Datatype::Get_name(char* type_name, int& resultlen) const (binding
41         deprecated, see Section 15.2) }
42
43     Named predefined datatypes have the default names of the datatype name. For exam-
44     ple, MPI_WCHAR has the default name of MPI_WCHAR.
45     The following functions are used for setting and getting names of windows. The con-
46     stant MPI_MAX_OBJECT_NAME also applies to these names.
47
48

```

```

MPI_WIN_SET_NAME (win, win_name)
    INOUT    win                window whose identifier is to be set (handle)
    IN       win_name           the character string which is remembered as the name
                                (string)

int MPI_Win_set_name(MPI_Win win, const char *win_name)

MPI_Win_set_name(win, win_name, ierror) BIND(C)
    TYPE(MPI_Win), INTENT(IN) :: win
    CHARACTER(LEN=*), INTENT(IN) :: win_name
    INTEGER, OPTIONAL, INTENT(OUT) :: ierror

MPI_WIN_SET_NAME(WIN, WIN_NAME, IERROR)
    INTEGER WIN, IERROR
    CHARACTER*(*) WIN_NAME

{void MPI::Win::Set_name(const char* win_name) (binding deprecated, see
    Section 15.2) }

MPI_WIN_GET_NAME (win, win_name, resultlen)
    IN       win                window whose name is to be returned (handle)
    OUT      win_name           the name previously stored on the window, or a empty
                                string if no such name exists (string)
    OUT      resultlen          length of returned name (integer)

int MPI_Win_get_name(MPI_Win win, char *win_name, int *resultlen)

MPI_Win_get_name(win, win_name, resultlen, ierror) BIND(C)
    TYPE(MPI_Win), INTENT(IN) :: win
    CHARACTER(LEN=MPI_MAX_OBJECT_NAME), INTENT(OUT) :: win_name
    INTEGER, INTENT(OUT) :: resultlen
    INTEGER, OPTIONAL, INTENT(OUT) :: ierror

MPI_WIN_GET_NAME(WIN, WIN_NAME, RESULTLEN, IERROR)
    INTEGER WIN, RESULTLEN, IERROR
    CHARACTER*(*) WIN_NAME

{void MPI::Win::Get_name(char* win_name, int& resultlen) const (binding
    deprecated, see Section 15.2) }

```

6.9 Formalizing the Loosely Synchronous Model

In this section, we make further statements about the loosely synchronous model, with particular attention to intra-communication.

6.9.1 Basic Statements

When a caller passes a communicator (that contains a context and group) to a callee, that communicator must be free of side effects throughout execution of the subprogram: there should be no active operations on that communicator that might involve the process. This provides one model in which libraries can be written, and work “safely.” For libraries so designated, the callee has permission to do whatever communication it likes with the communicator, and under the above guarantee knows that no other communications will interfere. Since we permit good implementations to create new communicators without synchronization (such as by preallocated contexts on communicators), this does not impose a significant overhead.

This form of safety is analogous to other common computer-science usages, such as passing a descriptor of an array to a library routine. The library routine has every right to expect such a descriptor to be valid and modifiable.

6.9.2 Models of Execution

In the loosely synchronous model, transfer of control to a **parallel procedure** is effected by having each executing process invoke the procedure. The invocation is a collective operation: it is executed by all processes in the execution group, and invocations are similarly ordered at all processes. However, the invocation need not be synchronized.

We say that a parallel procedure is *active* in a process if the process belongs to a group that may collectively execute the procedure, and some member of that group is currently executing the procedure code. If a parallel procedure is active in a process, then this process may be receiving messages pertaining to this procedure, even if it does not currently execute the code of this procedure.

Static communicator allocation

This covers the case where, at any point in time, at most one invocation of a parallel procedure can be active at any process, and the group of executing processes is fixed. For example, all invocations of parallel procedures involve all processes, processes are single-threaded, and there are no recursive invocations.

In such a case, a communicator can be statically allocated to each procedure. The static allocation can be done in a preamble, as part of initialization code. If the parallel procedures can be organized into libraries, so that only one procedure of each library can be concurrently active in each processor, then it is sufficient to allocate one communicator per library.

Dynamic communicator allocation

Calls of parallel procedures are well-nested if a new parallel procedure is always invoked in a subset of a group executing the same parallel procedure. Thus, processes that execute the same parallel procedure have the same execution stack.

In such a case, a new communicator needs to be dynamically allocated for each new invocation of a parallel procedure. The allocation is done by the caller. A new communicator can be generated by a call to `MPI_COMM_DUP`, if the callee execution group is identical to the caller execution group, or by a call to `MPI_COMM_SPLIT` if the caller execution group

is split into several subgroups executing distinct parallel routines. The new communicator is passed as an argument to the invoked routine.

The need for generating a new communicator at each invocation can be alleviated or avoided altogether in some cases: If the execution group is not split, then one can allocate a stack of communicators in a preamble, and next manage the stack in a way that mimics the stack of recursive calls.

One can also take advantage of the well-ordering property of communication to avoid confusing caller and callee communication, even if both use the same communicator. To do so, one needs to abide by the following two rules:

- messages sent before a procedure call (or before a return from the procedure) are also received before the matching call (or return) at the receiving end;
- messages are always selected by source (no use is made of `MPI_ANY_SOURCE`).

The General [c]Case

In the general case, there may be multiple concurrently active invocations of the same parallel procedure within the same group; invocations may not be well-nested. A new communicator needs to be created for each invocation. It is the user's responsibility to make sure that, should two distinct parallel procedures be invoked concurrently on overlapping sets of processes, then communicator creation be properly coordinated.

1
2
3
4
5
6
7
8
9
10
11
12
13
14
15
16 ticket0.
17
18
19
20
21
22
23
24
25
26
27
28
29
30
31
32
33
34
35
36
37
38
39
40
41
42
43
44
45
46
47
48

1
2
3
4
5
6
7
8
9
10
11
12
13
14
15
16
17
18
19
20
21
22
23
24
25
26
27
28
29
30
31
32
33
34
35
36
37
38
39
40
41
42
43
44
45
46
47
48

1
2
3
4
5
6
7
8
9
10
11
12
13
14
15
16
17
18
19
20
21
22
23
24
25
26
27
28
29
30
31
32
33
34
35
36
37
38
39
40
41
42
43
44
45
46
47
48

Chapter 7

Process Topologies

7.1 Introduction

This chapter discusses the MPI topology mechanism. A topology is an extra, optional attribute that one can give to an intra-communicator; topologies cannot be added to inter-communicators. A topology can provide a convenient naming mechanism for the processes of a group (within a communicator), and additionally, may assist the runtime system in mapping the processes onto hardware.

As stated in Chapter 6, a process group in MPI is a collection of n processes. Each process in the group is assigned a rank between 0 and $n-1$. In many parallel applications a linear ranking of processes does not adequately reflect the logical communication pattern of the processes (which is usually determined by the underlying problem geometry and the numerical algorithm used). Often the processes are arranged in topological patterns such as two- or three-dimensional grids. More generally, the logical process arrangement is described by a graph. In this chapter we will refer to this logical process arrangement as the “virtual topology.”

A clear distinction must be made between the virtual process topology and the topology of the underlying, physical hardware. The virtual topology can be exploited by the system in the assignment of processes to physical processors, if this helps to improve the communication performance on a given machine. How this mapping is done, however, is outside the scope of MPI. The description of the virtual topology, on the other hand, depends only on the application, and is machine-independent. The functions that are described in this chapter deal [only]with machine-independent mapping and communication on virtual process topologies.

ticket258.
ticket258.

Rationale. Though physical mapping is not discussed, the existence of the virtual topology information may be used as advice by the runtime system. There are well-known techniques for mapping grid/torus structures to hardware topologies such as hypercubes or grids. For more complicated graph structures good heuristics often yield nearly optimal results [44]. On the other hand, if there is no way for the user to specify the logical process arrangement as a “virtual topology,” a random mapping is most likely to result. On some machines, this will lead to unnecessary contention in the interconnection network. Some details about predicted and measured performance improvements that result from good process-to-processor mapping on modern wormhole-routing architectures can be found in [11, 12].

Besides possible performance benefits, the virtual topology can function as a convenient, process-naming structure, with significant benefits for program readability and notational power in message-passing programming. (*End of rationale.*)

7.2 Virtual Topologies

The communication pattern of a set of processes can be represented by a graph. The nodes represent processes, and the edges connect processes that communicate with each other. MPI provides message-passing between any pair of processes in a group. There is no requirement for opening a channel explicitly. Therefore, a “missing link” in the user-defined process graph does not prevent the corresponding processes from exchanging messages. It means rather that this connection is neglected in the virtual topology. This strategy implies that the topology gives no convenient way of naming this pathway of communication. Another possible consequence is that an automatic mapping tool (if one exists for the runtime environment) will not take account of this edge when mapping.

Specifying the virtual topology in terms of a graph is sufficient for all applications. However, in many applications the graph structure is regular, and the detailed set-up of the graph would be inconvenient for the user and might be less efficient at run time. A large fraction of all parallel applications use process topologies like rings, two- or higher-dimensional grids, or tori. These structures are completely defined by the number of dimensions and the numbers of processes in each coordinate direction. Also, the mapping of grids and tori is generally an easier problem [then]than that of general graphs. Thus, it is desirable to address these cases explicitly.

Process coordinates in a Cartesian structure begin their numbering at 0. Row-major numbering is always used for the processes in a Cartesian structure. This means that, for example, the relation between group rank and coordinates for four processes in a (2×2) grid is as follows.

```
coord (0,0):  rank 0
coord (0,1):  rank 1
coord (1,0):  rank 2
coord (1,1):  rank 3
```

7.3 Embedding in MPI

The support for virtual topologies as defined in this chapter is consistent with other parts of MPI, and, whenever possible, makes use of functions that are defined elsewhere. Topology information is associated with communicators. It is added to communicators using the caching mechanism described in Chapter 6.

7.4 Overview of the Functions

[The functions `MPI_GRAPH_CREATE`, `MPI_DIST_GRAPH_CREATE_ADJACENT`, `MPI_DIST_GRAPH_CREATE` and `MPI_CART_CREATE` are used to create general (graph) virtual topologies and Cartesian topologies, respectively. These topology creation functions are collective. As with other collective calls, the program must be written to work correctly, whether the call synchronizes or not.]MPI supports three topology types: Cartesian,

graph, and distributed graph. The function `MPI_CART_CREATE` is used to create Cartesian topologies, the function `MPI_GRAPH_CREATE` is used to create graph topologies, and the functions `MPI_DIST_GRAPH_CREATE_ADJACENT` and `MPI_DIST_GRAPH_CREATE` are used to create distributed graph topologies.

The topology creation functions take as input an existing communicator `comm_old`, which defines the set of processes on which the topology is to be mapped. For `MPI_GRAPH_CREATE` and `MPI_CART_CREATE`, all input arguments must have identical values on all processes of the group of `comm_old`. [For `MPI_DIST_GRAPH_CREATE_ADJACENT` and `MPI_DIST_GRAPH_CREATE` the input communication graph is distributed across the calling processes.] When calling `MPI_GRAPH_CREATE`, each process specifies all nodes and edges in the graph. In contrast, the functions `MPI_DIST_GRAPH_CREATE_ADJACENT` or `MPI_DIST_GRAPH_CREATE` are used to specify the graph in a distributed fashion, whereby each process only specifies a subset of the edges in the graph such that the entire graph structure is defined collectively across the set of processes. Therefore the processes provide different values for the arguments specifying the graph. However, all processes must give the same value for `reorder` and the `info` argument. In all cases, a new communicator `comm_topol` is created that carries the topological structure as cached information (see Chapter 6). In analogy to function `MPI_COMM_CREATE`, no cached information propagates from `comm_old` to `comm_topol`.

`MPI_CART_CREATE` can be used to describe Cartesian structures of arbitrary dimension. For each coordinate direction one specifies whether the process structure is periodic or not. Note that an n -dimensional hypercube is an n -dimensional torus with 2 processes per coordinate direction. Thus, special support for hypercube structures is not necessary. The local auxiliary function `MPI_DIMS_CREATE` can be used to compute a balanced distribution of processes among a given number of dimensions.

Rationale. Similar functions are contained in EXPRESS [13] and PARMACS. (*End of rationale.*)

[The function `MPI_TOPO_TEST` can be used to inquire about the topology associated with a communicator. The topological information can be extracted from the communicator using the functions `MPI_GRAPHDIMS_GET` and `MPI_GRAPH_GET`, for general graphs, and `MPI_CARTDIM_GET` and `MPI_CART_GET`, for Cartesian topologies. Several additional functions are provided to manipulate Cartesian topologies: the functions `MPI_CART_RANK` and `MPI_CART_COORDS` translate Cartesian coordinates into a group rank, and vice-versa; the function `MPI_CART_SUB` can be used to extract a Cartesian subspace (analogous to `MPI_COMM_SPLIT`). The function `MPI_CART_SHIFT` provides the information needed to communicate with neighbors in a Cartesian dimension. The two functions `MPI_GRAPH_NEIGHBORS_COUNT` and `MPI_GRAPH_NEIGHBORS` can be used to extract the neighbors of a node in a graph. For distributed graphs, the functions `MPI_DIST_NEIGHBORS_COUNT` and `MPI_DIST_NEIGHBORS` can be used to extract the neighbors of the calling node. The function `MPI_CART_SUB` is collective over the input communicator's group; all other functions are local.] MPI defines functions to query a communicator for topology information. The function `MPI_TOPO_TEST` is used to query for the type of topology associated with a communicator. Depending on the topology type, different information can be extracted. For a graph topology, the functions `MPI_GRAPHDIMS_GET` and `MPI_GRAPH_GET` return the values that were specified in the call to `MPI_GRAPH_CREATE`. Additionally, the functions `MPI_GRAPH_NEIGHBORS_COUNT`

and `MPI_GRAPH_NEIGHBORS` can be used to obtain the neighbors of an arbitrary node in the graph. For a distributed graph topology, the functions `MPI_DIST_GRAPH_NEIGHBORS_COUNT` and `MPI_DIST_GRAPH_NEIGHBORS` can be used to obtain the neighbors of the calling process. For a Cartesian topology, the functions `MPI_CARTDIM_GET` and `MPI_CART_GET` return the values that were specified in the call to `MPI_CART_CREATE`. Additionally, the functions `MPI_CART_RANK` and `MPI_CART_COORDS` translate Cartesian coordinates into a group rank, and vice-versa. The function `MPI_CART_SHIFT` provides the information needed to communicate with neighbors along a Cartesian dimension. All of these query functions are local.

For Cartesian topologies, the function `MPI_CART_SUB` can be used to extract a Cartesian subspace (analogous to `MPI_COMM_SPLIT`). This function is collective over the input communicator's group.

Two additional functions, `MPI_GRAPH_MAP` and `MPI_CART_MAP` are presented in the last section. In general these functions are not called by the user directly. However, together with the communicator manipulation functions presented in Chapter 6, they are sufficient to implement all other topology functions. Section 7.5.8 outlines such an implementation.

The neighborhood collective communication routines `MPI_NEIGHBOR_ALLGATHER`, `MPI_NEIGHBOR_ALLGATHERV`, `MPI_NEIGHBOR_ALLTOALL`, `MPI_NEIGHBOR_ALLTOALLV`, and `MPI_NEIGHBOR_ALLTOALLW` communicate with the nearest neighbors on the topology associated with the communicator. The nonblocking variants are `MPI_INEIGHBOR_ALLGATHER`, `MPI_INEIGHBOR_ALLGATHERV`, `MPI_INEIGHBOR_ALLTOALL`, `MPI_INEIGHBOR_ALLTOALLV`, and `MPI_INEIGHBOR_ALLTOALLW`.

7.5 Topology Constructors

7.5.1 Cartesian Constructor

```
MPI_CART_CREATE(comm_old, ndims, dims, periods, reorder, comm_cart)
```

IN	<code>comm_old</code>	input communicator (handle)
IN	<code>ndims</code>	number of dimensions of Cartesian grid (integer)
IN	<code>dims</code>	integer array of size <code>ndims</code> specifying the number of processes in each dimension
IN	<code>periods</code>	logical array of size <code>ndims</code> specifying whether the grid is periodic (<code>true</code>) or not (<code>false</code>) in each dimension
IN	<code>reorder</code>	ranking may be reordered (<code>true</code>) or not (<code>false</code>) (logical)
OUT	<code>comm_cart</code>	communicator with new Cartesian topology (handle)

```
int MPI_Cart_create(MPI_Comm comm_old, int ndims, const int [*dims]dims[],
                  const int [*periods]periods[], int reorder,
                  MPI_Comm *comm_cart)
```

```
MPI_Cart_create(comm_old, ndims, dims, periods, reorder, comm_cart, ierror)
                BIND(C)
```

```

TYPE(MPI_Comm), INTENT(IN) :: comm_old
INTEGER, INTENT(IN) :: ndims, dims(ndims)
LOGICAL, INTENT(IN) :: periods(ndims), reorder
TYPE(MPI_Comm), INTENT(OUT) :: comm_cart
INTEGER, OPTIONAL, INTENT(OUT) :: ierror

MPI_CART_CREATE(COMM_OLD, NDIMS, DIMS, PERIODS, REORDER, COMM_CART, IERROR)
  INTEGER COMM_OLD, NDIMS, DIMS(*), COMM_CART, IERROR
  LOGICAL PERIODS(*), REORDER

{MPI::Cartcomm MPI::Intracomm::Create_cart(int ndims, const int dims[],
      const bool periods[], bool reorder) const(binding deprecated, see
      Section 15.2)}

```

MPI_CART_CREATE returns a handle to a new communicator to which the Cartesian topology information is attached. If `reorder = false` then the rank of each process in the new group is identical to its rank in the old group. Otherwise, the function may reorder the processes (possibly so as to choose a good embedding of the virtual topology onto the physical machine). If the total size of the Cartesian grid is smaller than the size of the group of `[comm]comm_old`, then some processes are returned MPI_COMM_NULL, in analogy to MPI_COMM_SPLIT. If `ndims` is zero then a zero-dimensional Cartesian topology is created. The call is erroneous if it specifies a grid that is larger than the group size or if `ndims` is negative.

7.5.2 Cartesian Convenience Function: MPI_DIMS_CREATE

For Cartesian topologies, the function MPI_DIMS_CREATE helps the user select a balanced distribution of processes per coordinate direction, depending on the number of processes in the group to be balanced and optional constraints that can be specified by the user. One use is to partition all the processes (the size of MPI_COMM_WORLD's group) into an n -dimensional topology.

```

MPI_DIMS_CREATE(nnodes, ndims, dims)
  IN      nnodes      number of nodes in a grid (integer)
  IN      ndims       number of Cartesian dimensions (integer)
  INOUT   dims        integer array of size ndims specifying the number of
                      nodes in each dimension

int MPI_Dims_create(int nnodes, int ndims, int [*dims]dims[])

MPI_Dims_create(nnodes, ndims, dims, ierror) BIND(C)
  INTEGER, INTENT(IN) :: nnodes, ndims
  INTEGER, INTENT(INOUT) :: dims(ndims)
  INTEGER, OPTIONAL, INTENT(OUT) :: ierror

MPI_DIMS_CREATE(NNODES, NDIMS, DIMS, IERROR)
  INTEGER NNODES, NDIMS, DIMS(*), IERROR

```

```

1 {void MPI::Compute_dims(int nnodes, int ndims, int dims[]) (binding deprecated,
2     see Section 15.2) }
3

```

The entries in the array `dims` are set to describe a Cartesian grid with `ndims` dimensions and a total of `nnodes` nodes. The dimensions are set to be as close to each other as possible, using an appropriate divisibility algorithm. The caller may further constrain the operation of this routine by specifying elements of array `dims`. If `dims[i]` is set to a positive number, the routine will not modify the number of nodes in dimension `i`; only those entries where `dims[i] = 0` are modified by the call.

Negative input values of `dims[i]` are erroneous. An error will occur if `nnodes` is not a multiple of $\prod_{i, \text{dims}[i] \neq 0} \text{dims}[i]$.

For `dims[i]` set by the call, `dims[i]` will be ordered in non-increasing order. Array `dims` is suitable for use as input to routine `MPI_CART_CREATE`. `MPI_DIMS_CREATE` is local.

Example 7.1

dims before call	function call	dims on return
(0,0)	<code>MPI_DIMS_CREATE(6, 2, dims)</code>	(3,2)
(0,0)	<code>MPI_DIMS_CREATE(7, 2, dims)</code>	(7,1)
(0,3,0)	<code>MPI_DIMS_CREATE(6, 3, dims)</code>	(2,3,1)
(0,3,0)	<code>MPI_DIMS_CREATE(7, 3, dims)</code>	erroneous call

7.5.3 [General (Graph)]Graph Constructor

```

29 MPI_GRAPH_CREATE(comm_old, nnodes, index, edges, reorder, comm_graph)
30

```

IN	<code>comm_old</code>	input communicator (handle)
IN	<code>nnodes</code>	number of nodes in graph (integer)
IN	<code>index</code>	array of integers describing node degrees (see below)
IN	<code>edges</code>	array of integers describing graph edges (see below)
IN	<code>reorder</code>	ranking may be reordered (true) or not (false) (logical)
OUT	<code>comm_graph</code>	communicator with graph topology added (handle)

```

39 int MPI_Graph_create(MPI_Comm comm_old, int nnodes, const
40     int [*index]index[], const int [*edges]edges[], int reorder,
41     MPI_Comm *comm_graph)
42

```

```

43 MPI_Graph_create(comm_old, nnodes, index, edges, reorder, comm_graph,
44     ierror) BIND(C)
45     TYPE(MPI_Comm), INTENT(IN) :: comm_old
46     INTEGER, INTENT(IN) :: nnodes, index(nnodes), edges(*)
47     LOGICAL, INTENT(IN) :: reorder
48     TYPE(MPI_Comm), INTENT(OUT) :: comm_graph

```

```

INTEGER, OPTIONAL, INTENT(OUT) :: ierror
MPI_GRAPH_CREATE(COMM_OLD, NNODES, INDEX, EDGES, REORDER, COMM_GRAPH,
                 IERROR)
    INTEGER COMM_OLD, NNODES, INDEX(*), EDGES(*), COMM_GRAPH, IERROR
    LOGICAL REORDER
{MPI::Graphcomm MPI::Intracomm::Create_graph(int nnodes, const int index[],
      const int edges[], bool reorder) const(binding deprecated, see
      Section 15.2) }

```

MPI_GRAPH_CREATE returns a handle to a new communicator to which the graph topology information is attached. If `reorder = false` then the rank of each process in the new group is identical to its rank in the old group. Otherwise, the function may reorder the processes. If the size, `nnodes`, of the graph is smaller than the size of the group of `[comm]comm_old`, then some processes are returned MPI_COMM_NULL, in analogy to MPI_CART_CREATE and MPI_COMM_SPLIT. If the graph is empty, i.e., `nnodes == 0`, then MPI_COMM_NULL is returned in all processes. The call is erroneous if it specifies a graph that is larger than the group size of the input communicator.

The three parameters `nnodes`, `index` and `edges` define the graph structure. `nnodes` is the number of nodes of the graph. The nodes are numbered from 0 to `nnodes-1`. The *i*-th entry of array `index` stores the total number of neighbors of the first *i* graph nodes. The lists of neighbors of nodes 0, 1, ..., `nnodes-1` are stored in consecutive locations in array `edges`. The array `edges` is a flattened representation of the edge lists. The total number of entries in `index` is `nnodes` and the total number of entries in `edges` is equal to the number of graph edges.

The definitions of the arguments `nnodes`, `index`, and `edges` are illustrated with the following simple example.

Example 7.2

Assume there are four processes 0, 1, 2, 3 with the following adjacency matrix:

process	neighbors
0	1, 3
1	0
2	3
3	0, 2

Then, the input arguments are:

```

nnodes = 4
index = 2, 3, 4, 6
edges = 1, 3, 0, 3, 0, 2

```

Thus, in C, `index[0]` is the degree of node zero, and `index[i] - index[i-1]` is the degree of node *i*, *i*=1, ..., `nnodes-1`; the list of neighbors of node zero is stored in `edges[j]`, for $0 \leq j \leq \text{index}[0] - 1$ and the list of neighbors of node *i*, *i* > 0, is stored in `edges[j]`, $\text{index}[i-1] \leq j \leq \text{index}[i] - 1$.

In Fortran, `index(1)` is the degree of node zero, and `index(i+1) - index(i)` is the degree of node *i*, *i*=1, ..., `nnodes-1`; the list of neighbors of node zero is stored in `edges(j)`, for $1 \leq j \leq \text{index}(1)$ and the list of neighbors of node *i*, *i* > 0, is stored in

edges(j), $\text{index}(i) + 1 \leq j \leq \text{index}(i + 1)$.

A single process is allowed to be defined multiple times in the list of neighbors of a process (i.e., there may be multiple edges between two processes). A process is also allowed to be a neighbor to itself (i.e., a self loop in the graph). The adjacency matrix is allowed to be non-symmetric.

Advice to users. Performance implications of using multiple edges or a non-symmetric adjacency matrix are not defined. The definition of a node-neighbor edge does not imply a direction of the communication. (*End of advice to users.*)

Advice to implementors. The following topology information is likely to be stored with a communicator:

- Type of topology (Cartesian/graph),
- For a Cartesian topology:
 1. `ndims` (number of dimensions),
 2. `dims` (numbers of processes per coordinate direction),
 3. `periods` (periodicity information),
 4. `own_position` (own position in grid, could also be computed from rank and `dims`)

- For a graph topology:

1. `index`,
2. `edges`,

which are the vectors defining the graph structure.

For a graph structure the number of nodes is equal to the number of processes in the group. Therefore, the number of nodes does not have to be stored explicitly. An additional zero entry at the start of array `index` simplifies access to the topology information. (*End of advice to implementors.*)

7.5.4 [Distributed (Graph)]Distributed Graph Constructor

[The general graph constructor assumes] `MPI_GRAPH_CREATE` requires that each process passes the full (global) communication graph to the call. This limits the scalability of this constructor. With the distributed graph interface, the communication graph is specified in a fully distributed fashion. Each process specifies only the part of the communication graph of which it is aware. Typically, this could be the set of processes from which the process will eventually receive or get data, or the set of processes to which the process will send or put data, or some combination of such edges. Two different interfaces can be used to create a distributed graph topology. `MPI_DIST_GRAPH_CREATE_ADJACENT` creates a distributed graph communicator with each process specifying [all]each of its incoming and outgoing (adjacent) edges in the logical communication graph and thus requires minimal communication during creation. [MPI_DIST_GRAPH_CREATE provides full flexibility, and processes can indicate that communication will occur between other pairs of processes.] `MPI_DIST_GRAPH_CREATE` provides full flexibility such that any process can indicate that communication will occur between any pair of processes in the graph.

To provide better possibilities for optimization by the MPI library, the distributed graph constructors permit weighted communication edges and take an `info` argument that

can further influence process reordering or other optimizations performed by the MPI library. For example, hints can be provided on how edge weights are to be interpreted, the quality of the reordering, and/or the time permitted for the MPI library to process the graph.

`MPI_DIST_GRAPH_CREATE_ADJACENT(comm_old, indegree, sources, sourceweights, outdegree, destinations, destweights, info, reorder, comm_dist_graph)`

IN	<code>comm_old</code>	input communicator (handle)	
IN	<code>indegree</code>	size of <code>sources</code> and <code>sourceweights</code> arrays (non-negative integer)	
IN	<code>sources</code>	ranks of processes for which the calling process is a destination (array of non-negative integers)	
IN	<code>sourceweights</code>	weights of the edges into the calling process (array of non-negative integers)	
IN	<code>outdegree</code>	size of <code>destinations</code> and <code>destweights</code> arrays (non-negative integer)	
IN	<code>destinations</code>	ranks of processes for which the calling process is a source (array of non-negative integers)	
IN	<code>destweights</code>	weights of the edges out of the calling process (array of non-negative integers)	
IN	<code>info</code>	hints on optimization and interpretation of weights (handle)	
IN	<code>reorder</code>	the ranks may be reordered (true) or not (false) (logical)	
OUT	<code>comm_dist_graph</code>	communicator with distributed graph topology (handle)	

```
int MPI_Dist_graph_create_adjacent(MPI_Comm comm_old, int indegree, const
    int sources[], const int sourceweights[], int outdegree, const
    int destinations[], const int destweights[], MPI_Info info,
    int reorder, MPI_Comm *comm_dist_graph)
```

```
MPI_Dist_graph_create_adjacent(comm_old, indegree, sources, sourceweights,
    outdegree, destinations, destweights, info, reorder,
    comm_dist_graph, ierror) BIND(C)
```

```
TYPE(MPI_Comm), INTENT(IN) :: comm_old
INTEGER, INTENT(IN) :: indegree, sources(indegree), outdegree,
destinations(outdegree)
INTEGER, INTENT(IN) :: sourceweights(*), destweights(*)
TYPE(MPI_Info), INTENT(IN) :: info
LOGICAL, INTENT(IN) :: reorder
TYPE(MPI_Comm), INTENT(OUT) :: comm_dist_graph
INTEGER, OPTIONAL, INTENT(OUT) :: ierror
```



```

1 MPI_DIST_GRAPH_CREATE_ADJACENT(COMM_OLD, INDEGREE, SOURCES, SOURCEWEIGHTS,
2     OUTDEGREE, DESTINATIONS, DESTWEIGHTS, INFO, REORDER,
3     COMM_DIST_GRAPH, IERROR)
4     INTEGER COMM_OLD, INDEGREE, SOURCES(*), SOURCEWEIGHTS(*), OUTDEGREE,
5     DESTINATIONS(*), DESTWEIGHTS(*), INFO, COMM_DIST_GRAPH, IERROR
6     LOGICAL REORDER
7
8 {MPI::Distgraphcomm MPI::Intracomm::Dist_graph_create_adjacent(int
9     indegree, const int sources[], const int sourceweights[],
10    int outdegree, const int destinations[],
11    const int destweights[], const MPI::Info& info, bool reorder)
12    const(binding deprecated, see Section 15.2) }
13
14 {MPI::Distgraphcomm
15     MPI::Intracomm::Dist_graph_create_adjacent(int indegree,
16     const int sources[], int outdegree, const int destinations[],
17     const MPI::Info& info, bool reorder) const(binding deprecated, see
18     Section 15.2) }

```

ticket259.
ticket259.
 MPI_DIST_GRAPH_CREATE_ADJACENT returns a handle to a new communicator to which the distributed graph topology information is attached. [Each process passes all information about the edges to its neighbors]Each process passes all information about its incoming and outgoing edges in the virtual distributed graph topology. The calling processes must ensure that each edge of the graph is described in the source and in the destination process with the same weights. If there are multiple edges for a given (source,dest) pair, then the sequence of the weights of these edges does not matter. The complete communication topology is the combination of all edges shown in the `sources` arrays of all processes in `comm_old`, which must be identical to the combination of all edges shown in the `destinations` arrays. Source and destination ranks must be process ranks of `comm_old`. This allows a fully distributed specification of the communication graph. Isolated processes (i.e., processes with no outgoing or incoming edges, that is, processes that have specified `indegree` and `outdegree` as zero and [that]thus do not occur as source or destination rank in the graph specification) are allowed.

The call creates a new communicator `comm_dist_graph` of distributed graph topology type to which topology information has been attached. The number of processes in `comm_dist_graph` is identical to the number of processes in `comm_old`. The call to `MPI_DIST_GRAPH_CREATE_ADJACENT` is collective.

Weights are specified as non-negative integers and can be used to influence the process remapping strategy and other internal MPI optimizations. For instance, approximate count arguments of later communication calls along specific edges could be used as their edge weights. Multiplicity of edges can likewise indicate more intense communication between pairs of processes. However, the exact meaning of edge weights is not specified by the MPI standard and is left to the implementation. In C or Fortran, an application can supply the special value `MPI_UNWEIGHTED` for the weight array to indicate that all edges have the same (effectively no) weight. In C++, this constant does not exist and the weight arguments may be omitted from the argument list. It is erroneous to supply `MPI_UNWEIGHTED`, or in C++ omit the weight arrays, for some but not all processes of `comm_old`. Note that `MPI_UNWEIGHTED` is not a special weight value; rather it is a special value for the total array argument. In C, one would expect it to be `NULL`. In Fortran, `MPI_UNWEIGHTED` is an

object like MPI_BOTTOM (not usable for initialization or assignment). See Section 2.5.4.

The meaning of the info and reorder arguments is defined in the description of the following routine.

MPI_DIST_GRAPH_CREATE(comm_old, n, sources, degrees, destinations, weights, info, reorder, comm_dist_graph)

IN	comm_old	input communicator (handle)	
IN	n	number of source nodes for which this process specifies edges (non-negative integer)	
IN	sources	array containing the n source nodes for which this process specifies edges (array of non-negative integers)	
IN	degrees	array specifying the number of destinations for each source node in the source node array (array of non-negative integers)	
IN	destinations	destination nodes for the source nodes in the source node array (array of non-negative integers)	
IN	weights	weights for source to destination edges (array of non-negative integers)	
IN	info	hints on optimization and interpretation of weights (handle)	
IN	reorder	the process may be reordered (true) or not (false) (logical)	
OUT	comm_dist_graph	communicator with distributed graph topology added (handle)	

```

int MPI_Dist_graph_create(MPI_Comm comm_old, int n, const int sources[],
    const int degrees[], const int destinations[], const
    int weights[], MPI_Info info, int reorder,
    MPI_Comm *comm_dist_graph)
MPI_Dist_graph_create(comm_old, n, sources, degrees, destinations, weights,
    info, reorder, comm_dist_graph, ierror) BIND(C)
    TYPE(MPI_Comm), INTENT(IN) :: comm_old
    INTEGER, INTENT(IN) :: n, sources(n), degrees(n), destinations(*)
    INTEGER, INTENT(IN) :: weights(*)
    TYPE(MPI_Info), INTENT(IN) :: info
    LOGICAL, INTENT(IN) :: reorder
    TYPE(MPI_Comm), INTENT(OUT) :: comm_dist_graph
    INTEGER, OPTIONAL, INTENT(OUT) :: ierror
MPI_DIST_GRAPH_CREATE(COMM_OLD, N, SOURCES, DEGREES, DESTINATIONS, WEIGHTS,
    INFO, REORDER, COMM_DIST_GRAPH, IERROR)
    INTEGER COMM_OLD, N, SOURCES(*), DEGREES(*), DESTINATIONS(*),
    WEIGHTS(*), INFO, COMM_DIST_GRAPH, IERROR
    LOGICAL REORDER

```

```

1 {MPI::Distgraphcomm MPI::Intracomm::Dist_graph_create(int n,
2     const int sources[], const int degrees[], const int
3     destinations[], const int weights[], const MPI::Info& info,
4     bool reorder) const(binding deprecated, see Section 15.2) }
5
6 {MPI::Distgraphcomm MPI::Intracomm::Dist_graph_create(int n,
7     const int sources[], const int degrees[],
8     const int destinations[], const MPI::Info& info, bool reorder)
9     const(binding deprecated, see Section 15.2) }

```

MPI_DIST_GRAPH_CREATE returns a handle to a new communicator to which the distributed graph topology information is attached. Concretely, each process calls the constructor with a set of directed (source,destination) communication edges as described below. Every process passes an array of n source nodes in the `sources` array. For each source node, a non-negative number of destination nodes is specified in the `degrees` array. The destination nodes are stored in the corresponding consecutive segment of the `destinations` array. More precisely, if the i -th node in `sources` is s , this specifies `degrees[i]` edges (s,d) with d of the j -th such edge stored in `destinations[degrees[0]+...+degrees[i-1]+j]`. The weight of this edge is stored in `weights[degrees[0]+...+degrees[i-1]+j]`. Both the `sources` and the `destinations` arrays may contain the same node more than once, and the order in which nodes are listed as destinations or sources is not significant. Similarly, different processes may specify edges with the same source and destination nodes. Source and destination nodes must be process ranks of `comm_old`. Different processes may specify different numbers of source and destination nodes, as well as different source to destination edges. This allows a fully distributed specification of the communication graph. Isolated processes (i.e., processes with no outgoing or incoming edges, that is, processes that do not occur as source or destination node in the graph specification) are allowed.

The call creates a new communicator `comm_dist_graph` of distributed graph topology type to which topology information has been attached. The number of processes in `comm_dist_graph` is identical to the number of processes in `comm_old`. The call to `[MPI_Dist_graph_create]MPI_DIST_GRAPH_CREATE` is collective.

If `reorder = false`, all processes will have the same rank in `comm_dist_graph` as in `comm_old`. If `reorder = true` then the MPI library is free to remap to other processes (of `comm_old`) in order to improve communication on the edges of the communication graph. The weight associated with each edge is a hint to the MPI library about the amount or intensity of communication on that edge, and may be used to compute a “best” reordering.

Weights are specified as non-negative integers and can be used to influence the process remapping strategy and other internal MPI optimizations. For instance, approximate count arguments of later communication calls along specific edges could be used as their edge weights. Multiplicity of edges can likewise indicate more intense communication between pairs of processes. However, the exact meaning of edge weights is not specified by the MPI standard and is left to the implementation. In C or Fortran, an application can supply the special value `MPI_UNWEIGHTED` for the weight array to indicate that all edges have the same (effectively no) weight. In C++, this constant does not exist and the weights argument may be omitted from the argument list. It is erroneous to supply `MPI_UNWEIGHTED`, or in C++ omit the weight arrays, for some but not all processes of `comm_old`. Note that `MPI_UNWEIGHTED` is not a special weight value; rather it is a special value for the total array argument. In C, one would expect it to be `NULL`. In Fortran, `MPI_UNWEIGHTED` is

an object like `MPI_BOTTOM` (not usable for initialization or assignment). See Section 2.5.4

The meaning of the `weights` argument can be influenced by the `info` argument. Info arguments can be used to guide the mapping; possible options include minimizing the maximum number of edges between processes on different SMP nodes, or minimizing the sum of all such edges. An MPI implementation is not obliged to follow specific hints, and it is valid for an MPI implementation not to do any reordering. An MPI implementation may specify more `info` key-value pairs. All processes must specify the same set of key-value `info` pairs.

Advice to implementors. MPI implementations must document any additionally supported key-value `info` pairs. `MPI_INFO_NULL` is always valid, and may indicate the default creation of the distributed graph topology to the MPI library.

An implementation does not explicitly need to construct the topology from its distributed parts. However, all processes can construct the full topology from the distributed specification and use this in a call to `MPI_GRAPH_CREATE` to create the topology. This may serve as a reference implementation of the functionality, and may be acceptable for small communicators. However, a scalable high-quality implementation would save the topology graph in a distributed way. (*End of advice to implementors.*)

Example 7.3 As for Example 7.2, assume there are four processes 0, 1, 2, 3 with the following adjacency matrix and unit edge weights:

process	neighbors
0	1, 3
1	0
2	3
3	0, 2

With `MPI_DIST_GRAPH_CREATE`, this graph could be constructed in many different ways. One way would be that each process specifies its outgoing edges. The arguments per process would be:

process	n	sources	degrees	destinations	weights
0	1	0	2	1,3	1,1
1	1	1	1	0	1
2	1	2	1	3	1
3	1	3	2	0,2	1,1

Another way would be to pass the whole graph on process 0, which could be done with the following arguments per process:

process	n	sources	degrees	destinations	weights
0	4	0,1,2,3	2,1,1,2	1,3,0,3,0,2	1,1,1,1,1,1
1	0	-	-	-	-
2	0	-	-	-	-
3	0	-	-	-	-

In both cases above, the application could supply `MPI_UNWEIGHTED` instead of explic-

1 itly providing identical weights.

2 MPI_DIST_GRAPH_CREATE_ADJACENT could be used to specify this graph using the
3 following arguments:

process	indegree	sources	sourceweights	outdegree	destinations	destweights
0	2	1,3	1,1	2	1,3	1,1
1	1	0	1	1	0	1
2	1	3	1	1	3	1
3	2	0,2	1,1	2	0,2	1,1

11 **Example 7.4** A two-dimensional $P \times Q$ torus where all processes communicate along the
12 dimensions and along the diagonal edges. This cannot be [modelled]modeled with Cartesian
ticket0. 13 topologies, but can easily be captured with MPI_DIST_GRAPH_CREATE as shown in the
14 following code. In this example, the communication along the dimensions is twice as heavy
15 as the communication along the diagonals:

```

16
17 /*
18 Input:      dimensions P, Q
19 Condition: number of processes equal to P*Q; otherwise only
20             ranks smaller than P*Q participate
21 */
22 int rank, x, y;
23 int sources[1], degrees[1];
24 int destinations[8], weights[8];
25 MPI_Comm comm_dist_graph;
26
27 MPI_Comm_rank(MPI_COMM_WORLD, &rank);
28
29 /* get x and y dimension */
30 y=rank/P; x=rank%P;
31
32 /* get my communication partners along x dimension */
33 destinations[0] = P*y+(x+1)%P; weights[0] = 2;
34 destinations[1] = P*y+(P+x-1)%P; weights[1] = 2;
35
36 /* get my communication partners along y dimension */
37 destinations[2] = P*((y+1)%Q)+x; weights[2] = 2;
38 destinations[3] = P*((Q+y-1)%Q)+x; weights[3] = 2;
39
40 /* get my communication partners along diagonals */
41 destinations[4] = P*((y+1)%Q)+(x+1)%P; weights[4] = 1;
42 destinations[5] = P*((Q+y-1)%Q)+(x+1)%P; weights[5] = 1;
43 destinations[6] = P*((y+1)%Q)+(P+x-1)%P; weights[6] = 1;
44 destinations[7] = P*((Q+y-1)%Q)+(P+x-1)%P; weights[7] = 1;
45
46 sources[0] = rank;
47 degrees[0] = 8;
48 MPI_Dist_graph_create(MPI_COMM_WORLD, 1, sources, degrees, destinations,
```

```
weights, MPI_INFO_NULL, 1, &comm_dist_graph);
```

7.5.5 Topology Inquiry Functions

If a topology has been defined with one of the above functions, then the topology information can be looked up using inquiry functions. They all are local calls.

`MPI_TOPO_TEST(comm, status)`

IN	comm	communicator (handle)
OUT	status	topology type of communicator <code>comm</code> (state)

```
int MPI_Topo_test(MPI_Comm comm, int *status)
```

```
MPI_Topo_test(comm, status, ierror) BIND(C)
  TYPE(MPI_Comm), INTENT(IN) :: comm
  INTEGER, INTENT(OUT) :: status
  INTEGER, OPTIONAL, INTENT(OUT) :: ierror
```

```
MPI_TOPO_TEST(COMM, STATUS, IERROR)
  INTEGER COMM, STATUS, IERROR
```

```
{int MPI::Comm::Get_topology() const(binding deprecated, see Section 15.2) }
```

The function `MPI_TOPO_TEST` returns the type of topology that is assigned to a communicator.

The output value `status` is one of the following:

<code>MPI_GRAPH</code>	graph topology
<code>MPI_CART</code>	Cartesian topology
<code>MPI_DIST_GRAPH</code>	distributed graph topology
<code>MPI_UNDEFINED</code>	no topology

`MPI_GRAPHDIMS_GET(comm, nnodes, nedges)`

IN	comm	communicator for group with graph structure (handle)
OUT	nnodes	number of nodes in graph (integer) (same as number of processes in the group)
OUT	nedges	number of edges in graph (integer)

```
int MPI_Graphdims_get(MPI_Comm comm, int *nnodes, int *nedges)
```

```
MPI_Graphdims_get(comm, nnodes, nedges, ierror) BIND(C)
  TYPE(MPI_Comm), INTENT(IN) :: comm
  INTEGER, INTENT(OUT) :: nnodes, nedges
  INTEGER, OPTIONAL, INTENT(OUT) :: ierror
```

```
MPI_GRAPHDIMS_GET(COMM, NNODES, NEDGES, IERROR)
  INTEGER COMM, NNODES, NEDGES, IERROR
```

```
1 {void MPI::Graphcomm::Get_dims(int nnodes[], int nedges[]) const(binding
2 deprecated, see Section 15.2) }
```

3
4 Functions MPI_GRAPHDIMS_GET and MPI_GRAPH_GET retrieve the graph-topology information that was associated with a communicator by MPI_GRAPH_CREATE.

5
6 The information provided by MPI_GRAPHDIMS_GET can be used to dimension the vectors `index` and `edges` correctly for the following call to MPI_GRAPH_GET.

```
9 MPI_GRAPH_GET(comm, maxindex, maxedges, index, edges)
```

10			
11	IN	comm	communicator with graph structure (handle)
12	IN	maxindex	length of vector index in the calling program
13			(integer)
14	IN	maxedges	length of vector edges in the calling program
15			(integer)
16	OUT	index	array of integers containing the graph structure (for
17			details see the definition of MPI_GRAPH_CREATE)
18			
19	OUT	edges	array of integers containing the graph structure
20			

```
21 int MPI_Graph_get(MPI_Comm comm, int maxindex, int maxedges,
22 int [*index]index[], int [*edges]edges[])
```

```
ticket125. 23 MPI_Graph_get(comm, maxindex, maxedges, index, edges, ierror) BIND(C)
ticket125. 24 TYPE(MPI_Comm), INTENT(IN) :: comm
ticket-248T. 25 INTEGER, INTENT(IN) :: maxindex, maxedges
26 INTEGER, INTENT(OUT) :: index(maxindex), edges(maxedges)
27 INTEGER, OPTIONAL, INTENT(OUT) :: ierror
28
```

```
29 MPI_GRAPH_GET(COMM, MAXINDEX, MAXEDGES, INDEX, EDGES, IERROR)
30 INTEGER COMM, MAXINDEX, MAXEDGES, INDEX(*), EDGES(*), IERROR
```

```
31 {void MPI::Graphcomm::Get_topo(int maxindex, int maxedges, int index[],
32 int edges[]) const(binding deprecated, see Section 15.2) }
```

```
35
36 MPI_CARTDIM_GET(comm, ndims)
```

37	IN	comm	communicator with Cartesian structure (handle)
38	OUT	ndims	number of dimensions of the Cartesian structure (in-
39			teger)
40			

```
41
42 int MPI_Cartdim_get(MPI_Comm comm, int *ndims)
```

```
ticket-248T. 43 MPI_Cartdim_get(comm, ndims, ierror) BIND(C)
44 TYPE(MPI_Comm), INTENT(IN) :: comm
45 INTEGER, INTENT(OUT) :: ndims
46 INTEGER, OPTIONAL, INTENT(OUT) :: ierror
47
```

```
48 MPI_CARTDIM_GET(COMM, NDIMS, IERROR)
```

```

INTEGER COMM, NDIMS, IERROR
1
{int MPI::Cartcomm::Get_dim() const(binding deprecated, see Section 15.2) }
2
3
The functions MPI_CARTDIM_GET and MPI_CART_GET return the Cartesian topol-
4
5
6
7
8
9
10
MPI_CART_GET(comm, maxdims, dims, periods, coords)
11
IN      comm      communicator with Cartesian structure (handle)
12
IN      maxdims   length of vectors dims, periods, and coords in the
13
14
15
16
17
18
19
20
21
22
23
24
25
26
27
28
29
30
31
32
33
34
35
36
37
38
39
40
41
42
43
44
45
46
47
48
int MPI_Cart_get(MPI_Comm comm, int maxdims, int [*dims]dims[],
                int [*periods]periods[], int [*coords]coords[])
MPI_Cart_get(comm, maxdims, dims, periods, coords, ierror) BIND(C)
TYPE(MPI_Comm), INTENT(IN) :: comm
INTEGER, INTENT(IN) :: maxdims
INTEGER, INTENT(OUT) :: dims(maxdims), coords(maxdims)
LOGICAL, INTENT(OUT) :: periods(maxdims)
INTEGER, OPTIONAL, INTENT(OUT) :: ierror
MPI_CART_GET(COMM, MAXDIMS, DIMS, PERIODS, COORDS, IERROR)
INTEGER COMM, MAXDIMS, DIMS(*), COORDS(*), IERROR
LOGICAL PERIODS(*)
{void MPI::Cartcomm::Get_topo(int maxdims, int dims[], bool periods[],
                             int coords[]) const(binding deprecated, see Section 15.2) }
MPI_CART_RANK(comm, coords, rank)
IN      comm      communicator with Cartesian structure (handle)
IN      coords    integer array (of size ndims) specifying the Cartesian
43
44
45
46
47
48
OUT     rank      rank of specified process (integer)
int MPI_Cart_rank(MPI_Comm comm, const int [*coords]coords[], int *rank)
MPI_Cart_rank(comm, coords, rank, ierror) BIND(C)

```

```

1     TYPE(MPI_Comm), INTENT(IN) :: comm
2     INTEGER, INTENT(IN) :: coords(*)
3     INTEGER, INTENT(OUT) :: rank
4     INTEGER, OPTIONAL, INTENT(OUT) :: ierror
5
6 MPI_CART_RANK(COMM, COORDS, RANK, IERROR)
7     INTEGER COMM, COORDS(*), RANK, IERROR
8
9 {int MPI::Cartcomm::Get_cart_rank(const int coords[]) const(binding
10     deprecated, see Section 15.2)}

```

For a process group with Cartesian structure, the function `MPI_CART_RANK` translates the logical process coordinates to process ranks as they are used by the point-to-point routines.

For dimension `i` with `periods(i) = true`, if the coordinate, `coords(i)`, is out of range, that is, `coords(i) < 0` or `coords(i) ≥ dims(i)`, it is shifted back to the interval $0 \leq \text{coords}(i) < \text{dims}(i)$ automatically. Out-of-range coordinates are erroneous for non-periodic dimensions.

If `comm` is associated with a zero-dimensional Cartesian topology, `coords` is not significant and 0 is returned in `rank`.

```

21 MPI_CART_COORDS(comm, rank, maxdims, coords)
22
23     IN      comm      communicator with Cartesian structure (handle)
24     IN      rank      rank of a process within group of comm (integer)
25     IN      maxdims   length of vector coords in the calling program (inte-
26     ger)
27
28     OUT     coords    integer array (of size ndims) containing the Cartesian
29     coordinates of specified process (array of integers)

```

```

30
31 int MPI_Cart_coords(MPI_Comm comm, int rank, int maxdims,
32     int [*coords] coords[])

```

```

33 MPI_Cart_coords(comm, rank, maxdims, coords, ierror) BIND(C)
34     TYPE(MPI_Comm), INTENT(IN) :: comm
35     INTEGER, INTENT(IN) :: rank, maxdims
36     INTEGER, INTENT(OUT) :: coords(maxdims)
37     INTEGER, OPTIONAL, INTENT(OUT) :: ierror
38

```

```

39 MPI_CART_COORDS(COMM, RANK, MAXDIMS, COORDS, IERROR)
40     INTEGER COMM, RANK, MAXDIMS, COORDS(*), IERROR

```

```

41 {void MPI::Cartcomm::Get_coords(int rank, int maxdims, int coords[])
42     const(binding deprecated, see Section 15.2)}
43

```

The inverse mapping, rank-to-coordinates translation is provided by `MPI_CART_COORDS`.

If `comm` is associated with a zero-dimensional Cartesian topology, `coords` will be unchanged.

```

MPI_GRAPH_NEIGHBORS_COUNT(comm, rank, nneighbors)
    IN      comm      communicator with graph topology (handle)
    IN      rank      rank of process in group of comm (integer)
    OUT     nneighbors number of neighbors of specified process (integer)

int MPI_Graph_neighbors_count(MPI_Comm comm, int rank, int *nneighbors)

MPI_Graph_neighbors_count(comm, rank, nneighbors, ierror) BIND(C)
    TYPE(MPI_Comm), INTENT(IN) :: comm
    INTEGER, INTENT(IN) :: rank
    INTEGER, INTENT(OUT) :: nneighbors
    INTEGER, OPTIONAL, INTENT(OUT) :: ierror

MPI_GRAPH_NEIGHBORS_COUNT(COMM, RANK, NNEIGHBORS, IERROR)
    INTEGER COMM, RANK, NNEIGHBORS, IERROR

{int MPI::Graphcomm::Get_neighbors_count(int rank) const(binding deprecated,
    see Section 15.2) }

MPI_GRAPH_NEIGHBORS(comm, rank, maxneighbors, neighbors)
    IN      comm      communicator with graph topology (handle)
    IN      rank      rank of process in group of comm (integer)
    IN      maxneighbors size of array neighbors (integer)
    OUT     neighbors  ranks of processes that are neighbors to specified process
                    (array of integer)

int MPI_Graph_neighbors(MPI_Comm comm, int rank, int maxneighbors,
    int [*neighbors]neighbors[])

MPI_Graph_neighbors(comm, rank, maxneighbors, neighbors, ierror) BIND(C)
    TYPE(MPI_Comm), INTENT(IN) :: comm
    INTEGER, INTENT(IN) :: rank, maxneighbors
    INTEGER, INTENT(OUT) :: neighbors(maxneighbors)
    INTEGER, OPTIONAL, INTENT(OUT) :: ierror

MPI_GRAPH_NEIGHBORS(COMM, RANK, MAXNEIGHBORS, NEIGHBORS, IERROR)
    INTEGER COMM, RANK, MAXNEIGHBORS, NEIGHBORS(*), IERROR

{void MPI::Graphcomm::Get_neighbors(int rank, int maxneighbors, int
    neighbors[]) const(binding deprecated, see Section 15.2) }

    MPI_GRAPH_NEIGHBORS_COUNT and MPI_GRAPH_NEIGHBORS provide adjacency
    information for a [general] graph topology. The returned count and array of neighbors for
    the queried rank will both include all neighbors and reflect the same edge ordering as
    was specified by the original call to MPI_GRAPH_CREATE. Specifically,
    MPI_GRAPH_NEIGHBORS_COUNT and MPI_GRAPH_NEIGHBORS will return values based

```

on the original `index` and `edges` array passed to `MPI_GRAPH_CREATE` (assuming that `index[-1]` effectively equals zero):

- The `count` number of neighbors (`nneighbors`) returned from `MPI_GRAPH_NEIGHBORS_COUNT` will be `(index[rank] - index[rank-1])`.
- The `neighbors` array returned from `MPI_GRAPH_NEIGHBORS` will be `edges[index[rank-1]]` through `edges[index[rank]-1]`.

Example 7.5

Assume there are four processes 0, 1, 2, 3 with the following adjacency matrix (note that some neighbors are listed multiple times):

process	neighbors
0	1, 1, 3
1	0, 0
2	3
3	0, 2, 2

Thus, the input arguments to `MPI_GRAPH_CREATE` are:

```
nnodes = 4
index = 3, 5, 6, 9
edges = 1, 1, 3, 0, 0, 3, 0, 2, 2
```

Therefore, calling `MPI_GRAPH_NEIGHBORS_COUNT` and `MPI_GRAPH_NEIGHBORS` for each of the 4 processes will return:

Input rank	Count	Neighbors
0	3	1, 1, 3
1	2	0, 0
2	1	3
3	3	0, 2, 2

Example 7.6

Suppose that `comm` is a communicator with a shuffle-exchange topology. The group has 2^n members. Each process is labeled by a_1, \dots, a_n with $a_i \in \{0, 1\}$, and has three neighbors: $\text{exchange}(a_1, \dots, a_n) = a_1, \dots, a_{n-1}, \bar{a}_n$ ($\bar{a} = 1 - a$), $\text{shuffle}(a_1, \dots, a_n) = a_2, \dots, a_n, a_1$, and $\text{unshuffle}(a_1, \dots, a_n) = a_n, a_1, \dots, a_{n-1}$. The graph adjacency list is illustrated below for $n = 3$.

node	exchange neighbors(1)	shuffle neighbors(2)	unshuffle neighbors(3)
0 (000)	1	0	0
1 (001)	0	2	4
2 (010)	3	4	1
3 (011)	2	6	5
4 (100)	5	1	2
5 (101)	4	3	6
6 (110)	7	5	3
7 (111)	6	7	7

Suppose that the communicator `comm` has this topology associated with it. The following code fragment cycles through the three types of neighbors and performs an appropriate permutation for each.

```

C assume: each process has stored a real number A.
C extract neighborhood information
  CALL MPI_COMM_RANK(comm, myrank, ierr)
  CALL MPI_GRAPH_NEIGHBORS(comm, myrank, 3, neighbors, ierr)
C perform exchange permutation
  CALL MPI_SENDRECV_REPLACE(A, 1, MPI_REAL, neighbors(1), 0,
+   neighbors(1), 0, comm, status, ierr)
C perform shuffle permutation
  CALL MPI_SENDRECV_REPLACE(A, 1, MPI_REAL, neighbors(2), 0,
+   neighbors(3), 0, comm, status, ierr)
C perform unshuffle permutation
  CALL MPI_SENDRECV_REPLACE(A, 1, MPI_REAL, neighbors(3), 0,
+   neighbors(2), 0, comm, status, ierr)

```

`MPI_DIST_GRAPH_NEIGHBORS_COUNT` and `MPI_DIST_GRAPH_NEIGHBORS` provide adjacency information for a distributed graph topology.

`MPI_DIST_GRAPH_NEIGHBORS_COUNT(comm, indegree, outdegree, weighted)`

IN	<code>comm</code>	communicator with distributed graph topology (handle)
OUT	<code>indegree</code>	number of edges into this process (non-negative integer)
OUT	<code>outdegree</code>	number of edges out of this process (non-negative integer)
OUT	<code>weighted</code>	false if <code>MPI_UNWEIGHTED</code> was supplied during creation, true otherwise (logical)

```

int MPI_Dist_graph_neighbors_count(MPI_Comm comm, int *indegree,
  int *outdegree, int *weighted)

```

```

MPI_Dist_graph_neighbors_count(comm, indegree, outdegree, weighted, ierror)
  BIND(C)

```

ticket-248T.

```

1     TYPE(MPI_Comm), INTENT(IN) :: comm
2     INTEGER, INTENT(OUT) :: indegree, outdegree
3     LOGICAL, INTENT(OUT) :: weighted
4     INTEGER, OPTIONAL, INTENT(OUT) :: ierror
5
6 MPI_DIST_GRAPH_NEIGHBORS_COUNT(COMM, INDEGREE, OUTDEGREE, WEIGHTED, IERROR)
7     INTEGER COMM, INDEGREE, OUTDEGREE, IERROR
8     LOGICAL WEIGHTED
9
10 {void MPI::Distgraphcomm::Get_dist_neighbors_count(int rank,
11             int indegree[], int outdegree[], bool& weighted) const(binding
12             deprecated, see Section 15.2) }
13
14 MPI_DIST_GRAPH_NEIGHBORS(comm, maxindegree, sources, sourceweights, maxoutdegree,
15                          destinations, destweights)
16
17     IN      comm      communicator with distributed graph topology (han-
18             dle)
19     IN      maxindegree size of sources and sourceweights arrays (non-negative
20             integer)
21     OUT     sources    processes for which the calling process is a destination
22             (array of non-negative integers)
23     OUT     sourceweights weights of the edges into the calling process (array of
24             non-negative integers)
25
26     IN      maxoutdegree size of destinations and destweights arrays (non-negative
27             integer)
28     OUT     destinations processes for which the calling process is a source (ar-
29             ray of non-negative integers)
30
31     OUT     destweights weights of the edges out of the calling process (array
32             of non-negative integers)
33
34 int MPI_Dist_graph_neighbors(MPI_Comm comm, int maxindegree, int sources[],
35                             int sourceweights[], int maxoutdegree, int destinations[],
36                             int destweights[])
37
38 MPI_Dist_graph_neighbors(comm, maxindegree, sources, sourceweights,
39                          maxoutdegree, destinations, destweights, ierror) BIND(C)
40     TYPE(MPI_Comm), INTENT(IN) :: comm
41     INTEGER, INTENT(IN) :: maxindegree, maxoutdegree
42     INTEGER, INTENT(OUT) :: sources(maxindegree),
43     destinations(maxoutdegree)
44     INTEGER :: sourceweights(*), destweights(*)
45     INTEGER, OPTIONAL, INTENT(OUT) :: ierror
46
47 MPI_DIST_GRAPH_NEIGHBORS(COMM, MAXINDEGREE, SOURCES, SOURCEWEIGHTS,
48                          MAXOUTDEGREE, DESTINATIONS, DESTWEIGHTS, IERROR)
49     INTEGER COMM, MAXINDEGREE, SOURCES(*), SOURCEWEIGHTS(*), MAXOUTDEGREE,

```

ticket229.2.
ticket-248T.

```

DESTINATIONS(*), DESTWEIGHTS(*), IERROR
{void MPI::Distgraphcomm::Get_dist_neighbors(int maxindegree,
      int sources[], int sourceweights[], int maxoutdegree,
      int destinations[], int destweights[]) (binding deprecated, see
      Section 15.2) }

```

These calls are local. The number of edges into and out of the process returned by MPI_DIST_GRAPH_NEIGHBORS_COUNT are the total number of such edges given in the call to MPI_DIST_GRAPH_CREATE_ADJACENT or MPI_DIST_GRAPH_CREATE (potentially by processes other than the calling process in the case of MPI_DIST_GRAPH_CREATE). Multiply defined edges are all counted and returned by MPI_DIST_GRAPH_NEIGHBORS in some order. If MPI_UNWEIGHTED is supplied for sourceweights or destweights or both, or if MPI_UNWEIGHTED was supplied during the construction of the graph then no weight information is returned in that array or those arrays. [The]If the communicator was created with MPI_DIST_GRAPH_CREATE_ADJACENT then for each rank in comm, the order of the values in sources and destinations is identical to the input that was used by the process with the same rank in comm_old in the creation call. If the communicator was created with MPI_DIST_GRAPH_CREATE then the only requirement on the order of values in sources and destinations is that two calls to the routine with same input argument comm will return the same sequence of edges. If maxindegree or maxoutdegree is smaller than the numbers returned by MPI_DIST_GRAPH_NEIGHBOR_COUNT, then only the first part of the full list is returned. [Note, that the order of returned edges does need not to be identical to the order that was provided in the creation of comm for the case that MPI_DIST_GRAPH_CREATE_ADJACENT was used.]

Advice to implementors. Since the query calls are defined to be local, each process needs to store the list of its neighbors with incoming and outgoing edges. Communication is required at the collective MPI_DIST_GRAPH_CREATE call in order to compute the neighbor lists for each process from the distributed graph specification. (*End of advice to implementors.*)

7.5.6 Cartesian Shift Coordinates

If the process topology is a Cartesian structure, an MPI_SENDRECV operation is likely to be used along a coordinate direction to perform a shift of data. As input, MPI_SENDRECV takes the rank of a source process for the receive, and the rank of a destination process for the send. If the function MPI_CART_SHIFT is called for a Cartesian process group, it provides the calling process with the above identifiers, which then can be passed to MPI_SENDRECV. The user specifies the coordinate direction and the size of the step (positive or negative). The function is local.

```

1 MPI_CART_SHIFT(comm, direction, disp, rank_source, rank_dest)
2     IN      comm      communicator with Cartesian structure (handle)
3     IN      direction  coordinate dimension of shift (integer)
4     IN      disp      displacement (> 0: upwards shift, < 0: downwards
5                          shift) (integer)
6     OUT     rank_source rank of source process (integer)
7     OUT     rank_dest  rank of destination process (integer)

```

```

10
11 int MPI_Cart_shift(MPI_Comm comm, int direction, int disp,
12                  int *rank_source, int *rank_dest)

```

```

13 MPI_Cart_shift(comm, direction, disp, rank_source, rank_dest, ierror)
14     BIND(C)
15     TYPE(MPI_Comm), INTENT(IN) :: comm
16     INTEGER, INTENT(IN) :: direction, disp
17     INTEGER, INTENT(OUT) :: rank_source, rank_dest
18     INTEGER, OPTIONAL, INTENT(OUT) :: ierror

```

```

19
20 MPI_CART_SHIFT(COMM, DIRECTION, DISP, RANK_SOURCE, RANK_DEST, IERROR)
21     INTEGER COMM, DIRECTION, DISP, RANK_SOURCE, RANK_DEST, IERROR

```

```

22 {void MPI::Cartcomm::Shift(int direction, int disp, int& rank_source,
23                          int& rank_dest) const(binding deprecated, see Section 15.2) }
24

```

ticket-248T. The `[direction]direction` argument indicates the coordinate dimension to be traversed by the shift. The dimensions are numbered from 0 to `ndims-1`, where `ndims` is the number of dimensions.

Depending on the periodicity of the Cartesian group in the specified coordinate direction, `MPI_CART_SHIFT` provides the identifiers for a circular or an end-off shift. In the case of an end-off shift, the value `MPI_PROC_NULL` may be returned in `rank_source` or `rank_dest`, indicating that the source or the destination for the shift is out of range.

It is erroneous to call `MPI_CART_SHIFT` with a direction that is either negative or greater than or equal to the number of dimensions in the Cartesian communicator. This implies that it is erroneous to call `MPI_CART_SHIFT` with a `comm` that is associated with a zero-dimensional Cartesian topology.

Example 7.7

The communicator, `comm`, has a two-dimensional, periodic, Cartesian topology associated with it. A two-dimensional array of `REALs` is stored one element per process, in variable `A`. One wishes to skew this array, by shifting column `i` (vertically, i.e., along the column) by `i` steps.

```

42     ....
43     C find process rank
44         CALL MPI_COMM_RANK(comm, rank, ierr)
45     C find Cartesian coordinates
46         CALL MPI_CART_COORDS(comm, rank, maxdims, coords, ierr)
47     C compute shift source and destination
48

```

```

    CALL MPI_CART_SHIFT(comm, 0, coords(2), source, dest, ierr)
C skew array
    CALL MPI_SENDRECV_REPLACE(A, 1, MPI_REAL, dest, 0, source, 0, comm,
+                               status, ierr)

```

Advice to users. In Fortran, the dimension indicated by `DIRECTION = i` has `DIMS(i+1)` nodes, where `DIMS` is the array that was used to create the grid. In C, the dimension indicated by `direction = i` is the dimension specified by `dims[i]`. (*End of advice to users.*)

7.5.7 Partitioning of Cartesian [s]Structures

`MPI_CART_SUB(comm, remain_dims, newcomm)`

IN	comm	communicator with Cartesian structure (handle)
IN	remain_dims	the <i>i</i> -th entry of <code>remain_dims</code> specifies whether the <i>i</i> -th dimension is kept in the subgrid (<code>true</code>) or is dropped (<code>false</code>) (logical vector)
OUT	newcomm	communicator containing the subgrid that includes the calling process (handle)

```

int MPI_Cart_sub(MPI_Comm comm, const int [*remain_dims]remain_dims[],
                MPI_Comm *newcomm)

```

```

MPI_Cart_sub(comm, remain_dims, newcomm, ierror) BIND(C)
  TYPE(MPI_Comm), INTENT(IN) :: comm
  LOGICAL, INTENT(IN) :: remain_dims(*)
  TYPE(MPI_Comm), INTENT(OUT) :: newcomm
  INTEGER, OPTIONAL, INTENT(OUT) :: ierror

```

```

MPI_CART_SUB(COMM, REMAIN_DIMS, NEWCOMM, IERROR)
  INTEGER COMM, NEWCOMM, IERROR
  LOGICAL REMAIN_DIMS(*)

```

```

{MPI::Cartcomm MPI::Cartcomm::Sub(const bool remain_dims[]) const(binding
  deprecated, see Section 15.2) }

```

If a Cartesian topology has been created with `MPI_CART_CREATE`, the function `MPI_CART_SUB` can be used to partition the communicator group into subgroups that form lower-dimensional Cartesian subgrids, and to build for each subgroup a communicator with the associated subgrid Cartesian topology. If all entries in `remain_dims` are false or `comm` is already associated with a zero-dimensional Cartesian topology then `newcomm` is associated with a zero-dimensional Cartesian topology. (This function is closely related to `MPI_COMM_SPLIT`.)

Example 7.8

Assume that `MPI_CART_CREATE(..., comm)` has defined a $(2 \times 3 \times 4)$ grid. Let `remain_dims = (true, false, true)`. Then a call to,

```

MPI_CART_SUB(comm, remain_dims, comm_new),

```

will create three communicators each with eight processes in a 2×4 Cartesian topology. If `remain_dims = (false, false, true)` then the call to `MPI_CART_SUB(comm, remain_dims, comm_new)` will create six non-overlapping communicators, each with four processes, in a one-dimensional Cartesian topology.

7.5.8 Low-Level Topology Functions

The two additional functions introduced in this section can be used to implement all other topology functions. In general they will not be called by the user directly, unless he or she is creating additional virtual topology capability other than that provided by MPI. **The two calls are both local.**

`MPI_CART_MAP(comm, ndims, dims, periods, newrank)`

IN	<code>comm</code>	input communicator (handle)
IN	<code>ndims</code>	number of dimensions of Cartesian structure (integer)
IN	<code>dims</code>	integer array of size <code>ndims</code> specifying the number of processes in each coordinate direction
IN	<code>periods</code>	logical array of size <code>ndims</code> specifying the periodicity specification in each coordinate direction
OUT	<code>newrank</code>	reordered rank of the calling process; MPI_UNDEFINED if calling process does not belong to grid (integer)

```
int MPI_Cart_map(MPI_Comm comm, int ndims, const int [*dims]dims[], const
                int [*periods]periods[], int *newrank)
```

```
MPI_Cart_map(comm, ndims, dims, periods, newrank, ierror) BIND(C)
```

```
TYPE(MPI_Comm), INTENT(IN) :: comm
INTEGER, INTENT(IN) :: ndims, dims(ndims)
LOGICAL, INTENT(IN) :: periods(ndims)
INTEGER, INTENT(OUT) :: newrank
INTEGER, OPTIONAL, INTENT(OUT) :: ierror
```

```
MPI_CART_MAP(COMM, NDIMS, DIMS, PERIODS, NEWRANK, IERROR)
```

```
INTEGER COMM, NDIMS, DIMS(*), NEWRANK, IERROR
LOGICAL PERIODS(*)
```

```
{int MPI::Cartcomm::Map(int ndims, const int dims[], const bool periods[])
    const(binding deprecated, see Section 15.2) }
```

`MPI_CART_MAP` computes an “optimal” placement for the calling process on the physical machine. A possible implementation of this function is to always return the rank of the calling process, that is, not to perform any reordering.

Advice to implementors. The function `MPI_CART_CREATE(comm, ndims, dims, periods, reorder, comm_cart)`, with `reorder = true` can be implemented by calling `MPI_CART_MAP(comm, ndims, dims, periods, newrank)`, then calling `MPI_COMM_SPLIT(comm, color, key, comm_cart)`, with `color = 0` if `newrank \neq`

MPI_UNDEFINED, color = MPI_UNDEFINED otherwise, and key = newrank. If ndims is zero then a zero-dimensional Cartesian topology is created.

The function MPI_CART_SUB(comm, remain_dims, comm_new) can be implemented by a call to MPI_COMM_SPLIT(comm, color, key, comm_new), using a single number encoding of the lost dimensions as color and a single number encoding of the preserved dimensions as key.

All other Cartesian topology functions can be implemented locally, using the topology information that is cached with the communicator. (*End of advice to implementors.*)

The corresponding [new] function for [general] graph structures is as follows.

MPI_GRAPH_MAP(comm, nnodes, index, edges, newrank)

IN	comm	input communicator (handle)
IN	nnodes	number of graph nodes (integer)
IN	index	integer array specifying the graph structure, see MPI_GRAPH_CREATE
IN	edges	integer array specifying the graph structure
OUT	newrank	reordered rank of the calling process; MPI_UNDEFINED if the calling process does not belong to graph (integer)

```
int MPI_Graph_map(MPI_Comm comm, int nnodes, const int [*index]index[],
                 const int [*edges]edges[], int *newrank)
```

```
MPI_Graph_map(comm, nnodes, index, edges, newrank, ierror) BIND(C)
  TYPE(MPI_Comm), INTENT(IN) :: comm
  INTEGER, INTENT(IN) :: nnodes, index(nnodes), edges(*)
  INTEGER, INTENT(OUT) :: newrank
  INTEGER, OPTIONAL, INTENT(OUT) :: ierror
```

```
MPI_GRAPH_MAP(COMM, NNODES, INDEX, EDGES, NEWRANK, IERROR)
  INTEGER COMM, NNODES, INDEX(*), EDGES(*), NEWRANK, IERROR
```

```
{int MPI::Graphcomm::Map(int nnodes, const int index[], const int edges[])
  const(binding deprecated, see Section 15.2) }
```

Advice to implementors. The function MPI_GRAPH_CREATE(comm, nnodes, index, edges, reorder, comm_graph), with reorder = true can be implemented by calling MPI_GRAPH_MAP(comm, nnodes, index, edges, newrank), then calling MPI_COMM_SPLIT(comm, color, key, comm_graph), with color = 0 if newrank ≠ MPI_UNDEFINED, color = MPI_UNDEFINED otherwise, and key = newrank.

All other graph topology functions can be implemented locally, using the topology information that is cached with the communicator. (*End of advice to implementors.*)

7.6 Neighborhood Collective Communication on Process Topologies

MPI process topologies specify a communication graph, but they implement no communication function themselves. Many applications require sparse nearest neighbor communications that can be expressed as graph topologies. We now describe several collective operations that perform communication along the edges of a process topology. All of these functions are collective; i.e., they must be called by all processes in the specified communicator. See Section 5 on page 151 for an overview of other dense (global) collective communication operations and the semantics of collective operations.

If the graph was created with `MPI_DIST_GRAPH_CREATE_ADJACENT` with sources and destinations containing 0, ..., n-1, where n is the number of processes in the group of `comm_old` (i.e., the graph is fully connected and also includes an edge from each node to itself), then the sparse neighborhood communication routine performs the same data exchange as the corresponding dense (fully-connected) collective operation. In the case of a Cartesian communicator, only nearest neighbor communication is provided, corresponding to `rank_source` and `rank_dest` in `MPI_CART_SHIFT` with input `disp=1`.

Rationale. Neighborhood collective communications enable communication on a process topology. This high-level specification of data exchange among neighboring processes enables optimizations in the MPI library because the communication pattern is known statically (the topology). Thus, the implementation can compute optimized message schedules during creation of the topology [35]. This functionality can significantly simplify the implementation of neighbor exchanges [31]. (*End of rationale.*)

For a distributed graph topology, created with `MPI_DIST_GRAPH_CREATE`, the sequence of neighbors in the send and receive buffers at each process is defined as the sequence returned by `MPI_DIST_GRAPH_NEIGHBORS` for destinations and sources, respectively. For a general graph topology, created with `MPI_GRAPH_CREATE`, the order of neighbors in the send and receive buffers is defined as the sequence of neighbors as returned by `MPI_GRAPH_NEIGHBORS`. Note that general graph topologies should generally be replaced by the distributed graph topologies.

For a Cartesian topology, created with `MPI_CART_CREATE`, the sequence of neighbors in the send and receive buffers at each process is defined by order of the dimensions, first the neighbor in the negative direction and then in the positive direction with displacement 1. The numbers of sources and destinations in the communication routines are `2*ndims` with `ndims` defined in `MPI_CART_CREATE`. If a neighbor does not exist, i.e., at the border of a Cartesian topology in the case of a non-periodic virtual grid dimension (i.e., `periods[...] == false`), then this neighbor is defined to be `MPI_PROC_NULL`.

If a neighbor in any of the functions is `MPI_PROC_NULL`, then the neighborhood collective communication behaves like a point-to-point communication with `MPI_PROC_NULL` in this direction. That is, the buffer is still part of the sequence of neighbors but it is neither communicated nor updated.

7.6.1 Neighborhood Gather

In this function, each process i gathers data items from each process j if an edge (j, i) exists in the topology graph, and each process i sends the same data items to all processes j where an edge (i, j) exists. The send buffer is sent to each neighboring process and the l -th block in the receive buffer is received from the l -th neighbor.

```

MPI_NEIGHBOR_ALLGATHER(sendbuf, sendcount, sendtype, recvbuf, recvcount, recvtype,
                        comm)
    IN      sendbuf      starting address of send buffer (choice)
    IN      sendcount    number of elements sent to each neighbor (non-negative
                        integer)
    IN      sendtype     data type of send buffer elements (handle)
    OUT     recvbuf      starting address of receive buffer (choice)
    IN      recvcount    number of elements received from each neighbor (non-
                        negative integer)
    IN      recvtype     data type of receive buffer elements (handle)
    IN      comm         communicator with topology structure (handle)

int MPI_Neighbor_allgather(const void* sendbuf, int sendcount, MPI_Datatype
                           sendtype, void* recvbuf, int recvcount, MPI_Datatype recvtype,
                           MPI_Comm comm)
MPI_Neighbor_allgather(sendbuf, sendcount, sendtype, recvbuf, recvcount,
                       recvtype, comm, ierror) BIND(C)
    TYPE(*), DIMENSION(..), INTENT(IN) :: sendbuf
    TYPE(*), DIMENSION(..) :: recvbuf
    INTEGER, INTENT(IN) :: sendcount, recvcount
    TYPE(MPI_Datatype), INTENT(IN) :: sendtype, recvtype
    TYPE(MPI_Comm), INTENT(IN) :: comm
    INTEGER, OPTIONAL, INTENT(OUT) :: ierror

MPI_NEIGHBOR_ALLGATHER(SENDBUF, SENDCOUNT, SENDTYPE, RECVBUF, RECVCOUNT,
                       RECVTYPE, COMM, IERROR)
    <type> SENDBUF(*), RECVBUF(*)
    INTEGER SENDCOUNT, SENDTYPE, RECVCOUNT, RECVTYPE, COMM, IERROR

    This function supports Cartesian communicators, graph communicators, and distributed
    graph communicators as described in Section 7.6 on page 330. If comm is a distributed graph
    communicator, the outcome is as if each process executed sends to each of its outgoing
    neighbors and receives from each of its incoming neighbors:

MPI_Dist_graph_neighbors_count(comm,&indegree,&outdegree,&weighted);
int *srcs=(int*)malloc(indegree*sizeof(int));
int *dsts=(int*)malloc(outdegree*sizeof(int));
MPI_Dist_graph_neighbors(comm,indegree,srcs,MPI_UNWEIGHTED,
                        outdegree,dsts,MPI_UNWEIGHTED);
int k,l;

for(k=0; k<outdegree; ++k)
    MPI_Isend(sendbuf,sendcount,sendtype,dsts[k],...);

for(l=0; l<indegree; ++l)
    MPI_Irecv(recvbuf+l*recvcount*extent(recvtype),recvcount,recvtype,

```

```

1         srcs[1],...);
2
3 MPI_Waitall(...);
4

```

Figure 7.6.1 shows the neighborhood gather communication of one process with outgoing neighbors $d_0 \dots d_3$ and incoming neighbors $s_0 \dots s_5$. The process will send its `sendbuf` to all four destinations (outgoing neighbors) and it will receive the contribution from all six sources (incoming neighbors) into separate locations of its receive buffer.

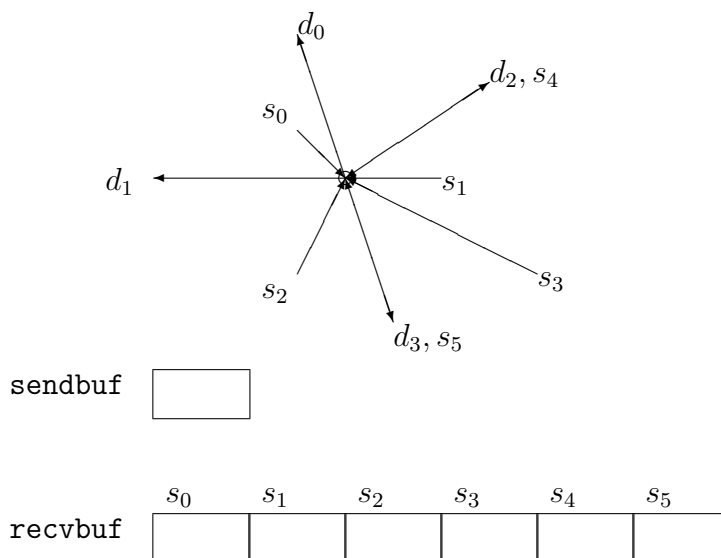

All arguments are significant on all processes and the argument `comm` must have identical values on all processes.

The type signature associated with `sendcount`, `sendtype`, at a process must be equal to the type signature associated with `recvcount`, `recvtype` at all other processes. This implies that the amount of data sent must be equal to the amount of data received, pairwise between every pair of communicating processes. Distinct type maps between sender and receiver are still allowed.

Rationale. For optimization reasons, the same type signature is required independently of whether the topology graph is connected or not. (*End of rationale.*)

The “in place” option is not meaningful for this operation.

The vector variant of `MPI_NEIGHBOR_ALLGATHER` allows one to gather different numbers of elements from each neighbor.

```

MPI_NEIGHBOR_ALLGATHERV(sendbuf, sendcount, sendtype, recvbuf, recvcnts, displs,
                        recvtype, comm)
1
2
3
4
5
6
7
8
9
10
11
12
13
14
15
16
17
18
19
int MPI_Neighbor_allgatherv(const void* sendbuf, int sendcount,
                           MPI_Datatype sendtype, void* recvbuf, const int recvcnts[],
                           const int displs[], MPI_Datatype recvtype, MPI_Comm comm)
20 ticket140.
21 ticket140.
22 ticket140.
23 ticket-248T.
MPI_Neighbor_allgatherv(sendbuf, sendcount, sendtype, recvbuf, recvcnts,
                        displs, recvtype, comm, ierror) BIND(C)
24
25
26
27
28
29
30
31
MPI_NEIGHBOR_ALLGATHERV(SENDBUF, SENDCOUNT, SENDTYPE, RECVBUF, RECVCOUNTS,
                        DISPLS, RECVTYPE, COMM, IERROR)
32
33
34
35
36
37
38
39
40
41
42
43
44
45
46
47
48

```

This function supports Cartesian communicators, graph communicators, and distributed graph communicators as described in Section 7.6 on page 330. If `comm` is a distributed graph communicator, the outcome is as if each process executed sends to each of its outgoing neighbors and receives from each of its incoming neighbors:

```

MPI_Dist_graph_neighbors_count(comm,&indegree,&outdegree,&weighted);
int *srcs=(int*)malloc(indegree*sizeof(int));
int *dsts=(int*)malloc(outdegree*sizeof(int));
MPI_Dist_graph_neighbors(comm,indegree,srcs,MPI_UNWEIGHTED,
                        outdegree,dsts,MPI_UNWEIGHTED);
int k,l;

```

```

1
2 for(k=0; k<outdegree; ++k)
3     MPI_Isend(sendbuf, sendcount, sendtype, dsts[k], ...);
4
5 for(l=0; l<indegree; ++l)
6     MPI_Irecv(recvbuf+displs[l]*extent(recvtype), recvcnts[l], recvtype,
7             srcs[l], ...);
8
9 MPI_Waitall(...);

```

The type signature associated with `sendcount`, `sendtype`, at process j must be equal to the type signature associated with `recvcnts[l]`, `recvtype` at any other process with `srcs[l]==j`. This implies that the amount of data sent must be equal to the amount of data received, pairwise between every pair of communicating processes. Distinct type maps between sender and receiver are still allowed. The data received from the l -th neighbor is placed into `recvbuf` beginning at offset `displs[l]` elements (in terms of the `recvtype`).

The “in place” option is not meaningful for this operation.

All arguments are significant on all processes and the argument `comm` must have identical values on all processes.

7.6.2 Neighbor Alltoall

In this function, each process i receives data items from each process j if an edge (j, i) exists in the topology graph or Cartesian topology. Similarly, each process i sends data items to all processes j where an edge (i, j) exists. This call is more general than `MPI_NEIGHBOR_ALLGATHER` in that different data items can be sent to each neighbor. The k -th block in send buffer is sent to the k -th neighboring process and the l -th block in the receive buffer is received from the l -th neighbor.

```
MPI_NEIGHBOR_ALLTOALL(sendbuf, sendcount, sendtype, recvbuf, recvcnt, recvtype, comm)
```

IN	<code>sendbuf</code>	starting address of send buffer (choice)
IN	<code>sendcount</code>	number of elements sent to each neighbor (non-negative integer)
IN	<code>sendtype</code>	data type of send buffer elements (handle)
OUT	<code>recvbuf</code>	starting address of receive buffer (choice)
IN	<code>recvcnt</code>	number of elements received from each neighbor (non-negative integer)
IN	<code>recvtype</code>	data type of receive buffer elements (handle)
IN	<code>comm</code>	communicator with topology structure (handle)

```

ticket140. int MPI_Neighbor_alltoall(const void* sendbuf, int sendcount, MPI_Datatype
46             sendtype, void* recvbuf, int recvcnt, MPI_Datatype recvtype,
47             MPI_Comm comm)

```

ticket-248T.

```

MPI_Neighbor_alltoall(sendbuf, sendcount, sendtype, recvbuf, recvcount,
                      recvtype, comm, ierror) BIND(C)
TYPE(*), DIMENSION(..), INTENT(IN) :: sendbuf
TYPE(*), DIMENSION(..) :: recvbuf
INTEGER, INTENT(IN) :: sendcount, recvcount
TYPE(MPI_Datatype), INTENT(IN) :: sendtype, recvtype
TYPE(MPI_Comm), INTENT(IN) :: comm
INTEGER, OPTIONAL, INTENT(OUT) :: ierror
MPI_NEIGHBOR_ALLTOALL(SENDBUF, SENDCOUNT, SENDTYPE, RECVBUF, RECVCOUNT,
                      RECVTYPE, COMM, IERROR)
<type> SENDBUF(*), RECVBUF(*)
INTEGER SENDCOUNT, SENDTYPE, RECVCOUNT, RECVTYPE, COMM, IERROR

```

This function supports Cartesian communicators, graph communicators, and distributed graph communicators as described in Section 7.6 on page 330. If `comm` is a distributed graph communicator, the outcome is as if each process executed sends to each of its outgoing neighbors and receives from each of its incoming neighbors:

```

MPI_Dist_graph_neighbors_count(comm,&indegree,&outdegree,&weighted);
int *srcs=(int*)malloc(indegree*sizeof(int));
int *dsts=(int*)malloc(outdegree*sizeof(int));
MPI_Dist_graph_neighbors(comm,indegree,srcs,MPI_UNWEIGHTED,
                        outdegree,dsts,MPI_UNWEIGHTED);
int k,l;
for(k=0; k<outdegree; ++k)
    MPI_Isend(sendbuf+k*sendcount*extent(sendtype),sendcount,sendtype,
              dsts[k],...);
for(l=0; l<indegree; ++l)
    MPI_Irecv(recvbuf+l*recvcount*extent(recvtype),recvcount,recvtype,
              srcs[l],...);
MPI_Waitall(...);

```

The type signature associated with `sendcount`, `sendtype`, at a process must be equal to the type signature associated with `recvcount`, `recvtype` at any other process. This implies that the amount of data sent must be equal to the amount of data received, pairwise between every pair of communicating processes. Distinct type maps between sender and receiver are still allowed.

The “in place” option is not meaningful for this operation.

All arguments are significant on all processes and the argument `comm` must have identical values on all processes.

The vector variant of `MPI_NEIGHBOR_ALLTOALL` allows sending/receiving different numbers of elements to and from each neighbor.

```

1 MPI_NEIGHBOR_ALLTOALLV(sendbuf, sendcounts, sdispls, sendtype, recvbuf, recvcoun
2     rdispls, recvtype, comm)
3
4     IN     sendbuf     starting address of send buffer (choice)
5
6     IN     sendcounts  non-negative integer array (of length outdegree) speci-
7     fying the number of elements to send to each neighbor
8
9     IN     sdispls     integer array (of length outdegree). Entry j specifies
10    the displacement (relative to sendbuf) from which to
11    send the outgoing data to neighbor j
12
13    IN     sendtype    data type of send buffer elements (handle)
14
15    OUT    recvbuf     starting address of receive buffer (choice)
16
17    IN     recvcoun
18    ts               non-negative integer array (of length indegree) speci-
19    fying the number of elements that are received from
20    each neighbor
21
22    IN     rdispls     integer array (of length indegree). Entry i specifies
23    the displacement (relative to recvbuf) at which to place
24    the incoming data from neighbor i
25
26    IN     recvtype    data type of receive buffer elements (handle)
27
28    IN     comm        communicator with topology structure (handle)

```

```

ticket140. 23 int MPI_Neighbor_alltoallv(const void* sendbuf, const int sendcounts[],
ticket140. 24     const int sdispls[], MPI_Datatype sendtype, void* recvbuf,
ticket140. 25     const int recvcoun
ticket140. 26     ts[], const int rdispls[], MPI_Datatype
ticket140. 27     recvtype, MPI_Comm comm)

```

```

ticket-248T. 28 MPI_Neighbor_alltoallv(sendbuf, sendcounts, sdispls, sendtype, recvbuf,
29     recvcoun
30     ts, rdispls, recvtype, comm, ierror) BIND(C)
31     TYPE(*), DIMENSION(..), INTENT(IN) :: sendbuf
32     TYPE(*), DIMENSION(..) :: recvbuf
33     INTEGER, INTENT(IN) :: sendcounts(*), sdispls(*), recvcoun
34     ts(*),
35     rdispls(*)
36     TYPE(MPI_Datatype), INTENT(IN) :: sendtype, recvtype
37     TYPE(MPI_Comm), INTENT(IN) :: comm
38     INTEGER, OPTIONAL, INTENT(OUT) :: ierror
39
40 MPI_NEIGHBOR_ALLTOALLV(SENDBUF, SENDCOUNTS, SDISPLS, SENDTYPE, RECVBUF,
41     RECVCOUNTS, RDISPLS, RECVTYPE, COMM, IERROR)
42
43     <type> SENDBUF(*), RECVBUF(*)
44     INTEGER SENDCOUNTS(*), SDISPLS(*), SENDTYPE, RECVCOUNTS(*), RDISPLS(*),
45     RECVTYPE, COMM, IERROR

```

This function supports Cartesian communicators, graph communicators, and distributed graph communicators as described in Section 7.6 on page 330. If `comm` is a distributed graph communicator, the outcome is as if each process executed sends to each of its outgoing neighbors and receives from each of its incoming neighbors:

```

47 MPI_Dist_graph_neighbors_count(comm,&indegree,&outdegree,&weighted);
48

```



```

int *srcs=(int*)malloc(indegree*sizeof(int));           1
int *dsts=(int*)malloc(outdegree*sizeof(int));         2
MPI_Dist_graph_neighbors(comm,indegree,srcs,MPI_UNWEIGHTED, 3
                        outdegree,dsts,MPI_UNWEIGHTED); 4
int k,l;                                               5
                                                       6
for(k=0; k<outdegree; ++k)                             7
    MPI_Isend(sendbuf+sdispls[k]*extent(sendtype),sendcounts[k],sendtype, 8
              dsts[k],...);                             9
                                                       10
for(l=0; l<indegree; ++l)                             11
    MPI_Irecv(recvbuf+rdispls[l]*extent(recvtype),recvcounts[l],recvtype, 12
              srcs[l],...);                             13
                                                       14
MPI_Waitall(...);                                     15
                                                       16

```

The type signature associated with `sendcounts[k]`, `sendtype` with `dsts[k]==j` at process `i` must be equal to the type signature associated with `recvcounts[l]`, `recvtype` with `srcs[l]==i` at process `j`. This implies that the amount of data sent must be equal to the amount of data received, pairwise between every pair of communicating processes. Distinct type maps between sender and receiver are still allowed. The data in the `sendbuf` beginning at offset `sdispls[k]` elements (in terms of the `sendtype`) is sent to the `k`-th outgoing neighbor. The data received from the `l`-th incoming neighbor is placed into `recvbuf` beginning at offset `rdispls[l]` elements (in terms of the `recvtype`).

The “in place” option is not meaningful for this operation.

All arguments are significant on all processes and the argument `comm` must have identical values on all processes.

`MPI_NEIGHBOR_ALLTOALLW` allows one to send and receive with different datatypes to and from each neighbor.

```

1 MPI_NEIGHBOR_ALLTOALLW(sendbuf, sendcounts, sdispls, sendtypes, recvbuf, recvcounts,
2   rdispls, recvtypes, comm)
3
4   IN      sendbuf      starting address of send buffer (choice)
5
6   IN      sendcounts   non-negative integer array (of length outdegree) speci-
7   fying the number of elements to send to each neighbor
8
9   IN      sdispls      integer array (of length outdegree). Entry j specifies
10     the displacement in bytes (relative to sendbuf) from
11     which to take the outgoing data destined for neighbor
12     j (array of integers)
13
14   IN      sendtypes    array of datatypes (of length outdegree). Entry j spec-
15     ifies the type of data to send to neighbor j (array of
16     handles)
17
18   OUT     recvbuf      starting address of receive buffer (choice)
19
20   IN      recvcounts   non-negative integer array (of length indegree) speci-
21     fying the number of elements that are received from
22     each neighbor
23
24   IN      rdispls      integer array (of length indegree). Entry i specifies
25     the displacement in bytes (relative to recvbuf) at which
26     to place the incoming data from neighbor i (array of
27     integers)
28
29   IN      recvtypes    array of datatypes (of length indegree). Entry i spec-
30     ifies the type of data received from neighbor i (array
31     of handles)
32
33   IN      comm         communicator with topology structure (handle)

```

```

ticket140. 29 int MPI_Neighbor_alltoallw(const void* sendbuf, const int sendcounts[],
ticket140. 30     const [int]MPI_Aint sdispls[], const MPI_Datatype sendtypes[],
ticket140. 31     void* recvbuf, const int recvcounts[], const [int]MPI_Aint
ticket299. 32     rdispls[], const MPI_Datatype recvtypes[], MPI_Comm comm)

```

```

ticket140. 33 MPI_Neighbor_alltoallw(sendbuf, sendcounts, sdispls, sendtypes, recvbuf,
ticket140. 34     recvcounts, rdispls, recvtypes, comm, ierror) BIND(C)
ticket140. 35     TYPE(*), DIMENSION(..), INTENT(IN) :: sendbuf
ticket299. 36     TYPE(*), DIMENSION(..) :: recvbuf
ticket140. 37     INTEGER, INTENT(IN) :: sendcounts(*), recvcounts(*)
ticket-248T. 38     INTEGER(KIND=MPI_ADDRESS_KIND), INTENT(IN) :: sdispls(*), rdispls(*)
39     TYPE(MPI_Datatype), INTENT(IN) :: sendtypes(*), recvtypes(*)
40     TYPE(MPI_Comm), INTENT(IN) :: comm
41     INTEGER, OPTIONAL, INTENT(OUT) :: ierror

```

```

43 MPI_NEIGHBOR_ALLTOALLW(SENDBUF, SENDCOUNTS, SDISPLS, SENDTYPES, RECVBUF,
44     RECVCOUNTS, RDISPLS, RECVTYPES, COMM, IERROR)
45 <type> SENDBUF(*), RECVBUF(*)
46 INTEGER(KIND=MPI_ADDRESS_KIND) SDISPLS(*), RDISPLS(*)
47 INTEGER SENDCOUNTS(*), SENDTYPES(*), RECVCOUNTS(*), RECVTYPES(*), COMM,
48 IERROR

```

This function supports Cartesian communicators, graph communicators, and distributed graph communicators as described in Section 7.6 on page 330. If `comm` is a distributed graph communicator, the outcome is as if each process executed sends to each of its outgoing neighbors and receives from each of its incoming neighbors:

```

MPI_Dist_graph_neighbors_count(comm,&indegree,&outdegree,&weighted);
int *srcs=(int*)malloc(indegree*sizeof(int));
int *dsts=(int*)malloc(outdegree*sizeof(int));
MPI_Dist_graph_neighbors(comm,indegree,srcs,MPI_UNWEIGHTED,
                        outdegree,dsts,MPI_UNWEIGHTED);

int k,l;

for(k=0; k<outdegree; ++k)
    MPI_Isend(sendbuf+sdispls[k],sendcounts[k], sendtypes[k],dsts[k],...);

for(l=0; l<indegree; ++l)
    MPI_Irecv(recvbuf+rdispls[l],recvcounts[l], recvtypes[l],srcs[l],...);

MPI_Waitall(...);

```

The type signature associated with `sendcounts[k]`, `sendtypes[k]` with `dsts[k]==j` at process `i` must be equal to the type signature associated with `recvcounts[l]`, `recvtypes[l]` with `srcs[l]==i` at process `j`. This implies that the amount of data sent must be equal to the amount of data received, pairwise between every pair of communicating processes. Distinct type maps between sender and receiver are still allowed.

The “in place” option is not meaningful for this operation.

All arguments are significant on all processes and the argument `comm` must have identical values on all processes.

7.7 Nonblocking Neighborhood Communication on Process Topologies

Nonblocking variants of the neighborhood collective operations allow relaxed synchronization and overlapping of computation and communication. The semantics are similar to nonblocking collective operations as described in Section 5.12.

7.7.1 Nonblocking Neighborhood Gather

```

1
2
3
4 MPI_INEIGHBOR_ALLGATHER(sendbuf, sendcount, sendtype, recvbuf, recvcount, recvtype,
5     comm, request)
6
7     IN     sendbuf     starting address of send buffer (choice)
8     IN     sendcount   number of elements sent to each neighbor (non-negative
9     integer)
10    IN     sendtype    data type of send buffer elements (handle)
11    OUT    recvbuf     starting address of receive buffer (choice)
12    IN     recvcount   number of elements received from each neighbor (non-
13    negative integer)
14
15    IN     recvtype    data type of receive buffer elements (handle)
16    IN     comm        communicator with topology structure (handle)
17    OUT    request     communication request (handle)
18
19

```

```

ticket140. 20 int MPI_Ineighbor_allgather(const void* sendbuf, int sendcount,
21     MPI_Datatype sendtype, void* recvbuf, int recvcount,
22     MPI_Datatype recvtype, MPI_Comm comm, MPI_Request *request)
ticket-248T. 23

```

```

24 MPI_Ineighbor_allgather(sendbuf, sendcount, sendtype, recvbuf, recvcount,
25     recvtype, comm, request, ierror) BIND(C)
26     TYPE(*), DIMENSION(..), INTENT(IN), ASYNCHRONOUS :: sendbuf
27     TYPE(*), DIMENSION(..), ASYNCHRONOUS :: recvbuf
28     INTEGER, INTENT(IN) :: sendcount, recvcount
29     TYPE(MPI_Datatype), INTENT(IN) :: sendtype, recvtype
30     TYPE(MPI_Comm), INTENT(IN) :: comm
31     TYPE(MPI_Request), INTENT(OUT) :: request
32     INTEGER, OPTIONAL, INTENT(OUT) :: ierror
33
34 MPI_INEIGHBOR_ALLGATHER(SENDBUF, SENDCOUNT, SENDTYPE, RECVBUF, REVCOUNT,
35     RECVTYPE, COMM, REQUEST, IERROR)
36     <type> SENDBUF(*), RECVBUF(*)
37     INTEGER SENDCOUNT, SENDTYPE, REVCOUNT, RECVTYPE, COMM, REQUEST, IERROR
38

```

This call starts a nonblocking variant of MPI_NEIGHBOR_ALLGATHER.

<code>MPI_INEIGHBOR_ALLGATHERV(sendbuf, sendcount, sendtype, recvbuf, recvcunts, displ,</code>			1
<code>recvtype, comm, request)</code>			2
IN	<code>sendbuf</code>	starting address of send buffer (choice)	3
			4
IN	<code>sendcount</code>	number of elements sent to each neighbor (non-negative integer)	5
			6
IN	<code>sendtype</code>	data type of send buffer elements (handle)	7
			8
OUT	<code>recvbuf</code>	starting address of receive buffer (choice)	9
			10
IN	<code>recvcunts</code>	non-negative integer array (of length indegree) containing the number of elements that are received from each neighbor	11
			12
IN	<code>displs</code>	integer array (of length indegree). Entry <code>i</code> specifies the displacement (relative to <code>recvbuf</code>) at which to place the incoming data from neighbor <code>i</code>	13
			14
			15
IN	<code>recvtype</code>	data type of receive buffer elements (handle)	16
			17
IN	<code>comm</code>	communicator with topology structure (handle)	18
			19
OUT	<code>request</code>	communication request (handle)	20
			21
<code>int MPI_Ineighbor_allgatherv(const void* sendbuf, int sendcount,</code>			21 ticket140.
<code> MPI_Datatype sendtype, void* recvbuf, const int recvcunts[],</code>			22 ticket140.
<code> const int displs[], MPI_Datatype recvtype, MPI_Comm comm,</code>			23 ticket140.
<code> MPI_Request *request)</code>			24
			25 ticket-248T.
<code>MPI_Ineighbor_allgatherv(sendbuf, sendcount, sendtype, recvbuf, recvcunts,</code>			26
<code> displs, recvtype, comm, request, ierror) BIND(C)</code>			27
<code> TYPE(*), DIMENSION(..), INTENT(IN), ASYNCHRONOUS :: sendbuf</code>			28
<code> TYPE(*), DIMENSION(..), ASYNCHRONOUS :: recvbuf</code>			29
<code> INTEGER, INTENT(IN) :: sendcount</code>			30
<code> INTEGER, INTENT(IN), ASYNCHRONOUS :: recvcunts(*), displs(*)</code>			31
<code> TYPE(MPI_Datatype), INTENT(IN) :: sendtype, recvtype</code>			32
<code> TYPE(MPI_Comm), INTENT(IN) :: comm</code>			33
<code> TYPE(MPI_Request), INTENT(OUT) :: request</code>			34
<code> INTEGER, OPTIONAL, INTENT(OUT) :: ierror</code>			35
			36
<code>MPI_INEIGHBOR_ALLGATHERV(SENDBUF, SENDCOUNT, SENDTYPE, RECVBUF, RECVCOUNTS,</code>			37
<code> DISPLS, RECVTYPE, COMM, REQUEST, IERROR)</code>			38
<code><type> SENDBUF(*), RECVBUF(*)</code>			39
<code>INTEGER SENDCOUNT, SENDTYPE, RECVCOUNTS(*), DISPLS(*), RECVTYPE, COMM,</code>			40
<code>REQUEST, IERROR</code>			41
			42
This call starts a nonblocking variant of <code>MPI_NEIGHBOR_ALLGATHERV</code> .			43
			44
			45
			46
			47
			48

7.7.2 Nonblocking Neighborhood Alltoall

```

MPI_INEIGHBOR_ALLTOALL(sendbuf, sendcount, sendtype, recvbuf, recvcoun
t, recvtype, comm, request)

```

IN	sendbuf	starting address of send buffer (choice)
IN	sendcount	number of elements sent to each neighbor (non-negative integer)
IN	sendtype	data type of send buffer elements (handle)
OUT	recvbuf	starting address of receive buffer (choice)
IN	recvcoun t	number of elements received from each neighbor (non-negative integer)
IN	recvtype	data type of receive buffer elements (handle)
IN	comm	communicator with topology structure (handle)
OUT	request	communication request (handle)

```

int MPI_Ineighbor_alltoall(const void* sendbuf, int sendcount, MPI_Datatype
sendtype, void* recvbuf, int recvcoun
t, MPI_Datatype recvtype,
MPI_Comm comm, MPI_Request *request)

```

```

MPI_Ineighbor_alltoall(sendbuf, sendcount, sendtype, recvbuf, recvcoun
t, recvtype, comm, request, ierror) BIND(C)
TYPE(*), DIMENSION(..), INTENT(IN), ASYNCHRONOUS :: sendbuf
TYPE(*), DIMENSION(..), ASYNCHRONOUS :: recvbuf
INTEGER, INTENT(IN) :: sendcount, recvcoun
t
TYPE(MPI_Datatype), INTENT(IN) :: sendtype, recvtype
TYPE(MPI_Comm), INTENT(IN) :: comm
TYPE(MPI_Request), INTENT(OUT) :: request
INTEGER, OPTIONAL, INTENT(OUT) :: ierror

```

```

MPI_INEIGHBOR_ALLTOALL(SENDBUF, SENDCOUNT, SENDTYPE, RECVBUF, REVCOUN
T, RECVTYPE, COMM, REQUEST, IERROR)
<type> SENDBUF(*), RECVBUF(*)
INTEGER SENDCOUNT, SENDTYPE, REVCOUN
T, RECVTYPE, COMM, REQUEST, IERROR

```

This call starts a nonblocking variant of MPI_NEIGHBOR_ALLTOALL.

<code>MPI_INEIGHBOR_ALLTOALLV(sendbuf, sendcounts, sdispls, sendtype, recvbuf, recvcnts,</code>			1
<code>rdispls, recvtype, comm, request)</code>			2
IN	<code>sendbuf</code>	starting address of send buffer (choice)	3
IN	<code>sendcounts</code>	non-negative integer array (of length outdegree) specifying the number of elements to send to each neighbor	4
IN	<code>sdispls</code>	integer array (of length outdegree). Entry <code>j</code> specifies the displacement (relative to <code>sendbuf</code>) from which send the outgoing data to neighbor <code>j</code>	5
IN	<code>sendtype</code>	data type of send buffer elements (handle)	6
OUT	<code>recvbuf</code>	starting address of receive buffer (choice)	7
IN	<code>recvcnts</code>	non-negative integer array (of length indegree) specifying the number of elements that are received from each neighbor	8
IN	<code>rdispls</code>	integer array (of length indegree). Entry <code>i</code> specifies the displacement (relative to <code>recvbuf</code>) at which to place the incoming data from neighbor <code>i</code>	9
IN	<code>recvtype</code>	data type of receive buffer elements (handle)	10
IN	<code>comm</code>	communicator with topology structure (handle)	11
OUT	<code>request</code>	communication request (handle)	12
 			13
<code>int MPI_Inighbor_alltoallv(const void* sendbuf, const int sendcounts[],</code>			14
<code>const int sdispls[], MPI_Datatype sendtype, void* recvbuf,</code>			15
<code>const int recvcnts[], const int rdispls[], MPI_Datatype</code>			16
<code>recvtype, MPI_Comm comm, MPI_Request *request)</code>			17
<code>MPI_Inighbor_alltoallv(sendbuf, sendcounts, sdispls, sendtype, recvbuf,</code>			18
<code>recvcnts, rdispls, recvtype, comm, request, ierror) BIND(C)</code>			19
<code>TYPE(*), DIMENSION(..), INTENT(IN), ASYNCHRONOUS :: sendbuf</code>			20
<code>TYPE(*), DIMENSION(..), ASYNCHRONOUS :: recvbuf</code>			21
<code>INTEGER, INTENT(IN), ASYNCHRONOUS :: sendcounts(*), sdispls(*),</code>			22
<code>recvcnts(*), rdispls(*)</code>			23
<code>TYPE(MPI_Datatype), INTENT(IN) :: sendtype, recvtype</code>			24
<code>TYPE(MPI_Comm), INTENT(IN) :: comm</code>			25
<code>TYPE(MPI_Request), INTENT(OUT) :: request</code>			26
<code>INTEGER, OPTIONAL, INTENT(OUT) :: ierror</code>			27
 			28
<code>MPI_INEIGHBOR_ALLTOALLV(SENDBUF, SENDCOUNTS, SDISPLS, SENDTYPE, RECVBUF,</code>			29
<code>RECVCOUNTS, RDISPLS, RECVTYPE, COMM, REQUEST, IERROR)</code>			30
<code><type> SENDBUF(*), RECVBUF(*)</code>			31
<code>INTEGER SENDCOUNTS(*), SDISPLS(*), SENDTYPE, RECVCOUNTS(*), RDISPLS(*),</code>			32
<code>RECVTYPE, COMM, REQUEST, IERROR</code>			33
 			34
<code>This call starts a nonblocking variant of MPI_NEIGHBOR_ALLTOALLV.</code>			35

ticket140.
ticket140.
ticket140.
ticket140.
ticket140.
ticket-248T.

```

1 MPI_INEIGHBOR_ALLTOALLW(sendbuf, sendcounts, sdispls, sendtypes, recvbuf, recvcounts,
2     rdispls, recvtypes, comm, request)
3
4     IN     sendbuf     starting address of send buffer (choice)
5
6     IN     sendcounts  non-negative integer array (of length outdegree) speci-
7     fying the number of elements to send to each neighbor
8
9     IN     sdispls     integer array (of length outdegree). Entry j specifies
10    the displacement in bytes (relative to sendbuf) from
11    which to take the outgoing data destined for neighbor
12    j (array of integers)
13
14    IN     sendtypes    array of datatypes (of length outdegree). Entry j spec-
15    ifies the type of data to send to neighbor j (array of
16    handles)
17
18    OUT    recvbuf      starting address of receive buffer (choice)
19
20    IN     recvcounts   non-negative integer array (of length indegree) speci-
21    fying the number of elements that are received from
22    each neighbor
23
24    IN     rdispls      integer array (of length indegree). Entry i specifies
25    the displacement in bytes (relative to recvbuf) at which
26    to place the incoming data from neighbor i (array of
27    integers)
28
29    IN     recvtypes    array of datatypes (of length indegree). Entry i spec-
30    ifies the type of data received from neighbor i (array
31    of handles)
32
33    IN     comm         communicator with topology structure (handle)
34
35    OUT    request      communication request (handle)

```

```

ticket140. 31 int MPI_Ineighbor_alltoallw(const void* sendbuf, const int sendcounts[],
ticket140. 32     const [int]MPI_Aint sdispls[], const MPI_Datatype sendtypes[],
ticket140. 33     void* recvbuf, const int recvcounts[], const [int]MPI_Aint
ticket299. 34     rdispls[], const MPI_Datatype recvtypes[], MPI_Comm comm,
ticket140. 35     MPI_Request *request)
ticket140. 36 MPI_Ineighbor_alltoallw(sendbuf, sendcounts, sdispls, sendtypes, recvbuf,
ticket140. 37     recvcounts, rdispls, recvtypes, comm, request, ierror) BIND(C)
ticket140. 38     TYPE(*), DIMENSION(..), INTENT(IN), ASYNCHRONOUS :: sendbuf
ticket-248T. 39     TYPE(*), DIMENSION(..), ASYNCHRONOUS :: recvbuf
40     INTEGER, INTENT(IN), ASYNCHRONOUS :: sendcounts(*), recvcounts(*)
41     INTEGER(KIND=MPI_ADDRESS_KIND), INTENT(IN), ASYNCHRONOUS ::
42     sdispls(*), rdispls(*)
43     TYPE(MPI_Datatype), INTENT(IN), ASYNCHRONOUS :: sendtypes(*),
44     recvtypes(*)
45     TYPE(MPI_Comm), INTENT(IN) :: comm
46     TYPE(MPI_Request), INTENT(OUT) :: request
47     INTEGER, OPTIONAL, INTENT(OUT) :: ierror
48

```



```

MPI_INEIGHBOR_ALLTOALLW(SENDBUF, SENDCOUNTS, SDISPLS, SENDTYPES, RECVBUFF,
    RECVCOUNTS, RDISPLS, RECVTYPES, COMM, REQUEST, IERROR)
    <type> SENDBUF(*), RECVBUFF(*)
    INTEGER(KIND=MPI_ADDRESS_KIND) SDISPLS(*), RDISPLS(*)
    INTEGER SENDCOUNTS(*), SENDTYPES(*), RECVCOUNTS(*), RECVTYPES(*), COMM,
    REQUEST, IERROR

```

This call starts a nonblocking variant of MPI_NEIGHBOR_ALLTOALLW.

7.8 An Application Example

Example 7.9 [] The example in [Figure 7.1]Figures 7.2-7.4 shows how the grid definition and inquiry functions can be used in an application program. A partial differential equation, for instance the Poisson equation, is to be solved on a rectangular domain. First, the processes organize themselves in a two-dimensional structure. Each process then inquires about the ranks of its neighbors in the four directions (up, down, right, left). The numerical problem is solved by an iterative method, the details of which are hidden in the subroutine `relax`.

In each relaxation step each process computes new values for the solution grid function at [all]the points `u(1:100,1:100)` owned by the process. Then the values at inter-process boundaries have to be exchanged with neighboring processes. For example, the [exchange subroutine might contain a call like `MPI_SEND(...,neigh_rank(1),...)` to send updated values to the left-hand neighbor `(i-1,j)`.]newly calculated values in `u(1,1:100)` must be sent into the halo cells `u(101,1:100)` of the left-hand neighbor with coordinates `(own_coord(1)-1,own_coord(2))`

[]

1
2
3
4
5
6
7
8
9
10
11
12
13 ticket258.
14 ticket258.
15 ticket258.
16 ticket258.
17
18
19
20
21 ticket258.
22 ticket258.
23 ticket258.
24
25
26 ticket258.
27 ticket258.
28 ticket258.
29 ticket258.
30
31
32
33
34
35
36
37
38
39
40
41
42
43
44
45
46
47
48

```

1
2
3   integer ndims, num_neigh
4   logical reorder
5   parameter (ndims=2, num_neigh=4, reorder=.true.)
6   integer comm, comm_cart, dims(ndims), neigh_def(ndims), ierr
7   integer neigh_rank(num_neigh), own_position(ndims), i, j
8   logical periods(ndims)
9   real*8 u(0:101,0:101), f(0:101,0:101)
10  data dims / ndims * 0 /
11  comm = MPI_COMM_WORLD
12  C   Set process grid size and periodicity
13  call MPI_DIMS_CREATE(comm, ndims, dims,ierr)
14  periods(1) = .TRUE.
15  periods(2) = .TRUE.
16  C   Create a grid structure in WORLD group and inquire about own position
17  call MPI_CART_CREATE (comm, ndims, dims, periods, reorder, comm_cart,ierr)
18  call MPI_CART_GET (comm_cart, ndims, dims, periods, own_position,ierr)
19  C   Look up the ranks for the neighbors. Own process coordinates are (i,j).
20  C   Neighbors are (i-1,j), (i+1,j), (i,j-1), (i,j+1)
21  i = own_position(1)
22  j = own_position(2)
23  neigh_def(1) = i-1
24  neigh_def(2) = j
25  call MPI_CART_RANK (comm_cart, neigh_def, neigh_rank(1),ierr)
26  neigh_def(1) = i+1
27  neigh_def(2) = j
28  call MPI_CART_RANK (comm_cart, neigh_def, neigh_rank(2),ierr)
29  neigh_def(1) = i
30  neigh_def(2) = j-1
31  call MPI_CART_RANK (comm_cart, neigh_def, neigh_rank(3),ierr)
32  neigh_def(1) = i
33  neigh_def(2) = j+1
34  call MPI_CART_RANK (comm_cart, neigh_def, neigh_rank(4),ierr)
35  C   Initialize the grid functions and start the iteration
36  call init (u, f)
37  do 10 it=1,100
38    call relax (u, f)
39  C   Exchange data with neighbor processes
40    call exchange (u, comm_cart, neigh_rank, num_neigh)
41 10  continue
42  call output (u)
43  end
44
45
46
47
48

```

Figure 7.1: Set-up of process structure for two-dimensional parallel Poisson solver.

```

1
2
3
4
5
6
7
8 INTEGER ndims, num_neigh
9 LOGICAL reorder
10 PARAMETER (ndims=2, num_neigh=4, reorder=.true.)
11 INTEGER comm, comm_cart, dims(ndims), ierr
12 INTEGER neigh_rank(num_neigh), own_coords(ndims), i, j, it
13 LOGICAL periods(ndims)
14 REAL u(0:101,0:101), f(0:101,0:101)
15 DATA dims / ndims * 0 /
16 comm = MPI_COMM_WORLD
17 ! Set process grid size and periodicity
18 CALL MPI_DIMS_CREATE(comm, ndims, dims,ierr)
19 periods(1) = .TRUE.
20 periods(2) = .TRUE.
21 ! Create a grid structure in WORLD group and inquire about own position
22 CALL MPI_CART_CREATE (comm, ndims, dims, periods, reorder, &
23                      comm_cart,ierr)
24 CALL MPI_CART_GET (comm_cart, ndims, dims, periods, own_coords,ierr)
25 i = own_coords(1)
26 j = own_coords(2)
27 ! Look up the ranks for the neighbors. Own process coordinates are (i,j).
28 ! Neighbors are (i-1,j), (i+1,j), (i,j-1), (i,j+1) modulo (dims(1),dims(2))
29 CALL MPI_CART_SHIFT (comm_cart, 0,1, neigh_rank(1),neigh_rank(2), ierr)
30 CALL MPI_CART_SHIFT (comm_cart, 1,1, neigh_rank(3),neigh_rank(4), ierr)
31 ! Initialize the grid functions and start the iteration
32 CALL init (u, f)
33 DO it=1,100
34     CALL relax (u, f)
35     ! Exchange data with neighbor processes
36     CALL exchange (u, comm_cart, neigh_rank, num_neigh)
37 END DO
38 CALL output (u)
39
40
41
42
43
44
45
46
47
48

```

Figure 7.2: Set-up of process structure for two-dimensional parallel Poisson solver.

```

1
2
3
4
5
6
7
8
9
10
11
12 SUBROUTINE exchange (u, comm_cart, neigh_rank, num_neigh)
13 REAL u(0:101,0:101)
14 INTEGER comm_cart, num_neigh, neigh_rank(num_neigh)
15 REAL sndbuf(100,num_neigh), rcvbuf(100,num_neigh)
16 INTEGER ierr
17 sndbuf(1:100,1) = u( 1,1:100)
18 sndbuf(1:100,2) = u(100,1:100)
19 sndbuf(1:100,3) = u(1:100, 1)
20 sndbuf(1:100,4) = u(1:100,100)
21 CALL MPI_NEIGHBOR_ALLTOALL (sndbuf, 100, MPI_REAL, rcvbuf, 100, MPI_REAL, &
22                             comm_cart, ierr)
23 ! instead of
24 ! DO i=1,num_neigh
25 !   CALL MPI_Irecv(rcvbuf(1,i),100,MPI_REAL,neigh_rank(i),...,rq(2*i-1),ierr)
26 !   CALL MPI_Isend(sndbuf(1,i),100,MPI_REAL,neigh_rank(i),...,rq(2*i  ),ierr)
27 ! END DO
28 ! CALL MPI_WAITALL (2*num_neigh, rq, statuses, ierr)
29
30 u( 0,1:100) = rcvbuf(1:100,1)
31 u(101,1:100) = rcvbuf(1:100,2)
32 u(1:100, 0) = rcvbuf(1:100,3)
33 u(1:100,101) = rcvbuf(1:100,4)
34 END
35
36
37
38
39
40
41
42
43
44
45
46
47
48

```

Figure 7.3: Communication routine with local data copying and sparse neighborhood all-to-all.

```

1
2
3 SUBROUTINE exchange (u, comm_cart, neigh_rank, num_neigh)
4 USE MPI
5 REAL u(0:101,0:101)
6 INTEGER comm_cart, num_neigh, neigh_rank(num_neigh)
7 INTEGER sndcounts(num_neigh), sndtypes(num_neigh)
8 INTEGER rcvcounts(num_neigh), rcvtypes(num_neigh)
9 INTEGER (KIND=MPI_ADDRESS_KIND) lb, sizeofreal, sdispls(num_neigh), &
10         rdispls(num_neigh)
11
12 INTEGER type_vec, i, ierr
13 ! The following initialization need to be done only once
14 ! before the first call of exchange.
15 CALL MPI_TYPE_GET_EXTENT(MPI_REAL, lb, sizeofreal, ierr)
16 CALL MPI_TYPE_VECTOR (100, 1, 102, MPI_REAL, type_vec, ierr)
17 CALL MPI_TYPE_COMMIT (type_vec, ierr)
18 sndtypes(1) = type_vec
19 sndtypes(2) = type_vec
20 sndtypes(3) = MPI_REAL
21 sndtypes(4) = MPI_REAL
22 DO i=1,num_neigh
23     sndcounts(i) = 100
24     rcvcounts(i) = 100
25     rcvtypes(i) = sndtypes(i)
26 END DO
27 sdispls(1) = ( 1 + 1*102) * sizeofreal ! first element of u( 1,1:100)
28 sdispls(2) = (100 + 1*102) * sizeofreal ! first element of u(100,1:100)
29 sdispls(3) = ( 1 + 1*102) * sizeofreal ! first element of u(1:100, 1)
30 sdispls(4) = ( 1 + 100*102) * sizeofreal ! first element of u(1:100,100)
31 rdispls(1) = ( 0 + 1*102) * sizeofreal ! first element of u( 0,1:100)
32 rdispls(2) = (101 + 1*102) * sizeofreal ! first element of u(101,1:100)
33 rdispls(3) = ( 1 + 0*102) * sizeofreal ! first element of u(1:100, 0)
34 rdispls(4) = ( 1 + 101*102) * sizeofreal ! first element of u(1:100,101)
35
36 ! the following communication has to be done in each call of exchange
37 CALL MPI_NEIGHBOR_ALLTOALLW (u, sndcounts, sdispls, sndtypes, &
38         u, rcvcounts, rdispls, rcvtypes, comm_cart, ierr)
39
40 ! The following finalizing need to be done only once
41 ! after the last call of exchange.
42 CALL MPI_TYPE_FREE (type_vec, ierr)
43
44 END

```

Figure 7.4: Communication routine with sparse neighborhood all-to-all-w and without local data copying.

1
2
3
4
5
6
7
8
9
10
11
12
13
14
15
16
17
18
19
20
21
22
23
24
25
26
27
28
29
30
31
32
33
34
35
36
37
38
39
40
41
42
43
44
45
46
47
48

Chapter 8

MPI Environmental Management

This chapter discusses routines for getting and, where appropriate, setting various parameters that relate to the MPI implementation and the execution environment (such as error handling). The procedures for entering and leaving the MPI execution environment are also described here.

8.1 Implementation Information

8.1.1 Version Inquiries

In order to cope with changes to the MPI Standard, there are both compile-time and run-time ways to determine which version of the standard is in use in the environment one is using.

The “version” will be represented by two separate integers, for the version and subversion: In C and C++, [

```
#define MPI_VERSION    2
#define MPI_SUBVERSION 2
```

in Fortran, HEADER SKIP ENDHEADER

```
INTEGER [ticket240-L.]:: MPI_VERSION, MPI_SUBVERSION
PARAMETER (MPI_VERSION    = 2)
PARAMETER (MPI_SUBVERSION = 2)
```

```
]
```

```
#define MPI_VERSION    3
#define MPI_SUBVERSION 0
```

in Fortran,

```
INTEGER MPI_VERSION, MPI_SUBVERSION
PARAMETER (MPI_VERSION    = 3)
PARAMETER (MPI_SUBVERSION = 0)
```

For runtime determination,

1 MPI_GET_VERSION(version, subversion)

2 OUT version version number (integer)

3 OUT subversion subversion number (integer)

4
5
6 int MPI_Get_version(int *version, int *subversion)

7 MPI_Get_version(version, subversion, ierror) BIND(C)

8 INTEGER, INTENT(OUT) :: version, subversion

9 INTEGER, OPTIONAL, INTENT(OUT) :: ierror

10
11 MPI_GET_VERSION(VERSION, SUBVERSION, IERROR)

12 INTEGER VERSION, SUBVERSION, IERROR

13
14 {void MPI::Get_version(int& version, int& subversion) (*binding deprecated, see*
15 *Section 15.2*) }

16 [
17 MPI_GET_VERSION is one of the few functions that can be called]

18 before MPI_INIT and after MPI_FINALIZE. Valid (MPI_VERSION, MPI_SUBVERSION)
19 pairs in this and previous versions of the MPI standard are [(3,0), (2,2), (2,1), (2,0), and
20 (1,2)].

21
22
23 MPI_GET_LIBRARY_VERSION(version, resultlen)

24 OUT version version string (string)

25 OUT resultlen Length (in printable characters) of the result returned
26 in version (integer)

27
28
29 int MPI_Get_library_version(char *version, int *resultlen)

30 MPI_GET_LIBRARY_VERSION(VERSION, RESULTEN, IERROR)

31 CHARACTER*(*) VERSION

32 INTEGER RESULTLEN, IERROR

33
34 This routine returns a string representing the version of the MPI library. The version
35 argument is a character string for maximum flexibility.

36
37 *Advice to implementors.* An implementation of MPI should return a different string
38 for every change to its source code or build that could be visible to the user. (*End of*
39 *advice to implementors.*)

40
41 The argument version must represent storage that is MPI_MAX_LIBRARY_VERSION_STRING
42 characters long. MPI_GET_LIBRARY_VERSION may write up to this many characters into
43 version.

44 The number of characters actually written is returned in the output argument, resultlen.
45 In C, a null character is additionally stored at version[resultlen]. The value of resultlen cannot
46 be larger than MPI_MAX_LIBRARY_VERSION_STRING - 1. In Fortran, version is padded on
47 the right with blank characters. The value of resultlen cannot be larger than

MPI_MAX_LIBRARY_VERSION_STRING.

MPI_GET_VERSION and **MPI_GET_LIBRARY_VERSION** are two of the few functions that can be called before **MPI_INIT** and after **MPI_FINALIZE**.

8.1.2 Environmental Inquiries

A set of attributes that describe the execution environment are attached to the communicator **MPI_COMM_WORLD** when MPI is initialized. The value of these attributes can be inquired by using the function **MPI_COMM_GET_ATTR** described in Chapter 6. It is erroneous to delete these attributes, free their keys, or change their values.

The list of predefined attribute keys include

MPI_TAG_UB Upper bound for tag value.

MPI_HOST Host process rank, if such exists, **MPI_PROC_NULL**, otherwise.

MPI_IO rank of a node that has regular I/O facilities (possibly myrank). Nodes in the same communicator may return different values for this parameter.

MPI_WTIME_IS_GLOBAL Boolean variable that indicates whether clocks are synchronized.

Vendors may add implementation specific parameters (such as node number, real memory size, virtual memory size, etc.)

These predefined attributes do not change value between MPI initialization (**MPI_INIT**) and MPI completion (**MPI_FINALIZE**), and cannot be updated or deleted by users.

Advice to users. Note that in the C binding, the value returned by these attributes is a *pointer* to an `int` containing the requested value. (*End of advice to users.*)

The required parameter values are discussed in more detail below:

Tag Values

Tag values range from 0 to the value returned for **MPI_TAG_UB** inclusive. These values are guaranteed to be unchanging during the execution of an MPI program. In addition, the tag upper bound value must be *at least* 32767. An MPI implementation is free to make the value of **MPI_TAG_UB** larger than this; for example, the value $2^{30} - 1$ is also a **[legal]valid** value for **MPI_TAG_UB**.

The attribute **MPI_TAG_UB** has the same value on all processes of **MPI_COMM_WORLD**.

Host Rank

The value returned for **MPI_HOST** gets the rank of the **HOST** process in the group associated with communicator **MPI_COMM_WORLD**, if there is such. **MPI_PROC_NULL** is returned if there is no host. MPI does not specify what it means for a process to be a **HOST**, nor does it require that a **HOST** exists.

The attribute **MPI_HOST** has the same value on all processes of **MPI_COMM_WORLD**.

IO Rank

The value returned for `MPI_IO` is the rank of a processor that can provide language-standard I/O facilities. For Fortran, this means that all of the Fortran I/O operations are supported (e.g., `OPEN`, `REWIND`, `WRITE`). For C and C++, this means that all of the ISO C and C++, I/O operations are supported (e.g., `fopen`, `fprintf`, `lseek`).

If every process can provide language-standard I/O, then the value `MPI_ANY_SOURCE` will be returned. Otherwise, if the calling process can provide language-standard I/O, then its rank will be returned. Otherwise, if some process can provide language-standard I/O then the rank of one such process will be returned. The same value need not be returned by all processes. If no process can provide language-standard I/O, then the value `MPI_PROC_NULL` will be returned.

Advice to users. Note that input is not collective, and this attribute does *not* indicate which process can or does provide input. (*End of advice to users.*)

Clock Synchronization

The value returned for `MPI_WTIME_IS_GLOBAL` is 1 if clocks at all processes in `MPI_COMM_WORLD` are synchronized, 0 otherwise. A collection of clocks is considered synchronized if explicit effort has been taken to synchronize them. The expectation is that the variation in time, as measured by calls to `MPI_WTIME`, will be less than one half the round-trip time for an MPI message of length zero. If time is measured at a process just before a send and at another process just after a matching receive, the second time should be always higher than the first one.

The attribute `MPI_WTIME_IS_GLOBAL` need not be present when the clocks are not synchronized (however, the attribute key `MPI_WTIME_IS_GLOBAL` is always valid). This attribute may be associated with communicators other than `MPI_COMM_WORLD`.

The attribute `MPI_WTIME_IS_GLOBAL` has the same value on all processes of `MPI_COMM_WORLD`.

Inquire Processor Name

`MPI_GET_PROCESSOR_NAME(name, resultlen)`

OUT	name	A unique specifier for the actual (as opposed to virtual) node.
OUT	resultlen	Length (in printable characters) of the result returned in name

`int MPI_Get_processor_name(char *name, int *resultlen)`

```
MPI_Get_processor_name(name, resultlen, ierror) BIND(C)
    CHARACTER(LEN=MPI_MAX_PROCESSOR_NAME), INTENT(OUT) :: name
    INTEGER, INTENT(OUT) :: resultlen
    INTEGER, OPTIONAL, INTENT(OUT) :: ierror
```

`MPI_GET_PROCESSOR_NAME(NAME, RESULTLEN, IERROR)`

```

CHARACTER*(*) NAME
INTEGER RESULTLEN, IERROR
{void MPI::Get_processor_name(char* name, int& resultlen) (binding deprecated,
    see Section 15.2) }
```

This routine returns the name of the processor on which it was called at the moment of the call. The name is a character string for maximum flexibility. From this value it must be possible to identify a specific piece of hardware; possible values include “processor 9 in rack 4 of mpp.cs.org” and “231” (where 231 is the actual processor number in the running homogeneous system). The argument `name` must represent storage that is at least `MPI_MAX_PROCESSOR_NAME` characters long. `MPI_GET_PROCESSOR_NAME` may write up to this many characters into `name`.

The number of characters actually written is returned in the output argument, `resultlen`. In C, a null character is additionally stored at `name[resultlen]`. The **value of** `resultlen` cannot be larger **[then]than** `MPI_MAX_PROCESSOR_NAME-1`. In Fortran, `name` is padded on the right with blank characters. The **value of** `resultlen` cannot be larger **[then]than** `MPI_MAX_PROCESSOR_NAME`.

Rationale. This function allows MPI implementations that do process migration to return the current processor. Note that nothing in MPI *requires* or defines process migration; this definition of `MPI_GET_PROCESSOR_NAME` simply allows such an implementation. (*End of rationale.*)

Advice to users. The user must provide at least `MPI_MAX_PROCESSOR_NAME` space to write the processor name — processor names can be this long. The user should examine the output argument, `resultlen`, to determine the actual length of the name. (*End of advice to users.*)

□ The constant `MPI_BSEND_OVERHEAD` provides an upper bound on the fixed overhead per message buffered by a call to `MPI_BSEND` (see Section 3.6.1).

8.2 Memory Allocation

In some systems, message-passing and remote-memory-access (RMA) operations run faster when accessing specially allocated memory (e.g., memory that is shared by the other processes in the communicating group on an SMP). MPI provides a mechanism for allocating and freeing such special memory. The use of such memory for message-passing or RMA is not mandatory, and this memory can be used without restrictions as any other dynamically allocated memory. However, implementations may restrict the use of the `MPI_WIN_LOCK` and `MPI_WIN_UNLOCK` functions to windows allocated in such memory (see Section 11.5.3.)

```
MPI_ALLOC_MEM(size, info, baseptr)
```

IN	size	size of memory segment in bytes (non-negative integer)
IN	info	info argument (handle)
OUT	baseptr	pointer to beginning of memory segment allocated

```

1 int MPI_Alloc_mem(MPI_Aint size, MPI_Info info, void *baseptr)
ticket-248T. 2
3 MPI_Alloc_mem(size, info, baseptr, ierror) BIND(C)
4     USE, INTRINSIC :: ISO_C_BINDING, ONLY : C_PTR
5     INTEGER(KIND=MPI_ADDRESS_KIND), INTENT(IN) :: size
6     TYPE(MPI_Info), INTENT(IN) :: info
7     TYPE(C_PTR), INTENT(OUT) :: baseptr
8     INTEGER, OPTIONAL, INTENT(OUT) :: ierror
9
10 MPI_ALLOC_MEM(SIZE, INFO, BASEPTR, IERROR)
11     INTEGER INFO, IERROR
12     INTEGER(KIND=MPI_ADDRESS_KIND) SIZE, BASEPTR
ticket229.1. 13
14 {void* MPI::Alloc_mem(MPI::Aint size, const MPI::Info& info) (binding
15     deprecated, see Section 15.2) }
ticket229.1. 16
17     ¶If the Fortran compiler provides TYPE(C_PTR), then the following interface must be
18     provided in the mpi module and should be provided in mpif.h through overloading, i.e., with
19     the same routine name as the routine with INTEGER(KIND=MPI_ADDRESS_KIND) BASEPTR,
20     but with a different linker name:
21
22     INTERFACE MPI_ALLOC_MEM
23         SUBROUTINE MPI_ALLOC_MEM_CPTR(SIZE, INFO, BASEPTR, IERROR)
24             USE, INTRINSIC :: ISO_C_BINDING, ONLY : C_PTR
25             INTEGER :: INFO, IERROR
26             INTEGER(KIND=MPI_ADDRESS_KIND) :: SIZE
27             TYPE(C_PTR) :: BASEPTR
28         END SUBROUTINE
29     END INTERFACE
30
31     The linker name base of this overloaded function is MPI_ALLOC_MEM_CPTR. The
32     implied linker names are described in Section 16.2.5 on page 653.
33
34     The info argument can be used to provide directives that control the desired location
35     of the allocated memory. Such a directive does not affect the semantics of the call. Valid
36     info values are implementation-dependent; a null directive value of info = MPI_INFO_NULL
37     is always valid.
38
39     The function MPI_ALLOC_MEM may return an error code of class MPI_ERR_NO_MEM
40     to indicate it failed because memory is exhausted.
41
42
43 MPI_FREE_MEM(base)
44     IN          base          initial address of memory segment allocated by
45                                MPI_ALLOC_MEM (choice)
46
47
48 int MPI_Free_mem(void *base)
ticket229.2. 49
50 MPI_Free_mem(base, ierror) BIND(C)
ticket-248T. 51     TYPE(*), DIMENSION(..), INTENT(IN), ASYNCHRONOUS :: base
52     INTEGER, OPTIONAL, INTENT(OUT) :: ierror
53
54 MPI_FREE_MEM(BASE, IERROR)

```

```

<type> BASE(*)
INTEGER IERROR
{void MPI::Free_mem(void *base) (binding deprecated, see Section 15.2) }

```

The function `MPI_FREE_MEM` may return an error code of class `MPI_ERR_BASE` to indicate an invalid base argument.

Rationale. The C and C++ bindings of `MPI_ALLOC_MEM` and `MPI_FREE_MEM` are similar to the bindings for the `malloc` and `free` C library calls: a call to `MPI_Alloc_mem(..., &base)` should be paired with a call to `MPI_Free_mem(base)` (one less level of indirection). Both arguments are declared to be of same type `void*` so as to facilitate type casting. The Fortran binding is consistent with the C and C++ bindings: the Fortran `MPI_ALLOC_MEM` call returns in `baseptr` the `TYPE(C_PTR)` pointer or the (integer valued) address of the allocated memory. The `base` argument of `MPI_FREE_MEM` is a choice argument, which passes (a reference to) the variable stored at that location. (*End of rationale.*)

Advice to implementors. If `MPI_ALLOC_MEM` allocates special memory, then a design similar to the design of C `malloc` and `free` functions has to be used, in order to find out the size of a memory segment, when the segment is freed. If no special memory is used, `MPI_ALLOC_MEM` simply invokes `malloc`, and `MPI_FREE_MEM` invokes `free`.

A call to `MPI_ALLOC_MEM` can be used in shared memory systems to allocate memory in a shared memory segment. (*End of advice to implementors.*)

Example 8.1 Example of use of `MPI_ALLOC_MEM`, in Fortran with `TYPE(C_PTR)` pointers. We assume 4-byte REALs.

```

USE mpi_f08 ! or USE mpi (not guaranteed with INCLUDE 'mpif.h')
USE, INTRINSIC :: ISO_C_BINDING
TYPE(C_PTR) :: p
REAL, DIMENSION(:, :), POINTER :: a ! no memory is allocated
INTEGER, DIMENSION(2) :: shape
INTEGER(KIND=MPI_ADDRESS_KIND) :: size
shape = (/100,100/)
size = 4 * shape(1) * shape(2) ! assuming 4 bytes per REAL
CALL MPI_Alloc_mem(size, MPI_INFO_NULL, p, ierr) ! memory is allocated and
CALL C_F_POINTER(p, a, shape) ! intrinsic ! now accessible via a(i,j)
... ! in ISO_C_BINDING
a(3,5) = 2.71;
...
CALL MPI_Free_mem(a, ierr) ! memory is freed

```

Example 8.2 [] Example of use of `MPI_ALLOC_MEM`, in Fortran with [pointer support]non-standard *Cray-pointer*. We assume 4-byte REALs, and assume that these pointers are address-sized.

```

1   REAL A
2   POINTER (P, A(100,100)) ! no memory is allocated
3   [ticket245-Q.]INTEGER(KIND=MPI_ADDRESS_KIND) SIZE
4   [ticket245-Q.]SIZE = 4*100*100
5   CALL MPI_ALLOC_MEM([ticket245-Q.][4*100*100]SIZE, MPI_INFO_NULL, P, IERR)
6   ! memory is allocated
7   ...
8   A(3,5) = 2.71;
9   ...
10  CALL MPI_FREE_MEM(A, IERR) ! memory is freed

```

ticket245-Q. [Since standard Fortran does not support (C-like) pointers, this] This code is not Fortran
ticket245-Q. 77 or Fortran 90 code. Some compilers [(in particular, at the time of writing, g77 and Fortran
ticket245-Q. compilers for Intel) do] may not support this code or need a special option, e.g., the GNU
ticket245-Q. gFortran compiler needs `-fcray-pointer`.

ticket229.2. *Advice to implementors.* Some compilers map Cray-pointers to address-sized integers,
17 some to `TYPE(C_PTR)` pointers (e.g., Cray Fortran, version 7.3.3). From the user's
18 viewpoint, this mapping is irrelevant because Examples 8.2 should work correctly
19 with an MPI-3.0 (or later) library if Cray-pointers are available. (*End of advice to*
20 *implementors.*)

23 **Example 8.3** Same example, in C

```

24  float (*f)[100][100];
25  /* no memory is allocated */
26  MPI_Alloc_mem(sizeof(float)*100*100, MPI_INFO_NULL, &f);
27  /* memory allocated */
28  ...
29  (*f)[5][3] = 2.71;
30  ...
31  MPI_Free_mem(f);

```

34 8.3 Error Handling

36 An MPI implementation cannot or may choose not to handle some errors that occur during
37 MPI calls. These can include errors that generate exceptions or traps, such as floating point
38 errors or access violations. The set of errors that are handled by MPI is implementation-
39 dependent. Each such error generates an **MPI exception**.

40 The above text takes precedence over any text on error handling within this document.
41 Specifically, text that states that errors *will* be handled should be read as *may* be handled.

42 A user can associate error handlers to three types of objects: communicators, windows,
43 and files. The specified error handling routine will be used for any MPI exception that occurs
44 during a call to MPI for the respective object. MPI calls that are not related to any objects
45 are considered to be attached to the communicator `MPI_COMM_WORLD`. The attachment
46 of error handlers to objects is purely local: different processes may attach different error
47 handlers to corresponding objects.

48 Several predefined error handlers are available in MPI:

MPI_ERRORS_ARE_FATAL The handler, when called, causes the program to abort on all executing processes. This has the same effect as if `MPI_ABORT` was called by the process that invoked the handler.

MPI_ERRORS_RETURN The handler has no effect other than returning the error code to the user.

Implementations may provide additional predefined error handlers and programmers can code their own error handlers.

The error handler `MPI_ERRORS_ARE_FATAL` is associated by default with `MPI_COMM_WORLD` after initialization. Thus, if the user chooses not to control error handling, every error that MPI handles is treated as fatal. Since (almost) all MPI calls return an error code, a user may choose to handle errors in its main code, by testing the return code of MPI calls and executing a suitable recovery code when the call was not successful. In this case, the error handler `MPI_ERRORS_RETURN` will be used. Usually it is more convenient and more efficient not to test for errors after each MPI call, and have such error handled by a non trivial MPI error handler.

After an error is detected, the state of MPI is undefined. That is, using a user-defined error handler, or `MPI_ERRORS_RETURN`, does *not* necessarily allow the user to continue to use MPI after an error is detected. The purpose of these error handlers is to allow a user to issue user-defined error messages and to take actions unrelated to MPI (such as flushing I/O buffers) before a program exits. An MPI implementation is free to allow MPI to continue after an error but is not required to do so.

Advice to implementors. A good quality implementation will, to the greatest possible extent, circumscribe the impact of an error, so that normal processing can continue after an error handler was invoked. The implementation documentation will provide information on the possible effect of each class of errors. (*End of advice to implementors.*)

An MPI error handler is an opaque object, which is accessed by a handle. MPI calls are provided to create new error handlers, to associate error handlers with objects, and to test which error handler is associated with an object. C and C++ have distinct typedefs for user defined error handling callback functions that accept communicator, file, and window arguments. In Fortran there are three user routines.

An error handler object is created by a call to `MPI_XXX_CREATE_ERRHANDLER(function, errhandler)`, where XXX is, respectively, `COMM`, `WIN`, or `FILE`.

An error handler is attached to a communicator, window, or file by a call to `MPI_XXX_SET_ERRHANDLER`. The error handler must be either a predefined error handler, or an error handler that was created by a call to `MPI_XXX_CREATE_ERRHANDLER`, with matching XXX. The predefined error handlers `MPI_ERRORS_RETURN` and `MPI_ERRORS_ARE_FATAL` can be attached to communicators, windows, and files. In C++, the predefined error handler `MPI::ERRORS_THROW_EXCEPTIONS` can also be attached to communicators, windows, and files.

The error handler currently associated with a communicator, window, or file can be retrieved by a call to `MPI_XXX_GET_ERRHANDLER`.

The MPI function `MPI_ERRHANDLER_FREE` can be used to free an error handler that was created by a call to `MPI_XXX_CREATE_ERRHANDLER`.

`MPI_{COMM,WIN,FILE}_GET_ERRHANDLER` behave as if a new error handler object is created. That is, once the error handler is no longer needed, `MPI_ERRHANDLER_FREE`

should be called with the error handler returned from `MPI_ERRHANDLER_GET` or `MPI_{COMM,WIN,FILE}_GET_ERRHANDLER` to mark the error handler for deallocation. This provides behavior similar to that of `MPI_COMM_GROUP` and `MPI_GROUP_FREE`.

Advice to implementors. High-quality implementation should raise an error when an error handler that was created by a call to `MPI_XXX_CREATE_ERRHANDLER` is attached to an object of the wrong type with a call to `MPI_YYY_SET_ERRHANDLER`. To do so, it is necessary to maintain, with each error handler, information on the typedef of the associated user function. (*End of advice to implementors.*)

The syntax for these calls is given below.

8.3.1 Error Handlers for Communicators

ticket252-W.	<code>MPI_COMM_CREATE_ERRHANDLER</code>	(<code>[function]</code> <code>comm_errhandler_fn</code> , <code>errhandler</code>)
	IN	<code>[ticket252-W.]</code> <code>[function]</code> <code>comm_errhandler_fn</code> user defined error handling procedure (function)
	OUT	<code>errhandler</code> MPI error handler (handle)

ticket252-W. ticket-248T.	<code>int MPI_Comm_create_errhandler</code>	(<code>MPI_Comm_errhandler_function</code> <code>*[function]</code> <code>comm_errhandler_fn</code> , <code>MPI_Errhandler *errhandler</code>)
	<code>MPI_Comm_create_errhandler</code>	(<code>comm_errhandler_fn</code> , <code>errhandler</code> , <code>ierror</code>) <code>BIND(C)</code> <code>PROCEDURE</code> (<code>MPI_Comm_errhandler_function</code>) <code>:: comm_errhandler_fn</code> <code>TYPE</code> (<code>MPI_Errhandler</code>), <code>INTENT</code> (<code>OUT</code>) <code>:: errhandler</code> <code>INTEGER</code> , <code>OPTIONAL</code> , <code>INTENT</code> (<code>OUT</code>) <code>:: ierror</code>
ticket252-W. ticket252-W.	<code>MPI_COMM_CREATE_ERRHANDLER</code>	(<code>[FUNCTION]</code> <code>COMM_ERRHANDLER_FN</code> , <code>ERRHANDLER</code> , <code>IERROR</code>) <code>EXTERNAL [FUNCTION]</code> <code>COMM_ERRHANDLER_FN</code> <code>INTEGER ERRHANDLER</code> , <code>IERROR</code>
ticket252-W.	{ <code>static MPI::Errhandler</code>	<code>MPI::Comm::Create_errhandler</code> (<code>MPI::Comm::Errhandler_function*</code> <code>[function]</code> <code>comm_errhandler_fn</code>) (<i>binding deprecated, see Section 15.2</i>) }

Creates an error handler that can be attached to communicators. This function is identical to `MPI_ERRHANDLER_CREATE`, whose use is deprecated.

The user routine should be, in C, a function of type `MPI_Comm_errhandler_function`, which is defined as

```
typedef void MPI_Comm_errhandler_function(MPI_Comm *, int *, ...);
```

The first argument is the communicator in use. The second is the error code to be returned by the MPI routine that raised the error. If the routine would have returned `MPI_ERR_IN_STATUS`, it is the error code returned in the status for the request that caused the error handler to be invoked. The remaining arguments are “`stdargs`” arguments whose number and meaning is implementation-dependent. An implementation should clearly document these arguments. Addresses are used so that the handler may be written in Fortran. This typedef replaces `MPI_Handler_function`, whose use is deprecated.

With the Fortran `mpi_f08` module, the user routine `comm_errhandler_fn` should be of the form:

ABSTRACT INTERFACE

```
SUBROUTINE MPI_Comm_errhandler_function(comm, error_code) BIND(C)
  TYPE(MPI_Comm) :: comm
  INTEGER :: error_code
```

[In Fortran] With the Fortran `mpi` module and `mpif.h`, the user routine `COMM_ERRHANDLER_FN` should be of the form:

```
SUBROUTINE COMM_ERRHANDLER_FUNCTION(COMM, ERROR_CODE)
  INTEGER COMM, ERROR_CODE
```

In C++, the user routine should be of the form:

```
{typedef void MPI::Comm::Errhandler_function(MPI::Comm &, int *, ...);
   (binding deprecated, see Section 15.2)}
```

Rationale. The variable argument list is provided because it provides an ISO-standard hook for providing additional information to the error handler; without this hook, ISO C prohibits additional arguments. (*End of rationale.*)

Advice to users. A newly created communicator inherits the error handler that is associated with the “parent” communicator. In particular, the user can specify a “global” error handler for all communicators by associating this handler with the communicator `MPI_COMM_WORLD` immediately after initialization. (*End of advice to users.*)

`MPI_COMM_SET_ERRHANDLER(comm, errhandler)`

INOUT	comm	communicator (handle)
IN	errhandler	new error handler for communicator (handle)

`int MPI_Comm_set_errhandler(MPI_Comm comm, MPI_Errhandler errhandler)`

```
MPI_Comm_set_errhandler(comm, errhandler, ierror) BIND(C)
  TYPE(MPI_Comm), INTENT(IN) :: comm
  TYPE(MPI_Errhandler), INTENT(IN) :: errhandler
  INTEGER, OPTIONAL, INTENT(OUT) :: ierror
```

```
MPI_COMM_SET_ERRHANDLER(COMM, ERRHANDLER, IERROR)
  INTEGER COMM, ERRHANDLER, IERROR
```

```
{void MPI::Comm::Set_errhandler(const MPI::Errhandler& errhandler) (binding
   deprecated, see Section 15.2) }
```

Attaches a new error handler to a communicator. The error handler must be either a predefined error handler, or an error handler created by a call to

1 ticket230-B.

2 ticket-248T.

3

4

5

6

7

8

9 ticket230-B.

10 ticket230-B.

11

12

13

14

15

16

17

18

19

20

21

22

23

24

25

26

27

28

29

30

31

32

33

34

35

36 ticket-248T.

37

38

39

40

41

42

43

44

45

46

47

48

1 MPI_COMM_CREATE_ERRHANDLER. This call is identical to MPI_ERRHANDLER_SET,
2 whose use is deprecated.

3
4
5 MPI_COMM_GET_ERRHANDLER(comm, errhandler)

6 IN comm communicator (handle)
7
8 OUT errhandler error handler currently associated with communicator
9 (handle)

10
11 int MPI_Comm_get_errhandler(MPI_Comm comm, MPI_Errhandler *errhandler)

12 MPI_Comm_get_errhandler(comm, errhandler, ierror) BIND(C)
13 TYPE(MPI_Comm), INTENT(IN) :: comm
14 TYPE(MPI_Errhandler), INTENT(OUT) :: errhandler
15 INTEGER, OPTIONAL, INTENT(OUT) :: ierror

16
17 MPI_COMM_GET_ERRHANDLER(COMM, ERRHANDLER, IERROR)
18 INTEGER COMM, ERRHANDLER, IERROR

19 {MPI::Errhandler MPI::Comm::Get_errhandler() const(*binding deprecated, see*
20 *Section 15.2*) }

21
22 Retrieves the error handler currently associated with a communicator. This call is
23 identical to MPI_ERRHANDLER_GET, whose use is deprecated.

24 Example: A library function may register at its entry point the current error handler
25 for a communicator, set its own private error handler for this communicator, and restore
26 before exiting the previous error handler.

27 28 8.3.2 Error Handlers for Windows

29
30
31 MPI_WIN_CREATE_ERRHANDLER(*[function]*win_errhandler_fn, errhandler)

32 IN *[ticket252-W.]**[function]*win_errhandler_fn user defined error handling procedure (func-
33 tion)
34
35 OUT errhandler MPI error handler (handle)

36
37 int MPI_Win_create_errhandler(MPI_Win_errhandler_function
38 **[function]*win_errhandler_fn, MPI_Errhandler *errhandler)

39 MPI_Win_create_errhandler(win_errhandler_fn, errhandler, ierror) BIND(C)
40 PROCEDURE(MPI_Win_errhandler_function) :: win_errhandler_fn
41 TYPE(MPI_Errhandler), INTENT(OUT) :: errhandler
42 INTEGER, OPTIONAL, INTENT(OUT) :: ierror

43
44 MPI_WIN_CREATE_ERRHANDLER(*[FUNCTION]*WIN_ERRHANDLER_FN, ERRHANDLER, IERROR)
45 EXTERNAL *[FUNCTION]*WIN_ERRHANDLER_FN
46 INTEGER ERRHANDLER, IERROR

```
{static MPI::Errhandler
    MPI::Win::Create_errhandler(MPI::Win::Errhandler_function*
        [function]win_errhandler_fn) (binding deprecated, see Section 15.2) }
```

Creates an error handler that can be attached to a window object. The user routine should be, in C, a function of type `MPI_Win_errhandler_function` which is defined as

```
typedef void MPI_Win_errhandler_function(MPI_Win *, int *, ...);
```

The first argument is the window in use, the second is the error code to be returned.

With the Fortran `mpi_f08` module, the user routine `win_errhandler_fn` should be of the form:

```
ABSTRACT INTERFACE
    SUBROUTINE MPI_Win_errhandler_function(win, error_code) BIND(C)
        TYPE(MPI_Win) :: win
        INTEGER :: error_code
```

[In Fortran] With the Fortran `mpi` module and `mpif.h`, the user routine `WIN_ERRHANDLER_FN` should be of the form:

```
SUBROUTINE WIN_ERRHANDLER_FUNCTION(WIN, ERROR_CODE)
    INTEGER WIN, ERROR_CODE
```

In C++, the user routine should be of the form:

```
{typedef void MPI::Win::Errhandler_function(MPI::Win &, int *, ...);
    (binding deprecated, see Section 15.2)}
```

```
MPI_WIN_SET_ERRHANDLER(win, errhandler)
```

INOUT	win	window (handle)
IN	errhandler	new error handler for window (handle)

```
int MPI_Win_set_errhandler(MPI_Win win, MPI_Errhandler errhandler)
```

```
MPI_Win_set_errhandler(win, errhandler, ierror) BIND(C)
    TYPE(MPI_Win), INTENT(IN) :: win
    TYPE(MPI_Errhandler), INTENT(IN) :: errhandler
    INTEGER, OPTIONAL, INTENT(OUT) :: ierror
```

```
MPI_WIN_SET_ERRHANDLER(WIN, ERRHANDLER, IERROR)
    INTEGER WIN, ERRHANDLER, IERROR
```

```
{void MPI::Win::Set_errhandler(const MPI::Errhandler& errhandler) (binding
    deprecated, see Section 15.2) }
```

Attaches a new error handler to a window. The error handler must be either a pre-defined error handler, or an error handler created by a call to `MPI_WIN_CREATE_ERRHANDLER`.

```

1 MPI_WIN_GET_ERRHANDLER(win, errhandler)
2     IN        win                window (handle)
3
4     OUT       errhandler          error handler currently associated with window (han-
5                                     dle)
6

```

```

7 int MPI_Win_get_errhandler(MPI_Win win, MPI_Errhandler *errhandler)

```

```

8 MPI_Win_get_errhandler(win, errhandler, ierror) BIND(C)
9     TYPE(MPI_Win), INTENT(IN) :: win
10    TYPE(MPI_Errhandler), INTENT(OUT) :: errhandler
11    INTEGER, OPTIONAL, INTENT(OUT) :: ierror
12

```

```

13 MPI_WIN_GET_ERRHANDLER(WIN, ERRHANDLER, IERROR)
14     INTEGER WIN, ERRHANDLER, IERROR

```

```

15 {MPI::Errhandler MPI::Win::Get_errhandler() const(binding deprecated, see
16     Section 15.2) }
17

```

Retrieves the error handler currently associated with a window.

8.3.3 Error Handlers for Files

```

23 MPI_FILE_CREATE_ERRHANDLER([function]file_errhandler_fn, errhandler)
24
25     IN        [ticket252-W.][function]file_errhandler_fn user defined error handling procedure (func-
26                                     tion)
27
28     OUT       errhandler          MPI error handler (handle)

```

```

29 int MPI_File_create_errhandler(MPI_File_errhandler_function
30     * [function]file_errhandler_fn, MPI_Errhandler *errhandler)

```

```

31 MPI_File_create_errhandler(file_errhandler_fn, errhandler, ierror) BIND(C)
32     PROCEDURE(MPI_File_errhandler_function) :: file_errhandler_fn
33     TYPE(MPI_Errhandler), INTENT(OUT) :: errhandler
34     INTEGER, OPTIONAL, INTENT(OUT) :: ierror
35

```

```

36 MPI_FILE_CREATE_ERRHANDLER([FUNCTION]FILE_ERRHANDLER_FN, ERRHANDLER,
37     IERROR)

```

```

38     EXTERNAL [FUNCTION]FILE_ERRHANDLER_FN
39     INTEGER ERRHANDLER, IERROR

```

```

40 {static MPI::Errhandler
41     MPI::File::Create_errhandler(MPI::File::Errhandler_function*
42     [function]file_errhandler_fn) (binding deprecated, see Section 15.2) }

```

Creates an error handler that can be attached to a file object. The user routine should be, in C, a function of type `MPI_File_errhandler_function`, which is defined as

```

46 typedef void MPI_File_errhandler_function(MPI_File *, int *, ...);

```

The first argument is the file in use, the second is the error code to be returned.

With the Fortran `mpi_f08` module, the user routine `file_errhandler_fn` should be of the form:

ABSTRACT INTERFACE

```
SUBROUTINE MPI_File_errhandler_function(file, error_code) BIND(C)
  TYPE(MPI_File) :: file
  INTEGER :: error_code
```

[In Fortran] With the Fortran `mpi` module and `mpif.h`, the user routine `FILE_ERRHANDLER_FN` should be of the form:

```
SUBROUTINE FILE_ERRHANDLER_FUNCTION(FILE, ERROR_CODE)
  INTEGER FILE, ERROR_CODE
```

In C++, the user routine should be of the form:

```
{typedef void MPI::File::Errhandler_function(MPI::File &, int *, ...);
  (binding deprecated, see Section 15.2)}
```

`MPI_FILE_SET_ERRHANDLER(file, errhandler)`

INOUT	file	file (handle)
IN	errhandler	new error handler for file (handle)

```
int MPI_File_set_errhandler(MPI_File file, MPI_Errhandler errhandler)
```

```
MPI_File_set_errhandler(file, errhandler, ierror) BIND(C)
  TYPE(MPI_File), INTENT(IN) :: file
  TYPE(MPI_Errhandler), INTENT(IN) :: errhandler
  INTEGER, OPTIONAL, INTENT(OUT) :: ierror
```

```
MPI_FILE_SET_ERRHANDLER(FILE, ERRHANDLER, IERROR)
  INTEGER FILE, ERRHANDLER, IERROR
```

```
{void MPI::File::Set_errhandler(const MPI::Errhandler& errhandler) (binding
  deprecated, see Section 15.2) }
```

Attaches a new error handler to a file. The error handler must be either a predefined error handler, or an error handler created by a call to `MPI_FILE_CREATE_ERRHANDLER`.

`MPI_FILE_GET_ERRHANDLER(file, errhandler)`

IN	file	file (handle)
OUT	errhandler	error handler currently associated with file (handle)

```
int MPI_File_get_errhandler(MPI_File file, MPI_Errhandler *errhandler)
```

```
MPI_File_get_errhandler(file, errhandler, ierror) BIND(C)
  TYPE(MPI_File), INTENT(IN) :: file
  TYPE(MPI_Errhandler), INTENT(OUT) :: errhandler
  INTEGER, OPTIONAL, INTENT(OUT) :: ierror
```

1 ticket230-B.

2 ticket-248T.

3

4

5

6

7

ticket230-B.

ticket230-B.

9

10

11

12

13

14

15

16

17

18

19

20

21

22

23

24 ticket-248T.

25

26

27

28

29

30

31

32

33

34

35

36

37

38

39

40

41

42

43

44 ticket-248T.

45

46

47

48

```

1 MPI_FILE_GET_ERRHANDLER(FILE, ERRHANDLER, IERROR)
2     INTEGER FILE, ERRHANDLER, IERROR
3
4 {MPI::Errhandler MPI::File::Get_errhandler() const(binding deprecated, see
5     Section 15.2) }
```

Retrieves the error handler currently associated with a file.

8.3.4 Freeing Errorhandlers and Retrieving Error Strings

```

11 MPI_ERRHANDLER_FREE( errhandler )
12
13     INOUT    errhandler          MPI error handler (handle)
```

```

15 int MPI_Errhandler_free(MPI_Errhandler *errhandler)
```

```

16 MPI_Errhandler_free(errhandler, ierror) BIND(C)
17     TYPE(MPI_Errhandler), INTENT(INOUT) :: errhandler
18     INTEGER, OPTIONAL, INTENT(OUT) :: ierror
```

```

20 MPI_ERRHANDLER_FREE(ERRHANDLER, IERROR)
21     INTEGER ERRHANDLER, IERROR
```

```

22 {void MPI::Errhandler::Free()(binding deprecated, see Section 15.2) }
```

Marks the error handler associated with `errhandler` for deallocation and sets `errhandler` to `MPI_ERRHANDLER_NULL`. The error handler will be deallocated after all the objects associated with it (communicator, window, or file) have been deallocated.

```

29 MPI_ERROR_STRING( errorcode, string, resultlen )
30
31     IN        errorcode          Error code returned by an MPI routine
32     OUT       string             Text that corresponds to the errorcode
33     OUT       resultlen         Length (in printable characters) of the result returned
34                                     in string
```

```

36 int MPI_Error_string(int errorcode, char *string, int *resultlen)
```

```

37 MPI_Error_string(errorcode, string, resultlen, ierror) BIND(C)
38     INTEGER, INTENT(IN) :: errorcode
39     CHARACTER(LEN=MPI_MAX_ERROR_STRING), INTENT(OUT) :: string
40     INTEGER, INTENT(OUT) :: resultlen
41     INTEGER, OPTIONAL, INTENT(OUT) :: ierror
```

```

43 MPI_ERROR_STRING(ERRORCODE, STRING, RESULTLEN, IERROR)
44     INTEGER ERRORCODE, RESULTLEN, IERROR
45     CHARACTER*(*) STRING
```

```

46 {void MPI::Get_error_string(int errorcode, char* name,
47     int& resultlen)(binding deprecated, see Section 15.2) }
```

Returns the error string associated with an error code or class. The argument `string` must represent storage that is at least `MPI_MAX_ERROR_STRING` characters long.

The number of characters actually written is returned in the output argument, `resultlen`.

Rationale. The form of this function was chosen to make the Fortran and C bindings similar. A version that returns a pointer to a string has two difficulties. First, the return string must be statically allocated and different for each error message (allowing the pointers returned by successive calls to `MPI_ERROR_STRING` to point to the correct message). Second, in Fortran, a function declared as returning `CHARACTER*(*)` can not be referenced in, for example, a `PRINT` statement. (*End of rationale.*)

8.4 Error Codes and Classes

The error codes returned by MPI are left entirely to the implementation (with the exception of `MPI_SUCCESS`). This is done to allow an implementation to provide as much information as possible in the error code (for use with `MPI_ERROR_STRING`).

To make it possible for an application to interpret an error code, the routine `MPI_ERROR_CLASS` converts any error code into one of a small set of standard error codes, called *error classes*. Valid error classes are shown in Table 8.1 and Table 8.2.

The error classes are a subset of the error codes: an MPI function may return an error class number; and the function `MPI_ERROR_STRING` can be used to compute the error string associated with an error class. An MPI error class is a valid MPI error code. Specifically, the values defined for MPI error classes are valid MPI error codes.

The error codes satisfy,

$$0 = \text{MPI_SUCCESS} < \text{MPI_ERR_...} \leq \text{MPI_ERR_LASTCODE}.$$

Rationale. The difference between `MPI_ERR_UNKNOWN` and `MPI_ERR_OTHER` is that `MPI_ERROR_STRING` can return useful information about `MPI_ERR_OTHER`.

Note that `MPI_SUCCESS = 0` is necessary to be consistent with C practice; the separation of error classes and error codes allows us to define the error classes this way. Having a known `LASTCODE` is often a nice sanity check as well. (*End of rationale.*)

```
MPI_ERROR_CLASS( errorcode, errorclass )
```

IN	errorcode	Error code returned by an MPI routine
OUT	errorclass	Error class associated with errorcode

```
int MPI_Error_class(int errorcode, int *errorclass)
```

```
MPI_Error_class(errorcode, errorclass, ierror) BIND(C)
  INTEGER, INTENT(IN) :: errorcode
  INTEGER, INTENT(OUT) :: errorclass
  INTEGER, OPTIONAL, INTENT(OUT) :: ierror
```

```
MPI_ERROR_CLASS(ERRORCODE, ERRORCLASS, IERROR)
  INTEGER ERRORCODE, ERRORCLASS, IERROR
```

ticket-248T.

1		
2		
3	MPI_SUCCESS	No error
4	MPI_ERR_BUFFER	Invalid buffer pointer
5	MPI_ERR_COUNT	Invalid count argument
6	MPI_ERR_TYPE	Invalid datatype argument
7	MPI_ERR_TAG	Invalid tag argument
8	MPI_ERR_COMM	Invalid communicator
9	MPI_ERR_RANK	Invalid rank
10	MPI_ERR_REQUEST	Invalid request (handle)
11	MPI_ERR_ROOT	Invalid root
12	MPI_ERR_GROUP	Invalid group
13	MPI_ERR_OP	Invalid operation
14	MPI_ERR_TOPOLOGY	Invalid topology
15	MPI_ERR_DIMS	Invalid dimension argument
16	MPI_ERR_ARG	Invalid argument of some other kind
17	MPI_ERR_UNKNOWN	Unknown error
18	MPI_ERR_TRUNCATE	Message truncated on receive
19	MPI_ERR_OTHER	Known error not in this list
20	MPI_ERR_INTERN	Internal MPI (implementation) error
21	MPI_ERR_IN_STATUS	Error code is in status
22	MPI_ERR_PENDING	Pending request
23	MPI_ERR_KEYVAL	Invalid keyval has been passed
24	MPI_ERR_NO_MEM	MPI_ALLOC_MEM failed because memory
25		is exhausted
26	MPI_ERR_BASE	Invalid base passed to MPI_FREE_MEM
27	MPI_ERR_INFO_KEY	Key longer than MPI_MAX_INFO_KEY
28	MPI_ERR_INFO_VALUE	Value longer than MPI_MAX_INFO_VAL
29	MPI_ERR_INFO_NOKEY	Invalid key passed to MPI_INFO_DELETE
30	MPI_ERR_SPAWN	Error in spawning processes
31	MPI_ERR_PORT	Invalid port name passed to
32		MPI_COMM_CONNECT
33	MPI_ERR_SERVICE	Invalid service name passed to
34		MPI_UNPUBLISH_NAME
35	MPI_ERR_NAME	Invalid service name passed to
36		MPI_LOOKUP_NAME
37	MPI_ERR_WIN	Invalid win argument
38	MPI_ERR_SIZE	Invalid size argument
39	MPI_ERR_DISP	Invalid disp argument
40	MPI_ERR_INFO	Invalid info argument
41	MPI_ERR_LOCKTYPE	Invalid locktype argument
42	MPI_ERR_ASSERT	Invalid assert argument
43	MPI_ERR_RMA_CONFLICT	Conflicting accesses to window
44	MPI_ERR_RMA_SYNC	Wrong synchronization of RMA calls
45		
46		
47		
48		

Table 8.1: Error classes (Part 1)

MPI_ERR_FILE	Invalid file handle	1
MPI_ERR_NOT_SAME	Collective argument not identical on all processes, or collective routines called in a different order by different processes	2 3 4
MPI_ERR_AMODE	Error related to the amode passed to MPI_FILE_OPEN	5 6
MPI_ERR_UNSUPPORTED_DATAREP	Unsupported datarep passed to MPI_FILE_SET_VIEW	7 8
MPI_ERR_UNSUPPORTED_OPERATION	Unsupported operation, such as seeking on a file which supports sequential access only	9 10
MPI_ERR_NO_SUCH_FILE	File does not exist	11
MPI_ERR_FILE_EXISTS	File exists	12
MPI_ERR_BAD_FILE	Invalid file name (e.g., path name too long)	13
MPI_ERR_ACCESS	Permission denied	14
MPI_ERR_NO_SPACE	Not enough space	15
MPI_ERR_QUOTA	Quota exceeded	16
MPI_ERR_READ_ONLY	Read-only file or file system	17
MPI_ERR_FILE_IN_USE	File operation could not be completed, as the file is currently open by some process	18 19
MPI_ERR_DUP_DATAREP	Conversion functions could not be registered because a data representation identifier that was already defined was passed to MPI_REGISTER_DATAREP	20 21 22 23
MPI_ERR_CONVERSION	An error occurred in a user supplied data conversion function.	24 25
MPI_ERR_IO	Other I/O error	26
MPI_ERR_LASTCODE	Last error code	27

Table 8.2: Error classes (Part 2)

```
{int MPI::Get_error_class(int errorcode) (binding deprecated, see Section 15.2) }
```

The function MPI_ERROR_CLASS maps each standard error code (error class) onto itself.

8.5 Error Classes, Error Codes, and Error Handlers

Users may want to write a layered library on top of an existing MPI implementation, and this library may have its own set of error codes and classes. An example of such a library is an I/O library based on MPI, see Chapter 13 on page 513. For this purpose, functions are needed to:

1. add a new error class to the ones an MPI implementation already knows.
2. associate error codes with this error class, so that MPI_ERROR_CLASS works.
3. associate strings with these error codes, so that MPI_ERROR_STRING works.
4. invoke the error handler associated with a communicator, window, or object.

Several functions are provided to do this. They are all local. No functions are provided to free error classes or codes: it is not expected that an application will generate them in significant numbers.

```
MPI_ADD_ERROR_CLASS(errorclass)
```

```
OUT      errorclass          value for the new error class (integer)
```

```
int MPI_Add_error_class(int *errorclass)
```

```
MPI_Add_error_class(errorclass, ierror) BIND(C)
```

```
INTEGER, INTENT(OUT) :: errorclass
```

```
INTEGER, OPTIONAL, INTENT(OUT) :: ierror
```

```
MPI_ADD_ERROR_CLASS(ERRORCLASS, IERROR)
```

```
INTEGER ERRORCLASS, IERROR
```

```
{int MPI::Add_error_class() (binding deprecated, see Section 15.2) }
```

Creates a new error class and returns the value for it.

Rationale. To avoid conflicts with existing error codes and classes, the value is set by the implementation and not by the user. (*End of rationale.*)

Advice to implementors. A high-quality implementation will return the value for a new `errorclass` in the same deterministic way on all processes. (*End of advice to implementors.*)

Advice to users. Since a call to `MPI_ADD_ERROR_CLASS` is local, the same `errorclass` may not be returned on all processes that make this call. Thus, it is not safe to assume that registering a new error on a set of processes at the same time will yield the same `errorclass` on all of the processes. However, if an implementation returns the new `errorclass` in a deterministic way, and they are always generated in the same order on the same set of processes (for example, all processes), then the value will be the same. However, even if a deterministic algorithm is used, the value can vary across processes. This can happen, for example, if different but overlapping groups of processes make a series of calls. As a result of these issues, getting the “same” error on multiple processes may not cause the same value of error code to be generated. (*End of advice to users.*)

The value of `MPI_ERR_LASTCODE` is a constant value and is not affected by new user-defined error codes and classes. Instead, a predefined attribute key `MPI_LASTUSED` is associated with `MPI_COMM_WORLD`. The attribute value corresponding to this key is the current maximum error class including the user-defined ones. This is a local value and may be different on different processes. The value returned by this key is always greater than or equal to `MPI_ERR_LASTCODE`.

Advice to users. The value returned by the key `MPI_LASTUSED` will not change unless the user calls a function to explicitly add an error class/code. In a multi-threaded environment, the user must take extra care in assuming this value has not

changed. Note that error codes and error classes are not necessarily dense. A user may not assume that each error class below MPI_LASTUSED_CODE is valid. (*End of advice to users.*)

MPI_ADD_ERROR_CODE(errorclass, errorcode)

IN	errorclass	error class (integer)
OUT	errorcode	new error code to associated with errorclass (integer)

int MPI_Add_error_code(int errorclass, int *errorcode)

MPI_Add_error_code(errorclass, errorcode, ierror) BIND(C)

INTEGER, INTENT(IN) :: errorclass

INTEGER, INTENT(OUT) :: errorcode

INTEGER, OPTIONAL, INTENT(OUT) :: ierror

MPI_ADD_ERROR_CODE(ERRORCLASS, ERRORCODE, IERROR)

INTEGER ERRORCLASS, ERRORCODE, IERROR

{int MPI::Add_error_code(int errorclass) (*binding deprecated, see Section 15.2*) }

Creates new error code associated with errorclass and returns its value in errorcode.

Rationale. To avoid conflicts with existing error codes and classes, the value of the new error code is set by the implementation and not by the user. (*End of rationale.*)

Advice to implementors. A high-quality implementation will return the value for a new errorcode in the same deterministic way on all processes. (*End of advice to implementors.*)

MPI_ADD_ERROR_STRING(errorcode, string)

IN	errorcode	error code or class (integer)
----	-----------	-------------------------------

IN	string	text corresponding to errorcode (string)
----	--------	--

int MPI_Add_error_string(int errorcode, const char *string)

MPI_Add_error_string(errorcode, string, ierror) BIND(C)

INTEGER, INTENT(IN) :: errorcode

CHARACTER(LEN=*), INTENT(IN) :: string

INTEGER, OPTIONAL, INTENT(OUT) :: ierror

MPI_ADD_ERROR_STRING(ERRORCODE, STRING, IERROR)

INTEGER ERRORCODE, IERROR

CHARACTER*(*) STRING

{void MPI::Add_error_string(int errorcode, const char* string) (*binding deprecated, see Section 15.2*) }

1 Associates an error string with an error code or class. The string must be no more
 2 than MPI_MAX_ERROR_STRING characters long. The length of the string is as defined in
 3 the calling language. The length of the string does not include the null terminator in C
 4 or C++. Trailing blanks will be stripped in Fortran. Calling MPI_ADD_ERROR_STRING
 5 for an errorcode that already has a string will replace the old string with the new string.
 6 It is erroneous to call MPI_ADD_ERROR_STRING for an error code or class with a value
 7 \leq MPI_ERR_LASTCODE.

8 If MPI_ERROR_STRING is called when no string has been set, it will return a empty
 9 string (all spaces in Fortran, "" in C and C++).

10 Section 8.3 on page 358 describes the methods for creating and associating error han-
 11 dlers with communicators, files, and windows.

12
 13
 14 MPI_COMM_CALL_ERRHANDLER (comm, errorcode)

15 IN comm communicator with error handler (handle)

16 IN errorcode error code (integer)

17
 18
 19 int MPI_Comm_call_errhandler(MPI_Comm comm, int errorcode)

20 ticket-248T. 21 MPI_Comm_call_errhandler(comm, errorcode, ierror) BIND(C)

22 TYPE(MPI_Comm), INTENT(IN) :: comm

23 INTEGER, INTENT(IN) :: errorcode

24 INTEGER, OPTIONAL, INTENT(OUT) :: ierror

25 MPI_COMM_CALL_ERRHANDLER(COMM, ERRORCODE, IERROR)

26 INTEGER COMM, ERRORCODE, IERROR

27
 28 {void MPI::Comm::Call_errhandler(int errorcode) const(*binding deprecated, see*
 29 *Section 15.2*) }

30 This function invokes the error handler assigned to the communicator with the error
 31 code supplied. This function returns MPI_SUCCESS in C and C++ and the same value in
 32 IERROR if the error handler was successfully called (assuming the process is not aborted
 33 and the error handler returns).

34
 35 *Advice to users.* Users should note that the default error handler is
 36 MPI_ERRORS_ARE_FATAL. Thus, calling MPI_COMM_CALL_ERRHANDLER will abort
 37 the comm processes if the default error handler has not been changed for this com-
 38 municator or on the parent before the communicator was created. (*End of advice to*
 39 *users.*)

40
 41
 42 MPI_WIN_CALL_ERRHANDLER (win, errorcode)

43 IN win window with error handler (handle)

44 IN errorcode error code (integer)

45
 46
 47 int MPI_Win_call_errhandler(MPI_Win win, int errorcode)

48 ticket-248T.

```

MPI_Win_call_errhandler(win, errorcode, ierror) BIND(C)
    TYPE(MPI_Win), INTENT(IN) :: win
    INTEGER, INTENT(IN) :: errorcode
    INTEGER, OPTIONAL, INTENT(OUT) :: ierror

```

```

MPI_WIN_CALL_ERRHANDLER(WIN, ERRORCODE, IERROR)
    INTEGER WIN, ERRORCODE, IERROR

```

```

{void MPI::Win::Call_errhandler(int errorcode) const(binding deprecated, see
    Section 15.2) }

```

This function invokes the error handler assigned to the window with the error code supplied. This function returns MPI_SUCCESS in C and C++ and the same value in IERROR if the error handler was successfully called (assuming the process is not aborted and the error handler returns).

Advice to users. As with communicators, the default error handler for windows is MPI_ERRORS_ARE_FATAL. (*End of advice to users.*)

```

MPI_FILE_CALL_ERRHANDLER (fh, errorcode)

```

```

    IN      fh                file with error handler (handle)
    IN      errorcode         error code (integer)

```

```

int MPI_File_call_errhandler(MPI_File fh, int errorcode)

```

```

MPI_File_call_errhandler(fh, errorcode, ierror) BIND(C)
    TYPE(MPI_File), INTENT(IN) :: fh
    INTEGER, INTENT(IN) :: errorcode
    INTEGER, OPTIONAL, INTENT(OUT) :: ierror

```

```

MPI_FILE_CALL_ERRHANDLER(FH, ERRORCODE, IERROR)
    INTEGER FH, ERRORCODE, IERROR

```

```

{void MPI::File::Call_errhandler(int errorcode) const(binding deprecated, see
    Section 15.2) }

```

This function invokes the error handler assigned to the file with the error code supplied. This function returns MPI_SUCCESS in C and C++ and the same value in IERROR if the error handler was successfully called (assuming the process is not aborted and the error handler returns).

Advice to users. Unlike errors on communicators and windows, the default behavior for files is to have MPI_ERRORS_RETURN. (*End of advice to users.*)

Advice to users. Users are warned that handlers should not be called recursively with MPI_COMM_CALL_ERRHANDLER, MPI_FILE_CALL_ERRHANDLER, or MPI_WIN_CALL_ERRHANDLER. Doing this can create a situation where an infinite recursion is created. This can occur if MPI_COMM_CALL_ERRHANDLER, MPI_FILE_CALL_ERRHANDLER, or MPI_WIN_CALL_ERRHANDLER is called inside an error handler.

1 Error codes and classes are associated with a process. As a result, they may be used
 2 in any error handler. Error handlers should be prepared to deal with any error code
 3 they are given. Furthermore, it is good practice to only call an error handler with the
 4 appropriate error codes. For example, file errors would normally be sent to the file
 5 error handler. (*End of advice to users.*)

8.6 Timers and Synchronization

9 MPI defines a timer. A timer is specified even though it is not “message-passing,” because
 10 timing parallel programs is important in “performance debugging” and because existing
 11 timers (both in POSIX 1003.1-1988 and 1003.4D 14.1 and in Fortran 90) are either incon-
 12 venient or do not provide adequate access to high-resolution timers. See also Section 2.6.5
 13 on page 23.

MPI_WTIME()

16 double MPI_Wtime(void)

18 **DOUBLE PRECISION MPI_Wtime() BIND(C)**

20 DOUBLE PRECISION MPI_WTIME()

22 {double MPI::Wtime() (*binding deprecated, see Section 15.2*) }

24 MPI_WTIME returns a floating-point number of seconds, representing elapsed wall-
 25 clock time since some time in the past.

26 The “time in the past” is guaranteed not to change during the life of the process.
 27 The user is responsible for converting large numbers of seconds to other units if they are
 28 preferred.

29 This function is portable (it returns seconds, not “ticks”), it allows high-resolution,
 30 and carries no unnecessary baggage. One would use it like this:

```
31 {
32     double starttime, endtime;
33     starttime = MPI_Wtime();
34     .... stuff to be timed ...
35     endtime = MPI_Wtime();
36     printf("That took %f seconds\n",endtime-starttime);
37 }
38 }
```

39 The times returned are local to the node that called them. There is no requirement
 40 that different nodes return “the same time.” (But see also the discussion of
 41 MPI_WTIME_IS_GLOBAL).

MPI_WTICK()

44 double MPI_Wtick(void)

46 **DOUBLE PRECISION MPI_Wtick() BIND(C)**

```
DOUBLE PRECISION MPI_WTICK()
```

```
{double MPI::Wtick() (binding deprecated, see Section 15.2) }
```

MPI_WTICK returns the resolution of MPI_WTIME in seconds. That is, it returns, as a double precision value, the number of seconds between successive clock ticks. For example, if the clock is implemented by the hardware as a counter that is incremented every millisecond, the value returned by MPI_WTICK should be 10^{-3} .

8.7 Startup

One goal of MPI is to achieve *source code portability*. By this we mean that a program written using MPI and complying with the relevant language standards is portable as written, and must not require any source code changes when moved from one system to another. This explicitly does *not* say anything about how an MPI program is started or launched from the command line, nor what the user must do to set up the environment in which an MPI program will run. However, an implementation may require some setup to be performed before other MPI routines may be called. To provide for this, MPI includes an initialization routine MPI_INIT.

```
MPI_INIT()
```

```
int MPI_Init(int *argc, char ***argv)
```

```
MPI_Init(ierr) BIND(C)
    INTEGER, OPTIONAL, INTENT(OUT) :: ierr
```

```
MPI_INIT(IERROR)
    INTEGER IERROR
```

```
{void MPI::Init(int& argc, char**& argv) (binding deprecated, see Section 15.2) }
```

```
{void MPI::Init() (binding deprecated, see Section 15.2) }
```

All MPI programs must contain exactly one call to an MPI initialization routine: MPI_INIT or MPI_INIT_THREAD. Subsequent calls to any initialization routines are erroneous. The only MPI functions that may be invoked before the MPI initialization routines are called are MPI_GET_VERSION, `[MPI_GET_LIBRARY_VERSION, MPI_INITIALIZED, [and] MPI_FINALIZED]`, and any function with the prefix MPI_T_* (within the constraints for functions with this prefix listed in Section 14.3.4). The version for ISO C accepts the argc and argv that are provided by the arguments to main or NULL:

```
int main(int argc, char **argv)
{
    MPI_Init(&argc, &argv);

    /* parse arguments */
    /* main program */

    MPI_Finalize(); /* see below */
}
```

1 The Fortran version takes only IERROR.

2 Conforming implementations of MPI are required to allow applications to pass NULL
3 for both the `argc` and `argv` arguments of `main` in C and C++. In C++, there is an alternative
4 binding for `MPI::Init` that does not have these arguments at all.

5
6 *Rationale.* In some applications, libraries may be making the call to
7 `MPI_Init`, and may not have access to `argc` and `argv` from `main`. It is anticipated
8 that applications requiring special information about the environment or information
9 supplied by `mpiexec` can get that information from environment variables. (*End of*
10 *rationale.*)

11
12
13 `MPI_FINALIZE()`

14
15 `int MPI_Finalize(void)`

16
17 `MPI_Finalize(ierror) BIND(C)`
18 `INTEGER, OPTIONAL, INTENT(OUT) :: ierror`

19
20 `MPI_FINALIZE(IERROR)`
21 `INTEGER IERROR`

22 `{void MPI::Finalize() (binding deprecated, see Section 15.2) }`

23
24 This routine cleans up all MPI state. Each process must call `MPI_FINALIZE` before
25 it exits. Unless there has been a call to `MPI_ABORT`, each process must ensure that all
26 pending nonblocking communications are (locally) complete before calling `MPI_FINALIZE`.
27 Further, at the instant at which the last process calls `MPI_FINALIZE`, all pending sends
28 must be matched by a receive, and all pending receives must be matched by a send.

29 For example, the following program is correct:

30
31

Process 0	Process 1
-----	-----
<code>MPI_Init();</code>	<code>MPI_Init();</code>
<code>MPI_Send(dest=1);</code>	<code>MPI_Recv(src=0);</code>
<code>MPI_Finalize();</code>	<code>MPI_Finalize();</code>

35
36 Without the matching receive, the program is erroneous:

37
38

Process 0	Process 1
-----	-----
<code>MPI_Init();</code>	<code>MPI_Init();</code>
<code>MPI_Send (dest=1);</code>	
<code>MPI_Finalize();</code>	<code>MPI_Finalize();</code>

39
40
41
42
43 A successful return from a blocking communication operation or from `MPI_WAIT` or
44 `MPI_TEST` tells the user that the buffer can be reused and means that the communication
45 is completed by the user, but does not guarantee that the local process has no more work
46 to do. A successful return from `MPI_REQUEST_FREE` with a request handle generated by
47 an `MPI_ISEND` nullifies the handle but provides no assurance of operation completion. The
48 `MPI_ISEND` is complete only when it is known by some means that a matching receive has

completed. `MPI_FINALIZE` guarantees that all local actions required by communications the user has completed will, in fact, occur before it returns.

`MPI_FINALIZE` guarantees nothing about pending communications that have not been completed (completion is assured only by `MPI_WAIT`, `MPI_TEST`, or `MPI_REQUEST_FREE` combined with some other verification of completion).

Example 8.4 This program is correct:

```
rank 0                                rank 1
=====
...
MPI_Isend();                          MPI_Recv();
MPI_Request_free();                   MPI_Barrier();
MPI_Barrier();                        MPI_Finalize();
MPI_Finalize();                       exit();
exit();
```

Example 8.5 This program is erroneous and its behavior is undefined:

```
rank 0                                rank 1
=====
...
MPI_Isend();                          MPI_Recv();
MPI_Request_free();                   MPI_Finalize();
MPI_Finalize();                       exit();
exit();
```

If no `MPI_BUFFER_DETACH` occurs between an `MPI_BSEND` (or other buffered send) and `MPI_FINALIZE`, the `MPI_FINALIZE` implicitly supplies the `MPI_BUFFER_DETACH`.

Example 8.6 This program is correct, and after the `MPI_Finalize`, it is as if the buffer had been detached.

```
rank 0                                rank 1
=====
...
buffer = malloc(1000000);             MPI_Recv();
MPI_Buffer_attach();                  MPI_Finalize();
MPI_Bsend();                          exit();
MPI_Finalize();
free(buffer);
exit();
```

Example 8.7 In this example, `MPI_lprobe()` must return a `FALSE` flag. `MPI_Test_cancelled()` must return a `TRUE` flag, independent of the relative order of execution of `MPI_Cancel()` in process 0 and `MPI_Finalize()` in process 1.

The `MPI_lprobe()` call is there to make sure the implementation knows that the “tag1” message exists at the destination, without being able to claim that the user knows about it.

```

1
2 rank 0                                rank 1
3 =====
4 MPI_Init();                            MPI_Init();
5 MPI_Isend(tag1);                        MPI_Barrier();
6 MPI_Barrier();                          MPI_Iprobe(tag2);
7                                          MPI_Barrier();
8 MPI_Barrier();                          MPI_Finalize();
9                                          exit();
10
11 MPI_Cancel();
12 MPI_Wait();
13 MPI_Test_cancelled();
14 MPI_Finalize();
15 exit();
16
17

```

Advice to implementors. An implementation may need to delay the return from MPI_FINALIZE until all potential future message cancellations have been processed. One possible solution is to place a barrier inside MPI_FINALIZE (*End of advice to implementors.*)

Once MPI_FINALIZE returns, no MPI routine (not even MPI_INIT) may be called, except for MPI_GET_VERSION, `[MPI_GET_LIBRARY_VERSION, MPI_INITIALIZED, [and] MPI_FINALIZED]`, and any function with the prefix MPI_T_* (within the constraints for functions with this prefix listed in Section 14.3.4). Each process must complete any pending communication it initiated before it calls MPI_FINALIZE. If the call returns, each process may continue local computations, or exit, without participating in further MPI communication with other processes. MPI_FINALIZE is collective over all connected processes. If no processes were spawned, accepted or connected then this means over MPI_COMM_WORLD; otherwise it is collective over the union of all processes that have been and continue to be connected, as explained in Section 10.5.4 on page 418.

Advice to implementors. Even though a process has completed all the communication it initiated, such communication may not yet be completed from the viewpoint of the underlying MPI system. E.g., a blocking send may have completed, even though the data is still buffered at the sender. The MPI implementation must ensure that a process has completed any involvement in MPI communication before MPI_FINALIZE returns. Thus, if a process exits after the call to MPI_FINALIZE, this will not cause an ongoing communication to fail. (*End of advice to implementors.*)

Although it is not required that all processes return from MPI_FINALIZE, it is required that at least process 0 in MPI_COMM_WORLD return, so that users can know that the MPI portion of the computation is over. In addition, in a POSIX environment, they may desire to supply an exit code for each process that returns from MPI_FINALIZE.

Example 8.8 The following illustrates the use of requiring that at least one process return and that it be known that process 0 is one of the processes that return. One wants code like the following to work no matter how many processes return.

```

...
MPI_Comm_rank(MPI_COMM_WORLD, &myrank);
...
MPI_Finalize();
if (myrank == 0) {
    resultfile = fopen("outfile","w");
    dump_results(resultfile);
    fclose(resultfile);
}
exit(0);

```

MPI_INITIALIZED(flag)

OUT flag Flag is true if MPI_INIT has been called and false otherwise.

int MPI_Initialized(int *flag)

MPI_Initialized(flag, ierror) BIND(C)
LOGICAL, INTENT(OUT) :: flag
INTEGER, OPTIONAL, INTENT(OUT) :: ierror

MPI_INITIALIZED(FLAG, IERROR)
LOGICAL FLAG
INTEGER IERROR

{bool MPI::Is_initialized() (*binding deprecated, see Section 15.2*) }

This routine may be used to determine whether MPI_INIT has been called. MPI_INITIALIZED returns true if the calling process has called MPI_INIT. Whether MPI_FINALIZE has been called does not affect the behavior of MPI_INITIALIZED. It is one of the few routines that may be called before MPI_INIT is called.

MPI_ABORT(comm, errorcode)

IN comm communicator of tasks to abort
IN errorcode error code to return to invoking environment

int MPI_Abort(MPI_Comm comm, int errorcode)

MPI_Abort(comm, errorcode, ierror) BIND(C)
TYPE(MPI_Comm), INTENT(IN) :: comm
INTEGER, INTENT(IN) :: errorcode
INTEGER, OPTIONAL, INTENT(OUT) :: ierror

MPI_ABORT(COMM, ERRORCODE, IERROR)
INTEGER COMM, ERRORCODE, IERROR

{void MPI::Comm::Abort(int errorcode) (*binding deprecated, see Section 15.2*) }

1 This routine makes a “best attempt” to abort all tasks in the group of `comm`. This
2 function does not require that the invoking environment take any action with the error
3 code. However, a Unix or POSIX environment should handle this as a `return errorcode`
4 from the main program.

5 It may not be possible for an MPI implementation to abort only the processes repre-
6 sented by `comm` if this is a subset of the processes. In this case, the MPI implementation
7 should attempt to abort all the connected processes but should not abort any unconnected
8 processes. If no processes were spawned, accepted or connected then this has the effect of
9 aborting all the processes associated with `MPI_COMM_WORLD`.

10
11 *Rationale.* The communicator argument is provided to allow for future extensions of
12 MPI to environments with, for example, dynamic process management. In particular,
13 it allows but does not require an MPI implementation to abort a subset of
14 `MPI_COMM_WORLD`. (*End of rationale.*)

15
16 *Advice to users.* Whether the errorcode is returned from the executable or from the
17 MPI process startup mechanism (e.g., `mpiexec`), is an aspect of quality of the MPI
18 library but not mandatory. (*End of advice to users.*)

19
20
21 *Advice to implementors.* Where possible, a high-quality implementation will try
22 to return the errorcode from the MPI process startup mechanism (e.g. `mpiexec` or
23 `singleton init`). (*End of advice to implementors.*)

24 8.7.1 Allowing User Functions at Process Termination

25
26 There are times in which it would be convenient to have actions happen when an MPI process
27 finishes. For example, a routine may do initializations that are useful until the MPI job (or
28 that part of the job that being terminated in the case of dynamically created processes) is
29 finished. This can be accomplished in MPI by attaching an attribute to `MPI_COMM_SELF`
30 with a callback function. When `MPI_FINALIZE` is called, it will first execute the equivalent
31 of an `MPI_COMM_FREE` on `MPI_COMM_SELF`. This will cause the delete callback function
32 to be executed on all keys associated with `MPI_COMM_SELF`, in the reverse order that
33 they were set on `MPI_COMM_SELF`. If no key has been attached to `MPI_COMM_SELF`, then
34 no callback is invoked. The “freeing” of `MPI_COMM_SELF` occurs before any other parts
35 of MPI are affected. Thus, for example, calling `MPI_FINALIZED` will return `false` in any
36 of these callback functions. Once done with `MPI_COMM_SELF`, the order and rest of the
37 actions taken by `MPI_FINALIZE` is not specified.

38
39 *Advice to implementors.* Since attributes can be added from any supported language,
40 the MPI implementation needs to remember the creating language so the correct
41 callback is made. Implementations that use the attribute delete callback on
42 `MPI_COMM_SELF` internally should register their internal callbacks before returning
43 from `MPI_INIT` / `MPI_INIT_THREAD`, so that libraries or applications will not have
44 portions of the MPI implementation shut down before the application-level callbacks
45 are made. (*End of advice to implementors.*)

8.7.2 Determining Whether MPI Has Finished

One of the goals of MPI was to allow for layered libraries. In order for a library to do this cleanly, it needs to know if MPI is active. In MPI the function `MPI_INITIALIZED` was provided to tell if MPI had been initialized. The problem arises in knowing if MPI has been finalized. Once MPI has been finalized it is no longer active and cannot be restarted. A library needs to be able to determine this to act accordingly. To achieve this the following function is needed:

```
MPI_FINALIZED(flag)
```

```
    OUT      flag                      true if MPI was finalized (logical)
```

```
int MPI_Finalized(int *flag)
```

```
MPI_Finalized(flag, ierror) BIND(C)
    LOGICAL, INTENT(OUT) :: flag
    INTEGER, OPTIONAL, INTENT(OUT) :: ierror
```

```
MPI_FINALIZED(FLAG, IERROR)
```

```
    LOGICAL FLAG
    INTEGER IERROR
```

```
{bool MPI::Is_finalized() (binding deprecated, see Section 15.2) }
```

This routine returns true if `MPI_FINALIZE` has completed. It is [\[legal\]valid](#) to call `MPI_FINALIZED` before `MPI_INIT` and after `MPI_FINALIZE`.

Advice to users. MPI is “active” and it is thus safe to call MPI functions if `MPI_INIT` has completed and `MPI_FINALIZE` has not completed. If a library has no other way of knowing whether MPI is active or not, then it can use `MPI_INITIALIZED` and `MPI_FINALIZED` to determine this. For example, MPI is “active” in callback functions that are invoked during `MPI_FINALIZE`. (*End of advice to users.*)

8.8 Portable MPI Process Startup

A number of implementations of MPI provide a startup command for MPI programs that is of the form

```
mpirun <mpirun arguments> <program> <program arguments>
```

Separating the command to start the program from the program itself provides flexibility, particularly for network and heterogeneous implementations. For example, the startup script need not run on one of the machines that will be executing the MPI program itself.

Having a standard startup mechanism also extends the portability of MPI programs one step further, to the command lines and scripts that manage them. For example, a validation suite script that runs hundreds of programs can be a portable script if it is written using such a standard startup mechanism. In order that the “standard” command not be confused with existing practice, which is not standard and not portable among implementations, instead of `mpirun` MPI specifies `mpiexec`.

1
2
3
4
5
6
7
8
9
10
11
12
13
14
15 ticket-248T.
16
17
18
19
20
21
22
23
24 ticket182.
25
26
27
28
29
30
31
32
33
34
35
36
37
38
39
40
41
42
43
44
45
46
47
48

1 While a standardized startup mechanism improves the usability of MPI, the range of
 2 environments is so diverse (e.g., there may not even be a command line interface) that MPI
 3 cannot mandate such a mechanism. Instead, MPI specifies an `mpiexec` startup command
 4 and recommends but does not require it, as advice to implementors. However, if an im-
 5 plementation does provide a command called `mpiexec`, it must be of the form described
 6 below.

7 It is suggested that

```
8 mpiexec -n <numprocs> <program>
```

9
 10 be at least one way to start `<program>` with an initial `MPI_COMM_WORLD` whose group
 11 contains `<numprocs>` processes. Other arguments to `mpiexec` may be implementation-
 12 dependent.

13
 14 *Advice to implementors.* Implementors, if they do provide a special startup command
 15 for MPI programs, are advised to give it the following form. The syntax is chosen in
 16 order that `mpiexec` be able to be viewed as a command-line version of
 17 `MPI_COMM_SPAWN` (See Section 10.3.4).

18 Analogous to `MPI_COMM_SPAWN`, we have

```
19  

  20  

  21 mpiexec -n <maxprocs>  

  22     -soft < >  

  23     -host < >  

  24     -arch < >  

  25     -wdir < >  

  26     -path < >  

  27     -file < >  

  28     ...  

  29     <command line>
```

30
 31 for the case where a single command line for the application program and its arguments
 32 will suffice. See Section 10.3.4 for the meanings of these arguments. For the case
 33 corresponding to `MPI_COMM_SPAWN_MULTIPLE` there are two possible formats:

34 Form A:

```
35  

  36 mpiexec { <above arguments> } : { ... } : { ... } : ... : { ... }
```

37
 38 As with `MPI_COMM_SPAWN`, all the arguments are optional. (Even the `-n x` argu-
 39 ment is optional; the default is implementation dependent. It might be 1, it might be
 40 taken from an environment variable, or it might be specified at compile time.) The
 41 names and meanings of the arguments are taken from the keys in the `info` argument
 42 to `MPI_COMM_SPAWN`. There may be other, implementation-dependent arguments
 43 as well.

44
 45 Note that Form A, though convenient to type, prevents colons from being program
 46 arguments. Therefore an alternate, file-based form is allowed:

47 Form B:

```
mpiexec -configfile <filename>
```

where the lines of <filename> are of the form separated by the colons in Form A. Lines beginning with '#' are comments, and lines may be continued by terminating the partial line with '\'.
 1
 2
 3
 4
 5
 6

Example 8.9 Start 16 instances of myprog on the current or default machine:
 7
 8

```
mpiexec -n 16 myprog
```

Example 8.10 Start 10 processes on the machine called ferrari:
 9
 10
 11
 12

```
mpiexec -n 10 -host ferrari myprog
```

Example 8.11 Start three copies of the same program with different command-line arguments:
 13
 14
 15
 16
 17
 18

```
mpiexec myprog infile1 : myprog infile2 : myprog infile3
```

Example 8.12 Start the ocean program on five Suns and the atmos program on 10 RS/6000's:
 19
 20
 21
 22
 23
 24

```
mpiexec -n 5 -arch sun ocean : -n 10 -arch rs6000 atmos
```

It is assumed that the implementation in this case has a method for choosing hosts of the appropriate type. Their ranks are in the order specified.
 25
 26
 27
 28
 29

Example 8.13 Start the ocean program on five Suns and the atmos program on 10 RS/6000's (Form B):
 30
 31
 32

```
mpiexec -configfile myfile
```

where myfile contains
 33
 34
 35
 36

```
-n 5 -arch sun ocean
-n 10 -arch rs6000 atmos
```

(End of advice to implementors.)
 37
 38
 39
 40
 41
 42
 43
 44
 45
 46
 47
 48

1
2
3
4
5
6
7
8
9
10
11
12
13
14
15
16
17
18
19
20
21
22
23
24
25
26
27
28
29
30
31
32
33
34
35
36
37
38
39
40
41
42
43
44
45
46
47
48

Chapter 9

The Info Object

Many of the routines in MPI take an argument `info`. `info` is an opaque object with a handle of type `MPI_Info` in C and Fortran with the `mpi_f08` module, `MPI::Info` in C++, and `INTEGER` in Fortran with the `mpi` module or the include file `mpif.h`. It stores an unordered set of (key,value) pairs (both key and value are strings). A key can have only one value. MPI reserves several keys and requires that if an implementation uses a reserved key, it must provide the specified functionality. An implementation is not required to support these keys and may support any others not reserved by MPI.

An implementation must support info objects as caches for arbitrary (key, value) pairs, regardless of whether it recognizes the key. Each function that takes hints in the form of an `MPI_Info` must be prepared to ignore any key it does not recognize. This description of info objects does not attempt to define how a particular function should react if it recognizes a key but not the associated value. `MPI_INFO_GET_NKEYS`, `MPI_INFO_GET_NTHKEY`, `MPI_INFO_GET_VALUELEN`, and `MPI_INFO_GET` must retain all (key,value) pairs so that layered functionality can also use the `Info` object.

Keys have an implementation-defined maximum length of `MPI_MAX_INFO_KEY`, which is at least 32 and at most 255. Values have an implementation-defined maximum length of `MPI_MAX_INFO_VAL`. In Fortran, leading and trailing spaces are stripped from both. Returned values will never be larger than these maximum lengths. Both key and value are case sensitive.

Rationale. Keys have a maximum length because the set of known keys will always be finite and known to the implementation and because there is no reason for keys to be complex. The small maximum size allows applications to declare keys of size `MPI_MAX_INFO_KEY`. The limitation on value sizes is so that an implementation is not forced to deal with arbitrarily long strings. (*End of rationale.*)

Advice to users. `MPI_MAX_INFO_VAL` might be very large, so it might not be wise to declare a string of that size. (*End of advice to users.*)

When it is an argument to a nonblocking routine, `info` is parsed before that routine returns, so that it may be modified or freed immediately after return.

When the descriptions refer to a key or value as being a boolean, an integer, or a list, they mean the string representation of these types. An implementation may define its own rules for how info value strings are converted to other types, but to ensure portability, every implementation must support the following representations. Legal values for a boolean must

1
2
3
4
5
6
7
8
9
10
11
12
13
14
15 ticket231-C.
16 ticket231-C.
17
18
19
20
21
22
23
24
25
26
27
28
29
30
31
32
33
34
35
36
37
38
39
40
41
42
43
44
45
46
47
48

1 include the strings “true” and “false” (all lowercase). For integers, legal values must include
 2 string representations of decimal values of integers that are within the range of a standard
 3 integer type in the program. (However it is possible that not every legal integer is a legal
 4 value for a given key.) On positive numbers, + signs are optional. No space may appear
 5 between a + or – sign and the leading digit of a number. For comma separated lists, the
 6 string must contain legal elements separated by commas. Leading and trailing spaces are
 7 stripped automatically from the types of info values described above and for each element of
 8 a comma separated list. These rules apply to all info values of these types. Implementations
 9 are free to specify a different interpretation for values of other info keys.

11 MPI_INFO_CREATE(info)

13 OUT info info object created (handle)

15 int MPI_Info_create(MPI_Info *info)

17 MPI_Info_create(info, ierror) BIND(C)
 18 TYPE(MPI_Info), INTENT(OUT) :: info
 19 INTEGER, OPTIONAL, INTENT(OUT) :: ierror

20 MPI_INFO_CREATE(INFO, IERROR)

21 INTEGER INFO, IERROR

23 {static MPI::Info MPI::Info::Create() (*binding deprecated, see Section 15.2*) }

24 MPI_INFO_CREATE creates a new info object. The newly created object contains no
 25 key/value pairs.

28 MPI_INFO_SET(info, key, value)

29 INOUT info info object (handle)

31 IN key key (string)

32 IN value value (string)

34 int MPI_Info_set(MPI_Info info, const char *key, const char *value)

36 MPI_Info_set(info, key, value, ierror) BIND(C)
 37 TYPE(MPI_Info), INTENT(IN) :: info
 38 CHARACTER(LEN=*), INTENT(IN) :: key, value
 39 INTEGER, OPTIONAL, INTENT(OUT) :: ierror

40 MPI_INFO_SET(INFO, KEY, VALUE, IERROR)

41 INTEGER INFO, IERROR

42 CHARACTER*(*) KEY, VALUE

44 {void MPI::Info::Set(const char* key, const char* value) (*binding deprecated,*
 45 *see Section 15.2*) }

46 MPI_INFO_SET adds the (key,value) pair to info, and overrides the value if a value for
 47 the same key was previously set. key and value are null-terminated strings in C. In Fortran,
 48

leading and trailing spaces in key and value are stripped. If either key or value are larger than the allowed maximums, the errors MPI_ERR_INFO_KEY or MPI_ERR_INFO_VALUE are raised, respectively.

MPI_INFO_DELETE(info, key)

INOUT	info	info object (handle)
IN	key	key (string)

```
int MPI_Info_delete(MPI_Info info, const char *key)
```

```
MPI_Info_delete(info, key, ierror) BIND(C)
    TYPE(MPI_Info), INTENT(IN) :: info
    CHARACTER(LEN=*), INTENT(IN) :: key
    INTEGER, OPTIONAL, INTENT(OUT) :: ierror
```

```
MPI_INFO_DELETE(INFO, KEY, IERROR)
```

```
    INTEGER INFO, IERROR
    CHARACTER*(*) KEY
```

```
{void MPI::Info::Delete(const char* key) (binding deprecated, see Section 15.2) }
```

MPI_INFO_DELETE deletes a (key,value) pair from info. If key is not defined in info, the call raises an error of class MPI_ERR_INFO_NOKEY.

MPI_INFO_GET(info, key, valuelen, value, flag)

IN	info	info object (handle)
IN	key	key (string)
IN	valuelen	length of value arg (integer)
OUT	value	value (string)
OUT	flag	true if key defined, false if not (boolean)

```
int MPI_Info_get(MPI_Info info, const char *key, int valuelen, char *value,
    int *flag)
```

```
MPI_Info_get(info, key, valuelen, value, flag, ierror) BIND(C)
    TYPE(MPI_Info), INTENT(IN) :: info
    CHARACTER(LEN=*), INTENT(IN) :: key
    INTEGER, INTENT(IN) :: valuelen
    CHARACTER(LEN=valuelen), INTENT(OUT) :: value
    LOGICAL, INTENT(OUT) :: flag
    INTEGER, OPTIONAL, INTENT(OUT) :: ierror
```

```
MPI_INFO_GET(INFO, KEY, VALUELEN, VALUE, FLAG, IERROR)
```

```
    INTEGER INFO, VALUELEN, IERROR
    CHARACTER*(*) KEY, VALUE
    LOGICAL FLAG
```

```

1  {bool MPI::Info::Get(const char* key, int valuelen, char* value)
2      const(binding deprecated, see Section 15.2) }
3

```

This function retrieves the value associated with `key` in a previous call to `MPI_INFO_SET`. If such a key exists, it sets `flag` to true and returns the value in `value`, otherwise it sets `flag` to false and leaves `value` unchanged. `valuelen` is the number of characters available in `value`. If it is less than the actual size of the value, the value is truncated. In C, `valuelen` should be one less than the amount of allocated space to allow for the null terminator.

If `key` is larger than `MPI_MAX_INFO_KEY`, the call is erroneous.

```

12 MPI_INFO_GET_VALUELEN(info, key, valuelen, flag)
13

```

14	IN	info	info object (handle)
15	IN	key	key (string)
16	OUT	valuelen	length of value arg (integer)
17	OUT	flag	true if key defined, false if not (boolean)

```

19
ticket140. 20 int MPI_Info_get_valuelen(MPI_Info info, const char *key, int *valuelen,
ticket-248T. 21 int *flag)
22

```

```

23 MPI_Info_get_valuelen(info, key, valuelen, flag, ierror) BIND(C)
24     TYPE(MPI_Info), INTENT(IN) :: info
25     CHARACTER(LEN=*), INTENT(IN) :: key
26     INTEGER, INTENT(OUT) :: valuelen
27     LOGICAL, INTENT(OUT) :: flag
28     INTEGER, OPTIONAL, INTENT(OUT) :: ierror
29

```

```

29 MPI_INFO_GET_VALUELEN(INFO, KEY, VALUELEN, FLAG, IERROR)
30     INTEGER INFO, VALUELEN, IERROR
31     LOGICAL FLAG
32     CHARACTER*(*) KEY
33

```

```

34 {bool MPI::Info::Get_valuelen(const char* key, int& valuelen) const(binding
35     deprecated, see Section 15.2) }
36

```

Retrieves the length of the value associated with `key`. If `key` is defined, `valuelen` is set to the length of its associated value and `flag` is set to true. If `key` is not defined, `valuelen` is not touched and `flag` is set to false. The length returned in C or C++ does not include the end-of-string character.

If `key` is larger than `MPI_MAX_INFO_KEY`, the call is erroneous.

```

42 MPI_INFO_GET_NKEYS(info, nkeys)
43

```

44	IN	info	info object (handle)
45	OUT	nkeys	number of defined keys (integer)

```

47 int MPI_Info_get_nkeys(MPI_Info info, int *nkeys)
48

```

ticket-248T.

```

MPI_Info_get_nkeys(info, nkeys, ierror) BIND(C)
    TYPE(MPI_Info), INTENT(IN) :: info
    INTEGER, INTENT(OUT) :: nkeys
    INTEGER, OPTIONAL, INTENT(OUT) :: ierror

MPI_INFO_GET_NKEYS(INFO, NKEYS, IERROR)
    INTEGER INFO, NKEYS, IERROR

{int MPI::Info::Get_nkeys() const(binding deprecated, see Section 15.2) }

MPI_INFO_GET_NKEYS returns the number of currently defined keys in info.

```

```

MPI_INFO_GET_NTHKEY(info, n, key)

```

IN	info	info object (handle)
IN	n	key number (integer)
OUT	key	key (string)

```

int MPI_Info_get_nthkey(MPI_Info info, int n, char *key)

```

```

MPI_Info_get_nthkey(info, n, key, ierror) BIND(C)
    TYPE(MPI_Info), INTENT(IN) :: info
    INTEGER, INTENT(IN) :: n
    CHARACTER(LEN=*), INTENT(OUT) :: key
    INTEGER, OPTIONAL, INTENT(OUT) :: ierror

```

```

MPI_INFO_GET_NTHKEY(INFO, N, KEY, IERROR)
    INTEGER INFO, N, IERROR
    CHARACTER*(*) KEY

```

```

{void MPI::Info::Get_nthkey(int n, char* key) const(binding deprecated, see
    Section 15.2) }

```

This function returns the n th defined key in `info`. Keys are numbered $0 \dots N - 1$ where N is the value returned by `MPI_INFO_GET_NKEYS`. All keys between 0 and $N - 1$ are guaranteed to be defined. The number of a given key does not change as long as `info` is not modified with `MPI_INFO_SET` or `MPI_INFO_DELETE`.

```

MPI_INFO_DUP(info, newinfo)

```

IN	info	info object (handle)
OUT	newinfo	info object (handle)

```

int MPI_Info_dup(MPI_Info info, MPI_Info *newinfo)

```

```

MPI_Info_dup(info, newinfo, ierror) BIND(C)
    TYPE(MPI_Info), INTENT(IN) :: info
    TYPE(MPI_Info), INTENT(OUT) :: newinfo
    INTEGER, OPTIONAL, INTENT(OUT) :: ierror

```

1 MPI_INFO_DUP(INFO, NEWINFO, IERROR)

2 INTEGER INFO, NEWINFO, IERROR

3 {MPI::Info MPI::Info::Dup() const(*binding deprecated, see Section 15.2*) }

4
5 MPI_INFO_DUP duplicates an existing info object, creating a new object, with the
6 same (key,value) pairs and the same ordering of keys.

7
8
9 MPI_INFO_FREE(info)

10 INOUT info info object (handle)

11
12
13 int MPI_Info_free(MPI_Info *info)

14 MPI_Info_free(info, ierror) BIND(C)

15 TYPE(MPI_Info), INTENT(INOUT) :: info

16 INTEGER, OPTIONAL, INTENT(OUT) :: ierror

17 MPI_INFO_FREE(INFO, IERROR)

18 INTEGER INFO, IERROR

19
20 {void MPI::Info::Free() (*binding deprecated, see Section 15.2*) }

21
22 This function frees info and sets it to MPI_INFO_NULL. The value of an info argument is
23 interpreted each time the info is passed to a routine. Changes to an info after return from
24 a routine do not affect that interpretation.

1
2
3
4
5
6
7
8
9
10
11
12
13
14
15
16
17
18
19
20
21
22
23
24
25
26
27
28
29
30
31
32
33
34
35
36
37
38
39
40
41
42
43
44
45
46
47
48

Chapter 10

Process Creation and Management

10.1 Introduction

MPI is primarily concerned with communication rather than process or resource management. However, it is necessary to address these issues to some degree in order to define a useful framework for communication. This chapter presents a set of MPI interfaces that allow for a variety of approaches to process management while placing minimal restrictions on the execution environment.

The MPI model for process creation allows both the creation of an initial set of processes related by their membership in a common MPI_COMM_WORLD and the creation and management of processes after an MPI application has been started. A major impetus for the later form of process creation comes from the PVM [24] research effort. This work has provided a wealth of experience with process management and resource control that illustrates their benefits and potential pitfalls.

The MPI Forum decided not to address resource control because it was not able to design a portable interface that would be appropriate for the broad spectrum of existing and potential resource and process controllers. Resource control can encompass a wide range of abilities, including adding and deleting nodes from a virtual parallel machine, reserving and scheduling resources, managing compute partitions of an MPP, and returning information about available resources. assumes that resource control is provided externally — probably by computer vendors, in the case of tightly coupled systems, or by a third party software package when the environment is a cluster of workstations.

The reasons for including process management in MPI are both technical and practical. Important classes of message-passing applications require process control. These include task farms, serial applications with parallel modules, and problems that require a run-time assessment of the number and type of processes that should be started. On the practical side, users of workstation clusters who are migrating from PVM to MPI may be accustomed to using PVM's capabilities for process and resource management. The lack of these features would be a practical stumbling block to migration.

The following goals are central to the design of MPI process management:

- The MPI process model must apply to the vast majority of current parallel environments. These include everything from tightly integrated MPPs to heterogeneous networks of workstations.
- MPI must not take over operating system responsibilities. It should instead provide a

1 clean interface between an application and system software.

- 2
- 3 • MPI must guarantee communication determinism in the presense of dynamic processes,
4 i.e., dynamic process management must not introduce unavoidable race conditions.
- 5
- 6 • MPI must not contain features that compromise performance.

7 The process management model addresses these issues in two ways. First, MPI remains
8 primarily a communication library. It does not manage the parallel environment in which
9 a parallel program executes, though it provides a minimal interface between an application
10 and external resource and process managers.

11 Second, MPI maintains a consistent concept of a communicator, regardless of how its
12 members came into existence. A communicator is never changed once created, and it is
13 always created using deterministic collective operations.

14 10.2 The Dynamic Process Model

15
16
17 The dynamic process model allows for the creation and cooperative termination of processes
18 after an MPI application has started. It provides a mechanism to establish communication
19 between the newly created processes and the existing MPI application. It also provides a
20 mechanism to establish communication between two existing MPI applications, even when
21 one did not “start” the other.

22 10.2.1 Starting Processes

23
24 MPI applications may start new processes through an interface to an external process man-
25 ager.

26
27 MPI_COMM_SPAWN starts MPI processes and establishes communication with them,
28 returning an intercommunicator. MPI_COMM_SPAWN_MULTIPLE starts several different
29 binaries (or the same binary with different arguments), placing them in the same
30 MPI_COMM_WORLD and returning an intercommunicator.

31 MPI uses the existing group abstraction to represent processes. A process is identified
32 by a (group, rank) pair.

33 10.2.2 The Runtime Environment

34
35 The MPI_COMM_SPAWN and MPI_COMM_SPAWN_MULTIPLE routines provide an inter-
36 face between MPI and the *runtime environment* of an MPI application. The difficulty is that
37 there is an enormous range of runtime environments and application requirements, and MPI
38 must not be tailored to any particular one. Examples of such environments are:

- 39
- 40
- 41 • **MPP managed by a batch queueing system.** Batch queueing systems generally
42 allocate resources before an application begins, enforce limits on resource use (CPU
43 time, memory use, etc.), and do not allow a change in resource allocation after a
44 job begins. Moreover, many MPPs have special limitations or extensions, such as a
45 limit on the number of processes that may run on one processor, or the ability to
46 gang-schedule processes of a parallel application.
- 47
- 48

- **Network of workstations with PVM.** PVM (Parallel Virtual Machine) allows a user to create a “virtual machine” out of a network of workstations. An application may extend the virtual machine or manage processes (create, kill, redirect output, etc.) through the PVM library. Requests to manage the machine or processes may be intercepted and handled by an external resource manager.
- **Network of workstations managed by a load balancing system.** A load balancing system may choose the location of spawned processes based on dynamic quantities, such as load average. It may transparently migrate processes from one machine to another when a resource becomes unavailable.
- **Large SMP with Unix.** Applications are run directly by the user. They are scheduled at a low level by the operating system. Processes may have special scheduling characteristics (gang-scheduling, processor affinity, deadline scheduling, processor locking, etc.) and be subject to OS resource limits (number of processes, amount of memory, etc.).

MPI assumes, implicitly, the existence of an environment in which an application runs. It does not provide “operating system” services, such as a general ability to query what processes are running, to kill arbitrary processes, to find out properties of the runtime environment (how many processors, how much memory, etc.).

Complex interaction of an MPI application with its runtime environment should be done through an environment-specific API. An example of such an API would be the PVM task and machine management routines — `pvm_addhosts`, `pvm_config`, `pvm_tasks`, etc., possibly modified to return an MPI (group,rank) when possible. A Condor or PBS API would be another possibility.

At some low level, obviously, MPI must be able to interact with the runtime system, but the interaction is not visible at the application level and the details of the interaction are not specified by the MPI standard.

In many cases, it is impossible to keep environment-specific information out of the MPI interface without seriously compromising MPI functionality. To permit applications to take advantage of environment-specific functionality, many MPI routines take an `info` argument that allows an application to specify environment-specific information. There is a tradeoff between functionality and portability: applications that make use of `info` are not portable.

MPI does not require the existence of an underlying “virtual machine” model, in which there is a consistent global view of an MPI application and an implicit “operating system” managing resources and processes. For instance, processes spawned by one task may not be visible to another; additional hosts added to the runtime environment by one process may not be visible in another process; tasks spawned by different processes may not be automatically distributed over available resources.

Interaction between MPI and the runtime environment is limited to the following areas:

- A process may start new processes with `MPI_COMM_SPAWN` and `MPI_COMM_SPAWN_MULTIPLE`.
- When a process spawns a child process, it may optionally use an `info` argument to tell the runtime environment where or how to start the process. This extra information may be opaque to MPI.

- An attribute `MPI_UNIVERSE_SIZE` on `MPI_COMM_WORLD` tells a program how “large” the initial runtime environment is, namely how many processes can usefully be started in all. One can subtract the size of `MPI_COMM_WORLD` from this value to find out how many processes might usefully be started in addition to those already running.

10.3 Process Manager Interface

10.3.1 Processes in MPI

A process is represented in MPI by a (group, rank) pair. A (group, rank) pair specifies a unique process but a process does not determine a unique (group, rank) pair, since a process may belong to several groups.

10.3.2 Starting Processes and Establishing Communication

The following routine starts a number of MPI processes and establishes communication with them, returning an intercommunicator.

Advice to users. It is possible in MPI to start a static SPMD or MPMD application by starting first one process and having that process start its siblings with `MPI_COMM_SPAWN`. This practice is discouraged primarily for reasons of performance. If possible, it is preferable to start all processes at once, as a single MPI application. (*End of advice to users.*)

```
MPI_COMM_SPAWN(command, argv, maxprocs, info, root, comm, intercomm,
                array_of_errcodes)
```

IN	command	name of program to be spawned (string, significant only at root)
IN	argv	arguments to command (array of strings, significant only at root)
IN	maxprocs	maximum number of processes to start (integer, significant only at root)
IN	info	a set of key-value pairs telling the runtime system where and how to start the processes (handle, significant only at root)
IN	root	rank of process in which previous arguments are examined (integer)
IN	comm	intracommunicator containing group of spawning processes (handle)
OUT	intercomm	intercommunicator between original group and the newly spawned group (handle)
OUT	array_of_errcodes	one code per process (array of integer)

```
int MPI_Comm_spawn(const char *command, char *argv[], int maxprocs,
```

ticket140.

```

MPI_Info info, int root, MPI_Comm comm, MPI_Comm *intercomm,
int array_of_errcodes[])
MPI_Comm_spawn(command, argv, maxprocs, info, root, comm, intercomm,
array_of_errcodes, ierror) BIND(C)
CHARACTER(LEN=*), INTENT(IN) :: command, argv(*)
INTEGER, INTENT(IN) :: maxprocs, root
TYPE(MPI_Info), INTENT(IN) :: info
TYPE(MPI_Comm), INTENT(IN) :: comm
TYPE(MPI_Comm), INTENT(OUT) :: intercomm
INTEGER :: array_of_errcodes(*)
INTEGER, OPTIONAL, INTENT(OUT) :: ierror
MPI_COMM_SPAWN(COMMAND, ARGV, MAXPROCS, INFO, ROOT, COMM, INTERCOMM,
ARRAY_OF_ERRCODES, IERROR)
CHARACTER*(*) COMMAND, ARGV(*)
INTEGER INFO, MAXPROCS, ROOT, COMM, INTERCOMM, ARRAY_OF_ERRCODES(*),
IERROR
{MPI::Intercomm MPI::Intracomm::Spawn(const char* command,
const char* argv[], int maxprocs, const MPI::Info& info,
int root, int array_of_errcodes[]) const(binding deprecated, see
Section 15.2) }
{MPI::Intercomm MPI::Intracomm::Spawn(const char* command,
const char* argv[], int maxprocs, const MPI::Info& info,
int root) const(binding deprecated, see Section 15.2) }

```

MPI_COMM_SPAWN tries to start maxprocs identical copies of the MPI program specified by command, establishing communication with them and returning an intercommunicator. The spawned processes are referred to as children. The children have their own MPI_COMM_WORLD, which is separate from that of the parents. MPI_COMM_SPAWN is collective over comm, and also may not return until MPI_INIT has been called in the children. Similarly, MPI_INIT in the children may not return until all parents have called MPI_COMM_SPAWN. In this sense, MPI_COMM_SPAWN in the parents and MPI_INIT in the children form a collective operation over the union of parent and child processes. The intercommunicator returned by MPI_COMM_SPAWN contains the parent processes in the local group and the child processes in the remote group. The ordering of processes in the local and remote groups is the same as the ordering of the group of the comm in the parents and of MPI_COMM_WORLD of the children, respectively. This intercommunicator can be obtained in the children through the function MPI_COMM_GET_PARENT.

Advice to users. An implementation may automatically establish communication before MPI_INIT is called by the children. Thus, completion of MPI_COMM_SPAWN in the parent does not necessarily mean that MPI_INIT has been called in the children (although the returned intercommunicator can be used immediately). (*End of advice to users.*)

The command argument The command argument is a string containing the name of a program to be spawned. The string is null-terminated in C. In Fortran, leading and trailing

spaces are stripped. MPI does not specify how to find the executable or how the working directory is determined. These rules are implementation-dependent and should be appropriate for the runtime environment.

Advice to implementors. The implementation should use a natural rule for finding executables and determining working directories. For instance, a homogeneous system with a global file system might look first in the working directory of the spawning process, or might search the directories in a PATH environment variable as do Unix shells. An implementation on top of PVM would use PVM's rules for finding executables (usually in \$HOME/pvm3/bin/\$PVM_ARCH). An MPI implementation running under POE on an IBM SP would use POE's method of finding executables. An implementation should document its rules for finding executables and determining working directories, and a high-quality implementation should give the user some control over these rules. (*End of advice to implementors.*)

If the program named in `command` does not call `MPI_INIT`, but instead forks a process that calls `MPI_INIT`, the results are undefined. Implementations may allow this case to work but are not required to.

Advice to users. MPI does not say what happens if the program you start is a shell script and that shell script starts a program that calls `MPI_INIT`. Though some implementations may allow you to do this, they may also have restrictions, such as requiring that arguments supplied to the shell script be supplied to the program, or requiring that certain parts of the environment not be changed. (*End of advice to users.*)

The `argv` argument `argv` is an array of strings containing arguments that are passed to the program. The first element of `argv` is the first argument passed to `command`, not, as is conventional in some contexts, the command itself. The argument list is terminated by `NULL` in C and C++ and an empty string in Fortran. In Fortran, leading and trailing spaces are always stripped, so that a string consisting of all spaces is considered an empty string. The constant `MPI_ARGV_NULL` may be used in C, C++ and Fortran to indicate an empty argument list. In C and C++, this constant is the same as `NULL`.

Example 10.1 Examples of `argv` in C and Fortran

To run the program "ocean" with arguments "-gridfile" and "ocean1.grd" in C:

```
char command[] = "ocean";
char *argv[] = {"-gridfile", "ocean1.grd", NULL};
MPI_Comm_spawn(command, argv, ...);
```

or, if not everything is known at compile time:

```
char *command;
char **argv;
command = "ocean";
argv=(char **)malloc(3 * sizeof(char *));
argv[0] = "-gridfile";
argv[1] = "ocean1.grd";
argv[2] = NULL;
MPI_Comm_spawn(command, argv, ...);
```

In Fortran:

```

CHARACTER*25 command, argv(3)
command = ' ocean '
argv(1) = ' -gridfile '
argv(2) = ' ocean1.grd'
argv(3) = ' '
call MPI_COMM_SPAWN(command, argv, ...)

```

Arguments are supplied to the program if this is allowed by the operating system. In C, the MPI_COMM_SPAWN argument `argv` differs from the `argv` argument of `main` in two respects. First, it is shifted by one element. Specifically, `argv[0]` of `main` is provided by the implementation and conventionally contains the name of the program (given by `command`). `argv[1]` of `main` corresponds to `argv[0]` in MPI_COMM_SPAWN, `argv[2]` of `main` to `argv[1]` of MPI_COMM_SPAWN, etc. Second, `argv` of MPI_COMM_SPAWN must be null-terminated, so that its length can be determined. Passing an `argv` of MPI_ARGV_NULL to MPI_COMM_SPAWN results in `main` receiving `argc` of 1 and an `argv` whose element 0 is (conventionally) the name of the program.

If a Fortran implementation supplies routines that allow a program to obtain its arguments, the arguments may be available through that mechanism. In C, if the operating system does not support arguments appearing in `argv` of `main()`, the MPI implementation may add the arguments to the `argv` that is passed to MPI_INIT.

The `maxprocs` argument MPI tries to spawn `maxprocs` processes. If it is unable to spawn `maxprocs` processes, it raises an error of class MPI_ERR_SPAWN.

An implementation may allow the `info` argument to change the default behavior, such that if the implementation is unable to spawn all `maxprocs` processes, it may spawn a smaller number of processes instead of raising an error. In principle, the `info` argument may specify an arbitrary set $\{m_i : 0 \leq m_i \leq \text{maxprocs}\}$ of allowed values for the number of processes spawned. The set $\{m_i\}$ does not necessarily include the value `maxprocs`. If an implementation is able to spawn one of these allowed numbers of processes, MPI_COMM_SPAWN returns successfully and the number of spawned processes, m , is given by the size of the remote group of `intercomm`. If m is less than `maxproc`, reasons why the other processes were not spawned are given in `array_of_errcodes` as described below. If it is not possible to spawn one of the allowed numbers of processes, MPI_COMM_SPAWN raises an error of class MPI_ERR_SPAWN.

A spawn call with the default behavior is called *hard*. A spawn call for which fewer than `maxprocs` processes may be returned is called *soft*. See Section 10.3.4 on page 402 for more information on the `soft` key for `info`.

Advice to users. By default, requests are hard and MPI errors are fatal. This means that by default there will be a fatal error if MPI cannot spawn all the requested processes. If you want the behavior “spawn as many processes as possible, up to N ,” you should do a soft spawn, where the set of allowed values $\{m_i\}$ is $\{0 \dots N\}$. However, this is not completely portable, as implementations are not required to support soft spawning. (*End of advice to users.*)

The `info` argument The `info` argument to all of the routines in this chapter is an opaque handle of type MPI_Info in C and Fortran with the `mpi_f08` module, MPI::Info in C++ and

INTEGER in Fortran **with the mpi module or the include file mpif.h**. It is a container for a number of user-specified (key,value) pairs. key and value are strings (null-terminated `char*` in C, `character*(*)` in Fortran). Routines to create and manipulate the `info` argument are described in Section 9 on page 385.

For the SPAWN calls, `info` provides additional (and possibly implementation-dependent) instructions to MPI and the runtime system on how to start processes. An application may pass `MPI_INFO_NULL` in C or Fortran. Portable programs not requiring detailed control over process locations should use `MPI_INFO_NULL`.

MPI does not specify the content of the `info` argument, except to reserve a number of special key values (see Section 10.3.4 on page 402). The `info` argument is quite flexible and could even be used, for example, to specify the executable and its command-line arguments. In this case the `command` argument to `MPI_COMM_SPAWN` could be empty. The ability to do this follows from the fact that MPI does not specify how an executable is found, and the `info` argument can tell the runtime system where to “find” the executable “” (empty string). Of course a program that does this will not be portable across MPI implementations.

The root argument All arguments before the root argument are examined only on the process whose rank in `comm` is equal to `root`. The value of these arguments on other processes is ignored.

The array_of_errcodes argument The `array_of_errcodes` is an array of length `maxprocs` in which MPI reports the status of each process that MPI was requested to start. If all `maxprocs` processes were spawned, `array_of_errcodes` is filled in with the value `MPI_SUCCESS`. If only m ($0 \leq m < \text{maxprocs}$) processes are spawned, m of the entries will contain `MPI_SUCCESS` and the rest will contain an implementation-specific error code indicating the reason MPI could not start the process. MPI does not specify which entries correspond to failed processes. An implementation may, for instance, fill in error codes in one-to-one correspondence with a detailed specification in the `info` argument. These error codes all belong to the error class `MPI_ERR_SPAWN` if there was no error in the argument list. In C or Fortran, an application may pass `MPI_ERRCODES_IGNORE` if it is not interested in the error codes. In C++ this constant does not exist, and the `array_of_errcodes` argument may be omitted from the argument list.

Advice to implementors. `MPI_ERRCODES_IGNORE` in Fortran is a special type of constant, like `MPI_BOTTOM`. See the discussion in Section 2.5.4 on page 15. (*End of advice to implementors.*)

`MPI_COMM_GET_PARENT(parent)`

OUT parent the parent communicator (handle)

`int MPI_Comm_get_parent(MPI_Comm *parent)`

`MPI_Comm_get_parent(parent, ierror) BIND(C)`
`TYPE(MPI_Comm), INTENT(OUT) :: parent`
`INTEGER, OPTIONAL, INTENT(OUT) :: ierror`

`MPI_COMM_GET_PARENT(PARENT, IERROR)`

```

INTEGER PARENT, IERROR
{static MPI::Intercomm MPI::Comm::Get_parent() (binding deprecated, see
    Section 15.2) }

```

If a process was started with `MPI_COMM_SPAWN` or `MPI_COMM_SPAWN_MULTIPLE`, `MPI_COMM_GET_PARENT` returns the “parent” intercommunicator of the current process. This parent intercommunicator is created implicitly inside of `MPI_INIT` and is the same intercommunicator returned by `SPAWN` in the parents.

If the process was not spawned, `MPI_COMM_GET_PARENT` returns `MPI_COMM_NULL`.

After the parent communicator is freed or disconnected, `MPI_COMM_GET_PARENT` returns `MPI_COMM_NULL`.

Advice to users. `MPI_COMM_GET_PARENT` returns a handle to a single intercommunicator. Calling `MPI_COMM_GET_PARENT` a second time returns a handle to the same intercommunicator. Freeing the handle with `MPI_COMM_DISCONNECT` or `MPI_COMM_FREE` will cause other references to the intercommunicator to become invalid (dangling). Note that calling `MPI_COMM_FREE` on the parent communicator is not useful. (*End of advice to users.*)

Rationale. The desire of the Forum was to create a constant `MPI_COMM_PARENT` similar to `MPI_COMM_WORLD`. Unfortunately such a constant cannot be used (syntactically) as an argument to `MPI_COMM_DISCONNECT`, which is explicitly allowed. (*End of rationale.*)

10.3.3 Starting Multiple Executables and Establishing Communication

While `MPI_COMM_SPAWN` is sufficient for most cases, it does not allow the spawning of multiple binaries, or of the same binary with multiple sets of arguments. The following routine spawns multiple binaries or the same binary with multiple sets of arguments, establishing communication with them and placing them in the same `MPI_COMM_WORLD`.

```

1 MPI_COMM_SPAWN_MULTIPLE(count, array_of_commands, array_of_argv, array_of_maxprocs,
2   array_of_info, root, comm, intercomm, array_of_errcodes)
3
4   IN      count          number of commands (positive integer, significant to
5   MPI only at root — see advice to users)
6
7   IN      array_of_commands  programs to be executed (array of strings, significant
8   only at root)
9
10  IN      array_of_argv     arguments for commands (array of array of strings,
11  significant only at root)
12
13  IN      array_of_info     info objects telling the runtime system where and how
14  to start processes (array of handles, significant only at
15  root)
16
17  IN      root              rank of process in which previous arguments are ex-
18  amined (integer)
19
20  IN      comm              intracommunicator containing group of spawning pro-
21  cesses (handle)
22
23  OUT     intercomm         intercommunicator between original group and newly
24  spawned group (handle)
25
26  OUT     array_of_errcodes  one error code per process (array of integer)

```

```

25 int MPI_Comm_spawn_multiple(int count, char *array_of_commands[],
26   char **array_of_argv[], const int array_of_maxprocs[], const
27   MPI_Info array_of_info[], int root, MPI_Comm comm,
28   MPI_Comm *intercomm, int array_of_errcodes[])

```

```

29 MPI_Comm_spawn_multiple(count, array_of_commands, array_of_argv,
30   array_of_maxprocs, array_of_info, root, comm, intercomm,
31   array_of_errcodes, ierror) BIND(C)

```

```

32   INTEGER, INTENT(IN) :: count, array_of_maxprocs(*), root
33   CHARACTER(LEN=*), INTENT(IN) :: array_of_commands(*),
34   array_of_argv(count, *)
35   TYPE(MPI_Info), INTENT(IN) :: array_of_info(*)
36   TYPE(MPI_Comm), INTENT(IN) :: comm
37   TYPE(MPI_Comm), INTENT(OUT) :: intercomm
38   INTEGER :: array_of_errcodes(*)
39   INTEGER, OPTIONAL, INTENT(OUT) :: ierror

```

```

40
41 MPI_COMM_SPAWN_MULTIPLE(COUNT, ARRAY_OF_COMMANDS, ARRAY_OF_ARGV,
42   ARRAY_OF_MAXPROCS, ARRAY_OF_INFO, ROOT, COMM, INTERCOMM,
43   ARRAY_OF_ERRCODES, IERROR)
44   INTEGER COUNT, ARRAY_OF_INFO(*), ARRAY_OF_MAXPROCS(*), ROOT, COMM,
45   INTERCOMM, ARRAY_OF_ERRCODES(*), IERROR
46   CHARACTER*(*) ARRAY_OF_COMMANDS(*), ARRAY_OF_ARGV(COUNT, *)

```



```

{MPI::Intercomm MPI::Intracomm::Spawn_multiple(int count,
        const char* array_of_commands[], const char** array_of_argv[],
        const int array_of_maxprocs[],
        const MPI::Info array_of_info[], int root,
        int array_of_errcodes[]) (binding deprecated, see Section 15.2) }
{MPI::Intercomm MPI::Intracomm::Spawn_multiple(int count,
        const char* array_of_commands[], const char** array_of_argv[],
        const int array_of_maxprocs[],
        const MPI::Info array_of_info[], int root) (binding deprecated, see
        Section 15.2) }

```

MPI_COMM_SPAWN_MULTIPLE is identical to MPI_COMM_SPAWN except that there are multiple executable specifications. The first argument, `count`, gives the number of specifications. Each of the next four arguments are simply arrays of the corresponding arguments in MPI_COMM_SPAWN. For the Fortran version of `array_of_argv`, the element `array_of_argv(i,j)` is the `j`-th argument to command number `i`.

Rationale. This may seem backwards to Fortran programmers who are familiar with Fortran's column-major ordering. However, it is necessary to do it this way to allow MPI_COMM_SPAWN to sort out arguments. Note that the leading dimension of `array_of_argv` *must* be the same as `count`. Also note that Fortran rules for sequence association allow a different value in the first dimension; in this case, the sequence of array elements is interpreted by MPI_COMM_SPAWN_MULTIPLE as if the sequence is stored in an array defined with the first dimension set to `count`. This Fortran feature allows an implementor to define MPI_ARGVS_NULL (see below) with fixed dimensions, e.g., (1,1), or only with one dimension, e.g., (1). (*End of rationale.*)

Advice to users. The argument `count` is interpreted by MPI only at the root, as is `array_of_argv`. Since the leading dimension of `array_of_argv` is `count`, a non-positive value of `count` at a non-root node could theoretically cause a runtime bounds check error, even though `array_of_argv` should be ignored by the subroutine. If this happens, you should explicitly supply a reasonable value of `count` on the non-root nodes. (*End of advice to users.*)

In any language, an application may use the constant MPI_ARGVS_NULL (which is likely to be `(char ***)0` in C) to specify that no arguments should be passed to any commands. The effect of setting individual elements of `array_of_argv` to MPI_ARGV_NULL is not defined. To specify arguments for some commands but not others, the commands without arguments should have a corresponding `argv` whose first element is null (`(char *)0` in C and empty string in Fortran). In Fortran at non-root processes, the `count` argument must be set to a value that is consistent with the provided `array_of_argv` although the content of these arguments has no meaning for this operation.

All of the spawned processes have the same MPI_COMM_WORLD. Their ranks in MPI_COMM_WORLD correspond directly to the order in which the commands are specified in MPI_COMM_SPAWN_MULTIPLE. Assume that m_1 processes are generated by the first command, m_2 by the second, etc. The processes corresponding to the first command have ranks $0, 1, \dots, m_1 - 1$. The processes in the second command have ranks $m_1, m_1 + 1, \dots, m_1 + m_2 - 1$. The processes in the third have ranks $m_1 + m_2, m_1 + m_2 + 1, \dots, m_1 + m_2 + m_3 - 1$, etc.

1 *Advice to users.* Calling MPI_COMM_SPAWN multiple times would create many
 2 sets of children with different MPI_COMM_WORLDS whereas
 3 MPI_COMM_SPAWN_MULTIPLE creates children with a single MPI_COMM_WORLD,
 4 so the two methods are not completely equivalent. There are also two performance-
 5 related reasons why, if you need to spawn multiple executables, you may want to
 6 use MPI_COMM_SPAWN_MULTIPLE instead of calling MPI_COMM_SPAWN several
 7 times. First, spawning several things at once may be faster than spawning them
 8 sequentially. Second, in some implementations, communication between processes
 9 spawned at the same time may be faster than communication between processes
 10 spawned separately. (*End of advice to users.*)

11
 12 The `array_of_errcodes` argument is a 1-dimensional array of size $\sum_{i=1}^{count} n_i$, where n_i is
 13 the i -th element of `array_of_maxprocs`. Command number i corresponds to the n_i contiguous
 14 slots in this array from element $\sum_{j=1}^{i-1} n_j$ to $[\sum_{j=1}^i n_j] - 1$. Error codes are treated as for
 15 MPI_COMM_SPAWN.

16 **Example 10.2** Examples of `array_of_argv` in C and Fortran

17 To run the program “ocean” with arguments “-gridfile” and “ocean1.grd” and the program
 18 “atmos” with argument “atmos.grd” in C:

```
19
20     char *array_of_commands[2] = {"ocean", "atmos"};
21     char **array_of_argv[2];
22     char *argv0[] = {"-gridfile", "ocean1.grd", (char *)0};
23     char *argv1[] = {"atmos.grd", (char *)0};
24     array_of_argv[0] = argv0;
25     array_of_argv[1] = argv1;
26     MPI_Comm_spawn_multiple(2, array_of_commands, array_of_argv, ...);
27
```

28 Here’s how you do it in Fortran:

```
29     CHARACTER*25 commands(2), array_of_argv(2, 3)
30     commands(1) = ' ocean '
31     array_of_argv(1, 1) = ' -gridfile '
32     array_of_argv(1, 2) = ' ocean1.grd'
33     array_of_argv(1, 3) = ' '
34
35     commands(2) = ' atmos '
36     array_of_argv(2, 1) = ' atmos.grd '
37     array_of_argv(2, 2) = ' '
38
39     call MPI_COMM_SPAWN_MULTIPLE(2, commands, array_of_argv, ...)
```

41 10.3.4 Reserved Keys

42 The following keys are reserved. An implementation is not required to interpret these keys,
 43 but if it does interpret the key, it must provide the functionality described.

44 **host** Value is a hostname. The format of the hostname is determined by the implementation.

45 **arch** Value is an architecture name. Valid architecture names and what they mean are
 46 determined by the implementation.

`wdir` Value is the name of a directory on a machine on which the spawned process(es) execute(s). This directory is made the working directory of the executing process(es). The format of the directory name is determined by the implementation.

`path` Value is a directory or set of directories where the implementation should look for the executable. The format of `path` is determined by the implementation.

`file` Value is the name of a file in which additional information is specified. The format of the filename and internal format of the file are determined by the implementation.

`soft` Value specifies a set of numbers which are allowed values for the number of processes that `MPI_COMM_SPAWN` (et al.) may create. The format of the value is a comma-separated list of Fortran-90 triplets each of which specifies a set of integers and which together specify the set formed by the union of these sets. Negative values in this set and values greater than `maxprocs` are ignored. MPI will spawn the largest number of processes it can, consistent with some number in the set. The order in which triplets are given is not significant.

By Fortran-90 triplets, we mean:

1. `a` means a
2. `a:b` means $a, a + 1, a + 2, \dots, b$
3. `a:b:c` means $a, a + c, a + 2c, \dots, a + ck$, where for $c > 0$, k is the largest integer for which $a + ck \leq b$ and for $c < 0$, k is the largest integer for which $a + ck \geq b$. If $b > a$ then c must be positive. If $b < a$ then c must be negative.

Examples:

1. `a:b` gives a range between a and b
2. `0:N` gives full “soft” functionality
3. `1,2,4,8,16,32,64,128,256,512,1024,2048,4096` allows power-of-two number of processes.
4. `2:10000:2` allows even number of processes.
5. `2:10:2,7` allows 2, 4, 6, 7, 8, or 10 processes.

10.3.5 Spawn Example

Manager-worker Example [] Using `MPI_COMM_SPAWN`.

```

/* manager */
#include "mpi.h"
int main(int argc, char *argv[])
{
    int world_size, universe_size, *universe_sizep, flag;
    MPI_Comm everyone;          /* intercommunicator */
    char worker_program[100];

    MPI_Init(&argc, &argv);
    MPI_Comm_size(MPI_COMM_WORLD, &world_size);

```

ticket0.

```

1   if (world_size != 1)    error("Top heavy with management");
2
3   MPI_Comm_get_attr(MPI_COMM_WORLD, MPI_UNIVERSE_SIZE,
4                     &universe_sizep, &flag);
5   if (!flag) {
6       printf("This MPI does not support UNIVERSE_SIZE. How many\n\
7 processes total?");
8       scanf("%d", &universe_size);
9   } else universe_size = *universe_sizep;
10  if (universe_size == 1) error("No room to start workers");
11
12  /*
13   * Now spawn the workers. Note that there is a run-time determination
14   * of what type of worker to spawn, and presumably this calculation must
15   * be done at run time and cannot be calculated before starting
16   * the program. If everything is known when the application is
17   * first started, it is generally better to start them all at once
18   * in a single MPI_COMM_WORLD.
19   */
20
21  choose_worker_program(worker_program);
22  MPI_Comm_spawn(worker_program, MPI_ARGV_NULL, universe_size-1,
23                MPI_INFO_NULL, 0, MPI_COMM_SELF, &everyone,
24                MPI_ERRCODES_IGNORE);
25  /*
26   * Parallel code here. The communicator "everyone" can be used
27   * to communicate with the spawned processes, which have ranks 0,..
28   * MPI_UNIVERSE_SIZE-1 in the remote group of the intercommunicator
29   * "everyone".
30   */
31
32  MPI_Finalize();
33  return 0;
34 }
35
36 /* worker */
37
38 #include "mpi.h"
39 int main(int argc, char *argv[])
40 {
41     int size;
42     MPI_Comm parent;
43     MPI_Init(&argc, &argv);
44     MPI_Comm_get_parent(&parent);
45     if (parent == MPI_COMM_NULL) error("No parent!");
46     MPI_Comm_remote_size(parent, &size);
47     if (size != 1) error("Something's wrong with the parent");
48

```

```

/*
 * Parallel code here.
 * The manager is represented as the process with rank 0 in (the remote
 * group of) the parent communicator.  If the workers need to communicate
 * among themselves, they can use MPI_COMM_WORLD.
 */

MPI_Finalize();
return 0;
}

```

10.4 Establishing Communication

This section provides functions that establish communication between two sets of MPI processes that do not share a communicator.

Some situations in which these functions are useful are:

1. Two parts of an application that are started independently need to communicate.
2. A visualization tool wants to attach to a running process.
3. A server wants to accept connections from multiple clients. Both clients and server may be parallel programs.

In each of these situations, MPI must establish communication channels where none existed before, and there is no parent/child relationship. The routines described in this section establish communication between the two sets of processes by creating an MPI intercommunicator, where the two groups of the intercommunicator are the original sets of processes.

Establishing contact between two groups of processes that do not share an existing communicator is a collective but asymmetric process. One group of processes indicates its willingness to accept connections from other groups of processes. We will call this group the (parallel) *server*, even if this is not a client/server type of application. The other group connects to the server; we will call it the *client*.

Advice to users. While the names *client* and *server* are used throughout this section, MPI does not guarantee the traditional robustness of client server systems. The functionality described in this section is intended to allow two cooperating parts of the same application to communicate with one another. For instance, a client that gets a segmentation fault and dies, or one that doesn't participate in a collective operation may cause a server to crash or hang. (*End of advice to users.*)

10.4.1 Names, Addresses, Ports, and All That

Almost all of the complexity in MPI client/server routines addresses the question “how does the client find out how to contact the server?” The difficulty, of course, is that there is no existing communication channel between them, yet they must somehow agree on a rendezvous point where they will establish communication.

1 Agreeing on a rendezvous point always involves a third party. The third party may
2 itself provide the rendezvous point or may communicate rendezvous information from server
3 to client. Complicating matters might be the fact that a client doesn't really care what
4 server it contacts, only that it be able to get in touch with one that can handle its request.

5 Ideally, MPI can accommodate a wide variety of run-time systems while retaining the
6 ability to write simple portable code. The following should be compatible with MPI:

- 7
- 8 • The server resides at a well-known internet address host:port.
- 9
- 10 • The server prints out an address to the terminal, the user gives this address to the
11 client program.
- 12
- 13 • The server places the address information on a nameserver, where it can be retrieved
14 with an agreed-upon name.
- 15
- 16 • The server to which the client connects is actually a broker, acting as a middleman
17 between the client and the real server.

18 MPI does not require a nameserver, so not all implementations will be able to support
19 all of the above scenarios. However, MPI provides an optional nameserver interface, and is
20 compatible with external name servers.

21 A `port_name` is a *system-supplied* string that encodes a low-level network address at
22 which a server can be contacted. Typically this is an IP address and a port number, but
23 an implementation is free to use any protocol. The server establishes a `port_name` with
24 the `MPI_OPEN_PORT` routine. It accepts a connection to a given port with
25 `MPI_COMM_ACCEPT`. A client uses `port_name` to connect to the server.

26 By itself, the `port_name` mechanism is completely portable, but it may be clumsy
27 to use because of the necessity to communicate `port_name` to the client. It would be more
28 convenient if a server could specify that it be known by an *application-supplied* `service_name`
29 so that the client could connect to that `service_name` without knowing the `port_name`.

30 An MPI implementation may allow the server to publish a (`port_name`, `service_name`)
31 pair with `MPI_PUBLISH_NAME` and the client to retrieve the port name from the service
32 name with `MPI_LOOKUP_NAME`. This allows three levels of portability, with increasing
33 levels of functionality.

- 34 1. Applications that do not rely on the ability to publish names are the most portable.
35 Typically the `port_name` must be transferred “by hand” from server to client.
- 36
- 37 2. Applications that use the `MPI_PUBLISH_NAME` mechanism are completely portable
38 among implementations that provide this service. To be portable among all imple-
39 mentations, these applications should have a fall-back mechanism that can be used
40 when names are not published.
- 41
- 42 3. Applications may ignore MPI's name publishing functionality and use their own mech-
43 anism (possibly system-supplied) to publish names. This allows arbitrary flexibility
44 but is not portable.

10.4.2 Server Routines

A server makes itself available with two routines. First it must call `MPI_OPEN_PORT` to establish a port at which it may be contacted. Secondly it must call `MPI_COMM_ACCEPT` to accept connections from clients.

`MPI_OPEN_PORT`(info, port_name)

IN	info	implementation-specific information on how to establish an address (handle)
OUT	port_name	newly established port (string)

`int MPI_Open_port(MPI_Info info, char *port_name)`

```
MPI_Open_port(info, port_name, ierror) BIND(C)
    TYPE(MPI_Info), INTENT(IN) :: info
    CHARACTER(LEN=MPI_MAX_PORT_NAME), INTENT(OUT) :: port_name
    INTEGER, OPTIONAL, INTENT(OUT) :: ierror
```

```
MPI_OPEN_PORT(INFO, PORT_NAME, IERROR)
    CHARACTER*(*) PORT_NAME
    INTEGER INFO, IERROR
```

```
{void MPI::Open_port(const MPI::Info& info, char* port_name) (binding
    deprecated, see Section 15.2) }
```

This function establishes a network address, encoded in the `port_name` string, at which the server will be able to accept connections from clients. `port_name` is supplied by the system, possibly using information in the `info` argument.

`MPI` copies a system-supplied port name into `port_name`. `port_name` identifies the newly opened port and can be used by a client to contact the server. The maximum size string that may be supplied by the system is `MPI_MAX_PORT_NAME`.

Advice to users. The system copies the port name into `port_name`. The application must pass a buffer of sufficient size to hold this value. (*End of advice to users.*)

`port_name` is essentially a network address. It is unique within the communication universe to which it belongs (determined by the implementation), and may be used by any client within that communication universe. For instance, if it is an internet (host:port) address, it will be unique on the internet. If it is a low level switch address on an IBM SP, it will be unique to that SP.

Advice to implementors. These examples are not meant to constrain implementations. A `port_name` could, for instance, contain a user name or the name of a batch job, as long as it is unique within some well-defined communication domain. The larger the communication domain, the more useful `MPI`'s client/server functionality will be. (*End of advice to implementors.*)

The precise form of the address is implementation-defined. For instance, an internet address may be a host name or IP address, or anything that the implementation can decode into an IP address. A port name may be reused after it is freed with `MPI_CLOSE_PORT` and released by the system.

1 *Advice to implementors.* Since the user may type in `port_name` by hand, it is useful
 2 to choose a form that is easily readable and does not have embedded spaces. (*End of*
 3 *advice to implementors.*)

5 `info` may be used to tell the implementation how to establish the address. It may, and
 6 usually will, be `MPI_INFO_NULL` in order to get the implementation defaults.

8
 9 `MPI_CLOSE_PORT(port_name)`

10 IN `port_name` a port (string)

11
 12 `int MPI_Close_port(const char *port_name)`

13 `MPI_Close_port(port_name, ierror) BIND(C)`
 14 `CHARACTER(LEN=*), INTENT(IN) :: port_name`
 15 `INTEGER, OPTIONAL, INTENT(OUT) :: ierror`

16
 17 `MPI_CLOSE_PORT(PORT_NAME, IERROR)`

18 `CHARACTER*(*) PORT_NAME`
 19 `INTEGER IERROR`

20
 21 `{void MPI::Close_port(const char* port_name) (binding deprecated, see Section 15.2)`
 22 `}`

23 This function releases the network address represented by `port_name`.

24
 25
 26 `MPI_COMM_ACCEPT(port_name, info, root, comm, newcomm)`

27 IN `port_name` port name (string, used only on root)

28 IN `info` implementation-dependent information (handle, used
 29 only on root)

30
 31 IN `root` rank in `comm` of root node (integer)

32 IN `comm` intracommunicator over which call is collective (han-
 33 dle)

34
 35 OUT `newcomm` intercommunicator with client as remote group (han-
 36 dle)

37
 38 `int MPI_Comm_accept(const char *port_name, MPI_Info info, int root,`
 39 `MPI_Comm comm, MPI_Comm *newcomm)`

40 `MPI_Comm_accept(port_name, info, root, comm, newcomm, ierror) BIND(C)`
 41 `CHARACTER(LEN=*), INTENT(IN) :: port_name`
 42 `TYPE(MPI_Info), INTENT(IN) :: info`
 43 `INTEGER, INTENT(IN) :: root`
 44 `TYPE(MPI_Comm), INTENT(IN) :: comm`
 45 `TYPE(MPI_Comm), INTENT(OUT) :: newcomm`
 46 `INTEGER, OPTIONAL, INTENT(OUT) :: ierror`

47
 48 `MPI_COMM_ACCEPT(PORT_NAME, INFO, ROOT, COMM, NEWCOMM, IERROR)`

```

CHARACTER*(*) PORT_NAME
INTEGER INFO, ROOT, COMM, NEWCOMM, IERROR
{MPI::Intercomm MPI::Intracomm::Accept(const char* port_name,
    const MPI::Info& info, int root) const(binding deprecated, see
    Section 15.2) }

```

MPI_COMM_ACCEPT establishes communication with a client. It is collective over the calling communicator. It returns an intercommunicator that allows communication with the client.

The `port_name` must have been established through a call to `MPI_OPEN_PORT`.

`info` is a implementation-defined string that may allow fine control over the `ACCEPT` call.

10.4.3 Client Routines

There is only one routine on the client side.

MPI_COMM_CONNECT(`port_name`, `info`, `root`, `comm`, `newcomm`)

IN	<code>port_name</code>	network address (string, used only on root)
IN	<code>info</code>	implementation-dependent information (handle, used only on root)
IN	<code>root</code>	rank in <code>comm</code> of root node (integer)
IN	<code>comm</code>	intracommunicator over which call is collective (handle)
OUT	<code>newcomm</code>	intercommunicator with server as remote group (handle)

```

int MPI_Comm_connect(const char *port_name, MPI_Info info, int root,
    MPI_Comm comm, MPI_Comm *newcomm)

```

```

MPI_Comm_connect(port_name, info, root, comm, newcomm, ierror) BIND(C)
    CHARACTER(LEN=*), INTENT(IN) :: port_name
    TYPE(MPI_Info), INTENT(IN) :: info
    INTEGER, INTENT(IN) :: root
    TYPE(MPI_Comm), INTENT(IN) :: comm
    TYPE(MPI_Comm), INTENT(OUT) :: newcomm
    INTEGER, OPTIONAL, INTENT(OUT) :: ierror

```

MPI_COMM_CONNECT(PORT_NAME, INFO, ROOT, COMM, NEWCOMM, IERROR)

```

CHARACTER*(*) PORT_NAME
INTEGER INFO, ROOT, COMM, NEWCOMM, IERROR

```

```

{MPI::Intercomm MPI::Intracomm::Connect(const char* port_name,
    const MPI::Info& info, int root) const(binding deprecated, see
    Section 15.2) }

```

This routine establishes communication with a server specified by `port_name`. It is collective over the calling communicator and returns an intercommunicator in which the remote group participated in an `MPI_COMM_ACCEPT`.

If the named port does not exist (or has been closed), `MPI_COMM_CONNECT` raises an error of class `MPI_ERR_PORT`.

If the port exists, but does not have a pending `MPI_COMM_ACCEPT`, the connection attempt will eventually time out after an implementation-defined time, or succeed when the server calls `MPI_COMM_ACCEPT`. In the case of a time out, `MPI_COMM_CONNECT` raises an error of class `MPI_ERR_PORT`.

Advice to implementors. The time out period may be arbitrarily short or long. However, a high quality implementation will try to queue connection attempts so that a server can handle simultaneous requests from several clients. A high quality implementation may also provide a mechanism, through the `info` arguments to `MPI_OPEN_PORT`, `MPI_COMM_ACCEPT` and/or `MPI_COMM_CONNECT`, for the user to control timeout and queuing behavior. (*End of advice to implementors.*)

MPI provides no guarantee of fairness in servicing connection attempts. That is, connection attempts are not necessarily satisfied in the order they were initiated and competition from other connection attempts may prevent a particular connection attempt from being satisfied.

`port_name` is the address of the server. It must be the same as the name returned by `MPI_OPEN_PORT` on the server. Some freedom is allowed here. If there are equivalent forms of `port_name`, an implementation may accept them as well. For instance, if `port_name` is (hostname:port), an implementation may accept (ip_address:port) as well.

10.4.4 Name Publishing

The routines in this section provide a mechanism for publishing names. A (`service_name`, `port_name`) pair is published by the server, and may be retrieved by a client using the `service_name` only. An MPI implementation defines the *scope* of the `service_name`, that is, the domain over which the `service_name` can be retrieved. If the domain is the empty set, that is, if no client can retrieve the information, then we say that name publishing is not supported. Implementations should document how the scope is determined. High-quality implementations will give some control to users through the `info` arguments to name publishing functions. Examples are given in the descriptions of individual functions.

```
MPI_PUBLISH_NAME(service_name, info, port_name)
```

IN	<code>service_name</code>	a service name to associate with the port (string)
IN	<code>info</code>	implementation-specific information (handle)
IN	<code>port_name</code>	a port name (string)

```
int MPI_Publish_name(const char *service_name, MPI_Info info, const
                    char *port_name)
```

```
MPI_Publish_name(service_name, info, port_name, ierror) BIND(C)
                TYPE(MPI_Info), INTENT(IN) :: info
```

ticket140.
ticket140.
ticket-248T.

```

CHARACTER(LEN=*), INTENT(IN) :: service_name, port_name
INTEGER, OPTIONAL, INTENT(OUT) :: ierror
MPI_PUBLISH_NAME(SERVICE_NAME, INFO, PORT_NAME, IERROR)
  INTEGER INFO, IERROR
  CHARACTER*(*) SERVICE_NAME, PORT_NAME
{void MPI::Publish_name(const char* service_name, const MPI::Info& info,
  const char* port_name) (binding deprecated, see Section 15.2) }
```

This routine publishes the pair (port_name, service_name) so that an application may retrieve a system-supplied port_name using a well-known service_name.

The implementation must define the *scope* of a published service name, that is, the domain over which the service name is unique, and conversely, the domain over which the (port name, service name) pair may be retrieved. For instance, a service name may be unique to a job (where job is defined by a distributed operating system or batch scheduler), unique to a machine, or unique to a Kerberos realm. The scope may depend on the info argument to MPI_PUBLISH_NAME.

MPI permits publishing more than one service_name for a single port_name. On the other hand, if service_name has already been published within the scope determined by info, the behavior of MPI_PUBLISH_NAME is undefined. An MPI implementation may, through a mechanism in the info argument to MPI_PUBLISH_NAME, provide a way to allow multiple servers with the same service in the same scope. In this case, an implementation-defined policy will determine which of several port names is returned by MPI_LOOKUP_NAME.

Note that while service_name has a limited scope, determined by the implementation, port_name always has global scope within the communication universe used by the implementation (i.e., it is globally unique).

port_name should be the name of a port established by MPI_OPEN_PORT and not yet deleted by MPI_CLOSE_PORT. If it is not, the result is undefined.

Advice to implementors. In some cases, an MPI implementation may use a name service that a user can also access directly. In this case, a name published by MPI could easily conflict with a name published by a user. In order to avoid such conflicts, MPI implementations should mangle service names so that they are unlikely to conflict with user code that makes use of the same service. Such name mangling will of course be completely transparent to the user.

The following situation is problematic but unavoidable, if we want to allow implementations to use nameservers. Suppose there are multiple instances of “ocean” running on a machine. If the scope of a service name is confined to a job, then multiple oceans can coexist. If an implementation provides site-wide scope, however, multiple instances are not possible as all calls to MPI_PUBLISH_NAME after the first may fail. There is no universal solution to this.

To handle these situations, a high-quality implementation should make it possible to limit the domain over which names are published. (*End of advice to implementors.*)

```

1 MPI_UNPUBLISH_NAME(service_name, info, port_name)
2     IN      service_name      a service name (string)
3
4     IN      info              implementation-specific information (handle)
5
6     IN      port_name         a port name (string)

```

```

7 int MPI_Unpublish_name(const char *service_name, MPI_Info info, const
8                       char *port_name)

```

```

9 MPI_Unpublish_name(service_name, info, port_name, ierror) BIND(C)
10 CHARACTER(LEN=*), INTENT(IN) :: service_name, port_name
11 TYPE(MPI_Info), INTENT(IN) :: info
12 INTEGER, OPTIONAL, INTENT(OUT) :: ierror

```

```

14 MPI_UNPUBLISH_NAME(SERVICE_NAME, INFO, PORT_NAME, IERROR)
15     INTEGER INFO, IERROR
16     CHARACTER*(*) SERVICE_NAME, PORT_NAME

```

```

18 {void MPI::Unpublish_name(const char* service_name, const MPI::Info& info,
19                          const char* port_name) (binding deprecated, see Section 15.2) }

```

This routine unpublishes a service name that has been previously published. Attempting to unpublish a name that has not been published or has already been unpublished is erroneous and is indicated by the error class MPI_ERR_SERVICE.

All published names must be unpublished before the corresponding port is closed and before the publishing process exits. The behavior of MPI_UNPUBLISH_NAME is implementation dependent when a process tries to unpublish a name that it did not publish.

If the info argument was used with MPI_PUBLISH_NAME to tell the implementation how to publish names, the implementation may require that info passed to MPI_UNPUBLISH_NAME contain information to tell the implementation how to unpublish a name.

```

32 MPI_LOOKUP_NAME(service_name, info, port_name)
33     IN      service_name      a service name (string)
34
35     IN      info              implementation-specific information (handle)
36
37     OUT     port_name         a port name (string)

```

```

38 int MPI_Lookup_name(const char *service_name, MPI_Info info,
39                   char *port_name)

```

```

41 MPI_Lookup_name(service_name, info, port_name, ierror) BIND(C)
42 CHARACTER(LEN=*), INTENT(IN) :: service_name
43 TYPE(MPI_Info), INTENT(IN) :: info
44 CHARACTER(LEN=MPI_MAX_PORT_NAME), INTENT(OUT) :: port_name
45 INTEGER, OPTIONAL, INTENT(OUT) :: ierror

```

```

46 MPI_LOOKUP_NAME(SERVICE_NAME, INFO, PORT_NAME, IERROR)
47     CHARACTER*(*) SERVICE_NAME, PORT_NAME

```

INTEGER INFO, IERROR

```
{void MPI::Lookup_name(const char* service_name, const MPI::Info& info,
                       char* port_name) (binding deprecated, see Section 15.2) }
```

This function retrieves a `port_name` published by `MPI_PUBLISH_NAME` with `service_name`. If `service_name` has not been published, it raises an error in the error class `MPI_ERR_NAME`. The application must supply a `port_name` buffer large enough to hold the largest possible port name (see discussion above under `MPI_OPEN_PORT`).

If an implementation allows multiple entries with the same `service_name` within the same scope, a particular `port_name` is chosen in a way determined by the implementation.

If the `info` argument was used with `MPI_PUBLISH_NAME` to tell the implementation how to publish names, a similar `info` argument may be required for `MPI_LOOKUP_NAME`.

10.4.5 Reserved Key Values

The following key values are reserved. An implementation is not required to interpret these key values, but if it does interpret the key value, it must provide the functionality described.

`ip_port` Value contains IP port number at which to establish a port. (Reserved for `MPI_OPEN_PORT` only).

`ip_address` Value contains IP address at which to establish a port. If the address is not a valid IP address of the host on which the `MPI_OPEN_PORT` call is made, the results are undefined. (Reserved for `MPI_OPEN_PORT` only).

10.4.6 Client/Server Examples

Simplest Example — Completely Portable.

The following example shows the simplest way to use the client/server interface. It does not use service names at all.

On the server side:

```
char myport[MPI_MAX_PORT_NAME];
MPI_Comm intercomm;
/* ... */
MPI_Open_port(MPI_INFO_NULL, myport);
printf("port name is: %s\n", myport);

MPI_Comm_accept(myport, MPI_INFO_NULL, 0, MPI_COMM_SELF, &intercomm);
/* do something with intercomm */
```

The server prints out the port name to the terminal and the user must type it in when starting up the client (assuming the MPI implementation supports stdin such that this works). On the client side:

```
MPI_Comm intercomm;
char name[MPI_MAX_PORT_NAME];
printf("enter port name: ");
gets(name);
MPI_Comm_connect(name, MPI_INFO_NULL, 0, MPI_COMM_SELF, &intercomm);
```

1 Ocean/Atmosphere - Relies on Name Publishing

2 In this example, the “ocean” application is the “server” side of a coupled ocean-atmosphere
3 climate model. It assumes that the MPI implementation publishes names.
4

```
5
6     MPI_Open_port(MPI_INFO_NULL, port_name);
7     MPI_Publish_name("ocean", MPI_INFO_NULL, port_name);
8
9     MPI_Comm_accept(port_name, MPI_INFO_NULL, 0, MPI_COMM_SELF, &intercomm);
10    /* do something with intercomm */
11    MPI_Unpublish_name("ocean", MPI_INFO_NULL, port_name);
12
```

13
14 On the client side:

```
15
16     MPI_Lookup_name("ocean", MPI_INFO_NULL, port_name);
17     MPI_Comm_connect( port_name, MPI_INFO_NULL, 0, MPI_COMM_SELF,
18                     &intercomm);
19
```

20 Simple Client-Server Example.

21 This is a simple example; the server accepts only a single connection at a time and serves
22 that connection until the client requests to be disconnected. The server is a single process.
23

24 Here is the server. It accepts a single connection and then processes data until it
25 receives a message with tag 1. A message with tag 0 tells the server to exit.

```
26 #include "mpi.h"
27 int main( int argc, char **argv )
28 {
29     MPI_Comm client;
30     MPI_Status status;
31     char port_name[MPI_MAX_PORT_NAME];
32     double buf[MAX_DATA];
33     int size, again;
34
35     MPI_Init( &argc, &argv );
36     MPI_Comm_size(MPI_COMM_WORLD, &size);
37     if (size != 1) error(FATAL, "Server too big");
38     MPI_Open_port(MPI_INFO_NULL, port_name);
39     printf("server available at %s\n",port_name);
40     while (1) {
41         MPI_Comm_accept( port_name, MPI_INFO_NULL, 0, MPI_COMM_WORLD,
42                         &client );
43         again = 1;
44         while (again) {
45             MPI_Recv( buf, MAX_DATA, MPI_DOUBLE,
46                     MPI_ANY_SOURCE, MPI_ANY_TAG, client, &status );
47             switch (status.MPI_TAG) {
48                 case 0: MPI_Comm_free( &client );
```

```

        MPI_Close_port(port_name);          1
        MPI_Finalize();                    2
        return 0;                          3
    case 1: MPI_Comm_disconnect( &client ); 4
        again = 0;                         5
        break;                             6
    case 2: /* do something */             7
    ...                                     8
    default:                               9
        /* Unexpected message type */    10
        MPI_Abort( MPI_COMM_WORLD, 1 );   11
    }                                     12
}                                       13
}                                       14
}                                       15
}                                       16

```

Here is the client.

```

#include "mpi.h"                            17
int main( int argc, char **argv )          18
{                                           19
    MPI_Comm server;                       20
    double buf[MAX_DATA];                 21
    char port_name[MPI_MAX_PORT_NAME];     22

    MPI_Init( &argc, &argv );            23
    strcpy(port_name, argv[1] ); /* assume server's name is cmd-line arg */ 24

    MPI_Comm_connect( port_name, MPI_INFO_NULL, 0, MPI_COMM_WORLD, 25
                      &server );         26

    while (!done) {                        27
        tag = 2; /* Action to perform */  28
        MPI_Send( buf, n, MPI_DOUBLE, 0, tag, server ); 29
        /* etc */                          30
    }                                       31

    MPI_Send( buf, 0, MPI_DOUBLE, 0, 1, server ); 32
    MPI_Comm_disconnect( &server );       33
    MPI_Finalize();                       34
    return 0;                             35
}                                           36

```

10.5 Other Functionality

10.5.1 Universe Size

Many “dynamic” MPI applications are expected to exist in a static runtime environment, in which resources have been allocated before the application is run. When a user (or

possibly a batch system) runs one of these quasi-static applications, she will usually specify a number of processes to start and a total number of processes that are expected. An application simply needs to know how many slots there are, i.e., how many processes it should spawn.

MPI provides an attribute on `MPI_COMM_WORLD`, `MPI_UNIVERSE_SIZE`, that allows the application to obtain this information in a portable manner. This attribute indicates the total number of processes that are expected. In Fortran, the attribute is the integer value. In C, the attribute is a pointer to the integer value. An application typically subtracts the size of `MPI_COMM_WORLD` from `MPI_UNIVERSE_SIZE` to find out how many processes it should spawn. `MPI_UNIVERSE_SIZE` is initialized in `MPI_INIT` and is not changed by MPI. If defined, it has the same value on all processes of `MPI_COMM_WORLD`. `MPI_UNIVERSE_SIZE` is determined by the application startup mechanism in a way not specified by MPI. (The size of `MPI_COMM_WORLD` is another example of such a parameter.)

Possibilities for how `MPI_UNIVERSE_SIZE` might be set include

- A `-universe_size` argument to a program that starts MPI processes.
- Automatic interaction with a batch scheduler to figure out how many processors have been allocated to an application.
- An environment variable set by the user.
- Extra information passed to `MPI_COMM_SPAWN` through the `info` argument.

An implementation must document how `MPI_UNIVERSE_SIZE` is set. An implementation may not support the ability to set `MPI_UNIVERSE_SIZE`, in which case the attribute `MPI_UNIVERSE_SIZE` is not set.

`MPI_UNIVERSE_SIZE` is a recommendation, not necessarily a hard limit. For instance, some implementations may allow an application to spawn 50 processes per processor, if they are requested. However, it is likely that the user only wants to spawn one process per processor.

`MPI_UNIVERSE_SIZE` is assumed to have been specified when an application was started, and is in essence a portable mechanism to allow the user to pass to the application (through the MPI process startup mechanism, such as `mpirexec`) a piece of critical runtime information. Note that no interaction with the runtime environment is required. If the runtime environment changes size while an application is running, `MPI_UNIVERSE_SIZE` is not updated, and the application must find out about the change through direct communication with the runtime system.

10.5.2 Singleton `MPI_INIT`

A high-quality implementation will allow any process (including those not started with a “parallel application” mechanism) to become an MPI process by calling `MPI_INIT`. Such a process can then connect to other MPI processes using the `MPI_COMM_ACCEPT` and `MPI_COMM_CONNECT` routines, or spawn other MPI processes. MPI does not mandate this behavior, but strongly encourages it where technically feasible.

Advice to implementors. To start MPI processes belonging to the same `MPI_COMM_WORLD` requires some special coordination. The processes must be started at the “same” time, they must have a mechanism to establish communication, etc.

Either the user or the operating system must take special steps beyond simply starting processes.

When an application enters `MPI_INIT`, clearly it must be able to determine if these special steps were taken. If a process enters `MPI_INIT` and determines that no special steps were taken (i.e., it has not been given the information to form an `MPI_COMM_WORLD` with other processes) it succeeds and forms a singleton MPI program, that is, one in which `MPI_COMM_WORLD` has size 1.

In some implementations, MPI may not be able to function without an “MPI environment.” For example, MPI may require that daemons be running or MPI may not be able to work at all on the front-end of an MPP. In this case, an MPI implementation may either

1. Create the environment (e.g., start a daemon) or
2. Raise an error if it cannot create the environment and the environment has not been started independently.

A high-quality implementation will try to create a singleton MPI process and not raise an error.

(End of advice to implementors.)

10.5.3 `MPI_APPNUM`

There is a predefined attribute `MPI_APPNUM` of `MPI_COMM_WORLD`. In Fortran, the attribute is an integer value. In C, the attribute is a pointer to an integer value. If a process was spawned with `MPI_COMM_SPAWN_MULTIPLE`, `MPI_APPNUM` is the command number that generated the current process. Numbering starts from zero. If a process was spawned with `MPI_COMM_SPAWN`, it will have `MPI_APPNUM` equal to zero.

Additionally, if the process was not started by a spawn call, but by an implementation-specific startup mechanism that can handle multiple process specifications, `MPI_APPNUM` should be set to the number of the corresponding process specification. In particular, if it is started with

```
mpirexec spec0 [: spec1 : spec2 : ...]
```

`MPI_APPNUM` should be set to the number of the corresponding specification.

If an application was not spawned with `MPI_COMM_SPAWN` or `MPI_COMM_SPAWN_MULTIPLE`, and `MPI_APPNUM` doesn’t make sense in the context of the implementation-specific startup mechanism, `MPI_APPNUM` is not set.

MPI implementations may optionally provide a mechanism to override the value of `MPI_APPNUM` through the info argument. MPI reserves the following key for all `SPAWN` calls.

`appnum` Value contains an integer that overrides the default value for `MPI_APPNUM` in the child.

Rationale. When a single application is started, it is able to figure out how many processes there are by looking at the size of `MPI_COMM_WORLD`. An application consisting of multiple SPMD sub-applications has no way to find out how many sub-applications there are and to which sub-application the process belongs. While there are ways to

figure it out in special cases, there is no general mechanism. MPI_APPNUM provides such a general mechanism. (*End of rationale.*)

10.5.4 Releasing Connections

Before a client and server connect, they are independent MPI applications. An error in one does not affect the other. After establishing a connection with MPI_COMM_CONNECT and MPI_COMM_ACCEPT, an error in one may affect the other. It is desirable for a client and server to be able to disconnect, so that an error in one will not affect the other. Similarly, it might be desirable for a parent and child to disconnect, so that errors in the child do not affect the parent, or vice-versa.

- Two processes are **connected** if there is a communication path (direct or indirect) between them. More precisely:
 1. Two processes are connected if
 - (a) they both belong to the same communicator (inter- or intra-, including MPI_COMM_WORLD) *or*
 - (b) they have previously belonged to a communicator that was freed with MPI_COMM_FREE instead of MPI_COMM_DISCONNECT *or*
 - (c) they both belong to the group of the same window or filehandle.
 2. If A is connected to B and B to C, then A is connected to C.
- Two processes are **disconnected** (also **independent**) if they are not connected.
- By the above definitions, connectivity is a transitive property, and divides the universe of MPI processes into disconnected (independent) sets (equivalence classes) of processes.
- Processes which are connected, but don't share the same MPI_COMM_WORLD may become disconnected (independent) if the communication path between them is broken by using MPI_COMM_DISCONNECT.

The following additional rules apply to MPI routines in other chapters:

- MPI_FINALIZE is collective over a set of connected processes.
- MPI_ABORT does not abort independent processes. It may abort all processes in the caller's MPI_COMM_WORLD (ignoring its `comm` argument). Additionally, it may abort connected processes as well, though it makes a "best attempt" to abort only the processes in `comm`.
- If a process terminates without calling MPI_FINALIZE, independent processes are not affected but the effect on connected processes is not defined.

```
MPI_COMM_DISCONNECT(comm)
```

```
INOUT   comm           communicator (handle)
```

```
int MPI_Comm_disconnect(MPI_Comm *comm)
```

ticket-248T.

```

MPI_Comm_disconnect(comm, ierror) BIND(C)
    TYPE(MPI_Comm), INTENT(INOUT) :: comm
    INTEGER, OPTIONAL, INTENT(OUT) :: ierror

```

```

MPI_COMM_DISCONNECT(COMM, IERROR)
    INTEGER COMM, IERROR

```

```

{void MPI::Comm::Disconnect() (binding deprecated, see Section 15.2) }

```

This function waits for all pending communication on `comm` to complete internally, deallocates the communicator object, and sets the handle to `MPI_COMM_NULL`. It is a collective operation.

It may not be called with the communicator `MPI_COMM_WORLD` or `MPI_COMM_SELF`.

`MPI_COMM_DISCONNECT` may be called only if all communication is complete and matched, so that buffered data can be delivered to its destination. This requirement is the same as for `MPI_FINALIZE`.

`MPI_COMM_DISCONNECT` has the same action as `MPI_COMM_FREE`, except that it waits for pending communication to finish internally and enables the guarantee about the behavior of disconnected processes.

Advice to users. To disconnect two processes you may need to call `MPI_COMM_DISCONNECT`, `MPI_WIN_FREE` and `MPI_FILE_CLOSE` to remove all communication paths between the two processes. Notes that it may be necessary to disconnect several communicators (or to free several windows or files) before two processes are completely independent. (*End of advice to users.*)

Rationale. It would be nice to be able to use `MPI_COMM_FREE` instead, but that function explicitly does not wait for pending communication to complete. (*End of rationale.*)

10.5.5 Another Way to Establish MPI Communication

```

MPI_COMM_JOIN(fd, intercomm)

```

IN	fd	socket file descriptor
OUT	intercomm	new intercommunicator (handle)

```

int MPI_Comm_join(int fd, MPI_Comm *intercomm)

```

```

MPI_Comm_join(fd, intercomm, ierror) BIND(C)
    INTEGER, INTENT(IN) :: fd
    TYPE(MPI_Comm), INTENT(OUT) :: intercomm
    INTEGER, OPTIONAL, INTENT(OUT) :: ierror

```

```

MPI_COMM_JOIN(FD, INTERCOMM, IERROR)
    INTEGER FD, INTERCOMM, IERROR

```

```

{static MPI::Intercomm MPI::Comm::Join(const int fd) (binding deprecated, see
    Section 15.2) }

```

1
2
3
4
5
6
7
8
9
10
11
12
13
14
15
16
17
18
19
20
21
22
23
24
25
26
27
28
29
30
31
32
33
34
35
36
37
38
39
40
41
42
43
44
45
46
47
48

ticket-248T.

1 MPI_COMM_JOIN is intended for MPI implementations that exist in an environment
2 supporting the Berkeley Socket interface [45, 49]. Implementations that exist in an environ-
3 ment not supporting Berkeley Sockets should provide the entry point for MPI_COMM_JOIN
4 and should return MPI_COMM_NULL.

5 This call creates an intercommunicator from the union of two MPI processes which are
6 connected by a socket. MPI_COMM_JOIN should normally succeed if the local and remote
7 processes have access to the same implementation-defined MPI communication universe.
8

9 *Advice to users.* An MPI implementation may require a specific communication
10 medium for MPI communication, such as a shared memory segment or a special switch.
11 In this case, it may not be possible for two processes to successfully join even if there
12 is a socket connecting them and they are using the same MPI implementation. (*End*
13 *of advice to users.*)

14
15 *Advice to implementors.* A high-quality implementation will attempt to establish
16 communication over a slow medium if its preferred one is not available. If implemen-
17 tations do not do this, they must document why they cannot do MPI communication
18 over the medium used by the socket (especially if the socket is a TCP connection).
19 (*End of advice to implementors.*)

20
21 `fd` is a file descriptor representing a socket of type `SOCK_STREAM` (a two-way reliable
22 byte-stream connection). Nonblocking I/O and asynchronous notification via `SIGIO` must
23 not be enabled for the socket. The socket must be in a connected state. The socket must
24 be quiescent when `MPI_COMM_JOIN` is called (see below). It is the responsibility of the
25 application to create the socket using standard socket API calls.

26 `MPI_COMM_JOIN` must be called by the process at each end of the socket. It does not
27 return until both processes have called `MPI_COMM_JOIN`. The two processes are referred
28 to as the local and remote processes.

29 MPI uses the socket to bootstrap creation of the intercommunicator, and for nothing
30 else. Upon return from `MPI_COMM_JOIN`, the file descriptor will be open and quiescent
31 (see below).

32 If MPI is unable to create an intercommunicator, but is able to leave the socket in its
33 original state, with no pending communication, it succeeds and sets `intercomm` to
34 `MPI_COMM_NULL`.

35 The socket must be quiescent before `MPI_COMM_JOIN` is called and after
36 `MPI_COMM_JOIN` returns. More specifically, on entry to `MPI_COMM_JOIN`, a `read` on the
37 socket will not read any data that was written to the socket before the remote process called
38 `MPI_COMM_JOIN`. On exit from `MPI_COMM_JOIN`, a `read` will not read any data that was
39 written to the socket before the remote process returned from `MPI_COMM_JOIN`. It is the
40 responsibility of the application to ensure the first condition, and the responsibility of the
41 MPI implementation to ensure the second. In a multithreaded application, the application
42 must ensure that one thread does not access the socket while another is calling
43 `MPI_COMM_JOIN`, or call `MPI_COMM_JOIN` concurrently.

44
45 *Advice to implementors.* MPI is free to use any available communication path(s)
46 for MPI messages in the new communicator; the socket is only used for the initial
47 handshaking. (*End of advice to implementors.*)
48

MPI_COMM_JOIN uses non-MPI communication to do its work. The interaction of non-MPI communication with pending MPI communication is not defined. Therefore, the result of calling MPI_COMM_JOIN on two connected processes (see Section 10.5.4 on page 418 for the definition of connected) is undefined.

The returned communicator may be used to establish MPI communication with additional processes, through the usual MPI communicator creation mechanisms.

1
2
3
4
5
6
7
8
9
10
11
12
13
14
15
16
17
18
19
20
21
22
23
24
25
26
27
28
29
30
31
32
33
34
35
36
37
38
39
40
41
42
43
44
45
46
47
48

1
2
3
4
5
6
7
8
9
10
11
12
13
14
15
16
17
18
19
20
21
22
23
24
25
26
27
28
29
30
31
32
33
34
35
36
37
38
39
40
41
42
43
44
45
46
47
48

Chapter 11

One-Sided Communications

11.1 Introduction

Remote Memory Access (RMA) extends the communication mechanisms of MPI by allowing one process to specify all communication parameters, both for the sending side and for the receiving side. This mode of communication facilitates the coding of some applications with dynamically changing data access patterns where the data distribution is fixed or slowly changing. In such a case, each process can compute what data it needs to access or to update at other processes. [However, processes may not know which data in their own memory need to be accessed or to be updated by remote processes, and may not even know the identity of these processes.] However, the programmer may not be able to easily determine which data in a process may need to be accessed or to be updated by operations executed by a different process, and may not even know which processes may perform such updates. Thus, the transfer parameters are all available only on one side. Regular send/receive communication requires matching operations by sender and receiver. In order to issue the matching operations, an application needs to distribute the transfer parameters. This distribution may require all processes to participate in a time-consuming global computation, or to [periodically poll for potential communication requests to receive and act upon]poll for potential communication requests to receive and upon which to act periodically. The use of RMA communication mechanisms avoids the need for global computations or explicit polling. A generic example of this nature is the execution of an assignment of the form $A = B(\text{map})$, where `map` is a permutation vector, and `A`, `B` and `map` are distributed in the same manner.

Message-passing communication achieves two effects: *communication* of data from sender to receiver; and *synchronization* of sender with receiver. The RMA design separates these two functions. [Three communication calls are provided: `MPI_PUT` (remote write), `MPI_GET` (remote read) and `MPI_ACCUMULATE` (remote update). A larger number of synchronization calls are provided that support different synchronization styles. The design is similar to that of weakly coherent memory systems: correct ordering of memory accesses has to be imposed by the user, using synchronization calls; the implementation can delay communication operations until the synchronization calls occur, for efficiency.] The following communication calls are provided:

- Remote write: `MPI_PUT`, `MPI_RPUT`
- Remote read: `MPI_GET`, `MPI_RGET`

- 1 • Remote update: MPI_ACCUMULATE, MPI_RACCUMULATE
- 2
- 3 • Remote read and update: MPI_GET_ACCUMULATE, MPI_RGET_ACCUMULATE,
- 4 and MPI_FETCH_AND_OP
- 5
- 6 • Remote atomic swap operations: MPI_COMPARE_AND_SWAP

7 This chapter refers to an operations set that includes all remote update, remote read and
 ticket270. 8 update, and remote atomic swap operations as “accumulate” operations.

9 MPI supports two fundamentally different memory models: separate and unified. The
 10 first model makes no assumption about memory consistency and is highly portable. This
 11 model is similar to that of weakly coherent memory systems: the user must impose correct
 ticket270. 12 ordering of memory accesses through synchronization calls[; for efficiency, the implementa-
 13 tion can delay communication operations until the synchronization calls occur]. The second
 14 model can exploit cache-coherent hardware and hardware-accelerated one-sided operations
 ticket270. 15 that are commonly available in high-performance systems. [In this model, communication
 16 can be independent of synchronization calls.] The two different models are discussed in
 17 detail in Section 11.4. Both models support a large number of synchronization calls to
 18 support different synchronization styles.

19 The design of the RMA functions allows implementors to take advantage [, in many
 ticket270. 20 cases,] of fast or asynchronous communication mechanisms provided by various platforms,
 21 such as coherent or noncoherent shared memory, DMA engines, hardware-supported put/get
 ticket270. 22 operations, and communication coprocessors[, etc]. The most frequently used RMA com-
 ticket0. 23 munication mechanisms can be layered on top of message-passing. [However, support for
 ticket0. 24 asynchronous communication agents in software (handlers, threads, etc.) is needed, for cer-
 ticket270. 25 tain RMA functions, in a distributed memory environment.] However, certain RMA functions
 26 might need support for asynchronous communication agents in software (handlers, threads,
 27 etc.) in a distributed memory environment.

28 We shall denote by **origin** the process that performs the call, and by **target** the
 29 process in which the memory is accessed. Thus, in a put operation, source=origin and
 30 destination=target; in a get operation, source=target and destination=origin.

32 11.2 Initialization

33 [The initialization operation]MPI provides [three]the following window initialization func-
 ticket270. 34 tions, MPI_WIN_CREATE, MPI_WIN_ALLOCATE, MPI_WIN_ALLOCATE_SHARED and
 ticket284. 35 MPI_WIN_CREATE_DYNAMIC that are collective on an intracommunicator.

36 MPI_WIN_CREATE allows each process [in an intracommunicator group] to specify [, in
 ticket270. 37 a collective operation,] a “window” in its memory that is made accessible to accesses by
 ticket270. 38 remote processes. The call returns an opaque object that represents the group of processes
 39 that own and access the set of windows, and the attributes of each window, as specified
 40 by the initialization call. MPI_WIN_ALLOCATE differs from MPI_WIN_CREATE in that
 ticket270. 41 the user does not pass allocated memory; MPI_WIN_ALLOCATE returns a pointer to mem-
 42 mory allocated by the MPI implementation. MPI_WIN_ALLOCATE_SHARED differs from
 ticket284. 43 MPI_WIN_ALLOCATE in that the allocated memory can be accessed from all processes in
 44 the window’s group with direct load/store instructions. Some restrictions apply to the spec-
 45 ified communicator. MPI_WIN_CREATE_DYNAMIC creates a window that allows the user
 46 to dynamically control which memory is exposed by the window.
 47
 48

11.2.1 Window Creation

```
MPI_WIN_CREATE(base, size, disp_unit, info, comm, win)
```

IN	base	initial address of window (choice)	1
IN	size	size of window in bytes (non-negative integer)	2
IN	disp_unit	local unit size for displacements, in bytes (positive integer)	3
IN	info	info argument (handle)	4
IN	comm	intra-communicator (handle)	5
OUT	win	window object returned by the call (handle)	6

```
int MPI_Win_create(void *base, MPI_Aint size, int disp_unit, MPI_Info info,
                  MPI_Comm comm, MPI_Win *win)
```

```
MPI_Win_create(base, size, disp_unit, info, comm, win, ierror) BIND(C)
    TYPE(*), DIMENSION(..), ASYNCHRONOUS :: base
    INTEGER(KIND=MPI_ADDRESS_KIND), INTENT(IN) :: size
    INTEGER, INTENT(IN) :: disp_unit
    TYPE(MPI_Info), INTENT(IN) :: info
    TYPE(MPI_Comm), INTENT(IN) :: comm
    TYPE(MPI_Win), INTENT(OUT) :: win
    INTEGER, OPTIONAL, INTENT(OUT) :: ierror
```

```
MPI_WIN_CREATE(BASE, SIZE, DISP_UNIT, INFO, COMM, WIN, IERROR)
    <type> BASE(*)
    INTEGER(KIND=MPI_ADDRESS_KIND) SIZE
    INTEGER DISP_UNIT, INFO, COMM, WIN, IERROR
```

```
{static MPI::Win MPI::Win::Create(const void* base, MPI::Aint size, int
    disp_unit, const MPI::Info& info, const MPI::Intracomm&
    comm) (binding deprecated, see Section 15.2) }
```

This is a collective call executed by all processes in the group of `comm`. It returns a window object that can be used by these processes to perform RMA operations. Each process specifies a window of existing memory that it exposes to RMA accesses by the processes in the group of `comm`. The window consists of `size` bytes, starting at address `base`. In C and C++, `base` is the starting address of a memory region. In Fortran, one can pass the first element of a memory region or a whole array, which must be ‘simply contiguous’ (for ‘simply contiguous’, see also Section 16.2.12 on page 675). A process may elect to expose no memory by specifying `size = 0`.

The displacement unit argument is provided to facilitate address arithmetic in RMA operations: the target displacement argument of an RMA operation is scaled by the factor `disp_unit` specified by the target process, at window creation.

Rationale. The window size is specified using an address sized integer, so as to allow windows that span more than 4 GB of address space. (Even if the physical memory

size is less than 4 GB, the address range may be larger than 4 GB, if addresses are not contiguous.) (*End of rationale.*)

Advice to users. Common choices for `disp_unit` are 1 (no scaling), and (in C syntax) `sizeof(type)`, for a window that consists of an array of elements of type `type`. The later choice will allow one to use array indices in RMA calls, and have those scaled correctly to byte displacements, even in a heterogeneous environment. (*End of advice to users.*)

The `info` argument provides optimization hints to the runtime about the expected usage pattern of the window. The following info key[is]s are predefined:

`no_locks` — if set to `true`, then the implementation may assume that the local window is never locked (by a call to `MPI_WIN_LOCK` or `MPI_WIN_LOCK_ALL`). This implies that this window is not used for 3-party communication, and RMA can be implemented with no (less) asynchronous agent activity at this process.

`accumulate_ordering` — controls the ordering of accumulate operations at the target. See Section 11.7.2 for details.

`accumulate_ops` — if set to `same_op`, the implementation will assume that all concurrent accumulate calls to the same target address will use the same operation. If set to `same_op_no_op`, then the implementation will assume that all concurrent accumulate calls to the same target address will use the same operation or `MPI_NO_OP`. This can eliminate the need to protect access for certain operation types where the hardware can guarantee atomicity. The default is `same_op_no_op`.

Advice to users. If windows are passed to libraries, the user needs to ensure that the info keys specified at window creation are communicated to the called library, which might need to constrain the operations on the passed window. (*End of advice to users.*)

The various processes in the group of `comm` may specify completely different target windows, in location, size, displacement units and info arguments. As long as all the get, put and accumulate accesses to a particular process fit their specific target window this should pose no problem. The same area in memory may appear in multiple windows, each associated with a different window object. However, concurrent communications to distinct, overlapping windows may lead to [erroneous]undefined results.

Rationale. The reason for specifying the memory that may be accessed from another process in an RMA operation is to permit the programmer to specify what memory can be a target of RMA operations and for the implementation to enforce that specification. For example, with this definition, a server process can safely allow a client process to use RMA operations, knowing that (under the assumption that the MPI implementation does enforce the specified limits on the exposed memory) an error in the client cannot affect any memory other than what was explicitly exposed. (*End of rationale.*)

Advice to users. A window can be created in any part of the process memory. However, on some systems, the performance of windows in memory allocated by MPI_ALLOC_MEM (Section 8.2, page 355) will be better. Also, on some systems, performance is improved when window boundaries are aligned at “natural” boundaries (word, double-word, cache line, page frame, etc.). (*End of advice to users.*)

Advice to implementors. In cases where RMA operations use different mechanisms in different memory areas (e.g., load/store in a shared memory segment, and an asynchronous handler in private memory), the MPI_WIN_CREATE call needs to figure out which type of memory is used for the window. To do so, MPI maintains, internally, the list of memory segments allocated by MPI_ALLOC_MEM, or by other, implementation specific, mechanisms, together with information on the type of memory segment allocated. When a call to MPI_WIN_CREATE occurs, then MPI checks which segment contains each window, and decides, accordingly, which mechanism to use for RMA operations.

Vendors may provide additional, implementation-specific mechanisms to allocate or to specify memory regions that are preferable for use in one-sided communication. In particular, such mechanisms can be used to place static variables into such preferred regions.

Implementors should document any performance impact of window alignment. (*End of advice to implementors.*)

ticket270.

11.2.2 Window That Allocates Memory

MPI_WIN_ALLOCATE(size, disp_unit, info, comm, baseptr, win)

IN	size	size of window in bytes (non-negative integer)
IN	disp_unit	local unit size for displacements, in bytes (positive integer)
IN	info	info argument (handle)
IN	comm	intra-communicator (handle)
OUT	baseptr	initial address of window (choice)
OUT	win	window object returned by the call (handle)

```
int MPI_Win_allocate(MPI_Aint size, int disp_unit, MPI_Info info,
                    MPI_Comm comm, void *baseptr, MPI_Win *win)
```

```
MPI_Win_allocate(size, disp_unit, info, comm, baseptr, win, ierror) BIND(C)
  USE, INTRINSIC :: ISO_C_BINDING, ONLY : C_PTR
  INTEGER(KIND=MPI_ADDRESS_KIND), INTENT(IN) :: size
  INTEGER, INTENT(IN) :: disp_unit
  TYPE(MPI_Info), INTENT(IN) :: info
  TYPE(MPI_Comm), INTENT(IN) :: comm
  TYPE(C_PTR), INTENT(OUT) :: baseptr
```

ticket-248T.

```

1      TYPE(MPI_Win), INTENT(OUT) :: win
2      INTEGER, OPTIONAL, INTENT(OUT) :: ierror
3
4      MPI_WIN_ALLOCATE(SIZE, DISP_UNIT, INFO, COMM, BASEPTR, WIN, IERROR)
5      INTEGER DISP_UNIT, INFO, COMM, WIN, IERROR
6      INTEGER(KIND=MPI_ADDRESS_KIND) SIZE, BASEPTR

```

This is a collective call executed by all processes in the group of `comm`. On each process, it allocates memory of at least `size` bytes, returns a pointer to it, and returns a window object that can be used by all processes in `comm` to perform RMA operations. The returned memory consists of `size` bytes local to each process, starting at address `baseptr` and is associated with the window as if the user called `MPI_WIN_CREATE` on existing memory. The size argument may be different at each process and `size = 0` is valid; however, a library might allocate and expose more memory in order to create a fast, globally symmetric allocation. The discussion of and rationales for `MPI_ALLOC_MEM` and `MPI_FREE_MEM` in Section 8.2 also apply to `MPI_WIN_ALLOCATE`; in particular, see the rationale in Section 8.2 for an explanation of the type used for `baseptr`.

If the Fortran compiler provides `TYPE(C_PTR)`, then the following interface must be provided in the `mpi` module and should be provided in `mpif.h` through overloading, i.e., with the same routine name as the routine with `INTEGER(KIND=MPI_ADDRESS_KIND) BASEPTR`, but with a different linker name:

```

22      INTERFACE MPI_WIN_ALLOCATE
23          SUBROUTINE MPI_WIN_ALLOCATE_CPTR(SIZE, DISP_UNIT, INFO, COMM, BASEPTR, &
24              WIN, IERROR)
25              USE, INTRINSIC :: ISO_C_BINDING, ONLY : C_PTR
26              INTEGER :: DISP_UNIT, INFO, COMM, WIN, IERROR
27              INTEGER(KIND=MPI_ADDRESS_KIND) :: SIZE
28              TYPE(C_PTR) :: BASEPTR
29          END SUBROUTINE
30      END INTERFACE

```

The linker name base of this overloaded function is `MPI_WIN_ALLOCATE_CPTR`. The implied linker names are described in Section 16.2.5 on page 653.

Rationale. By allocating (potentially aligned) memory instead of allowing the user to pass in an arbitrary buffer, this call can improve the performance for systems with remote direct memory access significantly. This also permits the collective allocation of memory and supports what is sometimes called the “symmetric allocation” model that can be more scalable (for example, the implementation can arrange to return an address for the allocated memory that is the same on all processes). (*End of rationale.*)

The `info` argument can be used to specify hints similar to the `info` argument for `MPI_WIN_CREATE` and `MPI_ALLOC_MEM`. The following `info` key is predefined:

`same_size` — if set to true, then the implementation may assume that the argument `size` is identical on all processes.

11.2.3 Window That Allocates Shared Memory

```
MPI_WIN_ALLOCATE_SHARED(size, info, comm, baseptr, win)
```

IN	size	size of local window in bytes (non-negative integer)
IN	info	info argument (handle)
IN	comm	intra-communicator (handle)
OUT	baseptr	address of local allocated window segment (choice)
OUT	win	window object returned by the call (handle)

```
int MPI_Win_allocate_shared(MPI_Aint size, MPI_Info info, MPI_Comm comm,
    void *baseptr, MPI_Win *win)
```

```
MPI_Win_allocate_shared(size, info, comm, baseptr, win, ierror) BIND(C)
    USE, INTRINSIC :: ISO_C_BINDING, ONLY : C_PTR
    INTEGER(KIND=MPI_Address_kind), INTENT(IN) :: size
    TYPE(MPI_Info), INTENT(IN) :: info
    TYPE(MPI_Comm), INTENT(IN) :: comm
    TYPE(C_PTR), INTENT(OUT) :: baseptr
    TYPE(MPI_Win), INTENT(OUT) :: win
    INTEGER, OPTIONAL, INTENT(OUT) :: ierror
```

```
MPI_WIN_ALLOCATE_SHARED(SIZE, INFO, COMM, BASEPTR, WIN, IERROR)
    INTEGER INFO, COMM, WIN, IERROR
    INTEGER(KIND=MPI_ADDRESS_KIND) SIZE, BASEPTR
```

This is a collective call executed by all processes in the group of `comm`. On each process i , it allocates memory of at least `size` bytes that is shared among all processes in `comm`, and returns a pointer to the locally allocated segment in `baseptr` that can be used for load/store accesses on the calling process. The locally allocated memory can be the target of load/store accesses by remote processes; the base pointers for other processes can be queried using the function `MPI_WIN_SHARED_QUERY`. The call also returns a window object that can be used by all processes in `comm` to perform RMA operations. The size argument may be different at each process and `size = 0` is valid; however, a library might allocate and expose more memory in order to create a fast, globally symmetric allocation. It is the user's responsibility to ensure that the communicator `comm` represents a group of processes that can create a shared memory segment that can be accessed by all processes in the group. The discussions of rationales for `MPI_ALLOC_MEM` and `MPI_FREE_MEM` in Section 8.2 also apply to `MPI_WIN_ALLOCATE_SHARED`; in particular, see the rationale in Section 8.2 for an explanation of the type used for `baseptr`. The allocated memory is contiguous across process ranks unless the info key `alloc_shared_noncontig` is specified. Contiguous across process ranks means that the first address in the memory segment of process i is consecutive with the last address in the memory segment of process $i - 1$. This may enable the user to calculate remote address offsets with local information only.

If the Fortran compiler provides `TYPE(C_PTR)`, then the following interface must be provided in the `mpi` module and should be provided in `mpif.h` through overloading, i.e., with

1 the same routine name as the routine with `INTEGER(KIND=MPI_ADDRESS_KIND) BASEPTR`,
 2 but with a different linker name:

```

3
4 INTERFACE MPI_WIN_ALLOCATE_SHARED
5     SUBROUTINE MPI_WIN_ALLOCATE_SHARED_CPTR(SIZE, INFO, COMM, BASEPTR, &
6         WIN, IERROR)
7         USE, INTRINSIC :: ISO_C_BINDING, ONLY : C_PTR
8         INTEGER :: INFO, COMM, WIN, IERROR
9         INTEGER(KIND=MPI_ADDRESS_KIND) :: SIZE
10        TYPE(C_PTR) :: BASEPTR
11    END SUBROUTINE
12 END INTERFACE
  
```

13 The linker name base of this overloaded function is `MPI_WIN_ALLOCATE_SHARED_CPTR`.
 14 The implied linker names are described in Section 16.2.5 on page 653.

15 The `info` argument can be used to specify hints similar to the `info` argument for
 16 `MPI_WIN_CREATE`, `MPI_WIN_ALLOC`, and `MPI_ALLOC_MEM`. The additional `info` key
 17 `alloc_shared_noncontig` allows the library to optimize the layout of the shared memory seg-
 18 ments in memory.

19
 20 *Advice to users.* If the `info` key `alloc_shared_noncontig` is not set to true, the allocation
 21 strategy is to allocate contiguous memory across process ranks. This may limit the
 22 performance on some architectures because it does not allow the implementation to
 23 modify the data layout (e.g., padding to reduce access latency). (*End of advice to*
 24 *users.*)

25
 26 *Advice to implementors.* If the user sets the `info` key `alloc_shared_noncontig` to true,
 27 the implementation can allocate the memory requested by each process in a location
 28 that is close to this process. This can be achieved by padding or allocating memory
 29 in special memory segments. Both techniques may make the address space across
 30 consecutive ranks noncontiguous. (*End of advice to implementors.*)

31 The consistency of load/store accesses from/to the shared memory as observed by the
 32 user program depends on the architecture. A consistent view can be created in the unified
 33 memory model (see Section 11.4) by utilizing the window synchronization functions (see
 34 Section 11.5) or explicitly completing outstanding store accesses (e.g., by calling
 35 `MPI_WIN_FLUSH`). MPI does not define semantics for accessing shared memory windows
 36 in the separate memory model.

37
 38
 39 `MPI_WIN_SHARED_QUERY(win, rank, size, baseptr)`

40	IN	win	shared memory window object (handle)
41	IN	rank	rank in the group of window win (non-negative integer)
42			ger)
43			
44	OUT	size	size of the window segment (non-negative integer)
45	OUT	baseptr	address for load/store access to window segment (choice)
46			

```

47 int MPI_Win_shared_query(MPI_Win win, int rank, MPI_Aint *size,
48     void *baseptr)
  
```

ticket-248T.

```

MPI_Win_shared_query(win, rank, size, baseptr, ierror) BIND(C)
  USE, INTRINSIC :: ISO_C_BINDING, ONLY : C_PTR
  TYPE(MPI_Win), INTENT(IN) :: win
  INTEGER, INTENT(IN) :: rank
  INTEGER(KIND=MPI_Address_kind), INTENT(IN) :: size
  TYPE(C_PTR), INTENT(OUT) :: baseptr
  INTEGER, OPTIONAL, INTENT(OUT) :: ierror

MPI_WIN_SHARED_QUERY(WIN, RANK, SIZE, BASEPTR, IERROR)
  INTEGER WIN, RANK, IERROR
  INTEGER (KIND=MPI_ADDRESS_KIND) SIZE, BASEPTR

```

This function queries the process-local address for remote memory segments created with `MPI_WIN_ALLOCATE_SHARED`. This function can return different process-local addresses for the same physical memory on different processes. The returned memory can be used for load/store accesses subject to the constraints defined in Section 11.7. This function can only be called with windows of type `MPI_WIN_FLAVOR_SHARED`. If the passed window is not of flavor `MPI_WIN_FLAVOR_SHARED`, the error `MPI_ERR_RMA_WRONG_FLAVOR` is raised. When rank is `MPI_PROC_NULL`, the pointer and size returned are the pointer and size of the memory segment belonging the lowest rank that specified `size > 0`. If all processes in the group attached to the window specified `size = 0`, then the call returns `size = 0` and a `baseptr` as if `MPI_ALLOC_MEM` was called with `size = 0`.

If the Fortran compiler provides `TYPE(C_PTR)`, then the following interface must be provided in the `mpi` module and should be provided in `mpif.h` through overloading, i.e., with the same routine name as the routine with `INTEGER(KIND=MPI_ADDRESS_KIND) BASEPTR`, but with a different linker name:

```

INTERFACE MPI_WIN_SHARED_QUERY
  SUBROUTINE MPI_WIN_SHARED_QUERY_CPTR(WIN, RANK, SIZE, BASEPTR, IERROR)
    USE, INTRINSIC :: ISO_C_BINDING, ONLY : C_PTR
    INTEGER :: WIN, RANK, IERROR
    INTEGER(KIND=MPI_ADDRESS_KIND) :: SIZE
    TYPE(C_PTR) :: BASEPTR
  END SUBROUTINE
END INTERFACE

```

The linker name base of this overloaded function is `MPI_WIN_SHARED_QUERY_CPTR`. The implied linker names are described in Section 16.2.5 on page 653.

11.2.4 Window of Dynamically Attached Memory

The MPI-2 RMA model requires the user to identify the local memory that may be a target of RMA calls at the time the window is created. This has advantages for both the programmer (only this memory can be updated by one-sided operations and provides greater safety) and the MPI implementation (special steps may be taken to make one-sided access to such memory more efficient). However, consider implementing a modifiable linked list using RMA operations; as new items are added to the list, memory must be allocated. In a C or C++ program, this memory is typically allocated using `malloc` or `new` respectively. In MPI-2 RMA, the programmer must create a window with a predefined amount of memory and

then implement routines for allocating memory from within that memory. In addition, there is no easy way to handle the situation where the predefined amount of memory turns out to be inadequate. To support this model, the routine `MPI_WIN_CREATE_DYNAMIC` creates a window that makes it possible to expose memory without remote synchronization. It must be used in combination with the local routines `MPI_WIN_ATTACH` and `MPI_WIN_DETACH`.

```
MPI_WIN_CREATE_DYNAMIC(info, comm, win)
```

IN	info	info argument (handle)
IN	comm	intra-communicator (handle)
OUT	win	window object returned by the call (handle)

```
int MPI_Win_create_dynamic(MPI_Info info, MPI_Comm comm, MPI_Win *win)
```

```
MPI_Win_create_dynamic(info, comm, win, ierror) BIND(C)
```

```
TYPE(MPI_Info), INTENT(IN) :: info
TYPE(MPI_Comm), INTENT(IN) :: comm
TYPE(MPI_Win), INTENT(OUT) :: win
INTEGER, OPTIONAL, INTENT(OUT) :: ierror
```

```
MPI_WIN_CREATE_DYNAMIC(INFO, COMM, WIN, IERROR)
```

```
INTEGER INFO, COMM, WIN, IERROR
```

This is a collective call executed by all processes in the group of `comm`. It returns a window `win` without memory attached. Existing process memory can be attached as described below. This routine returns a window object that can be used by these processes to perform RMA operations on attached memory. Because this window has special properties, it will sometimes be referred to as a *dynamic* window.

The `info` argument can be used to specify hints similar to the `info` argument for `MPI_WIN_CREATE`.

In the case of a window created with `MPI_WIN_CREATE_DYNAMIC`, the `target_disp` for all RMA functions is the address at the target; i.e., the effective `window_base` is `MPI_BOTTOM` and the `disp_unit` is one. Users should use `MPI_GET_ADDRESS` at the target process to determine the address of a target memory location and communicate this address to the origin process.

Advice to implementors. In environments with heterogeneous data representations, care must be exercised in communicating addresses between processes. For example, it is possible that an address valid at the target process (for example, a 64-bit pointer) cannot be expressed as an address at the origin (for example, the origin uses 32-bit pointers). For this reason, a portable MPI implementation should ensure that the type `MPI_AINT` (cf. Table 3.3 on Page 31) is able to store addresses from any process. (*End of advice to implementors.*)

Memory in this window may not be used as the target of one-sided accesses in this window until it is attached using the function `MPI_WIN_ATTACH`. That is, in addition to using `MPI_WIN_CREATE_DYNAMIC` to create an MPI window, the user must use `MPI_WIN_ATTACH` before any local memory may be the target of an MPI RMA operation. Only memory that is currently accessible may be attached.

MPI_WIN_ATTACH(win, base, size)

IN	win	window object (handle)
IN	base	initial address of memory to be attached
IN	size	size of memory to be attached in bytes

```
int MPI_Win_attach(MPI_Win win, void *base, MPI_Aint size)
```

```
MPI_Win_attach(win, base, size, ierror) BIND(C)
```

```
  TYPE(MPI_Win), INTENT(IN) :: win
  TYPE(*), ASYNCHRONOUS :: base
  INTEGER(KIND=MPI_ADDRESS_KIND), INTENT(IN) :: size
  INTEGER, OPTIONAL, INTENT(OUT) :: ierror
```

```
MPI_WIN_ATTACH(WIN, BASE, SIZE, IERROR)
```

```
  INTEGER WIN, IERROR
  <type> [base]BASE(*)
  INTEGER (KIND=MPI_ADDRESS_[SIZE]KIND) [size]SIZE
```

Attaches a local memory region beginning at `base` for remote access within the given window. The memory region specified must not contain any part that is already attached to the window `win`, that is, attaching overlapping memory concurrently within the same window is erroneous. The argument `win` must be a window that was created with `MPI_WIN_CREATE_DYNAMIC`. Multiple (but non-overlapping) memory regions may be attached to the same window.

Rationale. Requiring that memory be explicitly attached before it is exposed to one-sided access by other processes can significantly simplify implementations and improve performance. The ability to make memory available for RMA operations without requiring a collective `MPI_WIN_CREATE` call is needed for some one-sided programming models. (*End of rationale.*)

Advice to users. [Memory registration]Attaching memory to a window may require the use of scarce resources; thus, attaching large regions of memory is not recommended in portable programs. [Memory registration]Attaching memory to a window may fail if sufficient resources are not available; this is similar to the behavior of `MPI_ALLOC_MEM`.

The user is also responsible for ensuring that [memory registration]`MPI_WIN_ATTACH` at the target has [completed]returned before a process attempts to target that memory with an MPI RMA call.

Performing an RMA operation to memory that has not been attached [from]to a window created with `MPI_WIN_CREATE_DYNAMIC` is erroneous. (*End of advice to users.*)

Advice to implementors. A high-quality implementation will attempt to make as much memory available for [registration]attaching as possible. Any limitations should be documented by the implementor. (*End of advice to implementors.*)

[Memory registration] Attaching memory is a local operation as defined by MPI, which means that the call is not collective and completes without requiring any MPI routine to be called in any other process. Memory may be detached with the routine `MPI_WIN_DETACH`. After memory has been detached, it may not be the target of an MPI RMA operation on that window (unless the memory is re-attached with `MPI_WIN_ATTACH`).

`MPI_WIN_DETACH(win, base)`

IN	win	window object (handle)
IN	base	initial address of memory to be detached

`int MPI_Win_detach(MPI_Win win, const void *base)`

`MPI_Win_detach(win, base, ierror) BIND(C)`
`TYPE(MPI_Win), INTENT(IN) :: win`
`TYPE(*), ASYNCHRONOUS :: base`
`INTEGER, OPTIONAL, INTENT(OUT) :: ierror`

`MPI_WIN_DETACH(WIN, BASE, IERROR)`

`INTEGER WIN, IERROR`
`<type> [base]BASE(*)`

Detaches a previously attached memory region beginning at `base`. The arguments `base` and `win` must match the arguments passed to a previous call to `MPI_WIN_ATTACH`.

Advice to users. Detaching memory may permit the implementation to make more efficient use of special memory or provide memory that may be needed by a subsequent `MPI_WIN_ATTACH`. Users are encouraged to detach memory that is no longer needed. Memory should be detached before it is freed by the user. (*End of advice to users.*)

Memory becomes detached when the associated dynamic memory window is freed, see Section 11.2.5.

11.2.5 Window Destruction

`MPI_WIN_FREE(win)`

INOUT	win	window object (handle)
-------	-----	------------------------

`int MPI_Win_free(MPI_Win *win)`

`MPI_Win_free(win, ierror) BIND(C)`
`TYPE(MPI_Win), INTENT(INOUT) :: win`
`INTEGER, OPTIONAL, INTENT(OUT) :: ierror`

`MPI_WIN_FREE(WIN, IERROR)`

`INTEGER WIN, IERROR`

`{void MPI::Win::Free() (binding deprecated, see Section 15.2) }`

Frees the window object `win` and returns a null handle (equal to `MPI_WIN_NULL`). This is a collective call executed by all processes in the group associated with `win`. `MPI_WIN_FREE(win)` can be invoked by a process only after it has completed its involvement in RMA communications on window `win`: [i.e.]e.g., the process has called `MPI_WIN_FENCE`, or called `MPI_WIN_WAIT` to match a previous call to `MPI_WIN_POST` or called `MPI_WIN_COMPLETE` to match a previous call to `MPI_WIN_START` or called `MPI_WIN_UNLOCK` to match a previous call to `MPI_WIN_LOCK`. [When the call returns, the window memory can be freed.]The memory associated with windows created by a call to `MPI_WIN_CREATE` may be freed after the call returns. If the window was created with `MPI_WIN_ALLOCATE`, `MPI_WIN_FREE` will free the window memory that was allocated in `MPI_WIN_ALLOCATE`. Freeing a window that was created with a call to `MPI_WIN_CREATE_DYNAMIC` detaches all associated memory; i.e., it has the same effect as if all attached memory was detached by a call to `MPI_WIN_DETACH`.

Advice to implementors. `MPI_WIN_FREE` requires a barrier synchronization: no process can return from free until all processes in the group of `win` called free. This[,] is to ensure that no process will attempt to access a remote window (e.g., with lock/unlock) after it was freed. The only exception to this rule is when the user sets the `no_locks` info [argument]key to true when creating the window. In that case, the local window can be freed without barrier synchronization. (*End of advice to implementors.*)

11.2.6 Window Attributes

The following [three] attributes are cached with a window[,] when the window is created.

<code>MPI_WIN_BASE</code>	window base address.
<code>MPI_WIN_SIZE</code>	[]window size, in bytes.
<code>MPI_WIN_DISP_UNIT</code>	displacement unit associated with the window.
[ticket270.] <code>MPI_WIN_CREATE_FLAVOR</code>	how the window was created.
[ticket270.] <code>MPI_WIN_MODEL</code>	memory model for window.

In C, calls to `MPI_Win_get_attr(win, MPI_WIN_BASE, &base, &flag)`, `MPI_Win_get_attr(win, MPI_WIN_SIZE, &size, &flag)` [and], `MPI_Win_get_attr(win, MPI_WIN_DISP_UNIT, &disp_unit, &flag)`, `MPI_Win_get_attr(win, MPI_WIN_CREATE_FLAVOR, &create_kind, &flag)`, and `MPI_Win_get_attr(win, MPI_WIN_MODEL, &memory_model, &flag)` will return in `base` a pointer to the start of the window `win`, and will return in `size` [and], `disp_unit`, `create_kind`, and `memory_model` pointers to the size [and], displacement unit of the window, the kind of routine used to create the window, and the memory model, respectively. [And similarly, in C++.]And similarly, in C++ (*binding deprecated, see Section 15.2*). A detailed listing of the type of the pointer in the attribute value argument to `MPI_Win_get_attr` and `MPI_Win_set_attr` is shown in Table 11.1.

In Fortran, calls to `MPI_WIN_GET_ATTR(win, MPI_WIN_BASE, base, flag, ierror)`, `MPI_WIN_GET_ATTR(win, MPI_WIN_SIZE, size, flag, ierror)` [and], `MPI_WIN_GET_ATTR(win, MPI_WIN_DISP_UNIT, disp_unit, flag, ierror)`, `MPI_WIN_GET_ATTR(win, MPI_WIN_CREATE_FLAVOR, create_kind, flag, ierror)`, and `MPI_WIN_GET_ATTR(win, MPI_WIN_MODEL, memory_model, flag, ierror)` will return in

Attribute	C Type
MPI_WIN_BASE	void *
MPI_WIN_SIZE	MPI_Aint *
MPI_WIN_DISP_UNIT	int *
MPI_WIN_CREATE_FLAVOR	int *
MPI_WIN_MODEL	int *

Table 11.1: C types of attribute value argument to MPI_Win_get_attr and MPI_Win_set_attr.

base, size[and], disp_unit create_kind and memory_model the (integer representation of) the base address, the size[and], the displacement unit of the window win, the kind of routine used to create the window, and the memory model, respectively.

The values of create_kind are

MPI_WIN_FLAVOR_CREATE	Window was created with MPI_WIN_CREATE.
MPI_WIN_FLAVOR_ALLOCATE	Window was created with MPI_WIN_ALLOCATE.
MPI_WIN_FLAVOR_DYNAMIC	Window was created with MPI_WIN_CREATE_DYNAMIC.
MPI_WIN_FLAVOR_SHARED	Window was created with MPI_WIN_ALLOCATE_SHARED.

The values of memory_model are MPI_WIN_SEPARATE and MPI_WIN_UNIFIED. The meaning of these is described in Section 11.4.

In the case of windows created with MPI_WIN_CREATE_DYNAMIC, the base address is MPI_BOTTOM and the size is 0. In C, pointers are returned and in Fortran, the values are returned, for the respective attributes. (The window attribute access functions are defined in Section 6.7.3, page 285.) The value returned for an attribute on a window is constant over the lifetime of the window.

The other “window attribute,” namely the group of processes attached to the window, can be retrieved using the call below.

MPI_WIN_GET_GROUP(win, group)

IN	win	window object (handle)
OUT	group	group of processes which share access to the window (handle)

int MPI_Win_get_group(MPI_Win win, MPI_Group *group)

```
MPI_Win_get_group(win, group, ierror) BIND(C)
  TYPE(MPI_Win), INTENT(IN) :: win
  TYPE(MPI_Group), INTENT(OUT) :: group
  INTEGER, OPTIONAL, INTENT(OUT) :: ierror
```

```
MPI_WIN_GET_GROUP(WIN, GROUP, IERROR)
  INTEGER WIN, GROUP, IERROR
```

```
{MPI::Group MPI::Win::Get_group() const(binding deprecated, see Section 15.2) }
```

MPI_WIN_GET_GROUP returns a duplicate of the group of the communicator used to create the window[.] associated with win. The group is returned in group.

11.3 Communication Calls

MPI supports [three]the following RMA communication calls: MPI_PUT [transfers]and MPI_RPUT transfer data from the caller memory (origin) to the target memory; MPI_GET [transfers]and MPI_RGET transfer data from the target memory to the caller memory; [and] MPI_ACCUMULATE [updates]and MPI_RACCUMULATE update locations in the target memory, e.g., by adding to these locations values sent from the caller memory[.]; MPI_GET_ACCUMULATE, MPI_RGET_ACCUMULATE and MPI_FETCH_AND_OP atomically return the data before the accumulate operation; and MPI_COMPARE_AND_SWAP performs a remote compare and swap operation. These operations are *nonblocking*: the call initiates the transfer, but the transfer may continue after the call returns. The transfer is completed, both at the origin and at the target, when a subsequent *synchronization* call is issued by the caller on the involved window object. These synchronization calls are described in Section 11.5, page 456. Transfers can also be completed with calls to flush routines; see Section 11.5.4, page 469 for details. For the MPI_RPUT, MPI_RGET, MPI_RACCUMULATE, and MPI_RGET_ACCUMULATE calls, the transfer can be locally completed by using the MPI test or wait operations described in Section 3.7.3, page 58.

The local communication buffer of an RMA call should not be updated, and the local communication buffer of a get call should not be accessed after the RMA call[.] until the [subsequent synchronization call completes.]operation completes at the origin.

[It is erroneous to have concurrent conflicting accesses to the same memory location in a window]The outcome of concurrent conflicting accesses to the same memory locations is undefined; if a location is updated by a put or accumulate operation, then [this location cannot be accessed by a load or another RMA operation]the outcome of [local] loads or other RMA operations is undefined until the updating operation has completed at the target. There is one exception to this rule; namely, the same location can be updated by several concurrent accumulate calls, the outcome being as if these updates occurred in some order. In addition, [if a window cannot concurrently be updated by a put or accumulate operation and by a local store operation. This, even if these two updates access different locations in the window. The last restriction enables more efficient implementations of RMA operations on many systems.]the outcome of concurrent [local]load/store and RMA updates to the same memory location is undefined. These restrictions are described in more detail in Section 11.7, page 473.

The calls use general datatype arguments to specify communication buffers at the origin and at the target. Thus, a transfer operation may also gather data at the source and scatter it at the destination. However, all arguments specifying both communication buffers are provided by the caller.

For all [three]RMA calls, the target process may be identical with the origin process; i.e., a process may use an RMA operation to move data in its memory.

Rationale. The choice of supporting “self-communication” is the same as for message-passing. It simplifies some coding, and is very useful with accumulate operations, to allow atomic updates of local variables. (*End of rationale.*)

ticket270. 1 MPI_PROC_NULL is a valid target rank in [the MPI RMA calls MPI_ACCUMULATE,
 2 MPI_GET, and MPI_PUT]all MPI RMA communication calls. The effect is the same as
 3 for MPI_PROC_NULL in MPI point-to-point communication. After any RMA operation with
 4 rank MPI_PROC_NULL, it is still necessary to finish the RMA epoch with the synchronization
 5 method that started the epoch.
 6

7 11.3.1 Put

8
 9 The execution of a put operation is similar to the execution of a send by the origin process
 10 and a matching receive by the target process. The obvious difference is that all arguments
 11 are provided by one call — the call executed by the origin process.
 12

13 MPI_PUT(origin_addr, origin_count, origin_datatype, target_rank, target_disp, target_count,
 14 target_datatype, win)

15			
16	IN	origin_addr	initial address of origin buffer (choice)
17	IN	origin_count	number of entries in origin buffer (non-negative integer)
18			
19	IN	origin_datatype	datatype of each entry in origin buffer (handle)
20	IN	target_rank	rank of target (non-negative integer)
21	IN	target_disp	displacement from start of window to target buffer (non-negative integer)
22	IN	target_count	number of entries in target buffer (non-negative integer)
23			
24	IN	target_datatype	datatype of each entry in target buffer (handle)
25	IN	win	window object used for communication (handle)
26			
27			
28			
29			

ticket140. 30 int MPI_Put(const void *origin_addr, int origin_count, MPI_Datatype
 31 origin_datatype, int target_rank, MPI_Aint target_disp, int
 32 target_count, MPI_Datatype target_datatype, MPI_Win win)

ticket229.2. 33 MPI_Put(origin_addr, origin_count, origin_datatype, target_rank,
 ticket-248T. 34 target_disp, target_count, target_datatype, win, ierror)
 35 BIND(C)
 36 TYPE(*), DIMENSION(..), INTENT(IN), ASYNCHRONOUS :: origin_addr
 37 INTEGER, INTENT(IN) :: origin_count, target_rank, target_count
 38 TYPE(MPI_Datatype), INTENT(IN) :: origin_datatype, target_datatype
 39 INTEGER(KIND=MPI_ADDRESS_KIND), INTENT(IN) :: target_disp
 40 TYPE(MPI_Win), INTENT(IN) :: win
 41 INTEGER, OPTIONAL, INTENT(OUT) :: ierror

42
 43 MPI_PUT(ORIGIN_ADDR, ORIGIN_COUNT, ORIGIN_DATATYPE, TARGET_RANK,
 44 TARGET_DISP, TARGET_COUNT, TARGET_DATATYPE, WIN, IERROR)
 45 <type> ORIGIN_ADDR(*)
 46 INTEGER(KIND=MPI_ADDRESS_KIND) TARGET_DISP
 47 INTEGER ORIGIN_COUNT, ORIGIN_DATATYPE, TARGET_RANK, TARGET_COUNT,
 48 TARGET_DATATYPE, WIN, IERROR

```
{void MPI::Win::Put(const void* origin_addr, int origin_count,
                   const MPI::Datatype& origin_datatype, int target_rank,
                   MPI::Aint target_disp, int target_count,
                   const MPI::Datatype& target_datatype) const(binding deprecated,
                   see Section 15.2) }
```

Transfers `origin_count` successive entries of the type specified by the `origin_datatype`, starting at address `origin_addr` on the origin node to the target node specified by the `win`, `target_rank` pair. The data are written in the target buffer at address `target_addr = window_base + target_disp × disp_unit`, where `window_base` and `disp_unit` are the base address and window displacement unit specified at window initialization, by the target process.

The target buffer is specified by the arguments `target_count` and `target_datatype`.

The data transfer is the same as that which would occur if the origin process executed a send operation with arguments `origin_addr`, `origin_count`, `origin_datatype`, `target_rank`, `tag`, `comm`, and the target process executed a receive operation with arguments `target_addr`, `target_count`, `target_datatype`, `source`, `tag`, `comm`, where `target_addr` is the target buffer address computed as explained above, **the values of tag are arbitrary valid matching tag values**, and `comm` is a communicator for the group of `win`.

The communication must satisfy the same constraints as for a similar message-passing communication. The `target_datatype` may not specify overlapping entries in the target buffer. The message sent must fit, without truncation, in the target buffer. Furthermore, the target buffer must fit in the target window **or in attached memory in a dynamic window**.

The `target_datatype` argument is a handle to a datatype object defined at the origin process. However, this object is interpreted at the target process: the outcome is as if the target datatype object was defined at the target process[,] by the same sequence of calls used to define it at the origin process. The target datatype must contain only relative displacements, not absolute addresses. The same holds for `get` and `accumulate`. **[In the case of windows created with `MPI_WIN_CREATE_DYNAMIC`, displacements in the target datatype must be relative to `MPI_BOTTOM`.]**

Advice to users. The `target_datatype` argument is a handle to a datatype object that is defined at the origin process, even though it defines a data layout in the target process memory. This causes no problems in a homogeneous environment, or in a heterogeneous environment[,] if only portable datatypes are used (portable datatypes are defined in Section 2.4, page 11).

The performance of a `put` transfer can be significantly affected, on some systems, **[from]by** the choice of window location and the shape and location of the origin and target buffer: transfers to a target window in memory allocated by `MPI_ALLOC_MEM` **or `MPI_WIN_ALLOCATE`** may be much faster on shared memory systems; transfers from contiguous buffers will be faster on most, if not all, systems; the alignment of the communication buffers may also impact performance. (*End of advice to users.*)

Advice to implementors. A high-quality implementation will attempt to prevent remote accesses to memory outside the window that was exposed by the process. This, both for debugging purposes, and for protection with client-server codes that use RMA. I.e., a high-quality implementation will check, if possible, window bounds on each RMA call, and raise an MPI exception at the origin call if an out-of-bound situation occurred. Note that the condition can be checked at the origin. Of course,

1 the added safety achieved by such checks has to be weighed against the added cost of
 2 such checks. (*End of advice to implementors.*)

4 11.3.2 Get

7 MPI_GET(origin_addr, origin_count, origin_datatype, target_rank, target_disp, target_count,
 8 target_datatype, win)

10	OUT	origin_addr	initial address of origin buffer (choice)
11	IN	origin_count	number of entries in origin buffer (non-negative integer)
12			
13	IN	origin_datatype	datatype of each entry in origin buffer (handle)
14			
15	IN	target_rank	rank of target (non-negative integer)
16	IN	target_disp	displacement from window start to the beginning of the target buffer (non-negative integer)
17			
18	IN	target_count	number of entries in target buffer (non-negative integer)
19			
20			
21	IN	target_datatype	datatype of each entry in target buffer (handle)
22	IN	win	window object used for communication (handle)

24 int MPI_Get(void *origin_addr, int origin_count,
 25 MPI_Datatype origin_datatype, int target_rank,
 26 MPI_Aint target_disp, int target_count,
 27 MPI_Datatype target_datatype, MPI_Win win)

ticket229.2. 28 MPI_Get(origin_addr, origin_count, origin_datatype, target_rank,
 ticket-248T. 29 target_disp, target_count, target_datatype, win, ierror)
 30 BIND(C)
 31 TYPE(*), DIMENSION(..), ASYNCHRONOUS :: origin_addr
 32 INTEGER, INTENT(IN) :: origin_count, target_rank, target_count
 33 TYPE(MPI_Datatype), INTENT(IN) :: origin_datatype, target_datatype
 34 INTEGER(KIND=MPI_ADDRESS_KIND), INTENT(IN) :: target_disp
 35 TYPE(MPI_Win), INTENT(IN) :: win
 36 INTEGER, OPTIONAL, INTENT(OUT) :: ierror

38 MPI_GET(ORIGIN_ADDR, ORIGIN_COUNT, ORIGIN_DATATYPE, TARGET_RANK,
 39 TARGET_DISP, TARGET_COUNT, TARGET_DATATYPE, WIN, IERROR)
 40 <type> ORIGIN_ADDR(*)
 41 INTEGER(KIND=MPI_ADDRESS_KIND) TARGET_DISP
 42 INTEGER ORIGIN_COUNT, ORIGIN_DATATYPE, TARGET_RANK, TARGET_COUNT,
 43 TARGET_DATATYPE, WIN, IERROR

45 {void MPI::Win::Get(void *origin_addr, int origin_count,
 46 const MPI::Datatype& origin_datatype, int target_rank,
 47 MPI::Aint target_disp, int target_count,
 48

```
const MPI::Datatype& target_datatype) const(binding deprecated,
    see Section 15.2) }
```

Similar to MPI_PUT, except that the direction of data transfer is reversed. Data are copied from the target memory to the origin. The origin_datatype may not specify overlapping entries in the origin buffer. The target buffer must be contained within the target window or within attached memory in a dynamic window, and the copied data must fit, without truncation, in the origin buffer.

11.3.3 Examples for Communication Calls

These examples show the use of the MPI_GET function. As all MPI RMA communication functions are nonblocking, they must be completed. In the following, this is accomplished with the routine MPI_WIN_FENCE, introduced in Section 11.5.

Example 11.1 We show how to implement the generic indirect assignment $A = B(\text{map})$, where A, B and map have the same distribution, and map is a permutation. To simplify, we assume a block distribution with equal size blocks.

```
SUBROUTINE MAPVALS(A, B, map, m, comm, p)
USE MPI
INTEGER m, map(m), comm, p
REAL A(m), B(m)

INTEGER otype(p), oindex(m),      & ! used to construct origin datatypes
      ttype(p), tindex(m),        & ! used to construct target datatypes
      count(p), total(p),        &
      win, ierr
INTEGER (KIND=MPI_ADDRESS_KIND) lowerbound, sizeofreal

! This part does the work that depends on the locations of B.
! Can be reused while this does not change

CALL MPI_TYPE_GET_EXTENT(MPI_REAL, lowerbound, sizeofreal, ierr)
CALL MPI_WIN_CREATE(B, m*sizeofreal, sizeofreal, MPI_INFO_NULL, &
      comm, win, ierr)

! This part does the work that depends on the value of map and
! the locations of the arrays.
! Can be reused while these do not change

! Compute number of entries to be received from each process

DO i=1,p
  count(i) = 0
END DO
DO i=1,m
  j = map(i)/m+1
  count(j) = count(j)+1
```

```

1  END DO
2
3  total(1) = 0
4  DO i=2,p
5      total(i) = total(i-1) + count(i-1)
6  END DO
7
8  DO i=1,p
9      count(i) = 0
10 END DO
11
12 ! compute origin and target indices of entries.
13 ! entry i at current process is received from location
14 ! k at process (j-1), where map(i) = (j-1)*m + (k-1),
15 ! j = 1..p and k = 1..m
16
17 DO i=1,m
18     j = map(i)/m+1
19     k = MOD(map(i),m)+1
20     count(j) = count(j)+1
21     oindex(total(j) + count(j)) = i
22     tindex(total(j) + count(j)) = k
23 END DO
24
25 ! create origin and target datatypes for each get operation
26 DO i=1,p
27     CALL MPI_TYPE_CREATE_INDEXED_BLOCK(count(i), 1, oindex(total(i)+1), &
28                                     MPI_REAL, otype(i), ierr)
29     CALL MPI_TYPE_COMMIT(otype(i), ierr)
30     CALL MPI_TYPE_CREATE_INDEXED_BLOCK(count(i), 1, tindex(total(i)+1), &
31                                     MPI_REAL, ttype(i), ierr)
32     CALL MPI_TYPE_COMMIT(ttype(i), ierr)
33 END DO
34
35 ! this part does the assignment itself
36 CALL MPI_WIN_FENCE(0, win, ierr)
37 DO i=1,p
38     CALL MPI_GET(A, 1, otype(i), i-1, 0, 1, ttype(i), win, ierr)
39 END DO
40 CALL MPI_WIN_FENCE(0, win, ierr)
41
42 CALL MPI_WIN_FREE(win, ierr)
43 DO i=1,p
44     CALL MPI_TYPE_FREE(otype(i), ierr)
45     CALL MPI_TYPE_FREE(ttype(i), ierr)
46 END DO
47 RETURN
48 END

```

Example 11.2

A simpler version can be written that does not require that a datatype be built for the target buffer. But, one then needs a separate get call for each entry, as illustrated below. This code is much simpler, but usually much less efficient, for large arrays.

```

SUBROUTINE MAPVALS(A, B, map, m, comm, p)
USE MPI
INTEGER m, map(m), comm, p
REAL A(m), B(m)
INTEGER win, ierr
INTEGER (KIND=MPI_ADDRESS_KIND) lowerbound, sizeofreal

CALL MPI_TYPE_GET_EXTENT(MPI_REAL, lowerbound, sizeofreal, ierr)
CALL MPI_WIN_CREATE(B, m*sizeofreal, sizeofreal, MPI_INFO_NULL, &
                   comm, win, ierr)

CALL MPI_WIN_FENCE(0, win, ierr)
DO i=1,m
  j = map(i)/m
  k = MOD(map(i),m)
  CALL MPI_GET(A(i), 1, MPI_REAL, j, k, 1, MPI_REAL, win, ierr)
END DO
CALL MPI_WIN_FENCE(0, win, ierr)
CALL MPI_WIN_FREE(win, ierr)
RETURN
END

```

11.3.4 Accumulate Functions

It is often useful in a put operation to combine the data moved to the target process with the data that resides at that process, rather than replacing the data there. This will allow, for example, the accumulation of a sum by having all involved processes add their contribution to the sum variable in the memory of one process. **The accumulate functions have slightly different semantics than the put and get functions; see Section 11.7 for details.**

Accumulate Function

```

1 MPI_ACCUMULATE(origin_addr, origin_count, origin_datatype, target_rank, target_disp,
2   target_count, target_datatype, op, win)
3
4   IN      origin_addr      initial address of buffer (choice)
5   IN      origin_count     number of entries in buffer (non-negative integer)
6   IN      origin_datatype  datatype of each entry (handle)
7   IN      target_rank      rank of target (non-negative integer)
8   IN      target_disp     displacement from start of window to beginning of tar-
9   IN      target_count     number of entries in target buffer (non-negative inte-
10  target_disp              get buffer (non-negative integer)
11  IN      target_count     number of entries in target buffer (non-negative inte-
12  target_count            ger)
13  IN      target_datatype  datatype of each entry in target buffer (handle)
14  IN      op               reduce operation (handle)
15  IN      win              window object (handle)
16
17

```

```

ticket140. 18 int MPI_Accumulate(const void *origin_addr, int origin_count,
19                MPI_Datatype origin_datatype, int target_rank,
20                MPI_Aint target_disp, int target_count,
21                MPI_Datatype target_datatype, MPI_Op op, MPI_Win win)

```

```

ticket229.2. 22 MPI_Accumulate(origin_addr, origin_count, origin_datatype, target_rank,
ticket-248T. 23 target_disp, target_count, target_datatype, op, win, ierror)
24 BIND(C)
25 TYPE(*), DIMENSION(..), INTENT(IN), ASYNCHRONOUS :: origin_addr
26 INTEGER, INTENT(IN) :: origin_count, target_rank, target_count
27 TYPE(MPI_Datatype), INTENT(IN) :: origin_datatype, target_datatype
28 INTEGER(KIND=MPI_ADDRESS_KIND), INTENT(IN) :: target_disp
29 TYPE(MPI_Op), INTENT(IN) :: op
30 TYPE(MPI_Win), INTENT(IN) :: win
31 INTEGER, OPTIONAL, INTENT(OUT) :: ierror
32

```

```

33 MPI_ACCUMULATE(ORIGIN_ADDR, ORIGIN_COUNT, ORIGIN_DATATYPE, TARGET_RANK,
34   TARGET_DISP, TARGET_COUNT, TARGET_DATATYPE, OP, WIN, IERROR)
35 <type> ORIGIN_ADDR(*)
36 INTEGER(KIND=MPI_ADDRESS_KIND) TARGET_DISP
37 INTEGER ORIGIN_COUNT, ORIGIN_DATATYPE, TARGET_RANK, TARGET_COUNT,
38 TARGET_DATATYPE, OP, WIN, IERROR
39

```

```

40 {void MPI::Win::Accumulate(const void* origin_addr, int origin_count, const
41   MPI::Datatype& origin_datatype, int target_rank, MPI::Aint
42   target_disp, int target_count, const MPI::Datatype&
43   target_datatype, const MPI::Op& op) const(binding deprecated, see
44   Section 15.2) }
45

```

46 Accumulate the contents of the origin buffer (as defined by `origin_addr`, `origin_count` and
47 `origin_datatype`) to the buffer specified by arguments `target_count` and `target_datatype`, at
48 offset `target_disp`, in the target window specified by `target_rank` and `win`, using the operation

op. This is like MPI_PUT except that data is combined into the target area instead of overwriting it.

Any of the predefined operations for MPI_REDUCE can be used. User-defined functions cannot be used. For example, if op is MPI_SUM, each element of the origin buffer is added to the corresponding element in the target, replacing the former value in the target.

Each datatype argument must be a predefined datatype or a derived datatype, where all basic components are of the same predefined datatype. Both datatype arguments must be constructed from the same predefined datatype. The operation op applies to elements of that predefined type. **The parameter target_datatype** must not specify overlapping entries, and the target buffer must fit in the target window.

A new predefined operation, MPI_REPLACE, is defined. It corresponds to the associative function $f(a, b) = b$; i.e., the current value in the target memory is replaced by the value supplied by the origin.

MPI_REPLACE can be used only in MPI_ACCUMULATE, **MPI_RACCUMULATE**, **MPI_GET_ACCUMULATE**, **MPI_FETCH_AND_OP**, and **MPI_RGET_ACCUMULATE**, but not in collective reduction operations[,] such as MPI_REDUCE.

Advice to users. MPI_PUT is a special case of MPI_ACCUMULATE, with the operation MPI_REPLACE. Note, however, that MPI_PUT and MPI_ACCUMULATE have different constraints on concurrent updates. (*End of advice to users.*)

Example 11.3 We want to compute $B(j) = \sum_{\text{map}(i)=j} A(i)$. The arrays A, B and map are distributed in the same manner. We write the simple version.

```

SUBROUTINE SUM(A, B, map, m, comm, p)
USE MPI
INTEGER m, map(m), comm, p, win, ierr
REAL A(m), B(m)
INTEGER (KIND=MPI_ADDRESS_KIND) lowerbound, sizeofreal

CALL MPI_TYPE_GET_EXTENT(MPI_REAL, lowerbound, sizeofreal, ierr)
CALL MPI_WIN_CREATE(B, m*sizeofreal, sizeofreal, MPI_INFO_NULL, &
                   comm, win, ierr)

CALL MPI_WIN_FENCE(0, win, ierr)
DO i=1,m
  j = map(i)/m
  k = MOD(map(i),m)
  CALL MPI_ACCUMULATE(A(i), 1, MPI_REAL, j, k, 1, MPI_REAL, &
                    MPI_SUM, win, ierr)
END DO
CALL MPI_WIN_FENCE(0, win, ierr)

CALL MPI_WIN_FREE(win, ierr)
RETURN
END

```

This code is identical to the code in Example 11.2, page 443, except that a call to get has been replaced by a call to accumulate. (Note that, if map is one-to-one, then the

code computes $B = A(\text{map}^{-1})$, which is the reverse assignment to the one computed in that previous example.) In a similar manner, we can replace in Example 11.1, page 441, the call to `get` by a call to `accumulate`, thus performing the computation with only one communication between any two processes.

Get Accumulate Function

It is often useful to have fetch-and-accumulate semantics such that the remote data is returned to the caller before the sent data is accumulated into the remote data. The `get` and `accumulate` steps are executed atomically for each basic element in the datatype (see Section 11.7 for details). The predefined operation `MPI_REPLACE` provides fetch-and-set behavior.

```
MPI_GET_ACCUMULATE(origin_addr,  origin_count,  origin_datatype,  result_addr,
                   result_count, result_datatype, target_rank, target_disp, target_count, target_datatype,
                   op, win)
IN      origin_addr      initial address of buffer (choice)
IN      origin_count     number of entries in origin buffer (non-negative integer)
IN      origin_datatype  datatype of each entry in origin buffer (handle)
OUT     result_addr      initial address of result buffer (choice)
IN      result_count     number of entries in result buffer (non-negative integer)
IN      result_datatype  datatype of each entry in result buffer (handle)
IN      target_rank      rank of target (non-negative integer)
IN      target_disp      displacement from start of window to beginning of target buffer (non-negative integer)
IN      target_count     number of entries in target buffer (non-negative integer)
IN      target_datatype  datatype of each entry in target buffer (handle)
IN      op                reduce operation (handle)
IN      win              window object (handle)
```

```
int MPI_Get_accumulate(const void *origin_addr, int origin_count,
                      MPI_Datatype origin_datatype, void *result_addr,
                      int result_count, MPI_Datatype result_datatype,
                      int target_rank, MPI_Aint target_disp, int target_count,
                      MPI_Datatype target_datatype, MPI_Op op, MPI_Win win)
```

```
MPI_Get_accumulate(origin_addr, origin_count, origin_datatype, result_addr,
                  result_count, result_datatype, target_rank, target_disp,
                  target_count, target_datatype, op, win, ierror) BIND(C)
TYPE(*), DIMENSION(..), INTENT(IN), ASYNCHRONOUS :: origin_addr
TYPE(*), DIMENSION(..), ASYNCHRONOUS :: result_addr
```

```

INTEGER, INTENT(IN) :: origin_count, result_count, target_rank,
target_count
TYPE(MPI_Datatype), INTENT(IN) :: origin_datatype, target_datatype,
result_datatype
INTEGER(KIND=MPI_ADDRESS_KIND), INTENT(IN) :: target_disp
TYPE(MPI_Op), INTENT(IN) :: op
TYPE(MPI_Win), INTENT(IN) :: win
INTEGER, OPTIONAL, INTENT(OUT) :: ierror
MPI_GET_ACCUMULATE(ORIGIN_ADDR, ORIGIN_COUNT, ORIGIN_DATATYPE, RESULT_ADDR,
RESULT_COUNT, RESULT_DATATYPE, TARGET_RANK, TARGET_DISP,
TARGET_COUNT, TARGET_DATATYPE, OP, WIN, IERROR)
<type> ORIGIN_ADDR(*), RESULT_ADDR(*)
INTEGER(KIND=MPI_ADDRESS_KIND) TARGET_DISP
INTEGER ORIGIN_COUNT, ORIGIN_DATATYPE, RESULT_COUNT, RESULT_DATATYPE,
TARGET_RANK, TARGET_COUNT, TARGET_DATATYPE, OP, WIN, IERROR

```

Accumulate `origin_count` elements of type `origin_datatype` from the origin buffer (`origin_addr`) to the buffer at offset `target_disp`, in the target window specified by `target_rank` and `win`, using the operation `op` and return in the result buffer `result_addr` the content of the target buffer before the accumulation.

The origin and result buffers (`origin_addr` and `result_addr`) must be disjoint. Each datatype argument must be a predefined datatype or a derived datatype where all basic components are of the same predefined datatype. All datatype arguments must be constructed from the same predefined datatype. The operation `op` applies to elements of that predefined type. `target_datatype` must not specify overlapping entries, and the target buffer must fit in the target window or in attached memory in a dynamic window. The operation is executed atomically for each basic datatype; see Section 11.7 for details.

Any of the predefined operations for `MPI_REDUCE`, and `MPI_NO_OP` or `MPI_REPLACE` can be specified as `op`. User-defined functions cannot be used. A new predefined operation, `MPI_NO_OP`, is defined. It corresponds to the associative function $f(a, b) = a$; i.e., the current value in the target memory is returned in the result buffer at the origin and no operation is performed on the target buffer. `MPI_NO_OP` can be used only in `MPI_GET_ACCUMULATE`, `MPI_RGET_ACCUMULATE`, and `MPI_FETCH_AND_OP`. `MPI_NO_OP` cannot be used in `MPI_ACCUMULATE`, `MPI_RACCUMULATE`, or collective reduction operations, such as `MPI_REDUCE` and others.

Advice to users. `MPI_GET` is similar to `MPI_GET_ACCUMULATE`, with the operation `MPI_NO_OP`. Note, however, that `MPI_GET` and `MPI_GET_ACCUMULATE` have different constraints on concurrent updates. (*End of advice to users.*)

Fetch and Op Function

The generic functionality of `MPI_GET_ACCUMULATE` might significantly limit the performance of fetch-and-increment or fetch-and-add calls that might be supported by special hardware operations. `MPI_FETCH_AND_OP` thus allows for a fast implementation of a commonly used subset of the functionality of `MPI_GET_ACCUMULATE`.

```
1 MPI_FETCH_AND_OP(origin_addr, result_addr, datatype, target_rank, target_disp, op, win)
```

```
2
3     IN     origin_addr     initial address of buffer (choice)
4
5     OUT    result_addr     initial address of result buffer (choice)
6
7     IN     datatype        datatype of the entry in origin, result, and target buffers (handle)
8
9     IN     target_rank     rank of target (non-negative integer)
10
11    IN     target_disp     displacement from start of window to beginning of target buffer (non-negative integer)
12
13    IN     op               reduce operation (handle)
14
15    IN     win              window object (handle)
```

```
ticket140a. 16 int MPI_Fetch_and_op(const void *origin_addr, void *result_addr,
17                    MPI_Datatype datatype, int target_rank, MPI_Aint target_disp,
18                    MPI_Op op, MPI_Win win)
```

```
ticket-248T. 19 MPI_Fetch_and_op(origin_addr, result_addr, datatype, target_rank,
20                target_disp, op, win, ierror) BIND(C)
21     TYPE(*), DIMENSION(..), INTENT(IN), ASYNCHRONOUS :: origin_addr
22     TYPE(*), DIMENSION(..), ASYNCHRONOUS :: result_addr
23     TYPE(MPI_Datatype), INTENT(IN) :: datatype
24     INTEGER, INTENT(IN) :: target_rank
25     INTEGER(KIND=MPI_ADDRESS_KIND), INTENT(IN) :: target_disp
26     TYPE(MPI_Op), INTENT(IN) :: op
27     TYPE(MPI_Win), INTENT(IN) :: win
28     INTEGER, OPTIONAL, INTENT(OUT) :: ierror
```

```
29
30 MPI_FETCH_AND_OP(ORIGIN_ADDR, RESULT_ADDR, DATATYPE, TARGET_RANK,
31                 TARGET_DISP, OP, WIN, IERROR)
32     <type> ORIGIN_ADDR(*), RESULT_ADDR(*)
33     INTEGER(KIND=MPI_ADDRESS_KIND) TARGET_DISP
34     INTEGER DATATYPE, TARGET_RANK, OP, WIN, IERROR
```

35 Accumulate one element of type `datatype` from the origin buffer (`origin_addr`) to the
36 buffer at offset `target_disp`, in the target window specified by `target_rank` and `win`, using
ticket270. 37 the operation `op` and return in the result buffer `result_addr` the content of the target buffer
38 before the accumulation.

39 The origin and result buffers (`origin_addr` and `result_addr`) must be disjoint. Any of the
40 predefined operations for `MPI_REDUCE`, as well as `MPI_NO_OP` or `MPI_REPLACE`, can be
41 specified as `op`. User-defined functions cannot be used. The `datatype` argument must be a
42 predefined datatype. The operation is executed atomically.

44 Compare and Swap Function

45
46 Another useful operation is an atomic compare and swap where the value at the origin is
ticket270. 47 compared to the value at the target, which is atomically replaced by a third value only if
48 origin and target are equal.

```
MPI_COMPARE_AND_SWAP(origin_addr, compare_addr, result_addr, datatype, target_rank,
                      target_disp, win)
```

IN	origin_addr	initial address of buffer (choice)	1
			2
			3
IN	compare_addr	initial address of compare buffer (choice)	4
			5
OUT	result_addr	initial address of result buffer (choice)	6
			7
IN	datatype	datatype of the element in all buffers (handle)	8
			9
IN	target_rank	rank of target (non-negative integer)	10
			11
IN	target_disp	displacement from start of window to beginning of target buffer (non-negative integer)	12
			13
IN	win	window object (handle)	14

```
int MPI_Compare_and_swap(const void *origin_addr, const void *compare_addr,
                        void *result_addr, MPI_Datatype datatype, int target_rank,
                        MPI_Aint target_disp, MPI_Win win)
```

```
MPI_Compare_and_swap(origin_addr, compare_addr, result_addr, datatype,
                    target_rank, target_disp, win, ierror) BIND(C)
    TYPE(*), DIMENSION(..), INTENT(IN), ASYNCHRONOUS :: origin_addr,
    compare_addr
    TYPE(*), DIMENSION(..), ASYNCHRONOUS :: result_addr
    TYPE(MPI_Datatype), INTENT(IN) :: datatype
    INTEGER, INTENT(IN) :: target_rank
    INTEGER(KIND=MPI_ADDRESS_KIND), INTENT(IN) :: target_disp
    TYPE(MPI_Win), INTENT(IN) :: win
    INTEGER, OPTIONAL, INTENT(OUT) :: ierror
```

```
MPI_COMPARE_AND_SWAP(ORIGIN_ADDR, COMPARE_ADDR, RESULT_ADDR, DATATYPE,
                    TARGET_RANK, TARGET_DISP, WIN, IERROR)
    <type> ORIGIN_ADDR(*), COMPARE_ADDR(*), RESULT_ADDR(*)
    INTEGER(KIND=MPI_ADDRESS_KIND) TARGET_DISP
    INTEGER DATATYPE, TARGET_RANK, WIN, IERROR
```

This function compares one element of type `datatype` in the compare buffer `compare_addr` with the buffer at offset `target_disp` in the target window specified by `target_rank` and `win` and replaces the value at the target with the value in the origin buffer `origin_addr` if the compare buffer and the target buffer are identical. The original value at the target is returned in the buffer `result_addr`. The parameter `datatype` must belong to one of the following categories of predefined datatypes: C integer, Fortran integer, Logical, [Complex,]or Byte as specified in Section 5.9.2 on page 188[, or can be of type `MPI_AINT` or `MPI_OFFSET`]. The origin and result buffers (`origin_addr` and `result_addr`) must be disjoint. [Any of the predefined operations for `MPI_REDUCE`, and `MPI_NO_OP` or `MPI_REPLACE` can be specified as `op`. User-defined functions cannot be used. The outcome of accumulate operations with overlapping types of different sizes or target displacements is undefined, see Section 11.7.1.]

11.3.5 Request-based RMA Communication Operations

Request-based RMA communication operations allow the user to associate a request handle with the RMA operations and test or wait for the completion of these requests using the functions described in Section 3.7.3, page 58. Request-based RMA operations are only valid within a passive-target epoch.

Upon returning from a completion call in which an RMA operation completes, the `MPI_ERROR` field in the associated status object is set appropriately (see Section 3.2.5 on page 34). [The values of the `MPI_SOURCE` and `MPI_TAG` fields are undefined.] All other fields of status and the results of status query functions (e.g., `MPI_GET_COUNT`) are undefined. It is valid to mix different request types ([i.e.] e.g., any combination of RMA requests, collective requests, I/O requests, generalized requests, or point-to-point requests) in functions that enable multiple completions (e.g., `MPI_WAITALL`). It is erroneous to call `MPI_REQUEST_FREE` or `MPI_CANCEL` for a request associated with an RMA operation. RMA requests are not persistent.

The end of the epoch, or explicit bulk synchronization using `MPI_WIN_FLUSH`, `MPI_WIN_FLUSH_ALL`, `MPI_WIN_FLUSH_LOCAL` or `MPI_WIN_FLUSH_LOCAL_ALL`, also indicates completion of the RMA operations. However, users must still wait or test on the request handle to allow the MPI implementation to clean up any resources associated with these requests; in such cases the wait operation will complete locally.

```
MPI_RPUT(origin_addr, origin_count, origin_datatype, target_rank, target_disp, target_count,
        target_datatype, win, request)
```

IN	<code>origin_addr</code>	initial address of origin buffer (choice)
IN	<code>origin_count</code>	number of entries in origin buffer (non-negative integer)
IN	<code>origin_datatype</code>	datatype of each entry in origin buffer (handle)
IN	<code>target_rank</code>	rank of target (non-negative integer)
IN	<code>target_disp</code>	displacement from start of window to target buffer (non-negative integer)
IN	<code>target_count</code>	number of entries in target buffer (non-negative integer)
IN	<code>target_datatype</code>	datatype of each entry in target buffer (handle)
IN	<code>win</code>	window object used for communication (handle)
OUT	<code>request</code>	RMA request (handle)

```
int MPI_Rput(const void *origin_addr, int origin_count,
            MPI_Datatype origin_datatype, int target_rank,
            MPI_Aint target_disp, int target_count,
            MPI_Datatype target_datatype, MPI_Win win,
            MPI_Request *request)
```

```
MPI_Rput(origin_addr, origin_count, origin_datatype, target_rank,
        target_disp, target_count, target_datatype, win, request,
        ierror) BIND(C)
```

```

TYPE(*), DIMENSION(..), INTENT(IN), ASYNCHRONOUS :: origin_addr      1
INTEGER, INTENT(IN) :: origin_count, target_rank, target_count      2
TYPE(MPI_Datatype), INTENT(IN) :: origin_datatype, target_datatype  3
INTEGER(KIND=MPI_ADDRESS_KIND), INTENT(IN) :: target_disp          4
TYPE(MPI_Win), INTENT(IN) :: win                                    5
TYPE(MPI_Request), INTENT(OUT) :: request                          6
INTEGER, OPTIONAL, INTENT(OUT) :: ierror                          7
                                                                    8
MPI_RPUT(ORIGIN_ADDR, ORIGIN_COUNT, ORIGIN_DATATYPE, TARGET_RANK,   9
        TARGET_DISP, TARGET_COUNT, TARGET_DATATYPE, WIN, REQUEST, 10
        IERROR)                                                    11
<type> ORIGIN_ADDR(*)                                             12
INTEGER(KIND=MPI_ADDRESS_KIND) TARGET_DISP                       13
INTEGER ORIGIN_COUNT, ORIGIN_DATATYPE, TARGET_RANK, TARGET_COUNT, 14
TARGET_DATATYPE, WIN, REQUEST, IERROR                             15

```

MPI_RPUT is similar to MPI_PUT (Section 11.3.1), except that it allocates a communication request object and associates it with the request handle (the argument `request`). The completion of an MPI_RPUT operation (i.e., after the corresponding test or wait) indicates that the sender is now free to update the locations in the origin buffer. It does not indicate that the data is available at the target window. If remote completion is required, MPI_WIN_FLUSH, MPI_WIN_FLUSH_ALL, MPI_WIN_UNLOCK or MPI_WIN_UNLOCK_ALL can be used.

```

MPI_RGET(origin_addr, origin_count, origin_datatype, target_rank, target_disp, target_count,
        target_datatype, win, request)

```

OUT	origin_addr	initial address of origin buffer (choice)	27
IN	origin_count	number of entries in origin buffer (non-negative integer)	28
IN	origin_datatype	datatype of each entry in origin buffer (handle)	29
IN	target_rank	rank of target (non-negative integer)	30
IN	target_disp	displacement from window start to the beginning of the target buffer (non-negative integer)	31
IN	target_count	number of entries in target buffer (non-negative integer)	32
IN	target_datatype	datatype of each entry in target buffer (handle)	33
IN	win	window object used for communication (handle)	34
OUT	request	RMA request (handle)	35

```

int MPI_Rget(void *origin_addr, int origin_count,
             MPI_Datatype origin_datatype, int target_rank,
             MPI_Aint target_disp, int target_count,
             MPI_Datatype target_datatype, MPI_Win win,
             MPI_Request *request)

```

48 ticket-248T.

```

1 MPI_Rget(origin_addr, origin_count, origin_datatype, target_rank,
2         target_disp, target_count, target_datatype, win, request,
3         ierror) BIND(C)
4     TYPE(*), DIMENSION(..), ASYNCHRONOUS :: origin_addr
5     INTEGER, INTENT(IN) :: origin_count, target_rank, target_count
6     TYPE(MPI_Datatype), INTENT(IN) :: origin_datatype, target_datatype
7     INTEGER(KIND=MPI_ADDRESS_KIND), INTENT(IN) :: target_disp
8     TYPE(MPI_Win), INTENT(IN) :: win
9     TYPE(MPI_Request), INTENT(OUT) :: request
10    INTEGER, OPTIONAL, INTENT(OUT) :: ierror

```

```

11 MPI_RGET(ORIGIN_ADDR, ORIGIN_COUNT, ORIGIN_DATATYPE, TARGET_RANK,
12         TARGET_DISP, TARGET_COUNT, TARGET_DATATYPE, WIN, REQUEST,
13         IERROR)
14     <type> ORIGIN_ADDR(*)
15     INTEGER(KIND=MPI_ADDRESS_KIND) TARGET_DISP
16     INTEGER ORIGIN_COUNT, ORIGIN_DATATYPE, TARGET_RANK, TARGET_COUNT,
17     TARGET_DATATYPE, WIN, REQUEST, IERROR

```

19 MPI_RGET is similar to MPI_GET (Section 11.3.2), except that it allocates a commu-
20 nication request object and associates it with the request handle (the argument request)
21 that can be used to wait or test for completion. The completion of an MPI_RGET operation
22 indicates that the data is available in the origin buffer. If origin_addr points to memory
23 attached to a window, then the data becomes available in the private copy of this window.

```

24
25
26 MPI_RACCUMULATE(origin_addr, origin_count, origin_datatype, target_rank, target_disp,
27                 target_count, target_datatype, op, win, request)

```

28	IN	origin_addr	initial address of buffer (choice)
29	IN	origin_count	number of entries in buffer (non-negative integer)
30	IN	origin_datatype	datatype of each buffer entry (handle)
31	IN	target_rank	rank of target (non-negative integer)
32	IN	target_disp	displacement from start of window to beginning of tar- get buffer (non-negative integer)
33	IN	target_count	number of entries in target buffer (non-negative inte- ger)
34	IN	target_datatype	datatype of each entry in target buffer (handle)
35	IN	op	reduce operation (handle)
36	IN	win	window object (handle)
37	OUT	request	RMA request (handle)

```

38
39
40
41
42
43
44 int MPI_Raccumulate(const void *origin_addr, int origin_count,
45                   MPI_Datatype origin_datatype, int target_rank,
46                   MPI_Aint target_disp, int target_count,
47                   MPI_Datatype target_datatype, MPI_Op op, MPI_Win win,
48                   MPI_Request *request)

```

ticket140a.

```

MPI_Raccumulate(origin_addr, origin_count, origin_datatype, target_rank,
                target_disp, target_count, target_datatype, op, win, request,
                ierror) BIND(C)
    TYPE(*), DIMENSION(..), INTENT(IN), ASYNCHRONOUS :: origin_addr
    INTEGER, INTENT(IN) :: origin_count, target_rank, target_count
    TYPE(MPI_Datatype), INTENT(IN) :: origin_datatype, target_datatype
    INTEGER(KIND=MPI_ADDRESS_KIND), INTENT(IN) :: target_disp
    TYPE(MPI_Op), INTENT(IN) :: op
    TYPE(MPI_Win), INTENT(IN) :: win
    TYPE(MPI_Request), INTENT(OUT) :: request
    INTEGER, OPTIONAL, INTENT(OUT) :: ierror

MPI_RACCUMULATE(ORIGIN_ADDR, ORIGIN_COUNT, ORIGIN_DATATYPE, TARGET_RANK,
                TARGET_DISP, TARGET_COUNT, TARGET_DATATYPE, OP, WIN, REQUEST,
                IERROR)
    <type> ORIGIN_ADDR(*)
    INTEGER(KIND=MPI_ADDRESS_KIND) TARGET_DISP
    INTEGER ORIGIN_COUNT, ORIGIN_DATATYPE, TARGET_RANK, TARGET_COUNT,
    TARGET_DATATYPE, OP, WIN, REQUEST, IERROR

```

MPI_RACCUMULATE is similar to MPI_ACCUMULATE (Section 11.3.4), except that it allocates a communication request object and associates it with the request handle (the argument request) that can be used to wait or test for completion. The completion of an MPI_RACCUMULATE operation indicates that the origin buffer is free to be updated. It does not indicate that the operation has completed at the target window.

1
2 ticket-248T.3
4
5
6
7
8
9
10
11
12
13
14
15
16
17
18
19
20
21
22
23
24
25
26
27
28
29
30
31
32
33
34
35
36
37
38
39
40
41
42
43
44
45
46
47
48

```

1 MPI_RGET_ACCUMULATE(origin_addr, origin_count, origin_datatype, result_addr,
2     result_count, result_datatype, target_rank, target_disp, target_count, target_datatype,
3     op, win, request)
4
5     IN     origin_addr     initial address of buffer (choice)
6
7     IN     origin_count    number of entries in origin buffer (non-negative inte-
8                                     ger)
9
10    IN     origin_datatype  datatype of each buffer entry (handle)
11
12    OUT    result_addr      initial address of result buffer (choice)
13
14    IN     result_count     number of entries in result buffer (non-negative inte-
15                                     ger)
16
17    IN     result_datatype  datatype of each buffer entry (handle)
18
19    IN     target_rank      rank of target (non-negative integer)
20
21    IN     target_disp      displacement from start of window to beginning of tar-
22                                     get buffer (non-negative integer)
23
24    IN     target_count     number of entries in target buffer (non-negative inte-
25                                     ger)
26
27    IN     target_datatype  datatype of each buffer entry (handle)
28
29    IN     op               reduce operation (handle)
30
31    IN     win              window object (handle)
32
33    OUT    request          RMA request (handle)

```

```

ticket140a. 27 int MPI_Rget_accumulate(const void *origin_addr, int origin_count,
28     MPI_Datatype origin_datatype, void *result_addr,
29     int result_count, MPI_Datatype result_datatype,
30     int target_rank, MPI_Aint target_disp, int target_count,
31     MPI_Datatype target_datatype, MPI_Op op, MPI_Win win,
32     MPI_Request *request)

```

```

ticket-248T. 33 MPI_Rget_accumulate(origin_addr, origin_count, origin_datatype,
34     result_addr, result_count, result_datatype, target_rank,
35     target_disp, target_count, target_datatype, op, win, request,
36     ierror) BIND(C)
37     TYPE(*), DIMENSION(..), INTENT(IN), ASYNCHRONOUS :: origin_addr
38     TYPE(*), DIMENSION(..), ASYNCHRONOUS :: result_addr
39     INTEGER, INTENT(IN) :: origin_count, result_count, target_rank,
40     target_count
41     TYPE(MPI_Datatype), INTENT(IN) :: origin_datatype, target_datatype,
42     result_datatype
43     INTEGER(KIND=MPI_ADDRESS_KIND), INTENT(IN) :: target_disp
44     TYPE(MPI_Op), INTENT(IN) :: op
45     TYPE(MPI_Win), INTENT(IN) :: win
46     TYPE(MPI_Request), INTENT(OUT) :: request
47     INTEGER, OPTIONAL, INTENT(OUT) :: ierror
48

```

```

MPI_RGET_ACCUMULATE(ORIGIN_ADDR, ORIGIN_COUNT, ORIGIN_DATATYPE,
                    RESULT_ADDR, RESULT_COUNT, RESULT_DATATYPE, TARGET_RANK,
                    TARGET_DISP, TARGET_COUNT, TARGET_DATATYPE, OP, WIN, REQUEST,
                    IERROR)
<type> ORIGIN_ADDR(*), RESULT_ADDR(*)
INTEGER(KIND=MPI_ADDRESS_KIND) TARGET_DISP
INTEGER ORIGIN_COUNT, ORIGIN_DATATYPE, RESULT_COUNT, RESULT_DATATYPE,
TARGET_RANK, TARGET_COUNT, TARGET_DATATYPE, OP, WIN, REQUEST, IERROR

```

MPI_RGET_ACCUMULATE is similar to MPI_GET_ACCUMULATE (Section 11.3.4), except that it allocates a communication request object and associates it with the request handle (the argument `request`) that can be used to wait or test for completion. The completion of an MPI_RGET_ACCUMULATE operation indicates that the data is available in the result buffer and the origin buffer is free to be updated. It does not indicate that the operation has been completed at the target window.

ticket270.

11.4 Memory Model

The memory semantics of RMA are best understood by using the concept of public and private window copies. We assume that systems have a public memory region that is addressable by all processes (e.g., the shared memory in shared memory machines or the exposed main memory in distributed memory machines). In addition, most machines have fast private buffers (e.g., transparent caches or explicit communication buffers) local to each process where copies of data elements from the main memory can be stored for faster access. Such buffers are either coherent, i.e., all updates to main memory are reflected in all private copies consistently, or non-coherent, i.e., conflicting accesses to main memory need to be synchronized and updated in all private copies explicitly. Coherent systems allow direct updates to remote memory without any participation of the remote side. Non-coherent systems, however, need to call RMA functions in order to reflect updates to the public window in their private memory. Thus, in coherent memory, the public and the private window are identical while they remain logically separate in the non-coherent case. MPI thus differentiates between two memory models called *RMA unified*, if public and private window are logically identical, and *RMA separate*, otherwise.

In the RMA separate model, there is only one instance of each variable in process memory, but a distinct *public* copy of the variable for each window that contains it. A load accesses the instance in process memory (this includes MPI sends). A local store accesses and updates the instance in process memory (this includes MPI receives), but the update may affect other public copies of the same locations. A get on a window accesses the public copy of that window. A put or accumulate on a window accesses and updates the public copy of that window, but the update may affect the private copy of the same locations in process memory, and public copies of other overlapping windows. This is illustrated in Figure 11.1.

ticket284.

In the RMA unified model, public and private copies are identical and updates via put or accumulate calls are observed by load operations without additional RMA calls. A store access to a window is visible to remote get or accumulate calls without additional RMA calls. These stronger semantics of the RMA unified model allow the user to omit some synchronization calls and potentially improve performance.

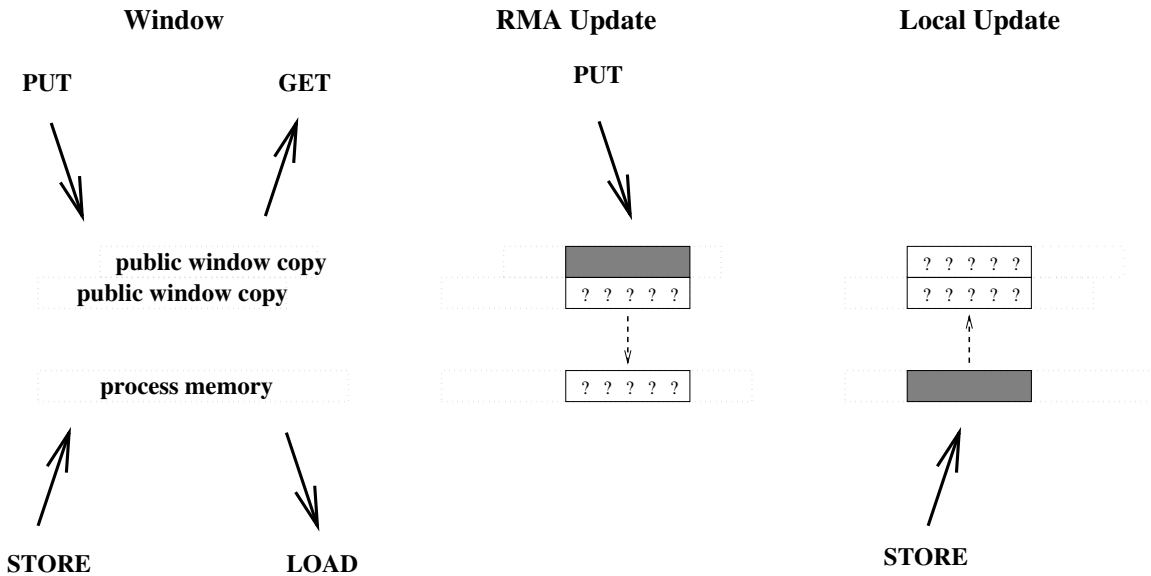

Figure 11.1: Schematic description of [ticket270.]the public/private window operations in the MPI_WIN_SEPARATE memory model for two overlapping windows.

Advice to users. If accesses in the RMA unified model are not synchronized (with locks or flushes, see Section 11.5.3), load and store operations might observe changes to the memory while they are in progress. The order in which data is written is not specified unless further synchronization is used. This might lead to inconsistent views on memory and programs that assume that a transfer is complete by only checking parts of the message are erroneous. (*End of advice to users.*)

The memory model for a particular RMA window can be determined by accessing the attribute MPI_WIN_MODEL. If the memory model is the unified model, the value of this attribute is MPI_WIN_UNIFIED; otherwise, the value is MPI_WIN_SEPARATE.

11.5 Synchronization Calls

RMA communications fall in two categories:

- **active target** communication, where data is moved from the memory of one process to the memory of another, and both are explicitly involved in the communication. This communication pattern is similar to message passing, except that all the data transfer arguments are provided by one process, and the second process only participates in the synchronization.
- **passive target** communication, where data is moved from the memory of one process to the memory of another, and only the origin process is explicitly involved in the transfer. Thus, two origin processes may communicate by accessing the same location in a target window. The process that owns the target window may be distinct from the two communicating processes, in which case it does not participate explicitly in the communication. This communication paradigm is closest to a shared memory model, where shared data can be accessed by all processes, irrespective of location.

RMA communication calls with argument `win` must occur at a process only within an **access epoch** for `win`. Such an epoch starts with an RMA synchronization call on `win`; it proceeds with zero or more RMA communication calls (e.g., `MPI_PUT`, `MPI_GET` or `MPI_ACCUMULATE`) on `win`; it completes with another synchronization call on `win`. This allows users to amortize one synchronization with multiple data transfers and provide implementors more flexibility in the implementation of RMA operations.

Distinct access epochs for `win` at the same process must be disjoint. On the other hand, epochs pertaining to different `win` arguments may overlap. Local operations or other MPI calls may also occur during an epoch.

In active target communication, a target window can be accessed by RMA operations only within an **exposure epoch**. Such an epoch is started and completed by RMA synchronization calls executed by the target process. Distinct exposure epochs at a process on the same window must be disjoint, but such an exposure epoch may overlap with exposure epochs on other windows or with access epochs for the same or other `win` arguments. There is a one-to-one matching between access epochs at origin processes and exposure epochs on target processes: RMA operations issued by an origin process for a target window will access that target window during the same exposure epoch if and only if they were issued during the same access epoch.

In passive target communication the target process does not execute RMA synchronization calls, and there is no concept of an exposure epoch.

MPI provides three synchronization mechanisms:

1. The `MPI_WIN_FENCE` collective synchronization call supports a simple synchronization pattern that is often used in parallel computations: namely a loosely-synchronous model, where global computation phases alternate with global communication phases. This mechanism is most useful for loosely synchronous algorithms where the graph of communicating processes changes very frequently, or where each process communicates with many others.

This call is used for active target communication. An access epoch at an origin process or an exposure epoch at a target process are started and completed by calls to `MPI_WIN_FENCE`. A process can access windows at all processes in the group of `win` during such an access epoch, and the local window can be accessed by all processes in the group of `win` during such an exposure epoch.

2. The four functions `MPI_WIN_START`, `MPI_WIN_COMPLETE`, `MPI_WIN_POST` and `MPI_WIN_WAIT` can be used to restrict synchronization to the minimum: only pairs of communicating processes synchronize, and they do so only when a synchronization is needed to order correctly RMA accesses to a window with respect to local accesses to that same window. This mechanism may be more efficient when each process communicates with few (logical) neighbors, and the communication graph is fixed or changes infrequently.

These calls are used for active target communication. An access epoch is started at the origin process by a call to `MPI_WIN_START` and is terminated by a call to `MPI_WIN_COMPLETE`. The start call has a group argument that specifies the group of target processes for that epoch. An exposure epoch is started at the target process by a call to `MPI_WIN_POST` and is completed by a call to `MPI_WIN_WAIT`. The post call has a group argument that specifies the set of origin processes for that epoch.

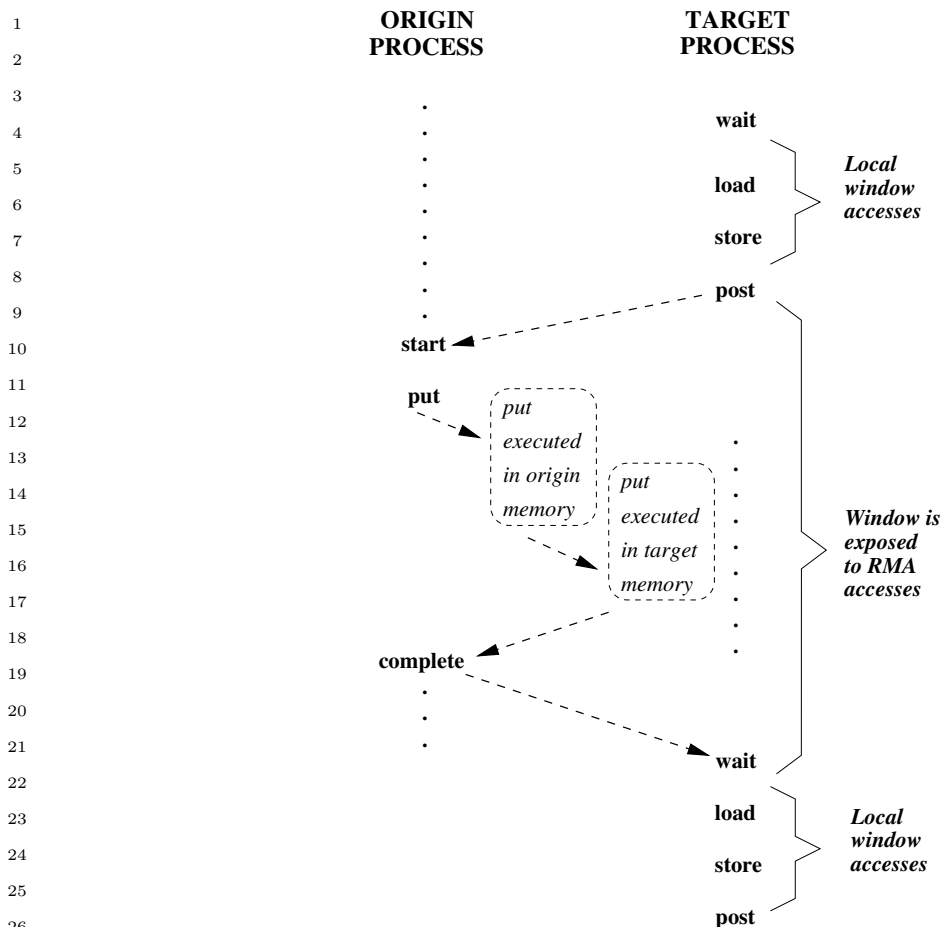

Figure 11.2: Active target communication. Dashed arrows represent synchronizations (ordering of events).

3. [Finally, shared and exclusive locks are provided by the two functions `MPI_WIN_LOCK` and `MPI_WIN_UNLOCK`.] Finally, shared lock access is provided by the functions `MPI_WIN_LOCK`, `MPI_WIN_LOCK_ALL`, `MPI_WIN_UNLOCK`, and `MPI_WIN_UNLOCK_ALL`. `MPI_WIN_LOCK` and `MPI_WIN_UNLOCK` also provide exclusive lock capability. Lock synchronization is useful for MPI applications that emulate a shared memory model via MPI calls; e.g., in a “billboard” model, where processes can, at random times, access or update different parts of the billboard.

These [two]four calls provide passive target communication. An access epoch is started by a call to `MPI_WIN_LOCK` or `MPI_WIN_LOCK_ALL` and terminated by a call to `MPI_WIN_UNLOCK` or `MPI_WIN_UNLOCK_ALL`, respectively. [Only one target window can be accessed during that epoch with `win`.]

Figure 11.2 illustrates the general synchronization pattern for active target communication. The synchronization between `post` and `start` ensures that the `put` call of the origin process does not start until the target process exposes the window (with the `post` call); the target process will expose the window only after preceding local accesses to the window have completed. The synchronization between `complete` and `wait` ensures that the `put` call of the origin process completes before the window is unexposed (with the `wait` call). The

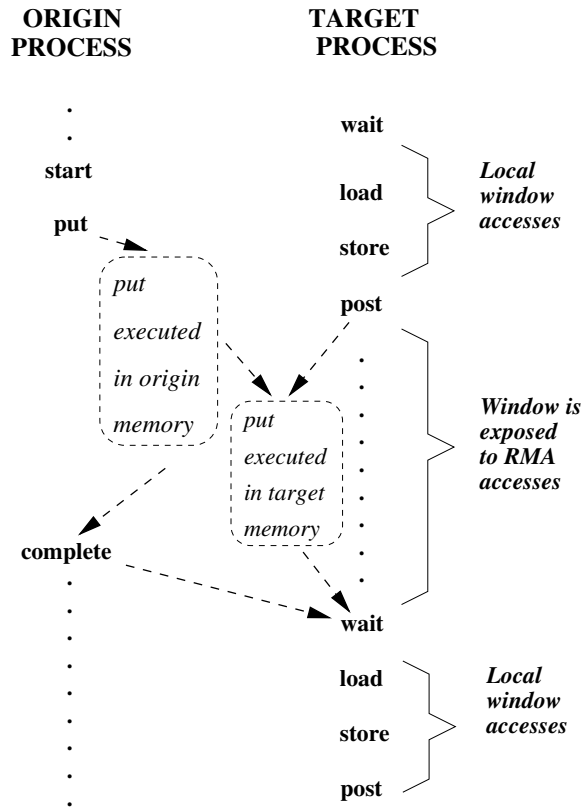

Figure 11.3: Active target communication, with weak synchronization. Dashed arrows represent synchronizations (ordering of events)

target process will execute following local accesses to the target window only after the `wait` returned.

Figure 11.2 shows operations occurring in the natural temporal order implied by the synchronizations: the `post` occurs before the matching `start`, and `complete` occurs before the matching `wait`. However, such **strong** synchronization is more than needed for correct ordering of window accesses. The semantics of MPI calls allow **weak** synchronization, as illustrated in Figure 11.3. The access to the target window is delayed until the window is exposed, after the `post`. However the `start` may complete earlier; the `put` and `complete` may also terminate earlier, if put data is buffered by the implementation. The synchronization calls order correctly window accesses, but do not necessarily synchronize other operations. This weaker synchronization semantic allows for more efficient implementations.

Figure 11.4 illustrates the general synchronization pattern for passive target communication. The first origin process communicates data to the second origin process, through the memory of the target process; the target process is not explicitly involved in the communication. The `lock` and `unlock` calls ensure that the two RMA accesses do not occur concurrently. However, they do *not* ensure that the `put` by origin 1 will precede the `get` by origin 2.

Rationale. RMA does not define fine-grained mutexes in memory (only logical coarse-grained process locks). MPI provides the primitives (`compare and swap`, `accumulate[s]`, `send/[recv]receive`, etc.) needed to implement high-level synchronization operations. (End of rationale.)

1
2
3
4
5
6
7
8
9
10
11
12
13
14
15
16
17
18
19
20
21
22
23
24
25
26
27
28
29
30
31
32
33
34
35
36
37
38
39
40
41
42
43
44
45
46
47
48

ticket270.

ticketxx:5/11

ticketxx:5/11

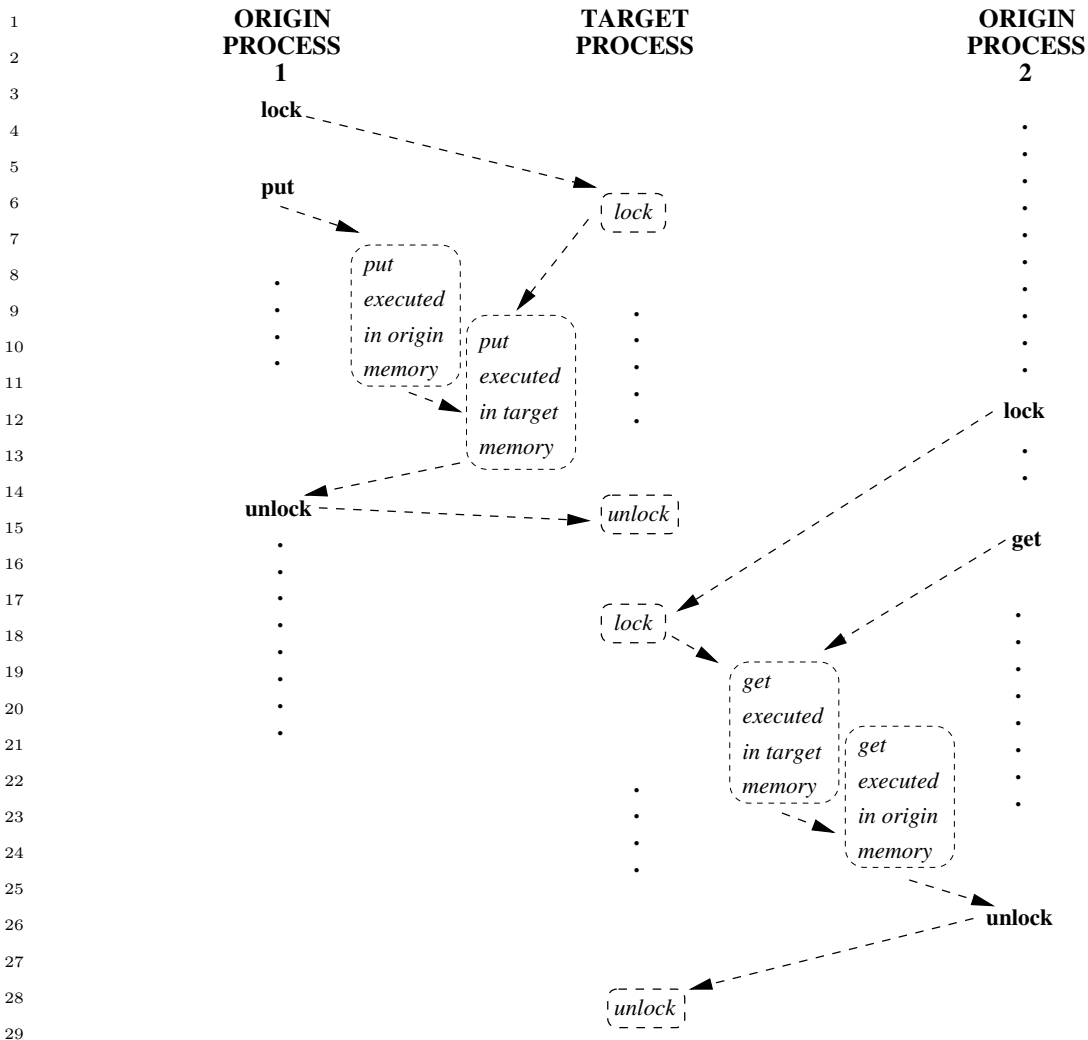

Figure 11.4: Passive target communication. Dashed arrows represent synchronizations (ordering of events).

11.5.1 Fence

`MPI_WIN_FENCE(assert, win)`

IN	assert	program assertion (integer)
IN	win	window object (handle)

`int MPI_Win_fence(int assert, MPI_Win win)`

```
MPI_Win_fence(assert, win, ierror) BIND(C)
    INTEGER, INTENT(IN) :: assert
    TYPE(MPI_Win), INTENT(IN) :: win
    INTEGER, OPTIONAL, INTENT(OUT) :: ierror
```

`MPI_WIN_FENCE(ASSERT, WIN, IERROR)`

ticket-248T.

```

    INTEGER ASSERT, WIN, IERROR
    {void MPI::Win::Fence(int assert) const(binding deprecated, see Section 15.2) }

```

The MPI call `MPI_WIN_FENCE(assert, win)` synchronizes RMA calls on `win`. The call is collective on the group of `win`. All RMA operations on `win` originating at a given process and started before the fence call will complete at that process before the fence call returns. They will be completed at their target before the fence call returns at the target. RMA operations on `win` started by a process after the fence call returns will access their target window only after `MPI_WIN_FENCE` has been called by the target process.

The call completes an RMA access epoch if it was preceded by another fence call and the local process issued RMA communication calls on `win` between these two calls. The call completes an RMA exposure epoch if it was preceded by another fence call and the local window was the target of RMA accesses between these two calls. The call starts an RMA access epoch if it is followed by another fence call and by RMA communication calls issued between these two fence calls. The call starts an exposure epoch if it is followed by another fence call and the local window is the target of RMA accesses between these two fence calls. Thus, the fence call is equivalent to calls to a subset of `post`, `start`, `complete`, `wait`.

A fence call usually entails a barrier synchronization: a process completes a call to `MPI_WIN_FENCE` only after all other processes in the group entered their matching call. However, a call to `MPI_WIN_FENCE` that is known not to end any epoch (in particular, a call with `assert = MPI_MODE_NOPRECEDE`) does not necessarily act as a barrier.

The `assert` argument is used to provide assertions on the context of the call that may be used for various optimizations. This is described in Section 11.5.5. A value of `assert = 0` is always valid.

Advice to users. Calls to `MPI_WIN_FENCE` should both precede and follow calls to `[put, get or accumulate]`RMA communication functions that are synchronized with fence calls. (*End of advice to users.*)

11.5.2 General Active Target Synchronization

```

MPI_WIN_START(group, assert, win)

```

IN	group	group of target processes (handle)
IN	assert	program assertion (integer)
IN	win	window object (handle)

```

int MPI_Win_start(MPI_Group group, int assert, MPI_Win win)

```

```

MPI_Win_start(group, assert, win, ierror) BIND(C)
    TYPE(MPI_Group), INTENT(IN) :: group
    INTEGER, INTENT(IN) :: assert
    TYPE(MPI_Win), INTENT(IN) :: win
    INTEGER, OPTIONAL, INTENT(OUT) :: ierror

```

```

MPI_WIN_START(GROUP, ASSERT, WIN, IERROR)
    INTEGER GROUP, ASSERT, WIN, IERROR

```

```

1 {void MPI::Win::Start(const MPI::Group& group, int assert) const(binding
2     deprecated, see Section 15.2) }
```

3
4 Starts an RMA access epoch for win. RMA calls issued on win during this epoch must
5 access only windows at processes in group. Each process in group must issue a matching
6 call to MPI_WIN_POST. RMA accesses to each target window will be delayed, if necessary,
7 until the target process executed the matching call to MPI_WIN_POST. MPI_WIN_START
8 is allowed to block until the corresponding MPI_WIN_POST calls are executed, but is not
9 required to.

10 The assert argument is used to provide assertions on the context of the call that may
11 be used for various optimizations. This is described in Section 11.5.5. A value of assert =
12 0 is always valid.

```
14 MPI_WIN_COMPLETE(win)
```

```
15     IN           win                window object (handle)
```

```
17 int MPI_Win_complete(MPI_Win win)
```

```
19 MPI_Win_complete(win, ierror) BIND(C)
20     TYPE(MPI_Win), INTENT(IN) :: win
21     INTEGER, OPTIONAL, INTENT(OUT) :: ierror
```

```
23 MPI_WIN_COMPLETE(WIN, IERROR)
24     INTEGER WIN, IERROR
```

```
25 {void MPI::Win::Complete() const(binding deprecated, see Section 15.2) }
```

27 Completes an RMA access epoch on win started by a call to MPI_WIN_START. All
28 RMA communication calls issued on win during this epoch will have completed at the origin
29 when the call returns.

30 MPI_WIN_COMPLETE enforces completion of preceding RMA calls at the origin, but
31 not at the target. A put or accumulate call may not have completed at the target when it
32 has completed at the origin.

33 Consider the sequence of calls in the example below.

35 **Example 11.4**

```
36 MPI_Win_start(group, flag, win);
37 MPI_Put(..., win);
38 MPI_Win_complete(win);
```

40 The call to MPI_WIN_COMPLETE does not return until the put call has completed
41 at the origin; and the target window will be accessed by the put operation only after the
42 call to MPI_WIN_START has matched a call to MPI_WIN_POST by the target process.
43 This still leaves much choice to implementors. The call to MPI_WIN_START can block
44 until the matching call to MPI_WIN_POST occurs at all target processes. One can also
45 have implementations where the call to MPI_WIN_START is nonblocking, but the call to
46 MPI_PUT blocks until the matching call to MPI_WIN_POST occurred; or implementations
47 where the first two calls are nonblocking, but the call to MPI_WIN_COMPLETE blocks
48 until the call to MPI_WIN_POST occurred; or even implementations where all three calls

can complete before any target process called `MPI_WIN_POST` — the data put must be buffered, in this last case, so as to allow the put to complete at the origin ahead of its completion at the target. However, once the call to `MPI_WIN_POST` is issued, the sequence above must complete, without further dependencies.

`MPI_WIN_POST(group, assert, win)`

IN	group	group of origin processes (handle)
IN	assert	program assertion (integer)
IN	win	window object (handle)

`int MPI_Win_post(MPI_Group group, int assert, MPI_Win win)`

`MPI_Win_post(group, assert, win, ierror) BIND(C)`

`TYPE(MPI_Group), INTENT(IN) :: group`

`INTEGER, INTENT(IN) :: assert`

`TYPE(MPI_Win), INTENT(IN) :: win`

`INTEGER, OPTIONAL, INTENT(OUT) :: ierror`

`MPI_WIN_POST(GROUP, ASSERT, WIN, IERROR)`

`INTEGER GROUP, ASSERT, WIN, IERROR`

`{void MPI::Win::Post(const MPI::Group& group, int assert) const`
(binding deprecated, see Section 15.2) }

Starts an RMA exposure epoch for the local window associated with `win`. Only processes in `group` should access the window with RMA calls on `win` during this epoch. Each process in `group` must issue a matching call to `MPI_WIN_START`. `MPI_WIN_POST` does not block.

`MPI_WIN_WAIT(win)`

IN	win	window object (handle)
----	-----	------------------------

`int MPI_Win_wait(MPI_Win win)`

`MPI_Win_wait(win, ierror) BIND(C)`

`TYPE(MPI_Win), INTENT(IN) :: win`

`INTEGER, OPTIONAL, INTENT(OUT) :: ierror`

`MPI_WIN_WAIT(WIN, IERROR)`

`INTEGER WIN, IERROR`

`{void MPI::Win::Wait() const`
(binding deprecated, see Section 15.2) }

Completes an RMA exposure epoch started by a call to `MPI_WIN_POST` on `win`. This call matches calls to `MPI_WIN_COMPLETE(win)` issued by each of the origin processes that were granted access to the window during this epoch. The call to `MPI_WIN_WAIT` will block until all matching calls to `MPI_WIN_COMPLETE` have occurred. This guarantees that all these origin processes have completed their RMA accesses to the local window. When the call returns, all these RMA accesses will have completed at the target window.

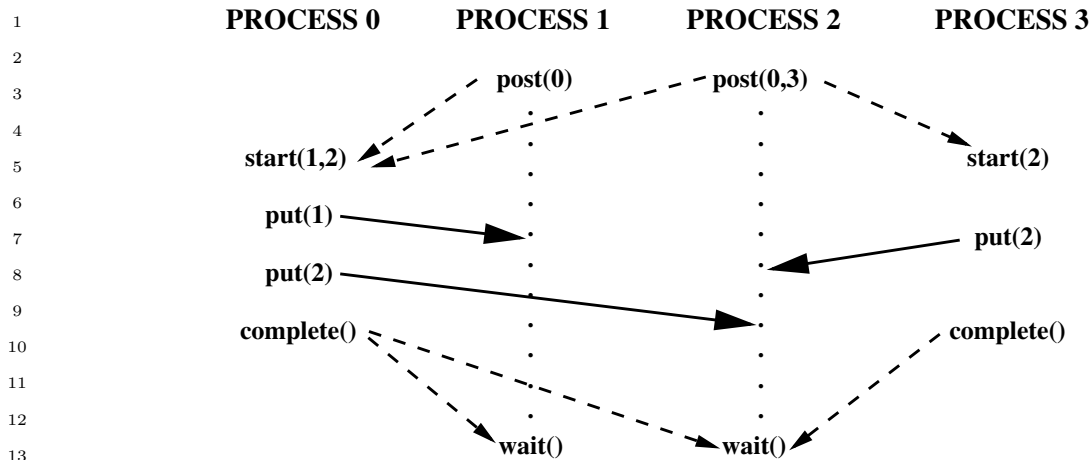

Figure 11.5: Active target communication. Dashed arrows represent synchronizations and solid arrows represent data transfer.

Figure 11.5 illustrates the use of these four functions. Process 0 puts data in the windows of processes 1 and 2 and process 3 puts data in the window of process 2. Each start call lists the ranks of the processes whose windows will be accessed; each post call lists the ranks of the processes that access the local window. The figure illustrates a possible timing for the events, assuming strong synchronization; in a weak synchronization, the start, put or complete calls may occur ahead of the matching post calls.

MPI_WIN_TEST(win, flag)

IN	win	window object (handle)
OUT	flag	success flag (logical)

```
int MPI_Win_test(MPI_Win win, int *flag)
```

```
MPI_Win_test(win, flag, ierror) BIND(C)
  TYPE(MPI_Win), INTENT(IN) :: win
  LOGICAL, INTENT(OUT) :: flag
  INTEGER, OPTIONAL, INTENT(OUT) :: ierror
```

```
MPI_WIN_TEST(WIN, FLAG, IERROR)
  INTEGER WIN, IERROR
  LOGICAL FLAG
```

```
{bool MPI::Win::Test() const(binding deprecated, see Section 15.2) }
```

This is the nonblocking version of MPI_WIN_WAIT. It returns `flag = true` if all accesses to the local window by the group to which it was exposed by the corresponding MPI_WIN_POST call have been completed as signalled by matching MPI_WIN_COMPLETE calls, and `flag = false` otherwise. In the former case MPI_WIN_WAIT would have returned immediately. The effect of return of MPI_WIN_TEST with `flag = true` is the same as the effect of a return of MPI_WIN_WAIT. If `flag = false` is returned, then the call has no visible

effect.

`MPI_WIN_TEST` should be invoked only where `MPI_WIN_WAIT` can be invoked. Once the call has returned `flag = true`, it must not be invoked anew, until the window is posted anew.

Assume that window `win` is associated with a “hidden” communicator `wincomm`, used for communication by the processes of `win`. The rules for matching of post and start calls and for matching complete and wait call can be derived from the rules for matching sends and receives, by considering the following (partial) model implementation.

`MPI_WIN_POST(group,0,win)` initiate a nonblocking send with tag `tag0` to each process in `group`, using `wincomm`. No need to wait for the completion of these sends.

`MPI_WIN_START(group,0,win)` initiate a nonblocking receive with tag `tag0` from each process in `group`, using `wincomm`. An RMA access to a window in target process `i` is delayed until the receive from `i` is completed.

`MPI_WIN_COMPLETE(win)` initiate a nonblocking send with tag `tag1` to each process in the group of the preceding start call. No need to wait for the completion of these sends.

`MPI_WIN_WAIT(win)` initiate a nonblocking receive with tag `tag1` from each process in the group of the preceding post call. Wait for the completion of all receives.

No races can occur in a correct program: each of the sends matches a unique receive, and vice[-] versa.

Rationale. The design for general active target synchronization requires the user to provide complete information on the communication pattern, at each end of a communication link: each origin specifies a list of targets, and each target specifies a list of origins. This provides maximum flexibility (hence, efficiency) for the implementor: each synchronization can be initiated by either side, since each “knows” the identity of the other. This also provides maximum protection from possible races. On the other hand, the design requires more information than RMA needs, in general: in general, it is sufficient for the origin to know the rank of the target, but not vice versa. Users that want more “anonymous” communication will be required to use the fence or lock mechanisms. (*End of rationale.*)

Advice to users. Assume a communication pattern that is represented by a directed graph $G = \langle V, E \rangle$, where $V = \{0, \dots, n - 1\}$ and $ij \in E$ if origin process i accesses the window at target process j . Then each process i issues a call to `MPI_WIN_POST(ingroupi, ...)`, followed by a call to `MPI_WIN_START(outgroupi, ...)`, where $outgroup_i = \{j : ij \in E\}$ and $ingroup_i = \{j : ji \in E\}$. A call is a noop, and can be skipped, if the group argument is empty. After the communications calls, each process that issued a start will issue a complete. Finally, each process that issued a post will issue a wait.

Note that each process may call with a group argument that has different members. (*End of advice to users.*)

ticket270.

11.5.3 Lock

```
MPI_WIN_LOCK(lock_type, rank, assert, win)
```

IN	lock_type	either MPI_LOCK_EXCLUSIVE or MPI_LOCK_SHARED (state)
IN	rank	rank of locked window (non-negative integer)
IN	assert	program assertion (integer)
IN	win	window object (handle)

```
int MPI_Win_lock(int lock_type, int rank, int assert, MPI_Win win)
```

```
MPI_Win_lock(lock_type, rank, assert, win, ierror) BIND(C)
  INTEGER, INTENT(IN) :: lock_type, rank, assert
  TYPE(MPI_Win), INTENT(IN) :: win
  INTEGER, OPTIONAL, INTENT(OUT) :: ierror
```

```
MPI_WIN_LOCK(LOCK_TYPE, RANK, ASSERT, WIN, IERROR)
  INTEGER LOCK_TYPE, RANK, ASSERT, WIN, IERROR
```

```
{void MPI::Win::Lock(int lock_type, int rank, int assert) const(binding
  deprecated, see Section 15.2) }
```

Starts an RMA access epoch. Only the window at the process with rank `rank` can be accessed by RMA operations on `win` during that epoch.

```
MPI_WIN_LOCK_ALL(assert, win)
```

IN	assert	program assertion (integer)
IN	win	window object (handle)

```
int MPI_Win_lock_all(int assert, MPI_Win win)
```

```
MPI_Win_lock_all(assert, win, ierror) BIND(C)
  INTEGER, INTENT(IN) :: assert
  TYPE(MPI_Win), INTENT(IN) :: win
  INTEGER, OPTIONAL, INTENT(OUT) :: ierror
```

```
MPI_WIN_LOCK_ALL(ASSERT, WIN, IERROR)
  INTEGER ASSERT, WIN, IERROR
```

Starts an RMA access epoch to all processes in `win`, with a lock type of `MPI_LOCK_SHARED`. During the epoch, the calling process can access the window memory on all processes in `win` by using RMA operations. A window locked with `MPI_WIN_LOCK_ALL` must be unlocked with `MPI_WIN_UNLOCK_ALL`. This routine is not collective — the `ALL` refers to a lock on all members of the group of the window.

Advice to users. There may be additional overheads associated with using `MPI_WIN_LOCK` and `MPI_WIN_LOCK_ALL` concurrently on the same window. These

overheads could be avoided by specifying the assertion `MPI_MODE_NOCHECK` when possible (see Section 11.5.5). (*End of advice to users.*)

`MPI_WIN_UNLOCK(rank, win)`

IN	rank	rank of window (non-negative integer)
IN	win	window object (handle)

`int MPI_Win_unlock(int rank, MPI_Win win)`

`MPI_Win_unlock(rank, win, ierror) BIND(C)`
`INTEGER, INTENT(IN) :: rank`
`TYPE(MPI_Win), INTENT(IN) :: win`
`INTEGER, OPTIONAL, INTENT(OUT) :: ierror`

`MPI_WIN_UNLOCK(RANK, WIN, IERROR)`
`INTEGER RANK, WIN, IERROR`

`{void MPI::Win::Unlock(int rank) const(binding deprecated, see Section 15.2) }`

Completes an RMA access epoch started by a call to `MPI_WIN_LOCK(...,win)`. RMA operations issued during this period will have completed both at the origin and at the target when the call returns.

`MPI_WIN_UNLOCK_ALL(win)`

IN	win	window object (handle)
----	-----	------------------------

`int MPI_Win_unlock_all(MPI_Win win)`

`MPI_Win_unlock_all(win, ierror) BIND(C)`
`TYPE(MPI_Win), INTENT(IN) :: win`
`INTEGER, OPTIONAL, INTENT(OUT) :: ierror`

`MPI_WIN_UNLOCK_ALL(WIN, IERROR)`
`INTEGER WIN, IERROR`

Completes a shared RMA access epoch started by a call to `MPI_WIN_LOCK_ALL(assert, win)`. RMA operations issued during this epoch will have completed both at the origin and at the target when the call returns.

Locks are used to protect accesses to the locked target window effected by RMA calls issued between the lock and unlock calls, and to protect [local] load/store accesses to a locked local or shared memory window executed between the lock and unlock call. Accesses that are protected by an exclusive lock will not be concurrent at the window site with other accesses to the same window that are lock protected. Accesses that are protected by a shared lock will not be concurrent at the window site with accesses protected by an exclusive lock to the same window.

It is erroneous to have a window locked and exposed (in an exposure epoch) concurrently. [I.e.]For example, a process may not call `MPI_WIN_LOCK` to lock a target window

1 if the target process has called `MPI_WIN_POST` and has not yet called `MPI_WIN_WAIT`; it
 2 is erroneous to call `MPI_WIN_POST` while the local window is locked.

3
 4 *Rationale.* An alternative is to require MPI to enforce mutual exclusion between
 5 exposure epochs and locking periods. But this would entail additional overheads
 6 when locks or active target synchronization do not interact in support of those rare
 7 interactions between the two mechanisms. The programming style that we encourage
 8 here is that a set of windows is used with only one synchronization mechanism at
 9 a time, with shifts from one mechanism to another being rare and involving global
 10 synchronization. (*End of rationale.*)

11
 12 *Advice to users.* Users need to use explicit synchronization code in order to enforce
 13 mutual exclusion between locking periods and exposure epochs on a window. (*End of*
 14 *advice to users.*)

15
 16 Implementors may restrict the use of RMA communication that is synchronized by
 17 lock calls to windows in memory allocated by `MPI_ALLOC_MEM` (Section 8.2, page 355),
 18 `MPI_WIN_ALLOCATE` (Section 11.2.2, page 427), or attached with `MPI_WIN_ATTACH`
 19 (Section 11.2.4, page 431). Locks can be used portably only in such memory.

20
 21 *Rationale.* The implementation of passive target communication when memory is not
 22 shared [requires]may require an asynchronous software agent. Such an agent can be
 23 implemented more easily, and can achieve better performance, if restricted to specially
 24 allocated memory. It can be avoided altogether if shared memory is used. It seems
 25 natural to impose restrictions that allows one to use shared memory for [3-rd]third
 26 party communication in shared memory machines.

27
 28 The downside of this decision is that passive target communication cannot be used
 29 without taking advantage of nonstandard Fortran features: namely, the availability
 30 of C-like pointers; these are not supported by some Fortran compilers[(g77 and Win-
 31 dows/NT compilers, at the time of writing)]. [Also, passive target communication
 32 cannot be portably targeted to COMMON blocks, or other statically declared Fortran
 33 arrays.] (*End of rationale.*)

34 Consider the sequence of calls in the example below.

35 Example 11.5

```
36 MPI_Win_lock(MPI_LOCK_EXCLUSIVE, rank, assert, win);
37 MPI_Put(..., rank, ..., win);
38 MPI_Win_unlock(rank, win);
39
```

40
 41 The call to `MPI_WIN_UNLOCK` will not return until the put transfer has completed at
 42 the origin and at the target. This still leaves much freedom to implementors. The call to
 43 `MPI_WIN_LOCK` may block until an exclusive lock on the window is acquired; or, the call
 44 `MPI_WIN_LOCK` may not block, while the call to `MPI_PUT` blocks until a lock is acquired;
 45 or, the first two calls may not block, while `MPI_WIN_UNLOCK` blocks until a lock is acquired
 46 — the update of the target window is then postponed until the call to `MPI_WIN_UNLOCK`
 47 occurs. However, if the call to `MPI_WIN_LOCK` is used to lock a local window, then the call
 48 must block until the lock is acquired, since the lock may protect local load/store accesses
 to the window issued after the lock call returns.

11.5.4 Flush and Sync

All flush and sync functions can be called only within lock-unlock or lockall-unlockall epochs.

`MPI_WIN_FLUSH(rank, win)`

IN rank rank of target window (non-negative integer)
 IN win window object (handle)

`int MPI_Win_flush(int rank, MPI_Win win)`

`MPI_Win_flush(rank, win, ierror) BIND(C)`
 INTEGER, INTENT(IN) :: rank
 TYPE(MPI_Win), INTENT(IN) :: win
 INTEGER, OPTIONAL, INTENT(OUT) :: ierror

`MPI_WIN_FLUSH(RANK, WIN, IERROR)`
 INTEGER RANK, WIN, IERROR

`MPI_WIN_FLUSH` completes all outstanding RMA operations initiated by the calling process to the target rank on the specified window. The operations are completed both at the origin and at the target. Flush completes locally in the sense used in this document, meaning that the call must return without requiring the target process to call any MPI routine.

`MPI_WIN_FLUSH_ALL(win)`

IN win window object (handle)

`int MPI_Win_flush_all(MPI_Win win)`

`MPI_Win_flush_all(win, ierror) BIND(C)`
 TYPE(MPI_Win), INTENT(IN) :: win
 INTEGER, OPTIONAL, INTENT(OUT) :: ierror

`MPI_WIN_FLUSH_ALL(WIN, IERROR)`
 INTEGER WIN, IERROR

All RMA operations issued by the calling process to any target on the specified window prior to this call and in the specified window will have completed both at the origin and at the target when this call returns. `MPI_WIN_FLUSH_ALL` completes locally in the sense used in this document, meaning that the call must return without requiring the target processes to call any MPI routine.

`MPI_WIN_FLUSH_LOCAL(rank, win)`

IN rank rank of target window (non-negative integer)
 IN win window object (handle)

1 `int MPI_Win_flush_local(int rank, MPI_Win win)`
 ticket-248T. 2 `MPI_Win_flush_local(rank, win, ierror) BIND(C)`
 3 `INTEGER, INTENT(IN) :: rank`
 4 `TYPE(MPI_Win), INTENT(IN) :: win`
 5 `INTEGER, OPTIONAL, INTENT(OUT) :: ierror`
 6
 7 `MPI_WIN_FLUSH_LOCAL(RANK, WIN, IERROR)`
 8 `INTEGER RANK, WIN, IERROR`
 9

10 Locally completes at the origin all outstanding RMA operations initiated by the calling
 ticket270. 11 process to the target process specified by rank on the specified window. For example, after
 12 this routine completes, the user may reuse any buffers provided to put, get, or accumulate
 13 operations. `MPI_WIN_FLUSH_LOCAL` completes locally in the sense used in this document,
 14 meaning that the call must return without requiring the target processes to call any MPI
 15 routine.

16
 17 `MPI_WIN_FLUSH_LOCAL_ALL(win)`
 18 `IN win window object (handle)`
 19

20
 ticket-248T. 21 `int MPI_Win_flush_local_all(MPI_Win win)`
 22 `MPI_Win_flush_local_all(win, ierror) BIND(C)`
 23 `TYPE(MPI_Win), INTENT(IN) :: win`
 24 `INTEGER, OPTIONAL, INTENT(OUT) :: ierror`
 25
 26 `MPI_WIN_FLUSH_LOCAL_ALL(WIN, IERROR)`
 27 `INTEGER WIN, IERROR`
 28

29 All RMA operations issued to any target prior to this call in this window will have
 30 completed at the origin when `MPI_WIN_FLUSH_LOCAL_ALL` returns.
 31 `MPI_WIN_FLUSH_LOCAL_ALL` completes locally in the sense used in this document, mean-
 32 ing that the call must return without requiring the target processes to call any MPI routine.
 33

34 `MPI_WIN_SYNC(win)`
 35 `IN win window object (handle)`
 36

37
 ticket-248T. 38 `int MPI_Win_sync(MPI_Win win)`
 39 `MPI_Win_sync(win, ierror) BIND(C)`
 40 `TYPE(MPI_Win), INTENT(IN) :: win`
 41 `INTEGER, OPTIONAL, INTENT(OUT) :: ierror`
 42
 43 `MPI_WIN_SYNC(WIN, IERROR)`
 44 `INTEGER WIN, IERROR`
 45

46 ticket270. The call `MPI_WIN_SYNC` synchronizes the private and public window copy of win.
 47 For the purposes of synchronizing the private and public window, `MPI_WIN_SYNC` has the
 48 effect of ending and reopening an access and exposure epoch on the window (note that it

does not actually end an epoch or complete any pending [MPI]MPI RMA operations).

11.5.5 Assertions

The `assert` argument in the calls `MPI_WIN_POST`, `MPI_WIN_START`, `MPI_WIN_FENCE`[and], `MPI_WIN_LOCK`, and `MPI_WIN_LOCK_ALL` is used to provide assertions on the context of the call that may be used to optimize performance. The `assert` argument does not change program semantics if it provides correct information on the program — it is erroneous to provide[s] incorrect information. Users may always provide `assert = 0` to indicate a general case[,] where no guarantees are made.

Advice to users. Many implementations may not take advantage of the information in `assert`; some of the information is relevant only for noncoherent[,] shared memory machines. Users should consult their implementation manual to find which information is useful on each system. On the other hand, applications that provide correct assertions whenever applicable are portable and will take advantage of assertion specific optimizations[,] whenever available. (*End of advice to users.*)

Advice to implementors. Implementations can always ignore the `assert` argument. Implementors should document which `assert` values are significant on their implementation. (*End of advice to implementors.*)

`assert` is the bit-vector OR of zero or more of the following integer constants: `MPI_MODE_NOCHECK`, `MPI_MODE_NOSTORE`, `MPI_MODE_NOPUT`, `MPI_MODE_NOPRECEDE` and `MPI_MODE_NOSUCCEED`. The significant options are listed below[,] for each call.

Advice to users. C/C++ users can use bit vector or (|) to combine these constants; Fortran 90 users can use the bit-vector `IOR` intrinsic. Fortran 77 users can use (non-portably) bit vector `IOR` on systems that support it. Alternatively, Fortran users can portably use integer addition to OR the constants (each constant should appear at most once in the addition!). (*End of advice to users.*)

MPI_WIN_START:

`MPI_MODE_NOCHECK` — the matching calls to `MPI_WIN_POST` have already completed on all target processes when the call to `MPI_WIN_START` is made. The `nocheck` option can be specified in a start call if and only if it is specified in each matching post call. This is similar to the optimization of “ready-send” that may save a handshake when the handshake is implicit in the code. (However, ready-send is matched by a regular receive, whereas both start and post must specify the `nocheck` option.)

MPI_WIN_POST:

`MPI_MODE_NOCHECK` — the matching calls to `MPI_WIN_START` have not yet occurred on any origin processes when the call to `MPI_WIN_POST` is made. The `nocheck` option can be specified by a post call if and only if it is specified by each matching start call.

1 MPI_MODE_NOSTORE — the local window was not updated by [local] stores (or local
 2 get or receive calls) since last synchronization. This may avoid the need for cache
 3 synchronization at the post call. ticket284.

4 MPI_MODE_NOPUT — the local window will not be updated by put or accumulate
 5 calls after the post call, until the ensuing (wait) synchronization. This may avoid
 6 the need for cache synchronization at the wait call.
 7

8 MPI_WIN_FENCE:

9
 ticket284. 10 MPI_MODE_NOSTORE — the local window was not updated by [local] stores (or local
 11 get or receive calls) since last synchronization.

12 MPI_MODE_NOPUT — the local window will not be updated by put or accumulate
 13 calls after the fence call, until the ensuing (fence) synchronization.

14 MPI_MODE_NOPRECEDE — the fence does not complete any sequence of locally issued
 15 RMA calls. If this assertion is given by any process in the window group, then it
 16 must be given by all processes in the group. ticket270.

17 **[MPI_MODE_NOSUCCEED]** **MPI_MODE_NOSUCCEED** — the fence does not start
 18 any sequence of locally issued RMA calls. If the assertion is given by any process
 19 in the window group, then it must be given by all processes in the group.
 20

21 MPI_WIN_LOCK, **MPI_WIN_LOCK_ALL**:

22
 23 MPI_MODE_NOCHECK — no other process holds, or will attempt to acquire a con-
 24 flicting lock, while the caller holds the window lock. This is useful when mutual
 25 exclusion is achieved by other means, but the coherence operations that may be
 26 attached to the lock and unlock calls are still required.
 27

28 *Advice to users.* Note that the nostore and noprecede flags provide information on
 29 what happened *before* the call; the noput and nosucceed flags provide information on
 30 what will happen *after* the call. (*End of advice to users.*)
 31

32 11.5.6 Miscellaneous Clarifications

33 Once an RMA routine completes, it is safe to free any opaque objects passed as argument
 34 to that routine. For example, the `datatype` argument of a `MPI_PUT` call can be freed as
 35 soon as the call returns, even though the communication may not be complete.
 36

37 As in message-passing, datatypes must be committed before they can be used in RMA
 ticket270. 38 communication.
 39

40 **[[Moved: Section on Examples]]**

41 11.6 Error Handling

42 11.6.1 Error Handlers

43
 ticket270. 44 Errors occurring during calls to **[MPI_WIN_CREATE(...,comm,...)]** routines that create MPI
 45 windows (e.g., `MPI_WIN_CREATE(...,comm,...)`) cause the error handler currently associ-
 46 ated with `comm` to be invoked. All other RMA calls have an input `win` argument. When an
 47 error occurs during such a call, the error handler currently associated with `win` is invoked.
 48

The default error handler associated with win is MPI_ERRORS_ARE_FATAL. Users may change this default by explicitly associating a new error handler with win (see Section 8.3, page 358).

11.6.2 Error Classes

The [following] error classes for one-sided communication are defined in Table 11.2. RMA routines may (and almost certainly will) use other MPI error classes, such as MPI_ERR_OP or MPI_ERR_RANK.

MPI_ERR_WIN	invalid win argument	
MPI_ERR_BASE	invalid base argument	
MPI_ERR_SIZE	invalid size argument	
MPI_ERR_DISP	invalid disp argument	
MPI_ERR_LOCKTYPE	invalid locktype argument	
MPI_ERR_ASSERT	invalid assert argument	
MPI_ERR_RMA_CONFLICT	conflicting accesses to window	
MPI_ERR_RMA_SYNC	[ticket270.][wrong]invalid synchronization of RMA calls	
[ticket270.]MPI_ERR_RMA_RANGE	[ticket270.]target memory is not part of the window (in the case of a window created with MPI_WIN_CREATE_DYNAMIC, target memory is not attached)	
[ticket270.]MPI_ERR_RMA_ATTACH	[ticket270.]memory cannot be attached (e.g., because of resource exhaustion)	
[ticket284.]MPI_ERR_RMA_SHARED	[ticket284.]memory cannot be shared (e.g., some process in the group of the specified communicator cannot expose shared memory)	
[ticket284.]MPI_ERR_RMA_WRONG_FLAVOR	[ticket284.]passed window has the wrong flavor for the called function	

Table 11.2: Error classes in one-sided communication routines

11.7 Semantics and Correctness

[The semantics of RMA operations is best understood by assuming that the system maintains a separate *public* copy of each window, in addition to the original location in process memory (the *private* window copy). There is only one instance of each variable in process memory, but a distinct *public* copy of the variable for each window that contains it. A load accesses the instance in process memory (this includes MPI sends). A store accesses and updates the instance in process memory (this includes MPI receives), but the update may affect other public copies of the same locations. A get on a window accesses the public copy of that window. A put or accumulate on a window accesses and updates the public copy of that window, but the update may affect the private copy of the same locations in process memory, and public copies of other overlapping windows. This is illustrated in Figure 11.1.]

The following rules specify the latest time at which an operation must complete at the origin or the target. The update performed by a get call in the origin process memory is visible when the get operation is complete at the origin (or earlier); the update performed by a put or accumulate call in the public copy of the target window is visible when the put or accumulate has completed at the target (or earlier). The rules also specify the latest time at which an update of one window copy becomes visible in another overlapping copy.

1. An RMA operation is completed at the origin by the ensuing call to `MPI_WIN_COMPLETE`, `MPI_WIN_FENCE` [or `MPI_WIN_UNLOCK`], `MPI_WIN_FLUSH`, `MPI_WIN_FLUSH_ALL`, `MPI_WIN_FLUSH_LOCAL`, `MPI_WIN_FLUSH_LOCAL_ALL`, `MPI_WIN_UNLOCK`, or `MPI_WIN_UNLOCK_ALL` that synchronizes this access at the origin.
2. If an RMA operation is completed at the origin by a call to `MPI_WIN_FENCE` then the operation is completed at the target by the matching call to `MPI_WIN_FENCE` by the target process.
3. If an RMA operation is completed at the origin by a call to `MPI_WIN_COMPLETE` then the operation is completed at the target by the matching call to `MPI_WIN_WAIT` by the target process.
4. If an RMA operation is completed at the origin by a call to `MPI_WIN_UNLOCK`, `MPI_WIN_UNLOCK_ALL`, `MPI_WIN_FLUSH(rank=target)`, or `MPI_WIN_FLUSH_ALL`, then the operation is completed at the target by that same call [to `MPI_WIN_UNLOCK`].
5. An update of a location in a private window copy in process memory becomes visible in the public window copy at latest when an ensuing call to `MPI_WIN_POST`, `MPI_WIN_FENCE`, [or `MPI_WIN_UNLOCK`] `MPI_WIN_UNLOCK`, `MPI_WIN_UNLOCK_ALL`, or `MPI_WIN_SYNC` is executed on that window by the window owner. In the RMA unified memory model, an update of a location in a private window in process memory becomes visible without additional RMA calls.
6. An update by a put or accumulate call to a public window copy becomes visible in the private copy in process memory at latest when an ensuing call to `MPI_WIN_WAIT`, `MPI_WIN_FENCE`, [or `MPI_WIN_LOCK`] `MPI_WIN_LOCK`, `MPI_WIN_LOCK_ALL`, or `MPI_WIN_SYNC` is executed on that window by the window owner. In the RMA unified memory model, an update by a put or accumulate call to a public window copy becomes visible in the private copy in process memory without additional RMA calls.

The `MPI_WIN_FENCE` or `MPI_WIN_WAIT` call that completes the transfer from public copy to private copy (6) is the same call that completes the put or accumulate operation in the window copy (2, 3). If a put or accumulate access was synchronized with a lock, then the update of the public window copy is complete as soon as the updating process executed `MPI_WIN_UNLOCK` or `MPI_WIN_UNLOCK_ALL`. [On the other hand] In the RMA separate memory model, the update of private copy in the process memory may be delayed until the target process executes a synchronization call on that window (6). Thus, updates to process memory can always be delayed in the RMA separate memory model until the process executes a suitable synchronization call, while they have to complete in the RMA unified

ticket270.

model without additional synchronization calls. [Updates to a public window copy can also be delayed until the window owner executes a synchronization call, if fences or post-start-complete-wait synchronization is used.]If fence or post-start-complete-wait synchronization is used, updates to a public window copy can be delayed in both memory models until the window owner executes a synchronization call. [Only when lock synchronization is used does it become necessary to update the public window copy, even if the window owner does not execute any related synchronization call.]When passive-target synchronization (lock/unlock or even flush) is used, it is necessary to update the public window copy in the RMA separate model, or the private window copy in the RMA unified model, even if the window owner does not execute any related synchronization call.

The rules above also define, by implication, when an update to a public window copy becomes visible in another overlapping public window copy. Consider, for example, two overlapping windows, win1 and win2. A call to `MPI_WIN_FENCE(0, win1)` by the window owner makes visible in the process memory previous updates to window win1 by remote processes. A subsequent call to `MPI_WIN_FENCE(0, win2)` makes these updates visible in the public copy of win2.

The behavior of some MPI RMA operations may be *undefined* in some situations. For example, the result of several origin processes performing concurrent `MPI_PUT` operations to the same target location is undefined. In addition, the result of a single origin process performing multiple `MPI_PUT` operation to the same target location within the same access epoch is also undefined. The result at the target may have all of the data from one of the `MPI_PUT` operations (the “last” one, in some sense), or bytes from some of each of the operations, or something else. In MPI-2, such operations were *erroneous*. That meant that an MPI implementation was permitted to signal an MPI exception. Thus, user programs or tools that used MPI RMA could not portably permit such operations, even if the application code could function correctly with such an undefined result. In MPI-3, these operations are not erroneous, but do not have a defined behavior.

Rationale. As discussed in [6], requiring operations such as overlapping puts to be erroneous makes it [very]difficult to use MPI RMA to implement programming models—such as Unified Parallel C (UPC) or SHMEM—that permit these operations. Further, while MPI-2 defined these operations as erroneous, the MPI Forum is unaware of any implementation that enforces this rule, as it would require significant overhead. Thus, relaxing this condition does not impact existing implementations or applications. (*End of rationale.*)

Advice to implementors. Overlapping accesses are undefined. However, to assist users in debugging code, implementations may wish to provide a mode in which such operations are detected and reported to the user. Note, however, that in MPI-3, such operations must not generate an MPI exception. (*End of advice to implementors.*)

A [correct program]program with well-defined outcome in the `MPI_WIN_SEPARATE` memory model must obey the following rules.

1. A location in a window must not be accessed [locally]with load/store operations once an update to that location has started, until the update becomes visible in the private window copy in process memory.
2. A location in a window must not be accessed as a target of an RMA operation once an update to that location has started, until the update becomes visible in the public

1 window copy. There is one exception to this rule, in the case where the same variable is
 ticket270. 2 updated by two concurrent accumulates [that use the same operation,]with the same
 ticket270. 3 predefined datatype, on the same window. Additional restrictions on the operation
 4 apply, see the info key `accumulate_ops` in Section 11.2.1.

- 5
 ticket284. 6 3. A put or accumulate must not access a target window once a [local]load/store update
 ticket270. 7 or a put or accumulate update to another (overlapping) target window [have]has
 8 started on a location in the target window, until the update becomes visible in the
 ticket284. 9 public copy of the window. Conversely, a [local update in]store to process memory to
 10 a location in a window must not start once a put or accumulate update to that target
 11 window has started, until the put or accumulate update becomes visible in process
 12 memory. In both cases, the restriction applies to operations even if they access disjoint
 13 locations in the window.

ticket270. 14 [A program is erroneous if it violates these rules.]

15
 16 *Rationale.* The last constraint on correct RMA accesses may seem unduly restric-
 17 tive, as it forbids concurrent accesses to nonoverlapping locations in a window. The
 18 reason for this constraint is that, on some architectures, explicit coherence restoring
 19 operations may be needed at synchronization points. A different operation may be
 ticket284. 20 needed for locations that were [locally] updated by stores and for locations that were
 21 remotely updated by put or accumulate operations. Without this constraint, the MPI
 22 library will have to track precisely which locations in a window were updated by a
 23 put or accumulate call. The additional overhead of maintaining such information is
 24 considered prohibitive. (*End of rationale.*)

25
 ticket270. 26 Note that `MPI_WIN_SYNC` may be used within a passive target epoch to synchronize
 ticket270. 27 the private and public window copies (that is, updates to one are made visible to the other).

28 In the `MPI_WIN_UNIFIED` memory model, the rules are much simpler because the public
 29 and private windows are the same. However, there are restrictions to avoid concurrent
 30 access to the same memory locations by different processes. The rules that a program with
 31 a well-defined outcome must obey in this case are:

- 32
 ticket284. 33 1. A location in a window must not be accessed [locally]with load/store operations once
 34 an update to that location has started, until the update is complete, subject to the
 35 following special case.
 ticket284. 36
 ticket284. 37 2. [Locally accessing (but not updating)]Accessing a location in the window [with a load
 38 operation]that is also the target of a remote update is valid (not erroneous) but the
 39 precise result will depend on the behavior of the implementation. Updates from a
 40 remote process will appear in the memory of the target, but there are no atomicity or
 41 ordering guarantees if more than one byte is updated. Updates are stable in the sense
 42 that once data appears in memory of the target, the data remains until replaced by
 43 another update. This permits polling on a location for a change from zero to non-zero
 44 or for a particular value, but not polling and comparing the relative magnitude of
 45 values. Users are cautioned that polling on one memory location and then accessing a
 46 different memory location has defined behavior only if the other rules given here and
 47 in this chapter are followed.
 48

Advice to users. Some compiler optimizations can result in code that maintains the sequential semantics of the program, but violates this rule by introducing temporary values into locations in memory. Most compilers only apply such transformations under very high levels of optimization and users should be aware that such aggressive optimization may produce unexpected results. (*End of advice to users.*)

3. [Locally u]Updating a location in the window with a store operation that is also the target of a remote read (but not update) is valid (not erroneous) but the precise result will depend on the behavior of the implementation. [Updates from the local process]Store updates will appear in memory, but there are no atomicity or ordering guarantees if more than one byte is updated. Updates are stable in the sense that once data appears in memory, the data remains until replaced by another update. This permits [the local process] to update memory [in its local window]with store operations without requiring a lock/unlock or other RMA synchronization epoch. Users are cautioned that remote accesses to a window that is updated by the local process has defined behavior only if the other rules given here and in this chapter are followed.
4. A location in a window must not be accessed as a target of an RMA operation once an update to that location has started until the update completes at the target. There is one exception to this rule: in the case where the same variable is updated by two concurrent accumulates with the same predefined datatype on the same window. Additional restrictions on the operation apply; see the info key `accumulate_ops` in Section 11.2.1.
5. A put or accumulate must not access a target window once a [local update]store operation or a put or accumulate update to another (overlapping) target window has started on the same location in the target window until the update completes at the target window. Conversely, a [local update]store operation in process memory to a location in a window must not start once a put or accumulate update to the same location in that target window has started until the put or accumulate update completes at the target.

Note that `MPI_WIN_FLUSH` and `MPI_WIN_FLUSH_ALL` may be used within a passive target epoch to complete RMA operations at the target process.

A program that violates these rules has undefined behavior.

Advice to users. A user can write correct programs by following the following rules:

fence: During each period between fence calls, each window is either updated by put or accumulate calls, or updated by [local] stores, but not both. Locations updated by put or accumulate calls should not be accessed during the same period (with the exception of concurrent updates to the same location by accumulate calls). Locations accessed by get calls should not be updated during the same period.

post-start-complete-wait: A window should not be updated [locally]with store operations while being posted, if it is being updated by put or accumulate calls. Locations updated by put or accumulate calls should not be accessed while the window is posted (with the exception of concurrent updates to the same location

by accumulate calls). Locations accessed by get calls should not be updated while the window is posted.

With the post-start synchronization, the target process can tell the origin process that its window is now ready for RMA access; with the complete-wait synchronization, the origin process can tell the target process that it has finished its RMA accesses to the window.

lock: Updates to the window are protected by exclusive locks if they may conflict. Nonconflicting accesses (such as read-only accesses or accumulate accesses) are protected by shared locks, both for `[local]load/store` accesses and for RMA accesses.

changing window or synchronization mode: One can change synchronization mode, or change the window used to access a location that belongs to two overlapping windows, when the process memory and the window copy are guaranteed to have the same values. This is true after a local call to `MPI_WIN_FENCE`, if RMA accesses to the window are synchronized with fences; after a local call to `MPI_WIN_WAIT`, if the accesses are synchronized with post-start-complete-wait; after the call at the origin (local or remote) to `MPI_WIN_UNLOCK` or `MPI_WIN_UNLOCK_ALL` if the accesses are synchronized with locks.

In addition, a process should not access the local buffer of a get operation until the operation is complete, and should not update the local buffer of a put or accumulate operation until that operation is complete.

The RMA synchronization operations define when updates are guaranteed to become visible in public and private windows. Updates may become visible earlier, but such behavior is implementation dependent. (*End of advice to users.*)

The semantics are illustrated by the following examples:

Example 11.6 [Rule 5:] The following example demonstrates updating a memory location inside a window for the separate memory model, according to Rule 5. The `MPI_WIN_LOCK` and `MPI_WIN_UNLOCK` calls around the store to X in process B are necessary to ensure consistency between the public and private copies of the window.

```

Process A:
MPI_Barrier

MPI_Win_lock(EXCLUSIVE,B)
MPI_Get(X) /* ok, read from public window */
MPI_Win_unlock(B)

Process B:
window location X

MPI_Win_lock(EXCLUSIVE,B)
store X /* local update to private copy of B */
MPI_Win_unlock(B)
/* now visible in public window copy */

MPI_Barrier

```

Example 11.7 In the RMA unified model, although the public and private copies of the windows are synchronized, caution must be used when combining [local] load/stores and multi-process synchronization. Although the following example appears correct, the compiler or hardware may delay the store to X after the barrier, possibly resulting in the MPI_GET returning the incorrect value of X.

```

Process A:                Process B:
                           window location X

                           store X /* update to private&public copy of B */
MPI_Barrier                MPI_Barrier
MPI_Win_lock_all
MPI_Get(X) /* ok, read from window */
MPI_Win_flush_local(B)
/* read value in X */
MPI_Win_unlock_all

```

MPI_BARRIER provides process synchronization, but not [local] memory synchronization. The example could potentially be made safe through the use of compiler and hardware specific notations to ensure the store to X occurs before process B enters the MPI_BARRIER. The use of one-sided synchronization calls, as shown in Example 11.6, also ensures the correct result.

Example 11.8 [Rule 6:]The following example demonstrates the reading of a memory location updated by a remote process (Rule 6) in the RMA separate memory model. Although the MPI_WIN_UNLOCK on process A and the MPI_BARRIER ensure that the public copy on process B reflects the updated value of X, the call to MPI_WIN_LOCK by process B is necessary to synchronize the private copy with the public copy.

```

Process A:                Process B:
                           window location X

MPI_Win_lock(EXCLUSIVE,B)
MPI_Put(X) /* update to public window */
MPI_Win_unlock(B)

MPI_Barrier                MPI_Barrier

                           MPI_Win_lock(EXCLUSIVE,B)
                           /* now visible in private copy of B */
                           load X
                           MPI_Win_unlock(B)

```

Note that in this example, the barrier is not critical to the semantic correctness. The use of exclusive locks guarantees a remote process will not modify the public copy after MPI_WIN_LOCK synchronizes the private and public copies. A polling implementation looking for changes in X on process B would be semantically correct. The barrier is required to ensure that process A performs the put operation before process B performs the load of X.

Example 11.9 Similar to Example 11.7, the following example is unsafe even in the unified model, because the load of X can not be guaranteed to occur after the MPI_BARRIER. While Process B does not need to explicitly synchronize the public and private copies through MPI_WIN_LOCK as the MPI_PUT will update both the public and private copies of the window, the scheduling of the load could result in old values of X being returned. Compiler and hardware specific notations could ensure the load occurs after the data is updated, or explicit one-sided synchronization calls can be used to ensure the proper result.

```

9      Process A:                Process B:
10                                     window location X
11      MPI_Win_lock_all
12      MPI_Put(X) /* update to window */
13      MPI_Win_flush(B)
14
15      MPI_Barrier                MPI_Barrier
16                                     load X
17      MPI_Win_unlock_all

```

Example 11.10 [The rules do *not* guarantee that process A in the following sequence will see the value of X as updated by the local store by B before the lock.] The following example further clarifies Rule 5. MPI_WIN_LOCK and MPI_WIN_LOCK_ALL do *not* update the public copy of a window with changes to the private copy. Therefore, there is no guarantee that process A in the following sequence will see the value of X as updated by the local store by process B before the lock.

```

26     Process A:                Process B:
27                                     window location X
28
29                                     store X /* update to private copy of B */
30                                     MPI_Win_lock(SHARED,B)
31      MPI_Barrier                MPI_Barrier
32
33      MPI_Win_lock(SHARED,B)
34      MPI_Get(X) /* X may be the X before the store */
35      MPI_Win_unlock(B)
36
37                                     MPI_Win_unlock(B)
38                                     /* update on X now visible in public window */

```

The addition of an MPI_WIN_SYNC before the call to MPI_BARRIER by process B would guarantee process A would see the updated value of X, as the public copy of the window would be explicitly synchronized with the private copy.

Example 11.11 [In the following sequence] Similar to the previous example, Rule 5 can have unexpected implications for general active target synchronization with the RMA separate memory model. It is *not* guaranteed that process B reads the value of X as per the local update by process A, because neither MPI_WIN_WAIT nor MPI_WIN_COMPLETE calls by process A ensure visibility in the public window copy.

```

Process A:                Process B:
window location X
window location Y

store Y
MPI_Win_post(A,B) /* Y visible in public window */
MPI_Win_start(A)        MPI_Win_start(A)

store X /* update to private window */

MPI_Win_complete        MPI_Win_complete
MPI_Win_wait
/* update on X may not yet visible in public window */

MPI_Barrier                MPI_Barrier

                             MPI_Win_lock(EXCLUSIVE,A)
                             MPI_Get(X) /* may return an obsolete value */
                             MPI_Get(Y)
                             MPI_Win_unlock(A)

```

[it is *not* guaranteed that process B reads the value of X as per the local update by process A, because neither MPI_WIN_WAIT nor MPI_WIN_COMPLETE calls by process A ensure visibility in the public window copy.] To allow process B to read the value of X stored by A the local store must be replaced by a local MPI_PUT that updates the public window copy. Note that by this replacement X may become visible in the private copy [in]of process [memory of]A only after the MPI_WIN_WAIT call in process A. The update to Y made before the MPI_WIN_POST call is visible in the public window after the MPI_WIN_POST call and therefore [correctly gotten by process B]process B will read the proper value of Y. The MPI_GET(Y) call could be moved to the epoch started by the MPI_WIN_START operation, and process B would still get the value stored by process A.

Example 11.12 [Finally, in the following sequence]The following example demonstrates the interaction of general active target synchronization with local read operations with the RMA separate memory model. Rules 5 and 6 do *not* guarantee that the private copy of X at process B has been updated before the load takes place.

```

Process A:                Process B:
                             window location X

MPI_Win_lock(EXCLUSIVE,B)
MPI_Put(X) /* update to public window */
MPI_Win_unlock(B)

MPI_Barrier                MPI_Barrier

                             MPI_Win_post(B)
                             MPI_Win_start(B)

```

```

1          load X /* access to private window */
2              /* may return an obsolete value */
3
4          MPI_Win_complete
5          MPI_Win_wait
ticket270. 6

```

[rules (5,6) do *not* guarantee that the private copy of X at B has been updated before the load takes place.] To ensure that the value put by process A is read, the local load must be replaced with a local MPI_GET operation, or must be placed after the call to MPI_WIN_WAIT.

11.7.1 Atomicity

The outcome of concurrent accumulate[ticket270.][s] operations to the same location[ticket270.][,] with the same [ticket270.][operation and] predefined datatype[ticket270.][,] is as if the accumulates [ticket270.][where]were done at that location in some serial order. [ticket270.][Additional restrictions on the operation apply, see the info key accumulate_ops in Section 11.2.1. [ticket270.][On the other hand, if two locations are both updated by two accumulate calls, then the updates may occur in reverse order at the two locations]Concurrent accumulate operations with different origin and target pairs are not ordered. Thus, there is no guarantee that the entire call to [ticket270.][MPI_ACCUMULATE]an accumulate operation is executed atomically. The effect of this lack of atomicity is limited: The previous correctness conditions imply that a location updated by a call to [ticket270.][MPI_ACCUMULATE,]an accumulate operation cannot be accessed by [ticket270.][a load or an RMA call other than accumulate[ticket270.][,] until the [ticket270.][MPI_ACCUMULATE call]accumulate operation has completed (at the target). Different interleavings can lead to different results only to the extent that computer arithmetics are not truly associative or commutative. [ticket270.][The outcome of accumulate operations with overlapping types of different sizes or target displacements is undefined.

11.7.2 Ordering

Accumulate calls enable element-wise atomic read and write to remote memory locations. MPI specifies ordering between accumulate operations from one process to the same (or overlapping) memory locations at another process on a per-datatype granularity. The default ordering is strict ordering, which guarantees that overlapping updates from the same source to a remote location are committed in program order and that reads (e.g., with MPI_GET_ACCUMULATE) and writes (e.g., with MPI_ACCUMULATE) are executed and committed in program order. Ordering only applies to operations originating at the same origin that access overlapping target memory regions. MPI does not provide any guarantees for accesses or updates from different origins to overlapping target memory regions.

The default strict ordering may incur a significant performance penalty. MPI specifies the info key accumulate_ordering to allow relaxation of the ordering semantics when specified to any window creation function. The values for this key are as follows. If set to none, then no ordering will be guaranteed for accumulate calls. This was the behavior for RMA in MPI-2 but is *not* the default in MPI-3. The key can be set to a comma-separated list of required access orderings at the target. Allowed values in the comma-separated list are rar, war, raw, and waw for read-after-read, write-after-read, read-after-write, and write-after-write ordering, respectively. These indicate whether operations of the specified type complete in

the order they were issued. For example, `raw` means that any writes must complete at the target before any reads. These ordering requirements apply only to operations issued by the same origin process and targeting the same target process. [Note that `rar`, read-after-read, is included for completeness, as ordering is only important if an update (write) may be made.] The default value for `accumulate_ordering` is `rar,raw,war,waw`, which implies that writes complete at the target in the order in which they were issued, reads complete at the target before any writes that are issued after the reads, and writes complete at the target before any reads that are issued after the writes. Any subset of these four orderings can be specified. For example, if only read-after-read and write-after-write ordering is required, then the value of the `accumulate_ordering` key could be set to `rar,waw`. The order of values is not significant.

Note that the above ordering semantics apply only to accumulate operations, not puts and gets. Puts and gets within an epoch are unordered.

11.7.3 Progress

One-sided communication has the same progress requirements as point-to-point communication: once a communication is enabled[, then] it is guaranteed to complete. RMA calls must have local semantics, except when required for synchronization with other RMA calls.

There is some fuzziness in the definition of the time when a RMA communication becomes enabled. This fuzziness provides to the implementor more flexibility than with point-to-point communication. Access to a target window becomes enabled once the corresponding synchronization (such as `MPI_WIN_FENCE` or `MPI_WIN_POST`) has executed. On the origin process, an RMA communication may become enabled as soon as the corresponding put, get or accumulate call has executed, or as late as when the ensuing synchronization call is issued. Once the communication is enabled both at the origin and at the target, the communication must complete.

Consider the code fragment in Example 11.4, on page 462. Some of the calls may block if the target window is not posted. However, if the target window is posted, then the code fragment must complete. The data transfer may start as soon as the put call occurs, but may be delayed until the ensuing complete call occurs.

Consider the code fragment in Example 11.5, on page 468. Some of the calls may block if another process holds a conflicting lock. However, if no conflicting lock is held, then the code fragment must complete.

Consider the code illustrated in Figure 11.6. Each process updates the window of the other process using a put operation, then accesses its own window. The post calls are nonblocking, and should complete. Once the post calls occur, RMA access to the windows is enabled, so that each process should complete the sequence of calls start-put-complete. Once these are done, the wait calls should complete at both processes. Thus, this communication should not deadlock, irrespective of the amount of data transferred.

Assume, in the last example, that the order of the post and start calls is reversed, at each process. Then, the code may deadlock, as each process may block on the start call, waiting for the matching post to occur. Similarly, the program will deadlock, if the order of the complete and wait calls is reversed, at each process.

The following two examples illustrate the fact that the synchronization between complete and wait is not symmetric: the wait call blocks until the complete executes, but not vice[-] versa. Consider the code illustrated in Figure 11.7. This code will deadlock: the wait of process 1 blocks until process 0 calls complete, and the receive of process 0 blocks until

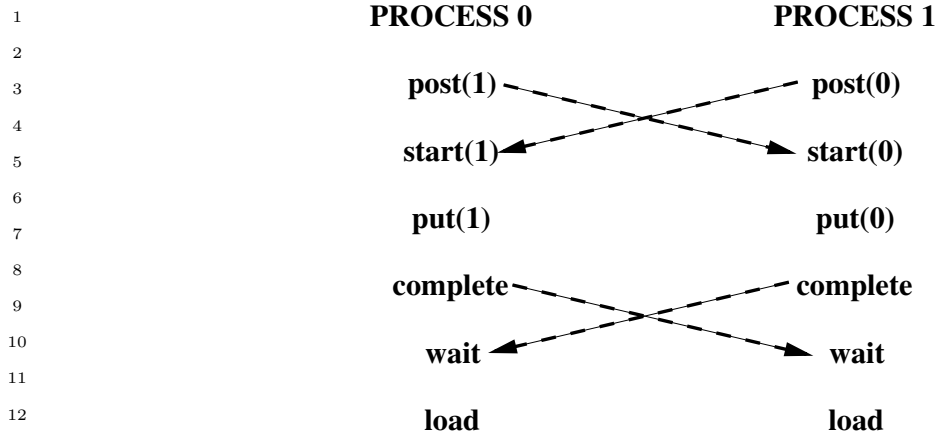

Figure 11.6: Symmetric communication

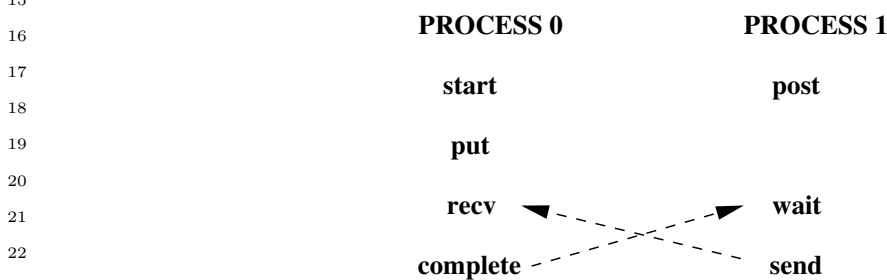

Figure 11.7: Deadlock situation

24
25
26
27
28
29
30

process 1 calls send. Consider, on the other hand, the code illustrated in Figure 11.8. This code will not deadlock. Once process 1 calls post, then the sequence start, put, complete on process 0 can proceed to completion. Process 0 will reach the send call, allowing the receive call of process 1 to complete.

31
32
33
34
35
36
37

Rationale. MPI implementations must guarantee that a process makes progress on all enabled communications it participates in, while blocked on an MPI call. This is true for send-receive communication and applies to RMA communication as well. Thus, in the example in Figure 11.8, the put and complete calls of process 0 should complete while process 1 is blocked on the receive call. This may require the involvement of process 1, e.g., to transfer the data put, while it is blocked on the receive call.

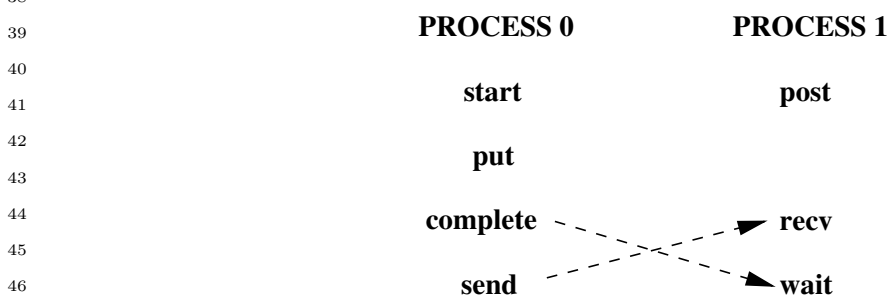

Figure 11.8: No deadlock

A similar issue is whether such progress must occur while a process is busy computing, or blocked in a non-MPI call. Suppose that in the last example the send-receive pair is replaced by a write-to-socket/read-from-socket pair. Then MPI does not specify whether deadlock is avoided. Suppose that the blocking receive of process 1 is replaced by a very long compute loop. Then, according to one interpretation of the MPI standard, process 0 must return from the complete call after a bounded delay, even if process 1 does not reach any MPI call in this period of time. According to another interpretation, the complete call may block until process 1 reaches the wait call, or reaches another MPI call. The qualitative behavior is the same, under both interpretations, unless a process is caught in an infinite compute loop, in which case the difference may not matter. However, the quantitative expectations are different. Different MPI implementations reflect these different interpretations. While this ambiguity is unfortunate, it does not seem to affect many real codes. The MPI [f]Forum decided not to decide which interpretation of the standard is the correct one, since the issue is very contentious, and a decision would have much impact on implementors but less impact on users. (*End of rationale.*)

11.7.4 Registers and Compiler Optimizations

Advice to users. All the material in this section is an advice to users. (*End of advice to users.*)

A coherence problem exists between variables kept in registers and the memory value of these variables. An RMA call may access a variable in memory (or cache), while the up-to-date value of this variable is in register. A get will not return the latest variable value, and a put may be overwritten when the register is stored back in memory. **Note that these issues are unrelated to the RMA memory model; that is, these issues apply even if the memory model is MPI_WIN_UNIFIED.**

The problem is illustrated by the following code:

Source of Process 1	Source of Process 2	Executed in Process 2
bbbb = 777	buff = 999	reg_A:=999
call MPI_WIN_FENCE	call MPI_WIN_FENCE	
call MPI_PUT(bbbb into buff of process 2)		stop appl. thread
		buff:=777 in PUT handler
		continue appl. thread
call MPI_WIN_FENCE	call MPI_WIN_FENCE	
	ccc = buff	ccc:=reg_A

In this example, variable `buff` is allocated in the register `reg_A` and therefore `ccc` will have the old value of `buff` and not the new value 777.

This problem, which also afflicts in some cases send/receive communication, is discussed more at length in Section 16.2.16.

[MPI implementations will avoid this problem for standard conforming C programs.] Programs written in C avoid this problem, because of the semantics of C. Many Fortran compilers will avoid this problem, without disabling compiler optimizations. However, in order to avoid register coherence problems in a completely portable manner, users should restrict their use of RMA windows to variables stored in [COMMON blocks, or to variables that were

declared `VOLATILE` [(while `VOLATILE` is not a standard Fortran declaration, it is supported by many Fortran compilers)] (but this attribute may inhibit optimization of any code containing the RMA window). [Details]Further details and an additional solution are discussed in Section 16.2.16, “A Problem with Register Optimization,” on page 681. See also[,] “Problems Due to Data Copying and Sequence Association,” on page 675, for additional Fortran [problems]issues.]modules or `COMMON` blocks. To prevent problems with the argument copying and register optimization done by Fortran compilers, please note the hints in Sections 16.2.10-16.2.20, especially in Sections 16.2.12 and 16.2.13 on pages 675-678 about “Problems Due to Data Copying and Sequence Association with Subscript Triplets” and “Vector Subscripts”, and in Sections 16.2.16 to 16.2.19 on pages 681 to 692 about “Optimization Problems”, “Code Movements and Register Optimization”, “Temporary Data Movements” and “Permanent Data Movements”. Sections “Solutions” to “`VOLATILE`” on pages 684-689 discuss several solutions for the problem in this example.

ticket270.

11.8 Examples

[This section was moved from earlier in the chapter. Changes and additions to this section are marked in the same way as changes and additions in other parts of this chapter.]

Example 11.13 The following example shows a generic loosely synchronous, iterative code, using fence synchronization. The window at each process consists of array `A`, which contains the origin and target buffers of the put calls.

```
...
while(!converged(A)){
    update(A);
    MPI_Win_fence(MPI_MODE_NOPRECEDE, win);
    for(i=0; i < toneighbors; i++)
        MPI_Put(&frombuf[i], 1, fromtype[i], toneighbor[i],
                todisp[i], 1, totype[i], win);
    MPI_Win_fence((MPI_MODE_NOSTORE | MPI_MODE_NOSUCCEED), win);
}
```

The same code could be written with `get`[,] rather than `put`. Note that, during the communication phase, each window is concurrently read (as origin buffer of puts) and written (as target buffer of puts). This is OK, provided that there is no overlap between the target buffer of a put and another communication buffer.

Example 11.14 Same generic example, with more computation/communication overlap. We assume that the update phase is broken in two subphases: the first, where the “boundary,” which is involved in communication, is updated, and the second, where the “core,” which neither use nor provide communicated data, is updated.

```
...
while(!converged(A)){
    update_boundary(A);
    MPI_Win_fence((MPI_MODE_NOPUT | MPI_MODE_NOPRECEDE), win);
    for(i=0; i < fromneighbors; i++)
        MPI_Get(&tobuf[i], 1, totype[i], fromneighbor[i],
```

```

        fromdisp[i], 1, fromtype[i], win);
    update_core(A);
    MPI_Win_fence(MPI_MODE_NOSUCCEED, win);
}

```

The get communication can be concurrent with the core update, since they do not access the same locations, and the local update of the origin buffer by the get call can be concurrent with the local update of the core by the `update_core` call. In order to get similar overlap with put communication we would need to use separate windows for the core and for the boundary. This is required because we do not allow local stores to be concurrent with puts on the same, or on overlapping, windows.

Example 11.15 Same code as in Example 11.13, rewritten using post-start-complete-wait.

```

...
while(!converged(A)){
    update(A);
    MPI_Win_post(fromgroup, 0, win);
    MPI_Win_start(togroup, 0, win);
    for(i=0; i < toneighbors; i++)
        MPI_Put(&frombuf[i], 1, fromtype[i], toneighbor[i],
                todisp[i], 1, totype[i], win);
    MPI_Win_complete(win);
    MPI_Win_wait(win);
}

```

Example 11.16 Same example, with split phases, as in Example 11.14.

```

...
while(!converged(A)){
    update_boundary(A);
    MPI_Win_post(togroup, MPI_MODE_NOPUT, win);
    MPI_Win_start(fromgroup, 0, win);
    for(i=0; i < fromneighbors; i++)
        MPI_Get(&tobuf[i], 1, totype[i], fromneighbor[i],
                fromdisp[i], 1, fromtype[i], win);
    update_core(A);
    MPI_Win_complete(win);
    MPI_Win_wait(win);
}

```

Example 11.17 A checkerboard, or double buffer communication pattern, that allows more computation/communication overlap. Array `A0` is updated using values of array `A1`, and vice versa. We assume that communication is symmetric: if process A gets data from process B, then process B gets data from process A. Window `wini` consists of array `Ai`.

```

1  ...
2  if (!converged(A0,A1))
3      MPI_Win_post(neighbors, (MPI_MODE_NOCHECK | MPI_MODE_NOPUT), win0);
4  MPI_Barrier(comm0);
5  /* the barrier is needed because the start call inside the
6  loop uses the nocheck option */
7  while(!converged(A0, A1)){
8      /* communication on A0 and computation on A1 */
9      update2(A1, A0); /* local update of A1 that depends on A0 (and A1) */
10     MPI_Win_start(neighbors, MPI_MODE_NOCHECK, win0);
11     for(i=0; i < neighbors; i++)
12         MPI_Get(&tobuf0[i], 1, totype0[i], neighbor[i],
13              fromdisp0[i], 1, fromtype0[i], win0);
14     update1(A1); /* local update of A1 that is
15                 concurrent with communication that updates A0 */
16     MPI_Win_post(neighbors, (MPI_MODE_NOCHECK | MPI_MODE_NOPUT), win1);
17     MPI_Win_complete(win0);
18     MPI_Win_wait(win0);
19
20     /* communication on A1 and computation on A0 */
21     update2(A0, A1); /* local update of A0 that depends on A1 (and A0)*/
22     MPI_Win_start(neighbors, MPI_MODE_NOCHECK, win1);
23     for(i=0; i < neighbors; i++)
24         MPI_Get(&tobuf1[i], 1, totype1[i], neighbor[i],
25              fromdisp1[i], 1, fromtype1[i], win1);
26     update1(A0); /* local update of A0 that depends on A0 only,
27                 concurrent with communication that updates A1 */
28     if (!converged(A0,A1))
29         MPI_Win_post(neighbors, (MPI_MODE_NOCHECK | MPI_MODE_NOPUT), win0);
30     MPI_Win_complete(win1);
31     MPI_Win_wait(win1);
32 }

```

A process posts the local window associated with `win0` before it completes RMA accesses to the remote windows associated with `win1`. When the `wait(win1)` call returns, then all neighbors of the calling process have posted the windows associated with `win0`. Conversely, when the `wait(win0)` call returns, then all neighbors of the calling process have posted the windows associated with `win1`. Therefore, the `nocheck` option can be used with the calls to `MPI_WIN_START`.

Put calls can be used, instead of get calls, if the area of array `A0` (resp. `A1`) used by the `update(A1, A0)` (resp. `update(A0, A1)`) call is disjoint from the area modified by the RMA communication. On some systems, a put call may be more efficient than a get call, as it requires information exchange only in one direction.

In the next several examples, for conciseness, the expression

```
z = MPI_Get_accumulate(...)
```

means to perform an `MPI_GET_ACCUMULATE` with the result buffer (given by `result_addr` in the description of `MPI_GET_ACCUMULATE`) on the left side of the assignment; in this case, `z`. This format is also used with `MPI_COMPARE_AND_SWAP`.

Example 11.18 The following example implements a naive, non-scalable counting semaphore. The example demonstrates the use of `MPI_WIN_SYNC` to manipulate the public copy of `X`, as well as `MPI_WIN_FLUSH` to complete operations without ending the access epoch opened with `MPI_WIN_LOCK_ALL`. To avoid the rules regarding synchronization of the public and private copies of windows, `MPI_ACCUMULATE` and `MPI_GET_ACCUMULATE` are used to write to or read from the local public copy.

<pre> Process A: MPI_Win_lock_all window location X X=2 MPI_Win_sync MPI_Barrier MPI_Accumulate(X, MPI_SUM, -1) stack variable z do z = MPI_Get_accumulate(X, MPI_NO_OP, 0) MPI_Win_flush(A) while(z!=0) MPI_Win_unlock_all </pre>	<pre> Process B: MPI_Win_lock_all MPI_Barrier MPI_Accumulate(X, MPI_SUM, -1) stack variable z do z = MPI_Get_accumulate(X, MPI_NO_OP, 0) MPI_Win_flush(A) while(z!=0) MPI_Win_unlock_all </pre>
---	---

ticket270.

Example 11.19 Implementing a critical region between two processes (Peterson's algorithm). Despite their appearance in the following example, `MPI_WIN_LOCK_ALL` and `MPI_WIN_UNLOCK_ALL` are not collective calls, but it is frequently useful to start shared access epochs to all processes from all other processes in a window. Once the access epochs are established, accumulate communication operations and flush and sync synchronization operations can be used to read from or write to the public copy of the window.

<pre> Process A: window location X window location T MPI_Win_lock_all X=1 MPI_Win_sync MPI_Barrier MPI_Accumulate(T, MPI_REPLACE, 1) stack variables t,y t=1 y=MPI_Get_accumulate(Y, MPI_NO_OP, 0) while(y==1 && t==1) do y=MPI_Get_accumulate(Y, MPI_NO_OP, 0) </pre>	<pre> Process B: window location Y MPI_Win_lock_all Y=1 MPI_Win_sync MPI_Barrier MPI_Accumulate(T, MPI_REPLACE, 0) stack variable t,x t=0 x=MPI_Get_accumulate(X, MPI_NO_OP, 0) while(x==1 && t==0) do x=MPI_Get_accumulate(X, MPI_NO_OP, 0) </pre>
---	--

```

1      t=MPI_Get_accumulate(T,          t=MPI_Get_accumulate(T,
2          MPI_NO_OP, 0)                MPI_NO_OP, 0)
3      MPI_Win_flush_all                MPI_Win_flush(A)
4  done                                done
5  // critical region                   // critical region
6  MPI_Accumulate(X, MPI_REPLACE, 0)    MPI_Accumulate(Y, MPI_REPLACE, 0)
7  MPI_Win_unlock_all                  MPI_Win_unlock_all

```

Example 11.20 Implementing a critical region between multiple processes with compare and swap. The call to `MPI_WIN_SYNC` is necessary on Process A after local initialization of A to guarantee the public copy has been updated with the initialization value found in the private copy. It would also be valid to call `MPI_ACCUMULATE` with `MPI_REPLACE` to directly initialize the public copy. A call to `MPI_WIN_FLUSH` would be necessary to assure A in the public copy of Process A had been updated before the barrier.

```

16  Process A:                          Process B...:
17  MPI_Win_lock_all                    MPI_Win_lock_all
18  atomic location A
19  A=0
20  MPI_Win_sync
21  MPI_Barrier                          MPI_Barrier
22  stack variable r=1                  stack variable r=1
23  while(r != 0) do                    while(r != 0) do
24      r = MPI_Compare_and_swap(A, 0, 1)  r = MPI_Compare_and_swap(A, 0, 1)
25      MPI_Win_flush(A)                  MPI_Win_flush(A)
26  done                                done
27  // critical region                   // critical region
28  r = MPI_Compare_and_swap(A, 1, 0)    r = MPI_Compare_and_swap(A, 1, 0)
29  MPI_Win_unlock_all                  MPI_Win_unlock_all

```

Example 11.21 The following example shows how request-based operations can be used to overlap communication with computation. Each process fetches, processes, and writes the result for `NSTEPS` chunks of data. Instead of a single buffer, `M` local buffers are used to allow up to `M` communication operations to overlap with computation.

```

36  int          i, j;
37  MPI_Win      win;
38  MPI_Request  put_req[M] = { MPI_REQUEST_NULL };
39  MPI_Request  get_req;
40  double      **baseptr;
41  double      data[M][N];
42
43  MPI_Win_allocate(NSTEPS*N*sizeof(double), sizeof(double), MPI_INFO_NULL,
44      MPI_COMM_WORLD, baseptr, &win);
45
46  MPI_Win_lock_all(0, win);
47
48  for (i = 0; i < NSTEPS; i++) {

```

```

if (i<M)
    j=i;
else
    MPI_Waitany(M, put_req, &j, MPI_STATUS_IGNORE);

MPI_Rget(data[j], N, MPI_DOUBLE, target, i*N, N, MPI_DOUBLE, win,
        &get_req);
MPI_Wait(&get_req, MPI_STATUS_IGNORE);
compute(i, data[j], ...);
MPI_Rput(data[j], N, MPI_DOUBLE, target, i*N, N, MPI_DOUBLE, win,
        &put_req[j]);
}

MPI_Waitall(M, put_req, MPI_STATUSES_IGNORE);
MPI_Win_unlock_all(win);

```

1
2
3
4
5
6
7
8
9
10
11
12
13
14
15
16
17
18
19
20
21
22
23
24
25
26
27
28
29
30
31
32
33
34
35
36
37
38
39
40
41
42
43
44
45
46
47
48

ticket270.

Example 11.22

The following example constructs a distributed shared linked list using dynamic windows. Initially process 0 creates the head of the list, attaches it to the window, and broadcasts the pointer to all processes. All processes then concurrently append N new elements to the list. When a process attempts to attach its element to the tail of the list it may discover that its tail pointer is stale and it must chase ahead to the new tail before the element can be attached. This example requires some modification to work in an environment where the length of a pointer is different on different processes.

ticketxx:5/11

ticketxx:5/11

```

...
#define NUM_ELEMS 10

/* Linked list pointer */
typedef struct {
    MPI_Aint disp;
    int rank;
} llist_ptr_t;

/* Linked list element */
typedef struct {
    llist_ptr_t next;
    int value;
} llist_elem_t;

const llist_ptr_t nil = { -1, (MPI_Aint) MPI_BOTTOM };

/* List of locally allocated list elements. */
static llist_elem_t **my_elems = NULL;
static int my_elems_size = 0;
static int my_elems_count = 0;

```

```

1  /* Allocate a new shared linked list element */
2  MPI_Aint alloc_elem(int value, MPI_Win win) {
3      MPI_Aint disp;
4      llist_elem_t *elem_ptr;
5
6      /* Allocate the new element and register it with the window */
7      MPI_Alloc_mem(sizeof(llist_elem_t), MPI_INFO_NULL, &elem_ptr);
8      elem_ptr->value = value;
9      elem_ptr->next = nil;
10     MPI_Win_attach(win, elem_ptr, sizeof(llist_elem_t));
11
12     /* Add the element to the list of local elements so we can free
13        it later. */
14     if (my_elems_size == my_elems_count) {
15         my_elems_size += 100;
16         my_elems = realloc(my_elems, my_elems_size);
17     }
18     my_elems[my_elems_count] = elem_ptr;
19     my_elems_count++;
20
21     MPI_Get_address(elem_ptr, &disp);
22     return disp;
23 }
24
25 int main(int argc, char **argv) {
26     int          procid, nproc, i;
27     MPI_Win      llist_win;
28     llist_ptr_t  head_ptr, tail_ptr;
29
30     MPI_Init(&argc, &argv);
31
32     MPI_Comm_rank(MPI_COMM_WORLD, &procid);
33     MPI_Comm_size(MPI_COMM_WORLD, &nproc);
34
35     MPI_Win_create_dynamic(MPI_INFO_NULL, MPI_COMM_WORLD, &llist_win);
36
37     /* Process 0 creates the head node */
38     if (procid == 0)
39         head_ptr.disp = alloc_elem(-1, llist_win);
40
41     /* Broadcast the head pointer to everyone */
42     head_ptr.rank = 0;
43     MPI_Bcast(&head_ptr.disp, 1, MPI_AINT, 0, MPI_COMM_WORLD);
44     tail_ptr = head_ptr;
45
46     /* Lock the window for shared access to all targets */
47     MPI_Win_lock_all(0, llist_win);
48

```

```

/* All processes concurrently append NUM_ELEMS elements to the list */
for (i = 0; i < NUM_ELEMS; i++) {
    llist_ptr_t new_elem_ptr;
    int success;

    /* Create a new list element and attach it to the window */
    new_elem_ptr.rank = procid;
    new_elem_ptr.disp = alloc_elem(procid, llist_win);

    /* Append the new node to the list. This might take multiple
       attempts if others have already appended and our tail pointer
       is stale. */
    do {
        llist_ptr_t next_tail_ptr = nil;

        MPI_Compare_and_swap((void*) &new_elem_ptr.rank, (void*) &nil.rank,
                              (void*)&next_tail_ptr.rank, MPI_INT, tail_ptr.rank,
                              (MPI_Aint) &(((llist_elem_t*)tail_ptr.disp)->next.rank),
                              llist_win);

        MPI_Win_flush(tail_ptr.rank, llist_win);
        success = (next_tail_ptr.rank == nil.rank);

        if (success) {
            MPI_Accumulate(&new_elem_ptr.disp, 1, MPI_AINT, tail_ptr.rank,
                          (MPI_Aint) &(((llist_elem_t*)tail_ptr.disp)->next.disp), 1,
                          MPI_AINT, MPI_REPLACE, llist_win);

            MPI_Win_flush(tail_ptr.rank, llist_win);
            tail_ptr = new_elem_ptr;
        } else {
            /* Tail pointer is stale, fetch the displacement. May take
               multiple tries if it is being updated. */
            do {
                MPI_Get_accumulate( NULL, 0, MPI_AINT, &next_tail_ptr.disp,
                                    1, MPI_AINT, tail_ptr.rank,
                                    (MPI_Aint) &(((llist_elem_t*)tail_ptr.disp)->next.disp),
                                    1, MPI_AINT, MPI_NO_OP, llist_win);

                MPI_Win_flush(tail_ptr.rank, llist_win);
            } while (next_tail_ptr.disp == nil.disp);
            tail_ptr = next_tail_ptr;
        }
    } while (!success);
}

MPI_Win_unlock_all(llist_win);

```

```
1     MPI_Barrier( MPI_COMM_WORLD );
2
3     /* Free all the elements in the list */
4     for ( ; my_elems_count > 0; my_elems_count--) {
5         MPI_Win_detach(l1list_win,my_elems[my_elems_count-1]);
6         MPI_Free_mem(my_elems[my_elems_count-1]);
7     }
8     MPI_Win_free(&l1list_win);
9     ...
10
11
12
13
14
15
16
17
18
19
20
21
22
23
24
25
26
27
28
29
30
31
32
33
34
35
36
37
38
39
40
41
42
43
44
45
46
47
48
```

1
2
3
4
5
6
7
8
9
10
11
12
13
14
15
16
17
18
19
20
21
22
23
24
25
26
27
28
29
30
31
32
33
34
35
36
37
38
39
40
41
42
43
44
45
46
47
48

Chapter 12

External Interfaces

12.1 Introduction

This chapter begins with calls used to create **generalized requests**, which allow users to create new nonblocking operations with an interface similar to what is present in MPI. This can be used to layer new functionality on top of MPI. Next, Section 12.3 deals with setting the information found in `status`. [This is] This functionality is needed for generalized requests.

ticket0.

The chapter continues, in Section 12.4, with a discussion of how threads are to be handled in MPI. Although thread compliance is not required, the standard specifies how threads are to work if they are provided.

12.2 Generalized Requests

The goal of generalized requests is to allow users to define new nonblocking operations. Such an outstanding nonblocking operation is represented by a (generalized) request. A fundamental property of nonblocking operations is that progress toward the completion of this operation occurs asynchronously, i.e., concurrently with normal program execution. Typically, this requires execution of code concurrently with the execution of the user code, e.g., in a separate thread or in a signal handler. Operating systems provide a variety of mechanisms in support of concurrent execution. MPI does not attempt to standardize or replace these mechanisms: it is assumed programmers who wish to define new asynchronous operations will use the mechanisms provided by the underlying operating system. Thus, the calls in this section only provide a means for defining the effect of MPI calls such as `MPI_WAIT` or `MPI_CANCEL` when they apply to generalized requests, and for signaling to MPI the completion of a generalized operation.

Rationale. It is tempting to also define an MPI standard mechanism for achieving concurrent execution of user-defined nonblocking operations. However, it is very difficult to define such a mechanism without consideration of the specific mechanisms used in the operating system. The Forum feels that concurrency mechanisms are a proper part of the underlying operating system and should not be standardized by MPI; the MPI standard should only deal with the interaction of such mechanisms with MPI. (*End of rationale.*)

1 For a regular request, the operation associated with the request is performed by the
 2 MPI implementation, and the operation completes without intervention by the application.
 3 For a generalized request, the operation associated with the request is performed by the
 4 application; therefore, the application must notify MPI when the operation completes. This
 5 is done by making a call to `MPI_GREQUEST_COMPLETE`. MPI maintains the “completion”
 6 status of generalized requests. Any other request state has to be maintained by the user.

7 A new generalized request is started with

```
8
9
10 MPI_GREQUEST_START(query_fn, free_fn, cancel_fn, extra_state, request)
11     IN          query_fn          callback function invoked when request status is queried
12                                     (function)
13     IN          free_fn           callback function invoked when request is freed (func-
14                                     tion)
15     IN          cancel_fn         callback function invoked when request is cancelled
16                                     (function)
17     IN          extra_state       extra state
18     OUT         request           generalized request (handle)
```

```
21 int MPI_Grequest_start(MPI_Grequest_query_function *query_fn,
22                       MPI_Grequest_free_function *free_fn,
23                       MPI_Grequest_cancel_function *cancel_fn, void *extra_state,
24                       MPI_Request *request)
```

```
25
26 MPI_Grequest_start(query_fn, free_fn, cancel_fn, extra_state, request,
27                   ierror) BIND(C)
28     PROCEDURE(MPI_Grequest_query_function) :: query_fn
29     PROCEDURE(MPI_Grequest_free_function)  :: free_fn
30     PROCEDURE(MPI_Grequest_cancel_function) :: cancel_fn
31     INTEGER(KIND=MPI_ADDRESS_KIND), INTENT(IN) :: extra_state
32     TYPE(MPI_Request), INTENT(OUT) :: request
33     INTEGER, OPTIONAL, INTENT(OUT) :: ierror
```

```
34 MPI_GREQUEST_START(QUERY_FN, FREE_FN, CANCEL_FN, EXTRA_STATE, REQUEST,
35                   IERROR)
36     INTEGER REQUEST, IERROR
37     EXTERNAL QUERY_FN, FREE_FN, CANCEL_FN
38     INTEGER (KIND=MPI_ADDRESS_KIND) EXTRA_STATE
```

```
40 {static MPI::Grequest
41     MPI::Grequest::Start(const MPI::Grequest::Query_function*
42                         query_fn, const MPI::Grequest::Free_function* free_fn,
43                         const MPI::Grequest::Cancel_function* cancel_fn,
44                         void *extra_state) (binding deprecated, see Section 15.2) }
```

46 *Advice to users.* Note that a generalized request belongs, in C++, to the class
 47 `MPI::Grequest`, which is a derived class of `MPI::Request`. It is of the same type as
 48 regular requests, in C and Fortran. (*End of advice to users.*)

The call starts a generalized request and returns a handle to it in `request`.

The syntax and meaning of the callback functions are listed below. All callback functions are passed the `extra_state` argument that was associated with the request by the starting call `MPI_GREQUEST_START`[. This can]; `extra_state` can be used to maintain user-defined state for the request.

In C, the query function is

```
typedef int MPI_Grequest_query_function(void *extra_state,
                                       MPI_Status *status);
```

in Fortran with the `mpi_f08` module

ABSTRACT INTERFACE

```
  SUBROUTINE MPI_Grequest_query_function(extra_state, status, ierror)
  BIND(C)
    TYPE(MPI_Status) :: status
    INTEGER(KIND=MPI_ADDRESS_KIND) :: extra_state
    INTEGER :: ierror
```

in Fortran with the `mpi` module and `mpif.h`

```
SUBROUTINE GREQUEST_QUERY_FUNCTION(EXTRA_STATE, STATUS, IERROR)
  INTEGER STATUS(MPI_STATUS_SIZE), IERROR
  INTEGER(KIND=MPI_ADDRESS_KIND) EXTRA_STATE
```

and in C++

```
{typedef int MPI::Grequest::Query_function(void* extra_state,
                                           MPI::Status& status); (binding deprecated, see Section 15.2)}
```

[`query_fn`]The `query_fn` function computes the status that should be returned for the generalized request. The status also includes information about successful/unsuccessful cancellation of the request (result to be returned by `MPI_TEST_CANCELLED`).

[`query_fn`]The `query_fn` callback is invoked by the `MPI_{WAIT|TEST}{ANY|SOME|ALL}` call that completed the generalized request associated with this callback. The callback function is also invoked by calls to `MPI_REQUEST_GET_STATUS`, if the request is complete when the call occurs. In both cases, the callback is passed a reference to the corresponding status variable passed by the user to the MPI call; the status set by the callback function is returned by the MPI call. If the user provided `MPI_STATUS_IGNORE` or `MPI_STATUSES_IGNORE` to the MPI function that causes `query_fn` to be called, then MPI will pass a valid status object to `query_fn`, and this status will be ignored upon return of the callback function. Note that `query_fn` is invoked only after `MPI_GREQUEST_COMPLETE` is called on the request; it may be invoked several times for the same generalized request, e.g., if the user calls `MPI_REQUEST_GET_STATUS` several times for this request. Note also that a call to `MPI_{WAIT|TEST}{SOME|ALL}` may cause multiple invocations of `query_fn` callback functions, one for each generalized request that is completed by the MPI call. The order of these invocations is not specified by MPI.

In C, the free function is

```
typedef int MPI_Grequest_free_function(void *extra_state);
```

in Fortran with the `mpi_f08` module

1 ABSTRACT INTERFACE

```
2 SUBROUTINE MPI_Grequest_free_function(extra_state, ierror) BIND(C)
3     INTEGER(KIND=MPI_ADDRESS_KIND) :: extra_state
4     INTEGER :: ierror
```

5 [and] in Fortran with the `mpi` module and `mpif.h`

```
6 SUBROUTINE GREQUEST_FREE_FUNCTION(EXTRA_STATE, IERROR)
7     INTEGER IERROR
8     INTEGER(KIND=MPI_ADDRESS_KIND) EXTRA_STATE
```

9 and in C++

```
10 {typedef int MPI::Grequest::Free_function(void* extra_state); (binding
11 deprecated, see Section 15.2)}
```

12 [free_fn] The `free_fn` function is invoked to clean up user-allocated resources when the
 13 generalized request is freed.

14 [free_fn] The `free_fn` callback is invoked by the `MPI_{WAIT|TEST}{ANY|SOME|ALL}`
 15 call that completed the generalized request associated with this callback. `free_fn` is invoked
 16 after the call to `query_fn` for the same request. However, if the MPI call completed multiple
 17 generalized requests, the order in which `free_fn` callback functions are invoked is not specified
 18 by MPI.

19 [free_fn] The `free_fn` callback is also invoked for generalized requests that are freed by a
 20 call to `MPI_REQUEST_FREE` (no call to `WAIT_{WAIT|TEST}{ANY|SOME|ALL}` will occur
 21 for such a request). In this case, the callback function will be called either in the MPI call
 22 `MPI_REQUEST_FREE(request)`, or in the MPI call `MPI_GREQUEST_COMPLETE(request)`,
 23 whichever happens last, i.e., in this case the actual freeing code is executed as soon as both
 24 calls `MPI_REQUEST_FREE` and `MPI_GREQUEST_COMPLETE` have occurred. The request
 25 is not deallocated until after `free_fn` completes. Note that `free_fn` will be invoked only once
 26 per request by a correct program.

27 *Advice to users.* Calling `MPI_REQUEST_FREE(request)` will cause the request handle
 28 to be set to `MPI_REQUEST_NULL`. This handle to the generalized request is no longer
 29 valid. However, user copies of this handle are valid until after `free_fn` completes since
 30 MPI does not deallocate the object until then. Since `free_fn` is not called until after
 31 `MPI_GREQUEST_COMPLETE`, the user copy of the handle can be used to make this
 32 call. Users should note that MPI will deallocate the object after `free_fn` executes. At
 33 this point, user copies of the request handle no longer point to a valid request. MPI
 34 will not set user copies to `MPI_REQUEST_NULL` in this case, so it is up to the user to
 35 avoid accessing this stale handle. This is a special case [where]in which MPI defers
 36 deallocating the object until a later time that is known by the user. (*End of advice*
 37 *to users.*)

38 In C, the cancel function is

```
39 typedef int MPI_Grequest_cancel_function(void *extra_state, int complete);
```

40 in Fortran with the `mpi_f08` module

41 ABSTRACT INTERFACE

```
42 SUBROUTINE MPI_Grequest_cancel_function(extra_state, complete, ierror)
43     BIND(C)
```

```

INTEGER(KIND=MPI_ADDRESS_KIND) :: extra_state
LOGICAL :: complete
INTEGER :: ierror

```

in Fortran with the `mpi` module and `mpif.h`

```

SUBROUTINE GREQUEST_CANCEL_FUNCTION(EXTRA_STATE, COMPLETE, IERROR)
  INTEGER IERROR
  INTEGER(KIND=MPI_ADDRESS_KIND) EXTRA_STATE
  LOGICAL COMPLETE

```

and in C++

```

{typedef int MPI::Grequest::Cancel_function(void* extra_state,
      bool complete); (binding deprecated, see Section 15.2)}

```

`[cancel_fn]` The `cancel_fn` function is invoked to start the cancelation of a generalized request. It is called by `MPI_CANCEL(request)`. MPI passes `[to the callback function complete=true]` `complete=true` to the callback function if `MPI_GREQUEST_COMPLETE` was already called on the request, and `complete=false` otherwise.

All callback functions return an error code. The code is passed back and dealt with as appropriate for the error code by the MPI function that invoked the callback function. For example, if error codes are returned then the error code returned by the callback function will be returned by the MPI function that invoked the callback function. In the case of an `MPI_{WAIT|TEST}{ANY}` call that invokes both `query_fn` and `free_fn`, the MPI call will return the error code returned by the last callback, namely `free_fn`. If one or more of the requests in a call to `MPI_{WAIT|TEST}{SOME|ALL}` failed, then the MPI call will return `MPI_ERR_IN_STATUS`. In such a case, if the MPI call was passed an array of statuses, then MPI will return in each of the statuses that correspond to a completed generalized request the error code returned by the corresponding invocation of its `free_fn` callback function. However, if the MPI function was passed `MPI_STATUSES_IGNORE`, then the individual error codes returned by each callback functions will be lost.

Advice to users. `query_fn` must **not** set the error field of `status` since `query_fn` may be called by `MPI_WAIT` or `MPI_TEST`, in which case the error field of `status` should not change. The MPI library knows the “context” in which `query_fn` is invoked and can decide correctly when to put in the error field of `status` the returned error code. *(End of advice to users.)*

`MPI_GREQUEST_COMPLETE(request)`

INOUT request generalized request (handle)

```
int MPI_Grequest_complete(MPI_Request request)
```

```

MPI_Grequest_complete(request, ierror) BIND(C)
  TYPE(MPI_Request), INTENT(IN) :: request
  INTEGER, OPTIONAL, INTENT(OUT) :: ierror

```

```
MPI_GREQUEST_COMPLETE(REQUEST, IERROR)
```

1 INTEGER REQUEST, IERROR

2 {void MPI::Grequest::Complete() (*binding deprecated, see Section 15.2*) }

3
4 The call informs MPI that the operations represented by the generalized request `request`
5 are complete (see definitions in Section 2.4). A call to `MPI_WAIT(request, status)` will
6 return and a call to `MPI_TEST(request, flag, status)` will return `flag=true` only after a call
7 to `MPI_GREQUEST_COMPLETE` has declared that these operations are complete.

8 MPI imposes no restrictions on the code executed by the callback functions. However,
9 new nonblocking operations should be defined so that the general semantic rules about MPI
10 calls such as `MPI_TEST`, `MPI_REQUEST_FREE`, or `MPI_CANCEL` still hold. For example,
11 all these calls are supposed to be local and nonblocking. Therefore, the callback functions
12 `query_fn`, `free_fn`, or `cancel_fn` should invoke blocking MPI communication calls only if the
13 context is such that these calls are guaranteed to return in finite time. Once `MPI_CANCEL`
14 is invoked, the cancelled operation should complete in finite time, irrespective of the state of
15 other processes (the operation has acquired “local” semantics). It should either succeed, or
16 fail without side-effects. The user should guarantee these same properties for newly defined
17 operations.

18
19 *Advice to implementors.* A call to `MPI_GREQUEST_COMPLETE` may unblock a
20 blocked user process/thread. The MPI library should ensure that the blocked user
21 computation will resume. (*End of advice to implementors.*)

22 23 24 25 26 27 28 29 30 31 32 33 34 35 36 37 38 39 40 41 42 43 44 45 46 47 48

12.2.1 Examples

Example 12.1 This example shows the code for a user-defined reduce operation on an `int`
using a binary tree: each non-root node receives two messages, sums them, and sends them
up. We assume that no status is returned and that the operation cannot be cancelled.

```

29 typedef struct {
30     MPI_Comm comm;
31     int tag;
32     int root;
33     int valin;
34     int *valout;
35     MPI_Request request;
36 } ARGS;
37
38
39 int myreduce(MPI_Comm comm, int tag, int root,
40             int valin, int *valout, MPI_Request *request)
41 {
42     ARGS *args;
43     pthread_t thread;
44
45     /* start request */
46     MPI_Grequest_start(query_fn, free_fn, cancel_fn, NULL, request);
47
48     args = (ARGS*)malloc(sizeof(ARGS));

```

```

args->comm = comm;
args->tag = tag;
args->root = root;
args->valin = valin;
args->valout = valout;
args->request = *request;

/* spawn thread to handle request */
/* The availability of the pthread_create call is system dependent */
pthread_create(&thread, NULL, reduce_thread, args);

return MPI_SUCCESS;
}

/* thread code */
void* reduce_thread(void *ptr)
{
    int lchild, rchild, parent, lval, rval, val;
    MPI_Request req[2];
    ARGS *args;

    args = (ARGS*)ptr;

    /* compute left,right child and parent in tree; set
       to MPI_PROC_NULL if does not exist */
    /* code not shown */
    ...

    MPI_Irecv(&lval, 1, MPI_INT, lchild, args->tag, args->comm, &req[0]);
    MPI_Irecv(&rval, 1, MPI_INT, rchild, args->tag, args->comm, &req[1]);
    MPI_Waitall(2, req, MPI_STATUSES_IGNORE);
    val = lval + args->valin + rval;
    MPI_Send (&val, 1, MPI_INT, parent, args->tag, args->comm );
    if (parent == MPI_PROC_NULL) *(args->valout) = val;
    MPI_Grequest_complete((args->request));
    free(ptr);
    return(NULL);
}

int query_fn(void *extra_state, MPI_Status *status)
{
    /* always send just one int */
    MPI_Status_set_elements(status, MPI_INT, 1);
    /* can never cancel so always true */
    MPI_Status_set_cancelled(status, 0);
    /* choose not to return a value for this */
    status->MPI_SOURCE = MPI_UNDEFINED;
    /* tag has no meaning for this generalized request */

```

```

1     status->MPI_TAG = MPI_UNDEFINED;
2     /* this generalized request never fails */
3     return MPI_SUCCESS;
4 }
5
6
7 int free_fn(void *extra_state)
8 {
9     /* this generalized request does not need to do any freeing */
10    /* as a result it never fails here */
11    return MPI_SUCCESS;
12 }
13
14
15 int cancel_fn(void *extra_state, int complete)
16 {
17     /* This generalized request does not support cancelling.
18        Abort if not already done.  If done then treat as if cancel failed.*/
19     if (!complete) {
20         fprintf(stderr,
21             "Cannot cancel generalized request - aborting program\n");
22         MPI_Abort(MPI_COMM_WORLD, 99);
23     }
24     return MPI_SUCCESS;
25 }
26
27
28

```

12.3 Associating Information with Status

MPI supports several different types of requests besides those for point-to-point operations. These range from MPI calls for I/O to generalized requests. It is desirable to allow these calls **[use]to use** the same request **[mechanism. This]mechanism, which** allows one to wait or test on different types of requests. However, `MPI_{TEST|WAIT}{ANY|SOME|ALL}` returns a status with information about the request. With the generalization of requests, one needs to define what information will be returned in the status object.

Each MPI call fills in the appropriate fields in the status object. Any unused fields will have undefined values. A call to `MPI_{TEST|WAIT}{ANY|SOME|ALL}` can modify any of the fields in the status object. Specifically, it can modify fields that are undefined. The fields with meaningful **[value]values** for a given request are defined in the sections with the new request.

Generalized requests raise additional considerations. Here, the user provides the functions to deal with the request. Unlike other MPI calls, the user needs to provide the information to be returned in status. The status argument is provided directly to the callback function where the status needs to be set. Users can directly set the values in 3 of the 5 status values. The count and cancel fields are opaque. To overcome this, these calls are provided:

```

MPI_STATUS_SET_ELEMENTS(status, datatype, count)
    INOUT  status          status with which to associate count (Status)
    IN     datatype       datatype associated with count (handle)
    IN     count          number of elements to associate with status (integer)

int MPI_Status_set_elements(MPI_Status *status, MPI_Datatype datatype,
                           int count)

MPI_Status_set_elements(status, datatype, count, ierror) BIND(C)
    TYPE(MPI_Status), INTENT(INOUT) :: status
    TYPE(MPI_Datatype), INTENT(IN)  :: datatype
    INTEGER, INTENT(IN)             :: count
    INTEGER, OPTIONAL, INTENT(OUT) :: ierror

MPI_STATUS_SET_ELEMENTS(STATUS, DATATYPE, COUNT, IERROR)
    INTEGER STATUS(MPI_STATUS_SIZE), DATATYPE, COUNT, IERROR

{void MPI::Status::Set_elements(const MPI::Datatype& datatype, int
                               count) (binding deprecated, see Section 15.2) }

MPI_STATUS_SET_ELEMENTS_X(status, datatype, count)
    INOUT  status          status with which to associate count (Status)
    IN     datatype       datatype associated with count (handle)
    IN     count          number of elements to associate with status (integer)

int MPI_Status_set_elements_x(MPI_Status *status, MPI_Datatype datatype,
                              MPI_Count count)

MPI_Status_set_elements_x(status, datatype, count, ierror) BIND(C)
    TYPE(MPI_Status), INTENT(INOUT) :: status
    TYPE(MPI_Datatype), INTENT(IN)  :: datatype
    INTEGER(KIND = MPI_COUNT_KIND), INTENT(IN) :: count
    INTEGER, OPTIONAL, INTENT(OUT) :: ierror

MPI_STATUS_SET_ELEMENTS_X(STATUS, DATATYPE, COUNT, IERROR)
    INTEGER STATUS(MPI_STATUS_SIZE), DATATYPE, IERROR
    INTEGER (KIND=MPI_COUNT_KIND) COUNT

[This call modifies] These functions modify the opaque part of status so that a call to
MPI_GET_ELEMENTS or MPI_GET_ELEMENTS_X will return count. MPI_GET_COUNT
will return a compatible value.

Rationale. The number of elements is set instead of the count because the former
can deal with a nonintegral number of datatypes. (End of rationale.)

A subsequent call to MPI_GET_COUNT(status, datatype, count) [ or to],
MPI_GET_ELEMENTS(status, datatype, count) , or MPI_GET_ELEMENTS_X(status, datatype,

```

1 **count**) must use a **datatype** argument that has the same type signature as the **datatype** ar-
 ticket265. 2 gument that was used in the call to **MPI_STATUS_SET_ELEMENTS** or
 3 **MPI_STATUS_SET_ELEMENTS_X**.

4
 ticket0. 5 *Rationale.* [This]The requirement of matching type signatures for these calls is
 6 similar to the restriction that holds when **count** is set by a receive operation: in
 ticket265. 7 that case, the calls to **MPI_GET_COUNT** [and], **MPI_GET_ELEMENTS**, and
 ticket265. 8 **MPI_GET_ELEMENTS_X** must use a **datatype** with the same signature as the **datatype**
 9 used in the receive call. (*End of rationale.*)

10
 11
 12 **MPI_STATUS_SET_CANCELLED**(**status**, **flag**)

13
 14 **INOUT** **status** status with which to associate cancel flag (Status)
 15 **IN** **flag** if true indicates request was cancelled (logical)
 16

17
 ticket-248T. 18 **int** **MPI_Status_set_cancelled**(**MPI_Status** ***status**, **int** **flag**)

19 **MPI_Status_set_cancelled**(**status**, **flag**, **ierror**) **BIND(C)**
 20 **TYPE**(**MPI_Status**), **INTENT**(**INOUT**) :: **status**
 21 **LOGICAL**, **INTENT**(**OUT**) :: **flag**
 22 **INTEGER**, **OPTIONAL**, **INTENT**(**OUT**) :: **ierror**
 23

24 **MPI_STATUS_SET_CANCELLED**(**STATUS**, **FLAG**, **IERROR**)
 25 **INTEGER** **STATUS**(**MPI_STATUS_SIZE**), **IERROR**
 26 **LOGICAL** **FLAG**

27 {**void** **MPI::Status::Set_cancelled**(**bool** **flag**) (*binding deprecated, see Section 15.2*)
 28 }
 29

30 If **flag** is set to **true** then a subsequent call to **MPI_TEST_CANCELLED**(**status**, **flag**) will
 31 also return **flag = true**, otherwise it will return **false**.

32 *Advice to users.* Users are advised not to reuse the status fields for values other
 33 than those for which they were intended. Doing so may lead to unexpected results
 34 when using the status object. For example, calling **MPI_GET_ELEMENTS** may cause
 35 an error if the value is out of range or it may be impossible to detect such an error.
 36 The **extra_state** argument provided with a generalized request can be used to return
 37 information that does not logically belong in status. Furthermore, modifying the
 38 values in a status set internally by MPI, e.g., **MPI_RECV**, may lead to unpredictable
 39 results and is strongly discouraged. (*End of advice to users.*)
 40

41 12.4 MPI and Threads

42
 43
 44 This section specifies the interaction between MPI calls and threads. The section lists
 45 minimal requirements for **thread compliant** MPI implementations and defines functions
 46 that can be used for initializing the thread environment. MPI may be implemented in
 47 environments where threads are not supported or perform poorly. Therefore, it is not
 48 required that all MPI implementations fulfill all the requirements specified in this section.

This section generally assumes a thread package similar to POSIX threads [38], but the syntax and semantics of thread calls are not specified here — these are beyond the scope of this document.

12.4.1 General

In a thread-compliant implementation, an MPI process is a process that may be multi-threaded. Each thread can issue MPI calls; however, threads are not separately addressable: a rank in a send or receive call identifies a process, not a thread. A message sent to a process can be received by any thread in this process.

Rationale. This model corresponds to the POSIX model of interprocess communication: the fact that a process is multi-threaded, rather than single-threaded, does not affect the external interface of this process. MPI implementations [where]in which MPI ‘processes’ are POSIX threads inside a single POSIX process are not thread-compliant by this definition (indeed, their “processes” are single-threaded). (*End of rationale.*)

Advice to users. It is the user’s responsibility to prevent races when threads within the same application post conflicting communication calls. The user can make sure that two threads in the same process will not issue conflicting communication calls by using distinct communicators at each thread. (*End of advice to users.*)

The two main requirements for a thread-compliant implementation are listed below.

1. All MPI calls are *thread-safe*, i.e., two concurrently running threads may make MPI calls and the outcome will be as if the calls executed in some order, even if their execution is interleaved.
2. Blocking MPI calls will block the calling thread only, allowing another thread to execute, if available. The calling thread will be blocked until the event on which it is waiting occurs. Once the blocked communication is enabled and can proceed, then the call will complete and the thread will be marked runnable, within a finite time. A blocked thread will not prevent progress of other runnable threads on the same process, and will not prevent them from executing MPI calls.

Example 12.2 Process 0 consists of two threads. The first thread executes a blocking send call `MPI_Send(buff1, count, type, 0, 0, comm)`, whereas the second thread executes a blocking receive call `MPI_Recv(buff2, count, type, 0, 0, comm, &status)`, i.e., the first thread sends a message that is received by the second thread. This communication should always succeed. According to the first requirement, the execution will correspond to some interleaving of the two calls. According to the second requirement, a call can only block the calling thread and cannot prevent progress of the other thread. If the send call went ahead of the receive call, then the sending thread may block, but this will not prevent the receiving thread from executing. Thus, the receive call will occur. Once both calls occur, the communication is enabled and both calls will complete. On the other hand, a single-threaded process that posts a send, followed by a matching receive, may deadlock. The progress requirement for multithreaded implementations is stronger, as a blocked call cannot prevent progress in other threads.

1 *Advice to implementors.* MPI calls can be made thread-safe by executing only one at
 2 a time, e.g., by protecting MPI code with one process-global lock. However, blocked
 3 operations cannot hold the lock, as this would prevent progress of other threads in
 4 the process. The lock is held only for the duration of an atomic, locally-completing
 5 suboperation such as posting a send or completing a send, and is released in between.
 6 Finer locks can provide more concurrency, at the expense of higher locking overheads.
 7 Concurrency can also be achieved by having some of the MPI protocol executed by
 8 separate server threads. (*End of advice to implementors.*)
 9

10 12.4.2 Clarifications

11
 12 **Initialization and Completion** The call to MPI_FINALIZE should occur on the same thread
 13 that initialized MPI. We call this thread the **main thread**. The call should occur only after
 14 all the process threads have completed their MPI calls, and have no pending communications
 15 or I/O operations.
 16

17 *Rationale.* This constraint simplifies implementation. (*End of rationale.*)
 18

19 **Multiple threads completing the same request.** A program where two threads block, waiting
 20 on the same request, is erroneous. Similarly, the same request cannot appear in the array of
 21 requests of two concurrent MPI_{WAIT|TEST}{ANY|SOME|ALL} calls. In MPI, a request
 ticket0. 22 can only be completed once. Any combination of wait or test [which]that violates this rule
 23 is erroneous.
 24

ticket0. 25 *Rationale.* [This]This restriction is consistent with the view that a multithreaded
 26 execution corresponds to an interleaving of the MPI calls. In a single threaded im-
 27 plementation, once a wait is posted on a request the request handle will be nullified
 28 before it is possible to post a second wait on the same handle. With threads, an
 29 MPI_WAIT{ANY|SOME|ALL} may be blocked without having nullified its request(s)
 30 so it becomes the user's responsibility to avoid using the same request in an MPI_WAIT
 31 on another thread. This constraint also simplifies implementation, as only one thread
 32 will be blocked on any communication or I/O event. (*End of rationale.*)
 33

34 **Probe** A receive call that uses source and tag values returned by a preceding call to
 35 MPI_PROBE or MPI_IPROBE will receive the message matched by the probe call only
 36 if there was no other matching receive after the probe and before that receive. In a multi-
 37 threaded environment, it is up to the user to enforce this condition using suitable mutual
 38 exclusion logic. This can be enforced by making sure that each communicator is used by
 39 only one thread on each process.
 40

41 **Collective calls** Matching of collective calls on a communicator, window, or file handle is
 42 done according to the order in which the calls are issued at each process. If concurrent
 43 threads issue such calls on the same communicator, window or file handle, it is up to the
 44 user to make sure the calls are correctly ordered, using interthread synchronization.
 45

46 *Advice to users.* With three concurrent threads in each MPI process of a communica-
 47 tor comm, it is allowed that thread A in each MPI process calls a collective operation
 48 on comm, thread B calls a file operation on an existing filehandle that was formerly

opened on `comm`, and thread C invokes one-sided operations on an existing window handle that was also formerly created on `comm`. (*End of advice to users.*)

Rationale. As already specified in `MPI_FILE_OPEN` and `MPI_WIN_CREATE`, a file handle and a window handle inherit only the group of processes of the underlying communicator, but not the communicator itself. Accesses to communicators, window handles and file handles cannot affect one another. (*End of rationale.*)

Advice to implementors. [Advice to implementors.] If the implementation of file or window operations internally uses MPI communication then a duplicated communicator may be cached on the file or window object. (*End of advice to implementors.*)

Exception handlers An exception handler does not necessarily execute in the context of the thread that made the exception-raising MPI call; the exception handler may be executed by a thread that is distinct from the thread that will return the error code.

Rationale. The MPI implementation may be multithreaded, so that part of the communication protocol may execute on a thread that is distinct from the thread that made the MPI call. The design allows the exception handler to be executed on the thread where the exception occurred. (*End of rationale.*)

Interaction with signals and cancellations The outcome is undefined if a thread that executes an MPI call is cancelled (by another thread), or if a thread catches a signal while executing an MPI call. However, a thread of an MPI process may terminate, and may catch signals or be cancelled by another thread when not executing MPI calls.

Rationale. Few C library functions are signal safe, and many have cancellation points — points [where]at which the thread executing them may be cancelled. The above restriction simplifies implementation (no need for the MPI library to be “async-cancel-safe” or [“async-signal-safe.”]“async-signal-safe”). (*End of rationale.*)

Advice to users. Users can catch signals in separate, non-MPI threads (e.g., by masking signals on MPI calling threads, and unmasking them in one or more non-MPI threads). A good programming practice is to have a distinct thread blocked in a call to `sigwait` for each user expected signal that may occur. Users must not catch signals used by the MPI implementation; as each MPI implementation is required to document the signals used internally, users can avoid these signals. (*End of advice to users.*)

Advice to implementors. The MPI library should not invoke library calls that are not thread safe, if multiple threads execute. (*End of advice to implementors.*)

12.4.3 Initialization

The following function may be used to initialize MPI, and initialize the MPI thread environment, instead of `MPI_INIT`.

1 MPI_INIT_THREAD(required, provided)

2 IN required desired level of thread support (integer)

3 OUT provided provided level of thread support (integer)

4
5
6 int MPI_Init_thread(int *argc, char *((*argv)[]), int required,
7 int *provided)

8 MPI_Init_thread(required, provided, ierror) BIND(C)

9 INTEGER, INTENT(IN) :: required

10 INTEGER, INTENT(OUT) :: provided

11 INTEGER, OPTIONAL, INTENT(OUT) :: ierror

12
13 MPI_INIT_THREAD(REQUIRED, PROVIDED, IERROR)

14 INTEGER REQUIRED, PROVIDED, IERROR

15 {int MPI::Init_thread(int& argc, char**& argv, int required) (*binding*
16 *deprecated, see Section 15.2*) }

17
18 {int MPI::Init_thread(int required) (*binding deprecated, see Section 15.2*) }

19
20 *Advice to users.* In C and C++, the passing of argc and argv is [optional.]optional,
21 as with MPI_INIT as discussed in Section 8.7. In C, [this is accomplished by passing
22 the appropriate null pointer.] null pointers may be passed in their place. In C++,
23 [this is accomplished with two separate bindings to cover these two cases. This is as
24 with MPI_INIT as discussed in Section 8.7.]two separate bindings support this choice.
25 (*End of advice to users.*)

26
27 This call initializes MPI in the same way that a call to MPI_INIT would. In addition,
28 it initializes the thread environment. The argument required is used to specify the desired
29 level of thread support. The possible values are listed in increasing order of thread support.

30
31 **MPI_THREAD_SINGLE** Only one thread will execute.

32 **MPI_THREAD_FUNNELED** The process may be multi-threaded, but the application must
33 ensure that only the main thread makes MPI calls (for the definition of main thread,
34 see MPI_IS_THREAD_MAIN on page 510).

35
36 **MPI_THREAD_SERIALIZED** The process may be multi-threaded, and multiple threads may
37 make MPI calls, but only one at a time: MPI calls are not made concurrently from
38 two distinct threads (all MPI calls are “serialized”).

39 **MPI_THREAD_MULTIPLE** Multiple threads may call MPI, with no restrictions.

40
41 These values are monotonic; i.e., MPI_THREAD_SINGLE < MPI_THREAD_FUNNELED <
42 MPI_THREAD_SERIALIZED < MPI_THREAD_MULTIPLE.

43 Different processes in MPI_COMM_WORLD may require different levels of thread sup-
44 port.

45 The call returns in provided information about the actual level of thread support that
46 will be provided by MPI. It can be one of the four values listed above.

47 The level(s) of thread support that can be provided by MPI_INIT_THREAD will depend
48 on the implementation, and may depend on information provided by the user before the

program started to execute (e.g., with arguments to `mpiexec`). If possible, the call will return `provided = required`. Failing this, the call will return the least supported level such that `provided > required` (thus providing a stronger level of support than required by the user). Finally, if the user requirement cannot be satisfied, then the call will return in `provided` the highest supported level.

A **thread compliant** MPI implementation will be able to return `provided = MPI_THREAD_MULTIPLE`. Such an implementation may always return `provided = MPI_THREAD_MULTIPLE`, irrespective of the value of `required`. At the other extreme, an MPI library that is not thread compliant may always return `provided = MPI_THREAD_SINGLE`, irrespective of the value of `required`.

A call to `MPI_INIT` has the same effect as a call to `MPI_INIT_THREAD` with a `required = MPI_THREAD_SINGLE`.

Vendors may provide (implementation dependent) means to specify the level(s) of thread support available when the MPI program is started, e.g., with arguments to `mpiexec`. This will affect the outcome of calls to `MPI_INIT` and `MPI_INIT_THREAD`. Suppose, for example, that an MPI program has been started so that only `MPI_THREAD_MULTIPLE` is available. Then `MPI_INIT_THREAD` will return `provided = MPI_THREAD_MULTIPLE`, irrespective of the value of `required`; a call to `MPI_INIT` will also initialize the MPI thread support level to `MPI_THREAD_MULTIPLE`. Suppose, on the other hand, that an MPI program has been started so that all four levels of thread support are available. Then, a call to `MPI_INIT_THREAD` will return `provided = required`; on the other hand, a call to `MPI_INIT` will initialize the MPI thread support level to `MPI_THREAD_SINGLE`.

Rationale. Various optimizations are possible when MPI code is executed single-threaded, or is executed on multiple threads, but not concurrently: mutual exclusion code may be omitted. Furthermore, if only one thread executes, then the MPI library can use library functions that are not thread safe, without risking conflicts with user threads. Also, the model of one communication thread, multiple computation threads fits many applications well, e.g., if the process code is a sequential Fortran/C/C++ program with MPI calls that has been parallelized by a compiler for execution on an SMP node, in a cluster of SMPs, then the process computation is multi-threaded, but MPI calls will likely execute on a single thread.

The design accommodates a static specification of the thread support level, for environments that require static binding of libraries, and for compatibility for current multi-threaded MPI codes. (*End of rationale.*)

Advice to implementors. If `provided` is not `MPI_THREAD_SINGLE` then the MPI library should not invoke C/C++/Fortran library calls that are not thread safe, e.g., in an environment where `malloc` is not thread safe, then `malloc` should not be used by the MPI library.

Some implementors may want to use different MPI libraries for different levels of thread support. They can do so using dynamic linking and selecting which library will be linked when `MPI_INIT_THREAD` is invoked. If this is not possible, then optimizations for lower levels of thread support will occur only when the level of thread support required is specified at link time. (*End of advice to implementors.*)

The following function can be used to query the current level of thread support.

1 MPI_QUERY_THREAD(provided)

2 OUT provided provided level of thread support (integer)

3
4
5 int MPI_Query_thread(int *provided)

6 MPI_Query_thread(provided, ierror) BIND(C)

7 INTEGER, INTENT(OUT) :: provided

8 INTEGER, OPTIONAL, INTENT(OUT) :: ierror

9
10 MPI_QUERY_THREAD(PROVIDED, IERROR)

11 INTEGER PROVIDED, IERROR

12 {int MPI::Query_thread() (binding deprecated, see Section 15.2) }

ticket0. 13
14 The call returns in provided the current level of thread [support. This]support, which
15 will be the value returned in provided by MPI_INIT_THREAD, if MPI was initialized by a
16 call to MPI_INIT_THREAD().

17
18 MPI_IS_THREAD_MAIN(flag)

19 OUT flag true if calling thread is main thread, false otherwise
20 (logical)

21
22
23 int MPI_Is_thread_main(int *flag)

ticket0. 24 MPI_Is_thread_main(flag, ierror) BIND(C)

25 LOGICAL, INTENT(OUT) :: flag

26 INTEGER, OPTIONAL, INTENT(OUT) :: ierror

27
28 MPI_IS_THREAD_MAIN(FLAG, IERROR)

29 LOGICAL FLAG

30 INTEGER IERROR

31 {bool MPI::Is_thread_main() (binding deprecated, see Section 15.2) }

ticket0. 32
33 This function can be called by a thread to [find out whether]determine if it is the main
34 thread (the thread that called MPI_INIT or MPI_INIT_THREAD).

35 All routines listed in this section must be supported by all MPI implementations.

36
37 *Rationale.* MPI libraries are required to provide these calls even if they do not
38 support threads, so that portable code that contains invocations to these functions
ticket0. 39 [be able to]can link correctly. MPI_INIT continues to be supported so as to provide
40 compatibility with current MPI codes. (*End of rationale.*)

41
42 *Advice to users.* It is possible to spawn threads before MPI is initialized, but no
43 MPI call other than MPI_INITIALIZED should be executed by these threads, until
44 MPI_INIT_THREAD is invoked by one thread (which, thereby, becomes the main
45 thread). In particular, it is possible to enter the MPI execution with a multi-threaded
46 process.

47 The level of thread support provided is a global property of the MPI process that can
48 be specified only once, when MPI is initialized on that process (or before). Portable

third party libraries have to be written so as to accommodate any provided level of thread support. Otherwise, their usage will be restricted to specific level(s) of thread support. If such a library can run only with specific level(s) of thread support, e.g., only with `MPI_THREAD_MULTIPLE`, then `MPI_QUERY_THREAD` can be used to check whether the user initialized MPI to the correct level of thread support and, if not, raise an exception. (*End of advice to users.*)

1
2
3
4
5
6
7
8
9
10
11
12
13
14
15
16
17
18
19
20
21
22
23
24
25
26
27
28
29
30
31
32
33
34
35
36
37
38
39
40
41
42
43
44
45
46
47
48

1
2
3
4
5
6
7
8
9
10
11
12
13
14
15
16
17
18
19
20
21
22
23
24
25
26
27
28
29
30
31
32
33
34
35
36
37
38
39
40
41
42
43
44
45
46
47
48

1
2
3
4
5
6
7
8
9
10
11
12
13
14
15
16
17
18
19
20
21
22
23
24
25
26
27
28
29
30
31
32
33
34
35
36
37
38
39
40
41
42
43
44
45
46
47
48

Chapter 13

I/O

13.1 Introduction

POSIX provides a model of a widely portable file system, but the portability and optimization needed for parallel I/O cannot be achieved with the POSIX interface.

The significant optimizations required for efficiency (e.g., grouping [47], collective buffering [7, 14, 48, 52, 59], and disk-directed I/O [43]) can only be implemented if the parallel I/O system provides a high-level interface supporting partitioning of file data among processes and a collective interface supporting complete transfers of global data structures between process memories and files. In addition, further efficiencies can be gained via support for asynchronous I/O, strided accesses, and control over physical file layout on storage devices (disks). The I/O environment described in this chapter provides these facilities.

Instead of defining I/O access modes to express the common patterns for accessing a shared file (broadcast, reduction, scatter, gather), we chose another approach in which data partitioning is expressed using derived datatypes. Compared to a limited set of predefined access patterns, this approach has the advantage of added flexibility and expressiveness.

13.1.1 Definitions

file An MPI file is an ordered collection of typed data items. MPI supports random or sequential access to any integral set of these items. A file is opened collectively by a group of processes. All collective I/O calls on a file are collective over this group.

displacement A file *displacement* is an absolute byte position relative to the beginning of a file. The displacement defines the location where a *view* begins. Note that a “file displacement” is distinct from a “typemap displacement.”

etype An *etype* (*elementary datatype*) is the unit of data access and positioning. It can be any MPI predefined or derived datatype. Derived etypes can be constructed using any of the MPI datatype constructor routines, provided all resulting typemap displacements are non-negative and monotonically nondecreasing. Data access is performed in etype units, reading or writing whole data items of type etype. Offsets are expressed as a count of etypes; file pointers point to the beginning of etypes. Depending on context, the term “etype” is used to describe one of three aspects of an elementary datatype: a particular MPI type, a data item of that type, or the extent of that type.

filetype A *filetype* is the basis for partitioning a file among processes and defines a template for accessing the file. A filetype is either a single etype or a derived MPI datatype constructed from multiple instances of the same etype. In addition, the extent of any hole in the filetype must be a multiple of the etype's extent. The displacements in the typemap of the filetype are not required to be distinct, but they must be non-negative and monotonically nondecreasing.

view A *view* defines the current set of data visible and accessible from an open file as an ordered set of etypes. Each process has its own view of the file, defined by three quantities: a displacement, an etype, and a filetype. The pattern described by a filetype is repeated, beginning at the displacement, to define the view. The pattern of repetition is defined to be the same pattern that `MPI_TYPE_CONTIGUOUS` would produce if it were passed the filetype and an arbitrarily large count. Figure 13.1 shows how the tiling works; note that the filetype in this example must have explicit lower and upper bounds set in order for the initial and final holes to be repeated in the view. Views can be changed by the user during program execution. The default view is a linear byte stream (displacement is zero, etype and filetype equal to `MPI_BYTE`).

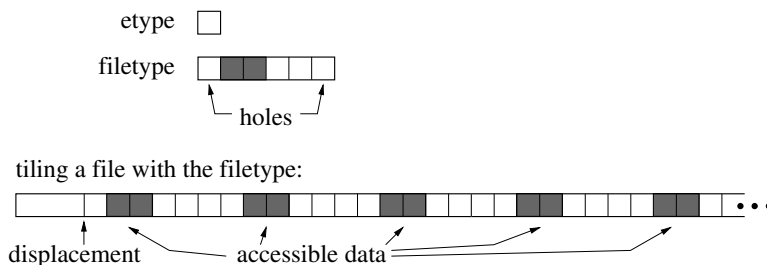

Figure 13.1: Etypes and filetypes

A group of processes can use complementary views to achieve a global data distribution such as a scatter/gather pattern (see Figure 13.2).

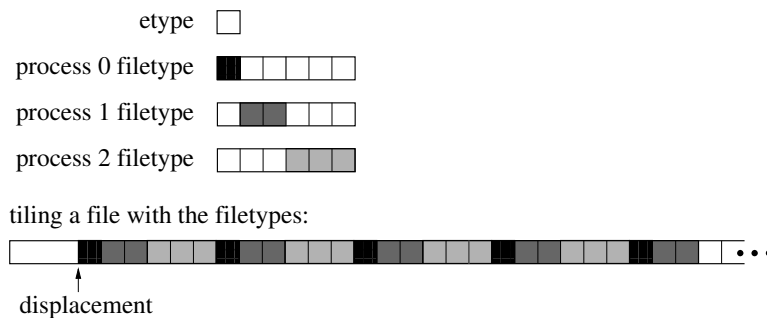

Figure 13.2: Partitioning a file among parallel processes

offset An *offset* is a position in the file relative to the current view, expressed as a count of etypes. Holes in the view's filetype are skipped when calculating this position. Offset 0 is the location of the first etype visible in the view (after skipping the displacement and any initial holes in the view). For example, an offset of 2 for process 1 in Figure 13.2 is the position of the 8th etype in the file after the displacement. An “explicit offset” is an offset that is used as a formal parameter in explicit data access routines.

file size and end of file The *size* of an MPI file is measured in bytes from the beginning of the file. A newly created file has a size of zero bytes. Using the size as an absolute displacement gives the position of the byte immediately following the last byte in the file. For any given view, the *end of file* is the offset of the first etype accessible in the current view starting after the last byte in the file.

file pointer A *file pointer* is an implicit offset maintained by MPI. “Individual file pointers” are file pointers that are local to each process that opened the file. A “shared file pointer” is a file pointer that is shared by the group of processes that opened the file.

file handle A *file handle* is an opaque object created by MPI_FILE_OPEN and freed by MPI_FILE_CLOSE. All operations on an open file reference the file through the file handle.

13.2 File Manipulation

13.2.1 Opening a File

MPI_FILE_OPEN(comm, filename, amode, info, fh)

IN	comm	communicator (handle)
IN	filename	name of file to open (string)
IN	amode	file access mode (integer)
IN	info	info object (handle)
OUT	fh	new file handle (handle)

```
int MPI_File_open(MPI_Comm comm, const char *filename, int amode,
                 MPI_Info info, MPI_File *fh)
```

```
MPI_File_open(comm, filename, amode, info, fh, ierror) BIND(C)
  TYPE(MPI_Comm), INTENT(IN) :: comm
  CHARACTER(LEN=*), INTENT(IN) :: filename
  INTEGER, INTENT(IN) :: amode
  TYPE(MPI_Info), INTENT(IN) :: info
  TYPE(MPI_File), INTENT(OUT) :: fh
  INTEGER, OPTIONAL, INTENT(OUT) :: ierror
```

```
MPI_FILE_OPEN(COMM, FILENAME, AMODE, INFO, FH, IERROR)
  CHARACTER*(*) FILENAME
  INTEGER COMM, AMODE, INFO, FH, IERROR
```

```
{static MPI::File MPI::File::Open(const MPI::Intracomm& comm,
    const char* filename, int amode, const MPI::Info& info) (binding
    deprecated, see Section 15.2) }
```

MPI_FILE_OPEN opens the file identified by the file name `filename` on all processes in the `comm` communicator group. MPI_FILE_OPEN is a collective routine: all processes must provide the same value for `amode`, and all processes must provide filenames that reference

1 the same file. (Values for `info` may vary.) `comm` must be an intracommunicator; it is
 2 erroneous to pass an intercommunicator to `MPI_FILE_OPEN`. Errors in `MPI_FILE_OPEN`
 3 are raised using the default file error handler (see Section 13.7, page 578). A process can
 4 open a file independently of other processes by using the `MPI_COMM_SELF` communicator.
 5 The file handle returned, `fh`, can be subsequently used to access the file until the file is
 6 closed using `MPI_FILE_CLOSE`. Before calling `MPI_FINALIZE`, the user is required to close
 7 (via `MPI_FILE_CLOSE`) all files that were opened with `MPI_FILE_OPEN`. Note that the
 8 communicator `comm` is unaffected by `MPI_FILE_OPEN` and continues to be usable in all
 9 MPI routines (e.g., `MPI_SEND`). Furthermore, the use of `comm` will not interfere with I/O
 10 behavior.

11 The format for specifying the file name in the `filename` argument is implementation
 12 dependent and must be documented by the implementation.

13
 14 *Advice to implementors.* An implementation may require that `filename` include a
 15 string or strings specifying additional information about the file. Examples include
 16 the type of filesystem (e.g., a prefix of `ufs:`), a remote hostname (e.g., a prefix of
 17 `machine.univ.edu:`), or a file password (e.g., a suffix of `/PASSWORD=SECRET`).
 18 (*End of advice to implementors.*)

19
 20 *Advice to users.* On some implementations of MPI, the file namespace may not be
 21 identical from all processes of all applications. For example, `"/tmp/foo"` may denote
 22 different files on different processes, or a single file may have many names, dependent
 23 on process location. The user is responsible for ensuring that a single file is referenced
 24 by the `filename` argument, as it may be impossible for an implementation to detect
 25 this type of namespace error. (*End of advice to users.*)

26
 27 Initially, all processes view the file as a linear byte stream, and each process views data
 28 in its own native representation (no data representation conversion is performed). (POSIX
 29 files are linear byte streams in the native representation.) The file view can be changed via
 30 the `MPI_FILE_SET_VIEW` routine.

31 The following access modes are supported (specified in `amode`, a bit vector OR of the
 32 following integer constants):

- 33 ● `MPI_MODE_RDONLY` — read only,
- 34
- 35 ● `MPI_MODE_RDWR` — reading and writing,
- 36
- 37 ● `MPI_MODE_WRONLY` — write only,
- 38
- 39 ● `MPI_MODE_CREATE` — create the file if it does not exist,
- 40
- 41 ● `MPI_MODE_EXCL` — error if creating file that already exists,
- 42
- 43 ● `MPI_MODE_DELETE_ON_CLOSE` — delete file on close,
- 44
- 45 ● `MPI_MODE_UNIQUE_OPEN` — file will not be concurrently opened elsewhere,
- 46
- 47 ● `MPI_MODE_SEQUENTIAL` — file will only be accessed sequentially,
- 48
- `MPI_MODE_APPEND` — set initial position of all file pointers to end of file.

Advice to users. C/C++ users can use bit vector OR (|) to combine these constants; Fortran 90 users can use the bit vector IOR intrinsic. Fortran 77 users can use (non-portably) bit vector IOR on systems that support it. Alternatively, Fortran users can portably use integer addition to OR the constants (each constant should appear at most once in the addition.). (*End of advice to users.*)

Advice to implementors. The values of these constants must be defined such that the bitwise OR and the sum of any distinct set of these constants is equivalent. (*End of advice to implementors.*)

The modes MPI_MODE_RDONLY, MPI_MODE_RDWR, MPI_MODE_WRONLY, MPI_MODE_CREATE, and MPI_MODE_EXCL have identical semantics to their POSIX counterparts [38]. Exactly one of MPI_MODE_RDONLY, MPI_MODE_RDWR, or MPI_MODE_WRONLY, must be specified. It is erroneous to specify MPI_MODE_CREATE or MPI_MODE_EXCL in conjunction with MPI_MODE_RDONLY; it is erroneous to specify MPI_MODE_SEQUENTIAL together with MPI_MODE_RDWR.

The MPI_MODE_DELETE_ON_CLOSE mode causes the file to be deleted (equivalent to performing an MPI_FILE_DELETE) when the file is closed.

The MPI_MODE_UNIQUE_OPEN mode allows an implementation to optimize access by eliminating the overhead of file locking. It is erroneous to open a file in this mode unless the file will not be concurrently opened elsewhere.

Advice to users. For MPI_MODE_UNIQUE_OPEN, *not opened elsewhere* includes both inside and outside the MPI environment. In particular, one needs to be aware of potential external events which may open files (e.g., automated backup facilities). When MPI_MODE_UNIQUE_OPEN is specified, the user is responsible for ensuring that no such external events take place. (*End of advice to users.*)

The MPI_MODE_SEQUENTIAL mode allows an implementation to optimize access to some sequential devices (tapes and network streams). It is erroneous to attempt non-sequential access to a file that has been opened in this mode.

Specifying MPI_MODE_APPEND only guarantees that all shared and individual file pointers are positioned at the initial end of file when MPI_FILE_OPEN returns. Subsequent positioning of file pointers is application dependent. In particular, the implementation does not ensure that all writes are appended.

Errors related to the access mode are raised in the class MPI_ERR_AMODE.

The info argument is used to provide information regarding file access patterns and file system specifics (see Section 13.2.8, page 523). The constant MPI_INFO_NULL can be used when no info needs to be specified.

Advice to users. Some file attributes are inherently implementation dependent (e.g., file permissions). These attributes must be set using either the info argument or facilities outside the scope of MPI. (*End of advice to users.*)

Files are opened by default using nonatomic mode file consistency semantics (see Section 13.6.1, page 569). The more stringent atomic mode consistency semantics, required for atomicity of conflicting accesses, can be set using MPI_FILE_SET_ATOMICITY.

13.2.2 Closing a File

MPI_FILE_CLOSE(fh)

INOUT fh file handle (handle)

```
int MPI_File_close(MPI_File *fh)
```

```
MPI_File_close(fh, ierror) BIND(C)
    TYPE(MPI_File), INTENT(INOUT) :: fh
    INTEGER, OPTIONAL, INTENT(OUT) :: ierror
```

```
MPI_FILE_CLOSE(FH, IERROR)
    INTEGER FH, IERROR
```

```
{void MPI::File::Close() (binding deprecated, see Section 15.2) }
```

MPI_FILE_CLOSE first synchronizes file state (equivalent to performing an MPI_FILE_SYNC), then closes the file associated with fh. The file is deleted if it was opened with access mode MPI_MODE_DELETE_ON_CLOSE (equivalent to performing an MPI_FILE_DELETE). MPI_FILE_CLOSE is a collective routine.

Advice to users. If the file is deleted on close, and there are other processes currently accessing the file, the status of the file and the behavior of future accesses by these processes are implementation dependent. (*End of advice to users.*)

The user is responsible for ensuring that all outstanding nonblocking requests and split collective operations associated with fh made by a process have completed before that process calls MPI_FILE_CLOSE.

The MPI_FILE_CLOSE routine deallocates the file handle object and sets fh to MPI_FILE_NULL.

13.2.3 Deleting a File

MPI_FILE_DELETE(filename, info)

IN filename name of file to delete (string)

IN info info object (handle)

```
int MPI_File_delete(const char *filename, MPI_Info info)
```

```
MPI_File_delete(filename, info, ierror) BIND(C)
    CHARACTER(LEN=*) INTENT(IN) :: filename
    TYPE(MPI_Info), INTENT(IN) :: info
    INTEGER, OPTIONAL, INTENT(OUT) :: ierror
```

```
MPI_FILE_DELETE(FILENAME, INFO, IERROR)
    CHARACTER*(*) FILENAME
    INTEGER INFO, IERROR
```

```
{static void MPI::File::Delete(const char* filename,
                               const MPI::Info& info) (binding deprecated, see Section 15.2) }
```

MPI_FILE_DELETE deletes the file identified by the file name `filename`. If the file does not exist, MPI_FILE_DELETE raises an error in the class MPI_ERR_NO_SUCH_FILE.

The `info` argument can be used to provide information regarding file system specifics (see Section 13.2.8, page 523). The constant MPI_INFO_NULL refers to the null info, and can be used when no info needs to be specified.

If a process currently has the file open, the behavior of any access to the file (as well as the behavior of any outstanding accesses) is implementation dependent. In addition, whether an open file is deleted or not is also implementation dependent. If the file is not deleted, an error in the class MPI_ERR_FILE_IN_USE or MPI_ERR_ACCESS will be raised. Errors are raised using the default error handler (see Section 13.7, page 578).

13.2.4 Resizing a File

MPI_FILE_SET_SIZE(fh, size)

INOUT	fh	file handle (handle)
IN	size	size to truncate or expand file (integer)

```
int MPI_File_set_size(MPI_File fh, MPI_Offset size)
```

```
MPI_File_set_size(fh, size, ierror) BIND(C)
  TYPE(MPI_File), INTENT(IN) :: fh
  INTEGER(KIND=MPI_OFFSET_KIND), INTENT(IN) :: size
  INTEGER, OPTIONAL, INTENT(OUT) :: ierror
```

```
MPI_FILE_SET_SIZE(FH, SIZE, IERROR)
  INTEGER FH, IERROR
  INTEGER(KIND=MPI_OFFSET_KIND) SIZE
```

```
{void MPI::File::Set_size(MPI::Offset size) (binding deprecated, see Section 15.2)
  }
```

MPI_FILE_SET_SIZE resizes the file associated with the file handle `fh`. `size` is measured in bytes from the beginning of the file. MPI_FILE_SET_SIZE is collective; all processes in the group must pass identical values for `size`.

If `size` is smaller than the current file size, the file is truncated at the position defined by `size`. The implementation is free to deallocate file blocks located beyond this position.

If `size` is larger than the current file size, the file size becomes `size`. Regions of the file that have been previously written are unaffected. The values of data in the new regions in the file (those locations with displacements between old file size and `size`) are undefined. It is implementation dependent whether the MPI_FILE_SET_SIZE routine allocates file space—use MPI_FILE_PREALLOCATE to force file space to be reserved.

MPI_FILE_SET_SIZE does not affect the individual file pointers or the shared file pointer. If MPI_MODE_SEQUENTIAL mode was specified when the file was opened, it is erroneous to call this routine.

ticket-248T.

1 *Advice to users.* It is possible for the file pointers to point beyond the end of file
 2 after a `MPI_FILE_SET_SIZE` operation truncates a file. This is valid, and equivalent
 3 to seeking beyond the current end of file. (*End of advice to users.*)

4
 5 All nonblocking requests and split collective operations on `fh` must be completed before
 6 calling `MPI_FILE_SET_SIZE`. Otherwise, calling `MPI_FILE_SET_SIZE` is erroneous. As far
 7 as consistency semantics are concerned, `MPI_FILE_SET_SIZE` is a write operation that
 8 conflicts with operations that access bytes at displacements between the old and new file
 9 sizes (see Section 13.6.1, page 569).

11 13.2.5 Preallocating Space for a File

12
 13
 14 `MPI_FILE_PREALLOCATE(fh, size)`

15 INOUT `fh` file handle (handle)
 16 IN `size` size to preallocate file (integer)

17
 18
 19 `int MPI_File_preallocate(MPI_File fh, MPI_Offset size)`

20 `MPI_File_preallocate(fh, size, ierror) BIND(C)`
 21 `TYPE(MPI_File), INTENT(IN) :: fh`
 22 `INTEGER(KIND=MPI_OFFSET_KIND), INTENT(IN) :: size`
 23 `INTEGER, OPTIONAL, INTENT(OUT) :: ierror`

24
 25 `MPI_FILE_PREALLOCATE(FH, SIZE, IERROR)`
 26 `INTEGER FH, IERROR`
 27 `INTEGER(KIND=MPI_OFFSET_KIND) SIZE`

28
 29 `{void MPI::File::Preallocate(MPI::Offset size) (binding deprecated, see`
 30 `Section 15.2) }`

31
 32 `MPI_FILE_PREALLOCATE` ensures that storage space is allocated for the first `size` bytes
 33 of the file associated with `fh`. `MPI_FILE_PREALLOCATE` is collective; all processes in the
 34 group must pass identical values for `size`. Regions of the file that have previously been
 35 written are unaffected. For newly allocated regions of the file, `MPI_FILE_PREALLOCATE`
 36 has the same effect as writing undefined data. If `size` is larger than the current file size, the
 37 file size increases to `size`. If `size` is less than or equal to the current file size, the file size is
 38 unchanged.

39 The treatment of file pointers, pending nonblocking accesses, and file consistency is the
 40 same as with `MPI_FILE_SET_SIZE`. If `MPI_MODE_SEQUENTIAL` mode was specified when
 41 the file was opened, it is erroneous to call this routine.

42 *Advice to users.* In some implementations, file preallocation may be expensive. (*End*
 43 *of advice to users.*)

13.2.6 Querying the Size of a File

MPI_FILE_GET_SIZE(fh, size)

IN	fh	file handle (handle)
OUT	size	size of the file in bytes (integer)

```
int MPI_File_get_size(MPI_File fh, MPI_Offset *size)
```

```
MPI_File_get_size(fh, size, ierror) BIND(C)
  TYPE(MPI_File), INTENT(IN) :: fh
  INTEGER(KIND=MPI_OFFSET_KIND), INTENT(OUT) :: size
  INTEGER, OPTIONAL, INTENT(OUT) :: ierror
```

```
MPI_FILE_GET_SIZE(FH, SIZE, IERROR)
  INTEGER FH, IERROR
  INTEGER(KIND=MPI_OFFSET_KIND) SIZE
```

```
{MPI::Offset MPI::File::Get_size() const(binding deprecated, see Section 15.2) }
```

MPI_FILE_GET_SIZE returns, in `size`, the current size in bytes of the file associated with the file handle `fh`. As far as consistency semantics are concerned, MPI_FILE_GET_SIZE is a data access operation (see Section 13.6.1, page 569).

13.2.7 Querying File Parameters

MPI_FILE_GET_GROUP(fh, group)

IN	fh	file handle (handle)
OUT	group	group which opened the file (handle)

```
int MPI_File_get_group(MPI_File fh, MPI_Group *group)
```

```
MPI_File_get_group(fh, group, ierror) BIND(C)
  TYPE(MPI_File), INTENT(IN) :: fh
  TYPE(MPI_Group), INTENT(OUT) :: group
  INTEGER, OPTIONAL, INTENT(OUT) :: ierror
```

```
MPI_FILE_GET_GROUP(FH, GROUP, IERROR)
  INTEGER FH, GROUP, IERROR
```

```
{MPI::Group MPI::File::Get_group() const(binding deprecated, see Section 15.2) }
```

MPI_FILE_GET_GROUP returns a duplicate of the group of the communicator used to open the file associated with `fh`. The group is returned in `group`. The user is responsible for freeing `group`.

```

1 MPI_FILE_GET_AMODE(fh, amode)
2     IN      fh                file handle (handle)
3
4     OUT     amode             file access mode used to open the file (integer)
5

```

```

6 int MPI_File_get_amode(MPI_File fh, int *amode)

```

```

7 MPI_File_get_amode(fh, amode, ierror) BIND(C)
8     TYPE(MPI_File), INTENT(IN) :: fh
9     INTEGER, INTENT(OUT) :: amode
10    INTEGER, OPTIONAL, INTENT(OUT) :: ierror
11

```

```

12 MPI_FILE_GET_AMODE(FH, AMODE, IERROR)
13     INTEGER FH, AMODE, IERROR

```

```

14 {int MPI::File::Get_amode() const(binding deprecated, see Section 15.2) }

```

16 MPI_FILE_GET_AMODE returns, in amode, the access mode of the file associated with
17 fh.

19 **Example 13.1** In Fortran 77, decoding an amode bit vector will require a routine such as
20 the following:

```

21
22     SUBROUTINE BIT_QUERY(TEST_BIT, MAX_BIT, AMODE, BIT_FOUND)
23     !
24     ! TEST IF THE INPUT TEST_BIT IS SET IN THE INPUT AMODE
25     ! IF SET, RETURN 1 IN BIT_FOUND, 0 OTHERWISE
26     !
27     INTEGER TEST_BIT, AMODE, BIT_FOUND, CP_AMODE, HIFOUND
28     BIT_FOUND = 0
29     CP_AMODE = AMODE
30 100 CONTINUE
31     LBIT = 0
32     HIFOUND = 0
33     DO 20 L = MAX_BIT, 0, -1
34         MATCHER = 2**L
35         IF (CP_AMODE .GE. MATCHER .AND. HIFOUND .EQ. 0) THEN
36             HIFOUND = 1
37             LBIT = MATCHER
38             CP_AMODE = CP_AMODE - MATCHER
39         END IF
40 20 CONTINUE
41     IF (HIFOUND .EQ. 1 .AND. LBIT .EQ. TEST_BIT) BIT_FOUND = 1
42     IF (BIT_FOUND .EQ. 0 .AND. HIFOUND .EQ. 1 .AND. &
43         CP_AMODE .GT. 0) GO TO 100
44     END

```

46 This routine could be called successively to decode amode, one bit at a time. For
47 example, the following code fragment would check for MPI_MODE_RDONLY.

```

CALL BIT_QUERY(MPI_MODE_RDONLY, 30, AMODE, BIT_FOUND)
IF (BIT_FOUND .EQ. 1) THEN
    PRINT *, ' FOUND READ-ONLY BIT IN AMODE=', AMODE
ELSE
    PRINT *, ' READ-ONLY BIT NOT FOUND IN AMODE=', AMODE
END IF

```

13.2.8 File Info

Hints specified via info (see Section 9, page 385) allow a user to provide information such as file access patterns and file system specifics to direct optimization. Providing hints may enable an implementation to deliver increased I/O performance or minimize the use of system resources. However, hints do not change the semantics of any of the I/O interfaces. In other words, an implementation is free to ignore all hints. Hints are specified on a per file basis, in `MPI_FILE_OPEN`, `MPI_FILE_DELETE`, `MPI_FILE_SET_VIEW`, and `MPI_FILE_SET_INFO`, via the opaque info object. When an info object that specifies a subset of valid hints is passed to `MPI_FILE_SET_VIEW` or `MPI_FILE_SET_INFO`, there will be no effect on previously set or defaulted hints that the info does not specify.

Advice to implementors. It may happen that a program is coded with hints for one system, and later executes on another system that does not support these hints. In general, unsupported hints should simply be ignored. Needless to say, no hint can be mandatory. However, for each hint used by a specific implementation, a default value must be provided when the user does not specify a value for this hint. (*End of advice to implementors.*)

`MPI_FILE_SET_INFO(fh, info)`

INOUT	fh	file handle (handle)
IN	info	info object (handle)

`int MPI_File_set_info(MPI_File fh, MPI_Info info)`

```

MPI_File_set_info(fh, info, ierror) BIND(C)
    TYPE(MPI_File), INTENT(IN) :: fh
    TYPE(MPI_Info), INTENT(IN) :: info
    INTEGER, OPTIONAL, INTENT(OUT) :: ierror

```

`MPI_FILE_SET_INFO(FH, INFO, IERROR)`

`INTEGER FH, INFO, IERROR`

```

{void MPI::File::Set_info(const MPI::Info& info) (binding deprecated, see
    Section 15.2) }

```

`MPI_FILE_SET_INFO` sets new values for the hints of the file associated with `fh`. `MPI_FILE_SET_INFO` is a collective routine. The info object may be different on each process, but any info entries that an implementation requires to be the same on all processes must appear with the same value in each process's info object.

1 *Advice to users.* Many info items that an implementation can use when it creates or
 2 opens a file cannot easily be changed once the file has been created or opened. Thus,
 3 an implementation may ignore hints issued in this call that it would have accepted in
 4 an open call. (*End of advice to users.*)

5
6
7
8 MPI_FILE_GET_INFO(fh, info_used)

9 IN fh file handle (handle)
 10 OUT info_used new info object (handle)

11
12
13 int MPI_File_get_info(MPI_File fh, MPI_Info *info_used)

14 MPI_File_get_info(fh, info_used, ierror) BIND(C)
 15 TYPE(MPI_File), INTENT(IN) :: fh
 16 TYPE(MPI_Info), INTENT(OUT) :: info_used
 17 INTEGER, OPTIONAL, INTENT(OUT) :: ierror

18 MPI_FILE_GET_INFO(FH, INFO_USED, IERROR)
 19 INTEGER FH, INFO_USED, IERROR

20
21 {MPI::Info MPI::File::Get_info() const(*binding deprecated, see Section 15.2*) }

22
23 MPI_FILE_GET_INFO returns a new info object containing the hints of the file associ-
 24 ated with fh. The current setting of all hints actually used by the system related to this open
 25 file is returned in info_used. If no such hints exist, a handle to a newly created info object
 26 is returned that contains no key/value pair. The user is responsible for freeing info_used
 27 via MPI_INFO_FREE.

28
29 *Advice to users.* The info object returned in info_used will contain all hints currently
 30 active for this file. This set of hints may be greater or smaller than the set of hints
 31 passed in to MPI_FILE_OPEN, MPI_FILE_SET_VIEW, and MPI_FILE_SET_INFO, as
 32 the system may not recognize some hints set by the user, and may recognize other
 33 hints that the user has not set. (*End of advice to users.*)

34 Reserved File Hints

35
36 Some potentially useful hints (info key values) are outlined below. The following key values
 37 are reserved. An implementation is not required to interpret these key values, but if it does
 38 interpret the key value, it must provide the functionality described. (For more details on
 39 “info,” see Section 9, page 385.)

40 These hints mainly affect access patterns and the layout of data on parallel I/O devices.
 41 For each hint name introduced, we describe the purpose of the hint, and the type of the hint
 42 value. The “[SAME]” annotation specifies that the hint values provided by all participating
 43 processes must be identical; otherwise the program is erroneous. In addition, some hints are
 44 context dependent, and are only used by an implementation at specific times (e.g., file_perm
 45 is only useful during file creation).

46
47 **access_style (comma separated list of strings):** This hint specifies the manner in which
 48 the file will be accessed until the file is closed or until the access_style key value is

- altered. The hint value is a comma separated list of the following: `read_once`, `write_once`, `read_mostly`, `write_mostly`, `sequential`, `reverse_sequential`, and `random`.
- `collective_buffering` (**boolean**) [**SAME**]: This hint specifies whether the application may benefit from collective buffering. Collective buffering is an optimization performed on collective accesses. Accesses to the file are performed on behalf of all processes in the group by a number of target nodes. These target nodes coalesce small requests into large disk accesses. Valid values for this key are `true` and `false`. Collective buffering parameters are further directed via additional hints: `cb_block_size`, `cb_buffer_size`, and `cb_nodes`.
- `cb_block_size` (**integer**) [**SAME**]: This hint specifies the block size to be used for collective buffering file access. *Target nodes* access data in chunks of this size. The chunks are distributed among target nodes in a round-robin (CYCLIC) pattern.
- `cb_buffer_size` (**integer**) [**SAME**]: This hint specifies the total buffer space that can be used for collective buffering on each target node, usually a multiple of `cb_block_size`.
- `cb_nodes` (**integer**) [**SAME**]: This hint specifies the number of target nodes to be used for collective buffering.
- `chunked` (**comma separated list of integers**) [**SAME**]: This hint specifies that the file consists of a multidimensional array that is often accessed by subarrays. The value for this hint is a comma separated list of array dimensions, starting from the most significant one (for an array stored in row-major order, as in C, the most significant dimension is the first one; for an array stored in column-major order, as in Fortran, the most significant dimension is the last one, and array dimensions should be reversed).
- `chunked_item` (**comma separated list of integers**) [**SAME**]: This hint specifies the size of each array entry, in bytes.
- `chunked_size` (**comma separated list of integers**) [**SAME**]: This hint specifies the dimensions of the subarrays. This is a comma separated list of array dimensions, starting from the most significant one.
- `filename` (**string**): This hint specifies the file name used when the file was opened. If the implementation is capable of returning the file name of an open file, it will be returned using this key by `MPI_FILE_GET_INFO`. This key is ignored when passed to `MPI_FILE_OPEN`, `MPI_FILE_SET_VIEW`, `MPI_FILE_SET_INFO`, and `MPI_FILE_DELETE`.
- `file_perm` (**string**) [**SAME**]: This hint specifies the file permissions to use for file creation. Setting this hint is only useful when passed to `MPI_FILE_OPEN` with an `amode` that includes `MPI_MODE_CREATE`. The set of valid values for this key is implementation dependent.
- `io_node_list` (**comma separated list of strings**) [**SAME**]: This hint specifies the list of I/O devices that should be used to store the file. This hint is most relevant when the file is created.
- `nb_proc` (**integer**) [**SAME**]: This hint specifies the number of parallel processes that will typically be assigned to run programs that access this file. This hint is most relevant when the file is created.

1 num_io_nodes (**integer**) [**SAME**]: This hint specifies the number of I/O devices in the
 2 system. This hint is most relevant when the file is created.

3
 4 striping_factor (**integer**) [**SAME**]: This hint specifies the number of I/O devices that the
 5 file should be striped across, and is relevant only when the file is created.

6
 7 striping_unit (**integer**) [**SAME**]: This hint specifies the suggested striping unit to be used
 8 for this file. The striping unit is the amount of consecutive data assigned to one I/O
 9 device before progressing to the next device, when striping across a number of devices.
 10 It is expressed in bytes. This hint is relevant only when the file is created.

11 13.3 File Views

12
 13
 14
 15 MPI_FILE_SET_VIEW(fh, disp, etype, filetype, datarep, info)

16	INOUT	fh	file handle (handle)
17	IN	disp	displacement (integer)
18	IN	etype	elementary datatype (handle)
19	IN	filetype	filetype (handle)
20	IN	datarep	data representation (string)
21	IN	info	info object (handle)

22
 23
 24
 25
 26 int MPI_File_set_view(MPI_File fh, MPI_Offset disp, MPI_Datatype etype,
 27 MPI_Datatype filetype, **const** char *datarep, MPI_Info info)

28
 29 MPI_File_set_view(fh, disp, etype, filetype, datarep, info, ierror) BIND(C)
 30 TYPE(MPI_File), INTENT(IN) :: fh
 31 INTEGER(KIND=MPI_OFFSET_KIND), INTENT(IN) :: disp
 32 TYPE(MPI_Datatype), INTENT(IN) :: etype, filetype
 33 CHARACTER(LEN=*), INTENT(IN) :: datarep
 34 TYPE(MPI_Info), INTENT(IN) :: info
 35 INTEGER, OPTIONAL, INTENT(OUT) :: ierror

36 MPI_FILE_SET_VIEW(FH, DISP, ETYPE, FILETYPE, DATAREP, INFO, IERROR)
 37 INTEGER FH, ETYPE, FILETYPE, INFO, IERROR
 38 CHARACTER*(*) DATAREP
 39 INTEGER(KIND=MPI_OFFSET_KIND) DISP

40 {void MPI::File::Set_view(MPI::Offset disp, const MPI::Datatype& etype,
 41 const MPI::Datatype& filetype, const char* datarep,
 42 const MPI::Info& info) (*binding deprecated, see Section 15.2*) }

43
 44 The MPI_FILE_SET_VIEW routine changes the process's view of the data in the file.
 45 The start of the view is set to disp; the type of data is set to etype; the distribution of data
 46 to processes is set to filetype; and the representation of data in the file is set to datarep.
 47 In addition, MPI_FILE_SET_VIEW resets the individual file pointers and the shared file
 48 pointer to zero. MPI_FILE_SET_VIEW is collective; the values for datarep and the extents

of `etype` in the file data representation must be identical on all processes in the group; values for `disp`, `filetype`, and `info` may vary. The datatypes passed in `etype` and `filetype` must be committed.

The `etype` always specifies the data layout in the file. If `etype` is a portable datatype (see Section 2.4, page 11), the extent of `etype` is computed by scaling any displacements in the datatype to match the file data representation. If `etype` is not a portable datatype, no scaling is done when computing the extent of `etype`. The user must be careful when using nonportable `etypes` in heterogeneous environments; see Section 13.5.1, page 560 for further details.

If `MPI_MODE_SEQUENTIAL` mode was specified when the file was opened, the special displacement `MPI_DISPLACEMENT_CURRENT` must be passed in `disp`. This sets the displacement to the current position of the shared file pointer. `MPI_DISPLACEMENT_CURRENT` is invalid unless the `amode` for the file has `MPI_MODE_SEQUENTIAL` set.

Rationale. For some sequential files, such as those corresponding to magnetic tapes or streaming network connections, the *displacement* may not be meaningful. `MPI_DISPLACEMENT_CURRENT` allows the view to be changed for these types of files. (*End of rationale.*)

Advice to implementors. It is expected that a call to `MPI_FILE_SET_VIEW` will immediately follow `MPI_FILE_OPEN` in numerous instances. A high-quality implementation will ensure that this behavior is efficient. (*End of advice to implementors.*)

The `disp` displacement argument specifies the position (absolute offset in bytes from the beginning of the file) where the view begins.

Advice to users. `disp` can be used to skip headers or when the file includes a sequence of data segments that are to be accessed in different patterns (see Figure 13.3). Separate views, each using a different displacement and `filetype`, can be used to access each segment.

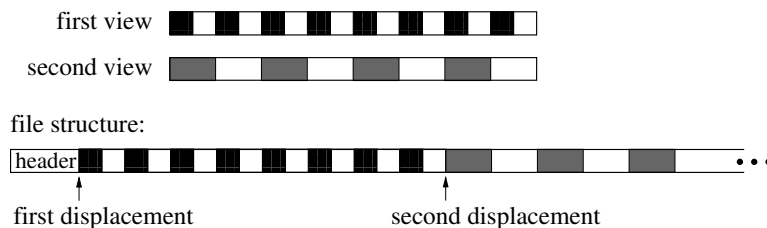

Figure 13.3: Displacements

(*End of advice to users.*)

An *etype* (*elementary* datatype) is the unit of data access and positioning. It can be any MPI predefined or derived datatype. Derived `etypes` can be constructed by using any of the MPI datatype constructor routines, provided all resulting typemap displacements are non-negative and monotonically nondecreasing. Data access is performed in `etype` units, reading or writing whole data items of type `etype`. Offsets are expressed as a count of `etypes`; file pointers point to the beginning of `etypes`.

1 *Advice to users.* In order to ensure interoperability in a heterogeneous environment,
 2 additional restrictions must be observed when constructing the `etype` (see Section 13.5,
 3 page 558). (*End of advice to users.*)
 4

5 A filetype is either a single etype or a derived MPI datatype constructed from multiple
 6 instances of the same etype. In addition, the extent of any hole in the filetype must be
 7 a multiple of the etype’s extent. These displacements are not required to be distinct, but
 8 they cannot be negative, and they must be monotonically nondecreasing.

9 If the file is opened for writing, neither the `etype` nor the `filetype` is permitted to contain
 10 overlapping regions. This restriction is equivalent to the “datatype used in a receive cannot
 11 specify overlapping regions” restriction for communication. Note that `filetypes` from different
 12 processes may still overlap each other.

13 If filetype has holes in it, then the data in the holes is inaccessible to the calling process.
 14 However, the `disp`, `etype` and `filetype` arguments can be changed via future calls to
 15 `MPI_FILE_SET_VIEW` to access a different part of the file.

16 It is erroneous to use absolute addresses in the construction of the `etype` and `filetype`.

17 The `info` argument is used to provide information regarding file access patterns and
 18 file system specifics to direct optimization (see Section 13.2.8, page 523). The constant
 19 `MPI_INFO_NULL` refers to the null info and can be used when no info needs to be specified.

20 The `datarep` argument is a string that specifies the representation of data in the file.
 21 See the file interoperability section (Section 13.5, page 558) for details and a discussion of
 22 valid values.

23 The user is responsible for ensuring that all nonblocking requests and split collective
 24 operations on `fh` have been completed before calling `MPI_FILE_SET_VIEW`—otherwise, the
 25 call to `MPI_FILE_SET_VIEW` is erroneous.
 26

27
 28 `MPI_FILE_GET_VIEW(fh, disp, etype, filetype, datarep)`

29	IN	<code>fh</code>	file handle (handle)
30	OUT	<code>disp</code>	displacement (integer)
31	OUT	<code>etype</code>	elementary datatype (handle)
32	OUT	<code>filetype</code>	filetype (handle)
33	OUT	<code>datarep</code>	data representation (string)

34
 35
 36
 37 `int MPI_File_get_view(MPI_File fh, MPI_Offset *disp, MPI_Datatype *etype,
 38 MPI_Datatype *filetype, char *datarep)`

ticket229.2.
 ticket-248T. 39 `MPI_File_get_view(fh, disp, etype, filetype, datarep, ierror) BIND(C)`
 40 `TYPE(MPI_File), INTENT(IN) :: fh`
 41 `INTEGER(KIND=MPI_OFFSET_KIND), INTENT(OUT) :: disp`
 42 `TYPE(MPI_Datatype), INTENT(OUT) :: etype, filetype`
 43 `CHARACTER(LEN=*), INTENT(OUT) :: datarep`
 44 `INTEGER, OPTIONAL, INTENT(OUT) :: ierror`
 45

46 `MPI_FILE_GET_VIEW(FH, DISP, ETYPE, FILETYPE, DATAREP, IERROR)`
 47 `INTEGER FH, ETYPE, FILETYPE, IERROR`
 48 `CHARACTER*(*) DATAREP`

```

INTEGER(KIND=MPI_OFFSET_KIND) DISP
{void MPI::File::Get_view(MPI::Offset& disp, MPI::Datatype& etype,
    MPI::Datatype& filetype, char* datarep) const(binding deprecated,
    see Section 15.2) }

```

MPI_FILE_GET_VIEW returns the process's view of the data in the file. The current value of the displacement is returned in `disp`. The `etype` and `filetype` are new datatypes with typemaps equal to the typemaps of the current `etype` and `filetype`, respectively.

The data representation is returned in `datarep`. The user is responsible for ensuring that `datarep` is large enough to hold the returned data representation string. The length of a data representation string is limited to the value of `MPI_MAX_DATAREP_STRING`.

In addition, if a portable datatype was used to set the current view, then the corresponding datatype returned by `MPI_FILE_GET_VIEW` is also a portable datatype. If `etype` or `filetype` are derived datatypes, the user is responsible for freeing them. The `etype` and `filetype` returned are both in a committed state.

13.4 Data Access

13.4.1 Data Access Routines

Data is moved between files and processes by issuing read and write calls. There are three orthogonal aspects to data access: positioning (explicit offset *vs.* implicit file pointer), synchronism (blocking *vs.* nonblocking and split collective), and coordination (noncollective *vs.* collective). The following combinations of these data access routines, including two types of file pointers (individual and shared) are provided in Table 13.1.

positioning	synchronism	coordination	
		<i>noncollective</i>	<i>collective</i>
<i>explicit offsets</i>	<i>blocking</i>	MPI_FILE_READ_AT MPI_FILE_WRITE_AT	MPI_FILE_READ_AT_ALL MPI_FILE_WRITE_AT_ALL
	<i>nonblocking & split collective</i>	MPI_FILE_IREAD_AT MPI_FILE_IWRITE_AT	MPI_FILE_READ_AT_ALL_BEGIN MPI_FILE_READ_AT_ALL_END MPI_FILE_WRITE_AT_ALL_BEGIN MPI_FILE_WRITE_AT_ALL_END
<i>individual file pointers</i>	<i>blocking</i>	MPI_FILE_READ MPI_FILE_WRITE	MPI_FILE_READ_ALL MPI_FILE_WRITE_ALL
	<i>nonblocking & split collective</i>	MPI_FILE_IREAD MPI_FILE_IWRITE	MPI_FILE_READ_ALL_BEGIN MPI_FILE_READ_ALL_END MPI_FILE_WRITE_ALL_BEGIN MPI_FILE_WRITE_ALL_END
<i>shared file pointer</i>	<i>blocking</i>	MPI_FILE_READ_SHARED MPI_FILE_WRITE_SHARED	MPI_FILE_READ_ORDERED MPI_FILE_WRITE_ORDERED
	<i>nonblocking & split collective</i>	MPI_FILE_IREAD_SHARED MPI_FILE_IWRITE_SHARED	MPI_FILE_READ_ORDERED_BEGIN MPI_FILE_READ_ORDERED_END MPI_FILE_WRITE_ORDERED_BEGIN MPI_FILE_WRITE_ORDERED_END

Table 13.1: Data access routines

POSIX `read()/pread()` and `write()/fwrite()` are blocking, noncollective operations and

1 use individual file pointers. The MPI equivalents are `MPI_FILE_READ` and
 2 `MPI_FILE_WRITE`.

3 Implementations of data access routines may buffer data to improve performance. This
 4 does not affect reads, as the data is always available in the user’s buffer after a read operation
 5 completes. For writes, however, the `MPI_FILE_SYNC` routine provides the only guarantee
 6 that data has been transferred to the storage device.

8 Positioning

9 MPI provides three types of positioning for data access routines: explicit offsets, individual
 10 file pointers, and shared file pointers. The different positioning methods may be mixed
 11 within the same program and do not affect each other.

12 The data access routines that accept explicit offsets contain `_AT` in their name (e.g.,
 13 `MPI_FILE_WRITE_AT`). Explicit offset operations perform data access at the file position
 14 given directly as an argument—no file pointer is used nor updated. Note that this is not
 15 equivalent to an atomic seek-and-read or seek-and-write operation, as no “seek” is issued.
 16 Operations with explicit offsets are described in Section 13.4.2, page 532.

17 The names of the individual file pointer routines contain no positional qualifier (e.g.,
 18 `MPI_FILE_WRITE`). Operations with individual file pointers are described in Section 13.4.3,
 19 page 536. The data access routines that use shared file pointers contain `_SHARED` or
 20 `_ORDERED` in their name (e.g., `MPI_FILE_WRITE_SHARED`). Operations with shared file
 21 pointers are described in Section 13.4.4, page 544.

22 The main semantic issues with MPI-maintained file pointers are how and when they are
 23 updated by I/O operations. In general, each I/O operation leaves the file pointer pointing to
 24 the next data item after the last one that is accessed by the operation. In a nonblocking or
 25 split collective operation, the pointer is updated by the call that initiates the I/O, possibly
 26 before the access completes.

27 More formally,

$$28 \quad new_file_offset = old_file_offset + \frac{elements(datatype)}{elements(etype)} \times count$$

29 where *count* is the number of *datatype* items to be accessed, *elements(X)* is the number of
 30 predefined datatypes in the typemap of *X*, and *old_file_offset* is the value of the implicit
 31 offset before the call. The file position, *new_file_offset*, is in terms of a count of etypes
 32 relative to the current view.

36 Synchronism

37 MPI supports blocking and nonblocking I/O routines.

38 A *blocking* I/O call will not return until the I/O request is completed.

39 A *nonblocking* I/O call initiates an I/O operation, but does not wait for it to complete.
 40 Given suitable hardware, this allows the transfer of data out/in the user’s buffer to proceed
 41 concurrently with computation. A separate *request complete* call (`MPI_WAIT`, `MPI_TEST`,
 42 or any of their variants) is needed to complete the I/O request, i.e., to confirm that the data
 43 has been read or written and that it is safe for the user to reuse the buffer. The nonblocking
 44 versions of the routines are named `MPI_FILE_IXXX`, where the *I* stands for immediate.

45 It is erroneous to access the local buffer of a nonblocking data access operation, or to
 46 use that buffer as the source or target of other communications, between the initiation and
 47 completion of the operation.

The split collective routines support a restricted form of “nonblocking” operations for collective data access (see Section 13.4.5, page 550).

Coordination

Every noncollective data access routine `MPI_FILE_XXX` has a collective counterpart. For most routines, this counterpart is `MPI_FILE_XXX_ALL` or a pair of `MPI_FILE_XXX_BEGIN` and `MPI_FILE_XXX_END`. The counterparts to the `MPI_FILE_XXX_SHARED` routines are `MPI_FILE_XXX_ORDERED`.

The completion of a noncollective call only depends on the activity of the calling process. However, the completion of a collective call (which must be called by all members of the process group) may depend on the activity of the other processes participating in the collective call. See Section 13.6.4, page 572, for rules on semantics of collective calls.

Collective operations may perform much better than their noncollective counterparts, as global data accesses have significant potential for automatic optimization.

Data Access Conventions

Data is moved between files and processes by calling read and write routines. Read routines move data from a file into memory. Write routines move data from memory into a file. The file is designated by a file handle, `fh`. The location of the file data is specified by an offset into the current view. The data in memory is specified by a triple: `buf`, `count`, and `datatype`. Upon completion, the amount of data accessed by the calling process is returned in a `status`.

An offset designates the starting position in the file for an access. The offset is always in `etype` units relative to the current view. Explicit offset routines pass `offset` as an argument (negative values are erroneous). The file pointer routines use implicit offsets maintained by MPI.

A data access routine attempts to transfer (read or write) `count` data items of type `datatype` between the user’s buffer `buf` and the file. The `datatype` passed to the routine must be a committed `datatype`. The layout of data in memory corresponding to `buf`, `count`, `datatype` is interpreted the same way as in MPI communication functions; see Section 3.2.2 on page 29 and Section 4.1.11 on page 119. The data is accessed from those parts of the file specified by the current view (Section 13.3, page 526). The type signature of `datatype` must match the type signature of some number of contiguous copies of the `etype` of the current view. As in a receive, it is erroneous to specify a `datatype` for reading that contains overlapping regions (areas of memory which would be stored into more than once).

The nonblocking data access routines indicate that MPI can start a data access and associate a request handle, `request`, with the I/O operation. Nonblocking operations are completed via `MPI_TEST`, `MPI_WAIT`, or any of their variants.

Data access operations, when completed, return the amount of data accessed in `status`.

Advice to users. To prevent problems with the argument copying and register optimization done by Fortran compilers, please note the hints in — [subsections “Problems Due to Data Copying and Sequence Association,” and “A Problem with Register Optimization” in Section 16.2.16, pages 675 and 681. subsections “Problems Due to]Sections 16.2.10-16.2.20, especially in Sections 16.2.12 and 16.2.13 on pages 675-678 about “Problems Due to Data Copying and Sequence Association with Subscript Triplets” and “Vector Subscripts”, and in Sections 16.2.16 to 16.2.19 on pages 681 to 692 about

1
2
3
4
5
6
7
8
9
10
11
12
13
14
15
16
17
18
19
20
21
22
23
24
25
26
27
28
29
30
31
32
33
34
35
36
37
38
39
40
41
42 ticket238-J.
43
44
45 ticket238-J.
46 ticket236-H.
47 ticket238-J.
48

1 “Optimization Problems”, “Code Movements and Register Optimization”, “Temporary
2 Data Movements” and “Permanent Data Movements”. (*End of advice to users.*)

3
4 For blocking routines, `status` is returned directly. For nonblocking routines and split
5 collective routines, `status` is returned when the operation is completed. The number of
6 `datatype` entries and predefined elements accessed by the calling process can be extracted
7 from `status` by using `MPI_GET_COUNT` and `MPI_GET_ELEMENTS`, respectively. The inter-
8 pretation of the `MPI_ERROR` field is the same as for other operations — normally undefined,
9 but meaningful if an MPI routine returns `MPI_ERR_IN_STATUS`. The user can pass (in C
10 and Fortran) `MPI_STATUS_IGNORE` in the `status` argument if the return value of this argu-
11 ment is not needed. In C++, the `status` argument is optional. The `status` can be passed
12 to `MPI_TEST_CANCELLED` to determine if the operation was cancelled. All other fields of
13 `status` are undefined.

14 When reading, a program can detect the end of file by noting that the amount of data
15 read is less than the amount requested. Writing past the end of file increases the file size.
16 The amount of data accessed will be the amount requested, unless an error is raised (or a
17 read reaches the end of file).

19 13.4.2 Data Access with Explicit Offsets

20 If `MPI_MODE_SEQUENTIAL` mode was specified when the file was opened, it is erroneous to
21 call the routines in this section.
22

24 MPI_FILE_READ_AT(fh, offset, buf, count, datatype, status)

25	IN	fh	file handle (handle)
26	IN	offset	file offset (integer)
27	IN	offset	file offset (integer)
28	OUT	buf	initial address of buffer (choice)
29	IN	count	number of elements in buffer (integer)
30	IN	count	number of elements in buffer (integer)
31	IN	datatype	datatype of each buffer element (handle)
32	OUT	status	status object (Status)
33	OUT	status	status object (Status)

34
35 int MPI_File_read_at(MPI_File fh, MPI_Offset offset, void *buf, int count,
36 MPI_Datatype datatype, MPI_Status *status)

ticket-248T. 37 MPI_File_read_at(fh, offset, buf, count, datatype, status, ierror) BIND(C)
38 TYPE(MPI_File), INTENT(IN) :: fh
39 INTEGER(KIND=MPI_OFFSET_KIND), INTENT(IN) :: offset
40 TYPE(*), DIMENSION(..) :: buf
41 INTEGER, INTENT(IN) :: count
42 TYPE(MPI_Datatype), INTENT(IN) :: datatype
43 TYPE(MPI_Status) :: status
44 INTEGER, OPTIONAL, INTENT(OUT) :: ierror

45
46 MPI_FILE_READ_AT(FH, OFFSET, BUF, COUNT, DATATYPE, STATUS, IERROR)
47 <type> BUF(*)
48 INTEGER FH, COUNT, DATATYPE, STATUS(MPI_STATUS_SIZE), IERROR

```

    INTEGER(KIND=MPI_OFFSET_KIND) OFFSET
{void MPI::File::Read_at(MPI::Offset offset, void* buf, int count,
    const MPI::Datatype& datatype, MPI::Status& status) (binding
    deprecated, see Section 15.2) }
{void MPI::File::Read_at(MPI::Offset offset, void* buf, int count,
    const MPI::Datatype& datatype) (binding deprecated, see Section 15.2)
}
```

MPI_FILE_READ_AT reads a file beginning at the position specified by offset.

MPI_FILE_READ_AT_ALL(fh, offset, buf, count, datatype, status)

IN	fh	file handle (handle)
IN	offset	file offset (integer)
OUT	buf	initial address of buffer (choice)
IN	count	number of elements in buffer (integer)
IN	datatype	datatype of each buffer element (handle)
OUT	status	status object (Status)

```
int MPI_File_read_at_all(MPI_File fh, MPI_Offset offset, void *buf,
    int count, MPI_Datatype datatype, MPI_Status *status)
```

MPI_File_read_at_all(fh, offset, buf, count, datatype, status, ierror)

```

    BIND(C)
    TYPE(MPI_File), INTENT(IN) :: fh
    INTEGER(KIND=MPI_OFFSET_KIND), INTENT(IN) :: offset
    TYPE(*), DIMENSION(..) :: buf
    INTEGER, INTENT(IN) :: count
    TYPE(MPI_Datatype), INTENT(IN) :: datatype
    TYPE(MPI_Status) :: status
    INTEGER, OPTIONAL, INTENT(OUT) :: ierror
```

MPI_FILE_READ_AT_ALL(FH, OFFSET, BUF, COUNT, DATATYPE, STATUS, IERROR)

```

<type> BUF(*)
    INTEGER FH, COUNT, DATATYPE, STATUS(MPI_STATUS_SIZE), IERROR
    INTEGER(KIND=MPI_OFFSET_KIND) OFFSET
```

```

{void MPI::File::Read_at_all(MPI::Offset offset, void* buf, int count,
    const MPI::Datatype& datatype, MPI::Status& status) (binding
    deprecated, see Section 15.2) }
```

```

{void MPI::File::Read_at_all(MPI::Offset offset, void* buf, int count,
    const MPI::Datatype& datatype) (binding deprecated, see Section 15.2)
}
```

MPI_FILE_READ_AT_ALL is a collective version of the blocking MPI_FILE_READ_AT interface.

```
1 MPI_FILE_WRITE_AT(fh, offset, buf, count, datatype, status)
```

```
2     INOUT   fh                file handle (handle)
3
4     IN     offset            file offset (integer)
5
6     IN     buf               initial address of buffer (choice)
7
8     IN     count             number of elements in buffer (integer)
9
10    IN     datatype           datatype of each buffer element (handle)
11
12    OUT    status             status object (Status)
```

```
ticket140. 11 int MPI_File_write_at(MPI_File fh, MPI_Offset offset, const void *buf,
12                  int count, MPI_Datatype datatype, MPI_Status *status)
```

```
ticket-248T. 13 MPI_File_write_at(fh, offset, buf, count, datatype, status, ierror) BIND(C)
14     TYPE(MPI_File), INTENT(IN) :: fh
15     INTEGER(KIND=MPI_OFFSET_KIND), INTENT(IN) :: offset
16     TYPE(*), DIMENSION(..), INTENT(IN) :: buf
17     INTEGER, INTENT(IN) :: count
18     TYPE(MPI_Datatype), INTENT(IN) :: datatype
19     TYPE(MPI_Status) :: status
20     INTEGER, OPTIONAL, INTENT(OUT) :: ierror
```

```
22 MPI_FILE_WRITE_AT(FH, OFFSET, BUF, COUNT, DATATYPE, STATUS, IERROR)
23     <type> BUF(*)
24     INTEGER FH, COUNT, DATATYPE, STATUS(MPI_STATUS_SIZE), IERROR
25     INTEGER(KIND=MPI_OFFSET_KIND) OFFSET
```

```
27 {void MPI::File::Write_at(MPI::Offset offset, const void* buf, int count,
28     const MPI::Datatype& datatype, MPI::Status& status) (binding
29     deprecated, see Section 15.2) }
```

```
30 {void MPI::File::Write_at(MPI::Offset offset, const void* buf, int count,
31     const MPI::Datatype& datatype) (binding deprecated, see Section 15.2)
32     }
```

34 MPI_FILE_WRITE_AT writes a file beginning at the position specified by offset.

```
36 MPI_FILE_WRITE_AT_ALL(fh, offset, buf, count, datatype, status)
```

```
38     INOUT   fh                file handle (handle)
39
40     IN     offset            file offset (integer)
41
42     IN     buf               initial address of buffer (choice)
43
44     IN     count             number of elements in buffer (integer)
45
46     IN     datatype           datatype of each buffer element (handle)
47
48     OUT    status             status object (Status)
```

```
ticket140. 47 int MPI_File_write_at_all(MPI_File fh, MPI_Offset offset, const void *buf,
48                  int count, MPI_Datatype datatype, MPI_Status *status)
```

ticket229.1.
ticket-248T.

```

1
2 MPI_File_write_at_all(fh, offset, buf, count, datatype, status, ierror)
3     BIND(C)
4     TYPE(MPI_File), INTENT(IN) :: fh
5     INTEGER(KIND=MPI_OFFSET_KIND), INTENT(IN) :: offset
6     TYPE(*), DIMENSION(..), INTENT(IN) :: buf
7     INTEGER, INTENT(IN) :: count
8     TYPE(MPI_Datatype), INTENT(IN) :: datatype
9     TYPE(MPI_Status) :: status
10    INTEGER, OPTIONAL, INTENT(OUT) :: ierror
11
12 MPI_FILE_WRITE_AT_ALL(FH, OFFSET, BUF, COUNT, DATATYPE, STATUS, IERROR)
13     <type> BUF(*)
14     INTEGER FH, COUNT, DATATYPE, STATUS(MPI_STATUS_SIZE), IERROR
15     INTEGER(KIND=MPI_OFFSET_KIND) OFFSET
16
17 {void MPI::File::Write_at_all(MPI::Offset offset, const void* buf,
18     int count, const MPI::Datatype& datatype,
19     MPI::Status& status) (binding deprecated, see Section 15.2) }
20
21 {void MPI::File::Write_at_all(MPI::Offset offset, const void* buf,
22     int count, const MPI::Datatype& datatype) (binding deprecated, see
23     Section 15.2) }
24
25 MPI_FILE_WRITE_AT_ALL is a collective version of the blocking
26 MPI_FILE_WRITE_AT interface.
27
28 MPI_FILE_IREAD_AT(fh, offset, buf, count, datatype, request)
29
30 IN     fh           file handle (handle)
31 IN     offset       file offset (integer)
32 OUT    buf          initial address of buffer (choice)
33 IN     count        number of elements in buffer (integer)
34 IN     datatype     datatype of each buffer element (handle)
35 OUT    request      request object (handle)
36
37 int MPI_File_iread_at(MPI_File fh, MPI_Offset offset, void *buf, int count,
38     MPI_Datatype datatype, MPI_Request *request)
39
40 MPI_File_iread_at(fh, offset, buf, count, datatype, request, ierror)
41     BIND(C)
42     TYPE(MPI_File), INTENT(IN) :: fh
43     INTEGER(KIND=MPI_OFFSET_KIND), INTENT(IN) :: offset
44     TYPE(*), DIMENSION(..), ASYNCHRONOUS :: buf
45     INTEGER, INTENT(IN) :: count
46     TYPE(MPI_Datatype), INTENT(IN) :: datatype
47     TYPE(MPI_Request), INTENT(OUT) :: request
48     INTEGER, OPTIONAL, INTENT(OUT) :: ierror

```

ticket-248T.

```

1 MPI_FILE_IREAD_AT(FH, OFFSET, BUF, COUNT, DATATYPE, REQUEST, IERROR)
2   <type> BUF(*)
3   INTEGER FH, COUNT, DATATYPE, REQUEST, IERROR
4   INTEGER(KIND=MPI_OFFSET_KIND) OFFSET
5
6 {MPI::Request MPI::File::Iread_at(MPI::Offset offset, void* buf, int count,
7   const MPI::Datatype& datatype) (binding deprecated, see Section 15.2)
8   }

```

MPI_FILE_IREAD_AT is a nonblocking version of the MPI_FILE_READ_AT interface.

```

11 MPI_FILE_IWRITE_AT(fh, offset, buf, count, datatype, request)
12
13 INOUT fh file handle (handle)
14 IN offset file offset (integer)
15 IN buf initial address of buffer (choice)
16 IN count number of elements in buffer (integer)
17 IN datatype datatype of each buffer element (handle)
18 IN request request object (handle)
19
20
21

```

```

ticket140. 22 int MPI_File_iwrite_at(MPI_File fh, MPI_Offset offset, const void *buf,
23   int count, MPI_Datatype datatype, MPI_Request *request)
ticket-248T. 24

```

```

25 MPI_File_iwrite_at(fh, offset, buf, count, datatype, request, ierror)
26   BIND(C)
27   TYPE(MPI_File), INTENT(IN) :: fh
28   INTEGER(KIND=MPI_OFFSET_KIND), INTENT(IN) :: offset
29   TYPE(*), DIMENSION(..), INTENT(IN), ASYNCHRONOUS :: buf
30   INTEGER, INTENT(IN) :: count
31   TYPE(MPI_Datatype), INTENT(IN) :: datatype
32   TYPE(MPI_Request), INTENT(OUT) :: request
33   INTEGER, OPTIONAL, INTENT(OUT) :: ierror

```

```

34 MPI_FILE_IWRITE_AT(FH, OFFSET, BUF, COUNT, DATATYPE, REQUEST, IERROR)
35   <type> BUF(*)
36   INTEGER FH, COUNT, DATATYPE, REQUEST, IERROR
37   INTEGER(KIND=MPI_OFFSET_KIND) OFFSET
38
39 {MPI::Request MPI::File::Iwrite_at(MPI::Offset offset, const void* buf,
40   int count, const MPI::Datatype& datatype) (binding deprecated, see
41   Section 15.2) }

```

MPI_FILE_IWRITE_AT is a nonblocking version of the MPI_FILE_WRITE_AT interface.

13.4.3 Data Access with Individual File Pointers

MPI maintains one individual file pointer per process per file handle. The current value of this pointer implicitly specifies the offset in the data access routines described in this

section. These routines only use and update the individual file pointers maintained by MPI. The shared file pointer is not used nor updated.

The individual file pointer routines have the same semantics as the data access with explicit offset routines described in Section 13.4.2, page 532, with the following modification:

- the offset is defined to be the current value of the MPI-maintained individual file pointer.

After an individual file pointer operation is initiated, the individual file pointer is updated to point to the next etype after the last one that will be accessed. The file pointer is updated relative to the current view of the file.

If MPI_MODE_SEQUENTIAL mode was specified when the file was opened, it is erroneous to call the routines in this section, with the exception of MPI_FILE_GET_BYTE_OFFSET.

MPI_FILE_READ(fh, buf, count, datatype, status)

INOUT	fh	file handle (handle)
OUT	buf	initial address of buffer (choice)
IN	count	number of elements in buffer (integer)
IN	datatype	datatype of each buffer element (handle)
OUT	status	status object (Status)

```
int MPI_File_read(MPI_File fh, void *buf, int count, MPI_Datatype datatype,
                 MPI_Status *status)
```

```
MPI_File_read(fh, buf, count, datatype, status, ierror) BIND(C)
  TYPE(MPI_File), INTENT(IN) :: fh
  TYPE(*), DIMENSION(..) :: buf
  INTEGER, INTENT(IN) :: count
  TYPE(MPI_Datatype), INTENT(IN) :: datatype
  TYPE(MPI_Status) :: status
  INTEGER, OPTIONAL, INTENT(OUT) :: ierror
```

```
MPI_FILE_READ(FH, BUF, COUNT, DATATYPE, STATUS, IERROR)
  <type> BUF(*)
  INTEGER FH, COUNT, DATATYPE, STATUS(MPI_STATUS_SIZE), IERROR
```

```
{void MPI::File::Read(void* buf, int count, const MPI::Datatype& datatype,
                     MPI::Status& status) (binding deprecated, see Section 15.2) }
```

```
{void MPI::File::Read(void* buf, int count,
                     const MPI::Datatype& datatype) (binding deprecated, see Section 15.2)
  }
```

MPI_FILE_READ reads a file using the individual file pointer.

Example 13.2 The following Fortran code fragment is an example of reading a file until the end of file is reached:

```

1  ! Read a preexisting input file until all data has been read.
2  ! Call routine "process_input" if all requested data is read.
3  ! The Fortran 90 "exit" statement exits the loop.
4
5      integer  bufsize, numread, totprocessed, status(MPI_STATUS_SIZE)
6      parameter (bufsize=100)
7      real      localbuffer(bufsize)
8      integer (kind=MPI_OFFSET_KIND) zero
9
10     zero = 0
11
12     call MPI_FILE_OPEN( MPI_COMM_WORLD, 'myoldfile', &
13                        MPI_MODE_RDONLY, MPI_INFO_NULL, myfh, ierr )
14     call MPI_FILE_SET_VIEW( myfh, zero, MPI_REAL, MPI_REAL, 'native', &
15                            MPI_INFO_NULL, ierr )
16     totprocessed = 0
17     do
18         call MPI_FILE_READ( myfh, localbuffer, bufsize, MPI_REAL, &
19                            status, ierr )
20         call MPI_GET_COUNT( status, MPI_REAL, numread, ierr )
21         call process_input( localbuffer, numread )
22         totprocessed = totprocessed + numread
23         if ( numread < bufsize ) exit
24     enddo
25
26     write(6,1001) numread, bufsize, totprocessed
27 1001 format( "No more data: read", I3, "and expected", I3, &
28            "Processed total of", I6, "before terminating job." )
29
30     call MPI_FILE_CLOSE( myfh, ierr )
31

```

```

32
33 MPI_FILE_READ_ALL(fh, buf, count, datatype, status)
34

```

35	INOUT	fh	file handle (handle)
36	OUT	buf	initial address of buffer (choice)
37			
38	IN	count	number of elements in buffer (integer)
39	IN	datatype	datatype of each buffer element (handle)
40	OUT	status	status object (Status)
41			

```

42
43 int MPI_File_read_all(MPI_File fh, void *buf, int count,
44                      MPI_Datatype datatype, MPI_Status *status)

```

```

45 MPI_File_read_all(fh, buf, count, datatype, status, ierror) BIND(C)
46 TYPE(MPI_File), INTENT(IN) :: fh
47 TYPE(*), DIMENSION(..) :: buf
48 INTEGER, INTENT(IN) :: count

```

ticket-248T.

```

    TYPE(MPI_Datatype), INTENT(IN) :: datatype
    TYPE(MPI_Status) :: status
    INTEGER, OPTIONAL, INTENT(OUT) :: ierror
MPI_FILE_READ_ALL(FH, BUF, COUNT, DATATYPE, STATUS, IERROR)
    <type> BUF(*)
    INTEGER FH, COUNT, DATATYPE, STATUS(MPI_STATUS_SIZE), IERROR
{void MPI::File::Read_all(void* buf, int count,
    const MPI::Datatype& datatype, MPI::Status& status) (binding
    deprecated, see Section 15.2) }
{void MPI::File::Read_all(void* buf, int count,
    const MPI::Datatype& datatype) (binding deprecated, see Section 15.2)
    }

```

MPI_FILE_READ_ALL is a collective version of the blocking MPI_FILE_READ interface.

MPI_FILE_WRITE(fh, buf, count, datatype, status)

INOUT	fh	file handle (handle)
IN	buf	initial address of buffer (choice)
IN	count	number of elements in buffer (integer)
IN	datatype	datatype of each buffer element (handle)
OUT	status	status object (Status)

```

int MPI_File_write(MPI_File fh, const void *buf, int count,
    MPI_Datatype datatype, MPI_Status *status)

```

```

MPI_File_write(fh, buf, count, datatype, status, ierror) BIND(C)
    TYPE(MPI_File), INTENT(IN) :: fh
    TYPE(*), DIMENSION(..), INTENT(IN) :: buf
    INTEGER, INTENT(IN) :: count
    TYPE(MPI_Datatype), INTENT(IN) :: datatype
    TYPE(MPI_Status) :: status
    INTEGER, OPTIONAL, INTENT(OUT) :: ierror

```

MPI_FILE_WRITE(FH, BUF, COUNT, DATATYPE, STATUS, IERROR)

```

    <type> BUF(*)
    INTEGER FH, COUNT, DATATYPE, STATUS(MPI_STATUS_SIZE), IERROR
{void MPI::File::Write(const void* buf, int count,
    const MPI::Datatype& datatype, MPI::Status& status) (binding
    deprecated, see Section 15.2) }
{void MPI::File::Write(const void* buf, int count,
    const MPI::Datatype& datatype) (binding deprecated, see Section 15.2)
    }

```

MPI_FILE_WRITE writes a file using the individual file pointer.

```

1 MPI_FILE_WRITE_ALL(fh, buf, count, datatype, status)
2     INOUT   fh           file handle (handle)
3
4     IN      buf          initial address of buffer (choice)
5
6     IN      count        number of elements in buffer (integer)
7
8     IN      datatype     datatype of each buffer element (handle)
9
10    OUT     status        status object (Status)

```

```

ticket140. 10 int MPI_File_write_all(MPI_File fh, const void *buf, int count,
11                    MPI_Datatype datatype, MPI_Status *status)

```

```

ticket-248T. 12 MPI_File_write_all(fh, buf, count, datatype, status, ierror) BIND(C)
13     TYPE(MPI_File), INTENT(IN) :: fh
14     TYPE(*), DIMENSION(..), INTENT(IN) :: buf
15     INTEGER, INTENT(IN) :: count
16     TYPE(MPI_Datatype), INTENT(IN) :: datatype
17     TYPE(MPI_Status) :: status
18     INTEGER, OPTIONAL, INTENT(OUT) :: ierror
19
20 MPI_FILE_WRITE_ALL(FH, BUF, COUNT, DATATYPE, STATUS, IERROR)
21     <type> BUF(*)
22     INTEGER FH, COUNT, DATATYPE, STATUS(MPI_STATUS_SIZE), IERROR
23
24 {void MPI::File::Write_all(const void* buf, int count,
25                          const MPI::Datatype& datatype, MPI::Status& status) (binding
26                          deprecated, see Section 15.2) }
27
28 {void MPI::File::Write_all(const void* buf, int count,
29                          const MPI::Datatype& datatype) (binding deprecated, see Section 15.2)
30 }

```

31 MPI_FILE_WRITE_ALL is a collective version of the blocking MPI_FILE_WRITE inter-
32 face.

```

33
34 MPI_FILE_IREAD(fh, buf, count, datatype, request)
35
36     INOUT   fh           file handle (handle)
37
38     OUT     buf          initial address of buffer (choice)
39
40     IN      count        number of elements in buffer (integer)
41
42     IN      datatype     datatype of each buffer element (handle)
43
44     OUT     request       request object (handle)

```

```

45 int MPI_File_iread(MPI_File fh, void *buf, int count,
46                 MPI_Datatype datatype, MPI_Request *request)

```

```

ticket-248T. 45 MPI_File_iread(fh, buf, count, datatype, request, ierror) BIND(C)
46     TYPE(MPI_File), INTENT(IN) :: fh
47     TYPE(*), DIMENSION(..), ASYNCHRONOUS :: buf
48

```

```

    INTEGER, INTENT(IN) :: count
    TYPE(MPI_Datatype), INTENT(IN) :: datatype
    TYPE(MPI_Request), INTENT(OUT) :: request
    INTEGER, OPTIONAL, INTENT(OUT) :: ierror
MPI_FILE_IREAD(FH, BUF, COUNT, DATATYPE, REQUEST, IERROR)
    <type> BUF(*)
    INTEGER FH, COUNT, DATATYPE, REQUEST, IERROR
{MPI::Request MPI::File::Iread(void* buf, int count,
    const MPI::Datatype& datatype) (binding deprecated, see Section 15.2)
    }

```

MPI_FILE_IREAD is a nonblocking version of the MPI_FILE_READ interface.

Example 13.3 The following Fortran code fragment illustrates file pointer update semantics:

```

! Read the first twenty real words in a file into two local
! buffers. Note that when the first MPI_FILE_IREAD returns,
! the file pointer has been updated to point to the
! eleventh real word in the file.

integer bufsize, req1, req2
integer, dimension(MPI_STATUS_SIZE) :: status1, status2
parameter (bufsize=10)
real buf1(bufsize), buf2(bufsize)
integer (kind=MPI_OFFSET_KIND) zero

zero = 0
call MPI_FILE_OPEN( MPI_COMM_WORLD, 'myoldfile', &
    MPI_MODE_RDONLY, MPI_INFO_NULL, myfh, ierr )
call MPI_FILE_SET_VIEW( myfh, zero, MPI_REAL, MPI_REAL, 'native', &
    MPI_INFO_NULL, ierr )
call MPI_FILE_IREAD( myfh, buf1, bufsize, MPI_REAL, &
    req1, ierr )
call MPI_FILE_IREAD( myfh, buf2, bufsize, MPI_REAL, &
    req2, ierr )

call MPI_WAIT( req1, status1, ierr )
call MPI_WAIT( req2, status2, ierr )

call MPI_FILE_CLOSE( myfh, ierr )

```

```

1 MPI_FILE_IWRITE(fh, buf, count, datatype, request)
2     INOUT   fh           file handle (handle)
3
4     IN      buf          initial address of buffer (choice)
5
6     IN      count        number of elements in buffer (integer)
7
8     IN      datatype     datatype of each buffer element (handle)
9
10    OUT     request      request object (handle)

```

```

ticket140. 10 int MPI_File_ fwrite(MPI_File fh, const void *buf, int count,
11                MPI_Datatype datatype, MPI_Request *request)

```

```

ticket-248T. 12 MPI_File_ fwrite(fh, buf, count, datatype, request, ierror) BIND(C)
13     TYPE(MPI_File), INTENT(IN) :: fh
14     TYPE(*), DIMENSION(..), INTENT(IN), ASYNCHRONOUS :: buf
15     INTEGER, INTENT(IN) :: count
16     TYPE(MPI_Datatype), INTENT(IN) :: datatype
17     TYPE(MPI_Request), INTENT(OUT) :: request
18     INTEGER, OPTIONAL, INTENT(OUT) :: ierror
19
20 MPI_FILE_IWRITE(FH, BUF, COUNT, DATATYPE, REQUEST, IERROR)
21     <type> BUF(*)
22     INTEGER FH, COUNT, DATATYPE, REQUEST, IERROR
23
24 {MPI::Request MPI::File::fwrite(const void* buf, int count,
25     const MPI::Datatype& datatype) (binding deprecated, see Section 15.2)
26     }

```

MPI_FILE_IWRITE is a nonblocking version of the MPI_FILE_WRITE interface.

```

29
30 MPI_FILE_SEEK(fh, offset, whence)
31     INOUT   fh           file handle (handle)
32
33     IN      offset        file offset (integer)
34
35     IN      whence        update mode (state)

```

```

36 int MPI_File_ seek(MPI_File fh, MPI_Offset offset, int whence)

```

```

ticket-248T. 37 MPI_File_ seek(fh, offset, whence, ierror) BIND(C)
38     TYPE(MPI_File), INTENT(IN) :: fh
39     INTEGER(KIND=MPI_OFFSET_KIND), INTENT(IN) :: offset
40     INTEGER, INTENT(IN) :: whence
41     INTEGER, OPTIONAL, INTENT(OUT) :: ierror
42
43 MPI_FILE_SEEK(FH, OFFSET, WHENCE, IERROR)
44     INTEGER FH, WHENCE, IERROR
45     INTEGER(KIND=MPI_OFFSET_KIND) OFFSET
46
47 {void MPI::File::Seek(MPI::Offset offset, int whence) (binding deprecated, see
48     Section 15.2) }

```

MPI_FILE_SEEK updates the individual file pointer according to whence, which has the following possible values:

- MPI_SEEK_SET: the pointer is set to offset
- MPI_SEEK_CUR: the pointer is set to the current pointer position plus offset
- MPI_SEEK_END: the pointer is set to the end of file plus offset

The offset can be negative, which allows seeking backwards. It is erroneous to seek to a negative position in the view.

MPI_FILE_GET_POSITION(fh, offset)

IN	fh	file handle (handle)
OUT	offset	offset of individual pointer (integer)

```
int MPI_File_get_position(MPI_File fh, MPI_Offset *offset)
```

```
MPI_File_get_position(fh, offset, ierror) BIND(C)
  TYPE(MPI_File), INTENT(IN) :: fh
  INTEGER(KIND=MPI_OFFSET_KIND), INTENT(OUT) :: offset
  INTEGER, OPTIONAL, INTENT(OUT) :: ierror
```

```
MPI_FILE_GET_POSITION(FH, OFFSET, IERROR)
  INTEGER FH, IERROR
  INTEGER(KIND=MPI_OFFSET_KIND) OFFSET
```

```
{MPI::Offset MPI::File::Get_position() const(binding deprecated, see Section 15.2)
}
```

MPI_FILE_GET_POSITION returns, in offset, the current position of the individual file pointer in etype units relative to the current view.

Advice to users. The offset can be used in a future call to MPI_FILE_SEEK using whence = MPI_SEEK_SET to return to the current position. To set the displacement to the current file pointer position, first convert offset into an absolute byte position using MPI_FILE_GET_BYTE_OFFSET, then call MPI_FILE_SET_VIEW with the resulting displacement. (*End of advice to users.*)

MPI_FILE_GET_BYTE_OFFSET(fh, offset, disp)

IN	fh	file handle (handle)
IN	offset	offset (integer)
OUT	disp	absolute byte position of offset (integer)

```
int MPI_File_get_byte_offset(MPI_File fh, MPI_Offset offset,
                             MPI_Offset *disp)
```

```

1 MPI_File_get_byte_offset(fh, offset, disp, ierror) BIND(C)
2   TYPE(MPI_File), INTENT(IN) :: fh
3   INTEGER(KIND=MPI_OFFSET_KIND), INTENT(IN) :: offset
4   INTEGER(KIND=MPI_OFFSET_KIND), INTENT(OUT) :: disp
5   INTEGER, OPTIONAL, INTENT(OUT) :: ierror
6
7 MPI_FILE_GET_BYTE_OFFSET(FH, OFFSET, DISP, IERROR)
8   INTEGER FH, IERROR
9   INTEGER(KIND=MPI_OFFSET_KIND) OFFSET, DISP
10 {MPI::Offset MPI::File::Get_byte_offset(const MPI::Offset disp)
11     const(binding deprecated, see Section 15.2) }
12

```

MPI_FILE_GET_BYTE_OFFSET converts a view-relative offset into an absolute byte position. The absolute byte position (from the beginning of the file) of `offset` relative to the current view of `fh` is returned in `disp`.

13.4.4 Data Access with Shared File Pointers

MPI maintains exactly one shared file pointer per collective MPI_FILE_OPEN (shared among processes in the communicator group). The current value of this pointer implicitly specifies the offset in the data access routines described in this section. These routines only use and update the shared file pointer maintained by MPI. The individual file pointers are not used nor updated.

The shared file pointer routines have the same semantics as the data access with explicit offset routines described in Section 13.4.2, page 532, with the following modifications:

- the `offset` is defined to be the current value of the MPI-maintained shared file pointer,
- the effect of multiple calls to shared file pointer routines is defined to behave as if the calls were serialized, and
- the use of shared file pointer routines is erroneous unless all processes use the same file view.

For the noncollective shared file pointer routines, the serialization ordering is not deterministic. The user needs to use other synchronization means to enforce a specific order.

After a shared file pointer operation is initiated, the shared file pointer is updated to point to the next etype after the last one that will be accessed. The file pointer is updated relative to the current view of the file.

Noncollective Operations

MPI_FILE_READ_SHARED(fh, buf, count, datatype, status)

INOUT	fh	file handle (handle)
OUT	buf	initial address of buffer (choice)
IN	count	number of elements in buffer (integer)
IN	datatype	datatype of each buffer element (handle)
OUT	status	status object (Status)

```
int MPI_File_read_shared(MPI_File fh, void *buf, int count,
                        MPI_Datatype datatype, MPI_Status *status)
```

```
MPI_File_read_shared(fh, buf, count, datatype, status, ierror) BIND(C)
    TYPE(MPI_File), INTENT(IN) :: fh
    TYPE(*), DIMENSION(..) :: buf
    INTEGER, INTENT(IN) :: count
    TYPE(MPI_Datatype), INTENT(IN) :: datatype
    TYPE(MPI_Status) :: status
    INTEGER, OPTIONAL, INTENT(OUT) :: ierror
```

```
MPI_FILE_READ_SHARED(FH, BUF, COUNT, DATATYPE, STATUS, IERROR)
    <type> BUF(*)
    INTEGER FH, COUNT, DATATYPE, STATUS(MPI_STATUS_SIZE), IERROR
```

```
{void MPI::File::Read_shared(void* buf, int count,
                             const MPI::Datatype& datatype, MPI::Status& status) (binding
                             deprecated, see Section 15.2) }
```

```
{void MPI::File::Read_shared(void* buf, int count,
                             const MPI::Datatype& datatype) (binding deprecated, see Section 15.2)
    }
```

MPI_FILE_READ_SHARED reads a file using the shared file pointer.

MPI_FILE_WRITE_SHARED(fh, buf, count, datatype, status)

INOUT	fh	file handle (handle)
IN	buf	initial address of buffer (choice)
IN	count	number of elements in buffer (integer)
IN	datatype	datatype of each buffer element (handle)
OUT	status	status object (Status)

```
int MPI_File_write_shared(MPI_File fh, const void *buf, int count,
                          MPI_Datatype datatype, MPI_Status *status)
```

```
MPI_File_write_shared(fh, buf, count, datatype, status, ierror) BIND(C)
```

```

1     TYPE(MPI_File), INTENT(IN) :: fh
2     TYPE(*), DIMENSION(..), INTENT(IN) :: buf
3     INTEGER, INTENT(IN) :: count
4     TYPE(MPI_Datatype), INTENT(IN) :: datatype
5     TYPE(MPI_Status) :: status
6     INTEGER, OPTIONAL, INTENT(OUT) :: ierror
7
8 MPI_FILE_WRITE_SHARED(FH, BUF, COUNT, DATATYPE, STATUS, IERROR)
9     <type> BUF(*)
10    INTEGER FH, COUNT, DATATYPE, STATUS(MPI_STATUS_SIZE), IERROR
11    {void MPI::File::Write_shared(const void* buf, int count,
12        const MPI::Datatype& datatype, MPI::Status& status) (binding
13        deprecated, see Section 15.2) }
14
15    {void MPI::File::Write_shared(const void* buf, int count,
16        const MPI::Datatype& datatype) (binding deprecated, see Section 15.2)
17        }

```

MPI_FILE_WRITE_SHARED writes a file using the shared file pointer.

```

20
21 MPI_FILE_IREAD_SHARED(fh, buf, count, datatype, request)
22
23     INOUT   fh                file handle (handle)
24     OUT     buf                initial address of buffer (choice)
25     IN      count              number of elements in buffer (integer)
26     IN      datatype           datatype of each buffer element (handle)
27     OUT     request            request object (handle)

```

```

28
29
30 int MPI_File_iread_shared(MPI_File fh, void *buf, int count,
31     MPI_Datatype datatype, MPI_Request *request)

```

ticket-248T.

```

32 MPI_File_iread_shared(fh, buf, count, datatype, request, ierror) BIND(C)
33     TYPE(MPI_File), INTENT(IN) :: fh
34     TYPE(*), DIMENSION(..), ASYNCHRONOUS :: buf
35     INTEGER, INTENT(IN) :: count
36     TYPE(MPI_Datatype), INTENT(IN) :: datatype
37     TYPE(MPI_Request), INTENT(OUT) :: request
38     INTEGER, OPTIONAL, INTENT(OUT) :: ierror
39

```

```

40 MPI_FILE_IREAD_SHARED(FH, BUF, COUNT, DATATYPE, REQUEST, IERROR)
41     <type> BUF(*)
42     INTEGER FH, COUNT, DATATYPE, REQUEST, IERROR

```

```

43 {MPI::Request MPI::File::Iread_shared(void* buf, int count,
44     const MPI::Datatype& datatype) (binding deprecated, see Section 15.2)
45     }

```

MPI_FILE_IREAD_SHARED is a nonblocking version of the MPI_FILE_READ_SHARED interface.

```

MPI_FILE_IWRITE_SHARED(fh, buf, count, datatype, request) 1
    INOUT fh file handle (handle) 2
    IN buf initial address of buffer (choice) 3
    IN count number of elements in buffer (integer) 4
    IN datatype datatype of each buffer element (handle) 5
    OUT request request object (handle) 6
    7
    8
    9
int MPI_File_iformat_shared(MPI_File fh, const void *buf, int count, 10 ticket140.
    MPI_Datatype datatype, MPI_Request *request) 11
MPI_File_iformat_shared(fh, buf, count, datatype, request, ierror) BIND(C) 12 ticket229.1.
    TYPE(MPI_File), INTENT(IN) :: fh 13 ticket-248T.
    TYPE(*), DIMENSION(..), INTENT(IN), ASYNCHRONOUS :: buf 14
    INTEGER, INTENT(IN) :: count 15
    TYPE(MPI_Datatype), INTENT(IN) :: datatype 16
    TYPE(MPI_Request), INTENT(OUT) :: request 17
    INTEGER, OPTIONAL, INTENT(OUT) :: ierror 18
MPI_FILE_IWRITE_SHARED(FH, BUF, COUNT, DATATYPE, REQUEST, IERROR) 19
    <type> BUF(*) 20
    INTEGER FH, COUNT, DATATYPE, REQUEST, IERROR 21
{MPI::Request MPI::File::Iwrite_shared(const void* buf, int count, 22
    const MPI::Datatype& datatype) (binding deprecated, see Section 15.2) 23
    } 24
} 25

```

MPI_FILE_IWRITE_SHARED is a nonblocking version of the MPI_FILE_WRITE_SHARED interface.

Collective Operations

The semantics of a collective access using a shared file pointer is that the accesses to the file will be in the order determined by the ranks of the processes within the group. For each process, the location in the file at which data is accessed is the position at which the shared file pointer would be after all processes whose ranks within the group less than that of this process had accessed their data. In addition, in order to prevent subsequent shared offset accesses by the same processes from interfering with this collective access, the call might return only after all the processes within the group have initiated their accesses. When the call returns, the shared file pointer points to the next etype accessible, according to the file view used by all processes, after the last etype requested.

Advice to users. There may be some programs in which all processes in the group need to access the file using the shared file pointer, but the program may not require that data be accessed in order of process rank. In such programs, using the shared ordered routines (e.g., MPI_FILE_WRITE_ORDERED rather than MPI_FILE_WRITE_SHARED) may enable an implementation to optimize access, improving performance. (*End of advice to users.*)

1 *Advice to implementors.* Accesses to the data requested by all processes do not have
 2 to be serialized. Once all processes have issued their requests, locations within the file
 3 for all accesses can be computed, and accesses can proceed independently from each
 4 other, possibly in parallel. (*End of advice to implementors.*)

7 MPI_FILE_READ_ORDERED(fh, buf, count, datatype, status)

8
 9 INOUT fh file handle (handle)
 10 OUT buf initial address of buffer (choice)
 11 IN count number of elements in buffer (integer)
 12 IN datatype datatype of each buffer element (handle)
 13
 14 OUT status status object (Status)

15
 16 int MPI_File_read_ordered(MPI_File fh, void *buf, int count,
 17 MPI_Datatype datatype, MPI_Status *status)

ticket-248T. 18 MPI_File_read_ordered(fh, buf, count, datatype, status, ierror) BIND(C)
 19 TYPE(MPI_File), INTENT(IN) :: fh
 20 TYPE(*), DIMENSION(..) :: buf
 21 INTEGER, INTENT(IN) :: count
 22 TYPE(MPI_Datatype), INTENT(IN) :: datatype
 23 TYPE(MPI_Status) :: status
 24 INTEGER, OPTIONAL, INTENT(OUT) :: ierror

25
 26 MPI_FILE_READ_ORDERED(FH, BUF, COUNT, DATATYPE, STATUS, IERROR)
 27 <type> BUF(*)
 28 INTEGER FH, COUNT, DATATYPE, STATUS(MPI_STATUS_SIZE), IERROR

29 {void MPI::File::Read_ordered(void* buf, int count,
 30 const MPI::Datatype& datatype, MPI::Status& status) (*binding*
 31 *deprecated, see Section 15.2*) }

32
 33 {void MPI::File::Read_ordered(void* buf, int count,
 34 const MPI::Datatype& datatype) (*binding deprecated, see Section 15.2*)
 35 }

36
 37 MPI_FILE_READ_ORDERED is a collective version of the MPI_FILE_READ_SHARED
 38 interface.

39
 40 MPI_FILE_WRITE_ORDERED(fh, buf, count, datatype, status)

41
 42 INOUT fh file handle (handle)
 43 IN buf initial address of buffer (choice)
 44 IN count number of elements in buffer (integer)
 45 IN datatype datatype of each buffer element (handle)
 46
 47 OUT status status object (Status)

```

int MPI_File_write_ordered(MPI_File fh, const void *buf, int count,
    MPI_Datatype datatype, MPI_Status *status)
MPI_File_write_ordered(fh, buf, count, datatype, status, ierror) BIND(C)
    TYPE(MPI_File), INTENT(IN) :: fh
    TYPE(*), DIMENSION(..), INTENT(IN) :: buf
    INTEGER, INTENT(IN) :: count
    TYPE(MPI_Datatype), INTENT(IN) :: datatype
    TYPE(MPI_Status) :: status
    INTEGER, OPTIONAL, INTENT(OUT) :: ierror

MPI_FILE_WRITE_ORDERED(FH, BUF, COUNT, DATATYPE, STATUS, IERROR)
    <type> BUF(*)
    INTEGER FH, COUNT, DATATYPE, STATUS(MPI_STATUS_SIZE), IERROR

{void MPI::File::Write_ordered(const void* buf, int count,
    const MPI::Datatype& datatype, MPI::Status& status) (binding
    deprecated, see Section 15.2) }

{void MPI::File::Write_ordered(const void* buf, int count,
    const MPI::Datatype& datatype) (binding deprecated, see Section 15.2)
    }

```

MPI_FILE_WRITE_ORDERED is a collective version of the MPI_FILE_WRITE_SHARED interface.

Seek

If MPI_MODE_SEQUENTIAL mode was specified when the file was opened, it is erroneous to call the following two routines (MPI_FILE_SEEK_SHARED and MPI_FILE_GET_POSITION_SHARED).

```
MPI_FILE_SEEK_SHARED(fh, offset, whence)
```

INOUT	fh	file handle (handle)
IN	offset	file offset (integer)
IN	whence	update mode (state)

```
int MPI_File_seek_shared(MPI_File fh, MPI_Offset offset, int whence)
```

```

MPI_File_seek_shared(fh, offset, whence, ierror) BIND(C)
    TYPE(MPI_File), INTENT(IN) :: fh
    INTEGER(KIND=MPI_OFFSET_KIND), INTENT(IN) :: offset
    INTEGER, INTENT(IN) :: whence
    INTEGER, OPTIONAL, INTENT(OUT) :: ierror

```

```

MPI_FILE_SEEK_SHARED(FH, OFFSET, WHENCE, IERROR)
    INTEGER FH, WHENCE, IERROR
    INTEGER(KIND=MPI_OFFSET_KIND) OFFSET

```

```
1 {void MPI::File::Seek_shared(MPI::Offset offset, int whence) (binding
2     deprecated, see Section 15.2) }
```

3 MPI_FILE_SEEK_SHARED updates the shared file pointer according to whence, which
4 has the following possible values:

- 6 • MPI_SEEK_SET: the pointer is set to offset
- 7
- 8 • MPI_SEEK_CUR: the pointer is set to the current pointer position plus offset
- 9
- 10 • MPI_SEEK_END: the pointer is set to the end of file plus offset

11 MPI_FILE_SEEK_SHARED is collective; all the processes in the communicator group
12 associated with the file handle fh must call MPI_FILE_SEEK_SHARED with the same values
13 for offset and whence.

14 The offset can be negative, which allows seeking backwards. It is erroneous to seek to
15 a negative position in the view.

```
17
18 MPI_FILE_GET_POSITION_SHARED(fh, offset)
```

19	IN	fh	file handle (handle)
20			
21	OUT	offset	offset of shared pointer (integer)

```
22
23 int MPI_File_get_position_shared(MPI_File fh, MPI_Offset *offset)
```

```
24 MPI_File_get_position_shared(fh, offset, ierror) BIND(C)
25     TYPE(MPI_File), INTENT(IN) :: fh
26     INTEGER(KIND=MPI_OFFSET_KIND), INTENT(OUT) :: offset
27     INTEGER, OPTIONAL, INTENT(OUT) :: ierror
28
```

```
29 MPI_FILE_GET_POSITION_SHARED(FH, OFFSET, IERROR)
```

```
30     INTEGER FH, IERROR
31     INTEGER(KIND=MPI_OFFSET_KIND) OFFSET
```

```
32 {MPI::Offset MPI::File::Get_position_shared() const (binding deprecated, see
33     Section 15.2) }
```

34

35 MPI_FILE_GET_POSITION_SHARED returns, in offset, the current position of the
36 shared file pointer in etype units relative to the current view.

37

38 *Advice to users.* The offset can be used in a future call to MPI_FILE_SEEK_SHARED
39 using whence = MPI_SEEK_SET to return to the current position. To set the displace-
40 ment to the current file pointer position, first convert offset into an absolute byte
41 position using MPI_FILE_GET_BYTE_OFFSET, then call MPI_FILE_SET_VIEW with
42 the resulting displacement. (*End of advice to users.*)

43

44 13.4.5 Split Collective Data Access Routines

45 MPI provides a restricted form of “nonblocking collective” I/O operations for all data ac-
46 cesses using split collective data access routines. These routines are referred to as “split”
47 collective routines because a single collective operation is split in two: a begin routine and
48

an end routine. The begin routine begins the operation, much like a nonblocking data access (e.g., `MPI_FILE_IREAD`). The end routine completes the operation, much like the matching test or wait (e.g., `MPI_WAIT`). As with nonblocking data access operations, the user must not use the buffer passed to a begin routine while the routine is outstanding; the operation must be completed with an end routine before it is safe to free buffers, etc.

Split collective data access operations on a file handle `fh` are subject to the semantic rules given below.

- On any MPI process, each file handle may have at most one active split collective operation at any time.
- Begin calls are collective over the group of processes that participated in the collective open and follow the ordering rules for collective calls.
- End calls are collective over the group of processes that participated in the collective open and follow the ordering rules for collective calls. Each end call matches the preceding begin call for the same collective operation. When an “end” call is made, exactly one unmatched “begin” call for the same operation must precede it.
- An implementation is free to implement any split collective data access routine using the corresponding blocking collective routine when either the begin call (e.g., `MPI_FILE_READ_ALL_BEGIN`) or the end call (e.g., `MPI_FILE_READ_ALL_END`) is issued. The begin and end calls are provided to allow the user and MPI implementation to optimize the collective operation.
- Split collective operations do not match the corresponding regular collective operation. For example, in a single collective read operation, an `MPI_FILE_READ_ALL` on one process does not match an `MPI_FILE_READ_ALL_BEGIN/`
`MPI_FILE_READ_ALL_END` pair on another process.
- Split collective routines must specify a buffer in both the begin and end routines. By specifying the buffer that receives data in the end routine, we can avoid [many (though not all) of] the problems described in “A Problem with Code Movements and Register Optimization,” [Section 16.2.16, page 681.]Section 16.2.17 on page 682, but not all of the problems described in Section 16.2.16 on page 681.
- No collective I/O operations are permitted on a file handle concurrently with a split collective access on that file handle (i.e., between the begin and end of the access). That is

```
MPI_File_read_all_begin(fh, ...);
...
MPI_File_read_all(fh, ...);
...
MPI_File_read_all_end(fh, ...);
```

is erroneous.

- In a multithreaded implementation, any split collective begin and end operation called by a process must be called from the same thread. This restriction is made to simplify

1
2
3
4
5
6
7
8
9
10
11
12
13
14
15
16
17
18
19
20
21
22
23
24
25
26
27
28
29
30 ticket238-J.
31 ticket238-J.
32 ticket238-J.
33
34
35
36
37
38
39
40
41
42
43
44
45
46
47
48

1 the implementation in the multithreaded case. (Note that we have already disallowed
 2 having two threads begin a split collective operation on the same file handle since only
 3 one split collective operation can be active on a file handle at any time.)
 4

5 The arguments for these routines have the same meaning as for the equivalent collective
 6 versions (e.g., the argument definitions for `MPI_FILE_READ_ALL_BEGIN` and
 7 `MPI_FILE_READ_ALL_END` are equivalent to the arguments for `MPI_FILE_READ_ALL`).
 8 The begin routine (e.g., `MPI_FILE_READ_ALL_BEGIN`) begins a split collective operation
 9 that, when completed with the matching end routine (i.e., `MPI_FILE_READ_ALL_END`)
 10 produces the result as defined for the equivalent collective routine (i.e.,
 11 `MPI_FILE_READ_ALL`).

12 For the purpose of consistency semantics (Section 13.6.1, page 569), a matched pair
 13 of split collective data access operations (e.g., `MPI_FILE_READ_ALL_BEGIN` and
 14 `MPI_FILE_READ_ALL_END`) compose a single data access.

15
 16 `MPI_FILE_READ_AT_ALL_BEGIN(fh, offset, buf, count, datatype)`
 17

18	IN	fh	file handle (handle)
19	IN	offset	file offset (integer)
20	OUT	buf	initial address of buffer (choice)
21	IN	count	number of elements in buffer (integer)
22	IN	datatype	datatype of each buffer element (handle)

23
 24
 25
 26 `int MPI_File_read_at_all_begin(MPI_File fh, MPI_Offset offset, void *buf,`
 27 `int count, MPI_Datatype datatype)`

28 `MPI_File_read_at_all_begin(fh, offset, buf, count, datatype, ierror)`

29 `BIND(C)`

30 `TYPE(MPI_File), INTENT(IN) :: fh`
 31 `INTEGER(KIND=MPI_OFFSET_KIND), INTENT(IN) :: offset`
 32 `TYPE(*), DIMENSION(..), ASYNCHRONOUS :: buf`
 33 `INTEGER, INTENT(IN) :: count`
 34 `TYPE(MPI_Datatype), INTENT(IN) :: datatype`
 35 `INTEGER, OPTIONAL, INTENT(OUT) :: ierror`

36
 37 `MPI_FILE_READ_AT_ALL_BEGIN(FH, OFFSET, BUF, COUNT, DATATYPE, IERROR)`

38 `<type> BUF(*)`
 39 `INTEGER FH, COUNT, DATATYPE, IERROR`
 40 `INTEGER(KIND=MPI_OFFSET_KIND) OFFSET`

41 `{void MPI::File::Read_at_all_begin(MPI::Offset offset, void* buf,`
 42 `int count, const MPI::Datatype& datatype) (binding deprecated, see`
 43 `Section 15.2) }`
 44
 45
 46
 47
 48

```

MPI_FILE_READ_AT_ALL_END(fh, buf, status) 1
    IN      fh                file handle (handle) 2
    OUT     buf                initial address of buffer (choice) 3
    OUT     status            status object (Status) 4
                                         5
                                         6
int MPI_File_read_at_all_end(MPI_File fh, void *buf, MPI_Status *status) 7
MPI_File_read_at_all_end(fh, buf, status, ierror) BIND(C) 8 ticket-248T.
    TYPE(MPI_File), INTENT(IN) :: fh 9
    TYPE(*), DIMENSION(..), ASYNCHRONOUS :: buf 10
    TYPE(MPI_Status) :: status 11
    INTEGER, OPTIONAL, INTENT(OUT) :: ierror 12
MPI_FILE_READ_AT_ALL_END(FH, BUF, STATUS, IERROR) 13
    <type> BUF(*) 14
    INTEGER FH, STATUS(MPI_STATUS_SIZE), IERROR 15
{void MPI::File::Read_at_all_end(void* buf, MPI::Status& status) (binding 16
    deprecated, see Section 15.2) } 17
{void MPI::File::Read_at_all_end(void* buf) (binding deprecated, see Section 15.2) 18
    } 19
                                         20
                                         21
                                         22
                                         23
MPI_FILE_WRITE_AT_ALL_BEGIN(fh, offset, buf, count, datatype) 24
    INOUT   fh                file handle (handle) 25
    IN      offset            file offset (integer) 26
    IN      buf                initial address of buffer (choice) 27
    IN      count             number of elements in buffer (integer) 28
    IN      datatype          datatype of each buffer element (handle) 29
                                         30
                                         31
                                         32
int MPI_File_write_at_all_begin(MPI_File fh, MPI_Offset offset, const 33
    void *buf, int count, MPI_Datatype datatype) 34 ticket140.
MPI_File_write_at_all_begin(fh, offset, buf, count, datatype, ierror) 35
    BIND(C) 36 ticket-248T.
    TYPE(MPI_File), INTENT(IN) :: fh 37
    INTEGER(KIND=MPI_OFFSET_KIND), INTENT(IN) :: offset 38
    TYPE(*), DIMENSION(..), INTENT(IN), ASYNCHRONOUS :: buf 39
    INTEGER, INTENT(IN) :: count 40
    TYPE(MPI_Datatype), INTENT(IN) :: datatype 41
    INTEGER, OPTIONAL, INTENT(OUT) :: ierror 42
MPI_FILE_WRITE_AT_ALL_BEGIN(FH, OFFSET, BUF, COUNT, DATATYPE, IERROR) 43
    <type> BUF(*) 44
    INTEGER FH, COUNT, DATATYPE, IERROR 45
    INTEGER(KIND=MPI_OFFSET_KIND) OFFSET 46
                                         47
                                         48

```

```

1  {void MPI::File::Write_at_all_begin(MPI::Offset offset, const void* buf,
2      int count, const MPI::Datatype& datatype) (binding deprecated, see
3      Section 15.2) }
4
5
6

```

```

6  MPI_FILE_WRITE_AT_ALL_END(fh, buf, status)
7
8

```

```

8      INOUT   fh                file handle (handle)
9      IN      buf              initial address of buffer (choice)
10     OUT     status           status object (Status)
11

```

```

12  int MPI_File_write_at_all_end(MPI_File fh, const void *buf,
13      MPI_Status *status)
14

```

```

15  MPI_File_write_at_all_end(fh, buf, status, ierror) BIND(C)
16      TYPE(MPI_File), INTENT(IN) :: fh
17      TYPE(*), DIMENSION(..), INTENT(IN), ASYNCHRONOUS :: buf
18      TYPE(MPI_Status) :: status
19      INTEGER, OPTIONAL, INTENT(OUT) :: ierror
20

```

```

21  MPI_FILE_WRITE_AT_ALL_END(FH, BUF, STATUS, IERROR)
22      <type> BUF(*)
23      INTEGER FH, STATUS(MPI_STATUS_SIZE), IERROR
24

```

```

24  {void MPI::File::Write_at_all_end(const void* buf,
25      MPI::Status& status) (binding deprecated, see Section 15.2) }
26

```

```

27  {void MPI::File::Write_at_all_end(const void* buf) (binding deprecated, see
28      Section 15.2) }
29

```

```

30
31  MPI_FILE_READ_ALL_BEGIN(fh, buf, count, datatype)
32

```

```

32      INOUT   fh                file handle (handle)
33      OUT     buf              initial address of buffer (choice)
34      IN      count           number of elements in buffer (integer)
35      IN      datatype         datatype of each buffer element (handle)
36
37

```

```

38  int MPI_File_read_all_begin(MPI_File fh, void *buf, int count,
39      MPI_Datatype datatype)
40

```

```

41  MPI_File_read_all_begin(fh, buf, count, datatype, ierror) BIND(C)
42      TYPE(MPI_File), INTENT(IN) :: fh
43      TYPE(*), DIMENSION(..), ASYNCHRONOUS :: buf
44      INTEGER, INTENT(IN) :: count
45      TYPE(MPI_Datatype), INTENT(IN) :: datatype
46      INTEGER, OPTIONAL, INTENT(OUT) :: ierror
47

```

```

47  MPI_FILE_READ_ALL_BEGIN(FH, BUF, COUNT, DATATYPE, IERROR)
48

```

```

    <type> BUF(*)
    INTEGER FH, COUNT, DATATYPE, IERROR
{void MPI::File::Read_all_begin(void* buf, int count,
    const MPI::Datatype& datatype) (binding deprecated, see Section 15.2)
    }
}

MPI_FILE_READ_ALL_END(fh, buf, status)

    INOUT   fh                file handle (handle)
    OUT     buf                initial address of buffer (choice)
    OUT     status             status object (Status)

int MPI_File_read_all_end(MPI_File fh, void *buf, MPI_Status *status)

MPI_File_read_all_end(fh, buf, status, ierror) BIND(C)
    TYPE(MPI_File), INTENT(IN) :: fh
    TYPE(*), DIMENSION(..), ASYNCHRONOUS :: buf
    TYPE(MPI_Status) :: status
    INTEGER, OPTIONAL, INTENT(OUT) :: ierror

MPI_FILE_READ_ALL_END(FH, BUF, STATUS, IERROR)
    <type> BUF(*)
    INTEGER FH, STATUS(MPI_STATUS_SIZE), IERROR

{void MPI::File::Read_all_end(void* buf, MPI::Status& status) (binding
    deprecated, see Section 15.2) }

{void MPI::File::Read_all_end(void* buf) (binding deprecated, see Section 15.2) }

MPI_FILE_WRITE_ALL_BEGIN(fh, buf, count, datatype)

    INOUT   fh                file handle (handle)
    IN      buf                initial address of buffer (choice)
    IN      count              number of elements in buffer (integer)
    IN      datatype           datatype of each buffer element (handle)

int MPI_File_write_all_begin(MPI_File fh, const void *buf, int count,
    MPI_Datatype datatype)

MPI_File_write_all_begin(fh, buf, count, datatype, ierror) BIND(C)
    TYPE(MPI_File), INTENT(IN) :: fh
    TYPE(*), DIMENSION(..), INTENT(IN), ASYNCHRONOUS :: buf
    INTEGER, INTENT(IN) :: count
    TYPE(MPI_Datatype), INTENT(IN) :: datatype
    INTEGER, OPTIONAL, INTENT(OUT) :: ierror

MPI_FILE_WRITE_ALL_BEGIN(FH, BUF, COUNT, DATATYPE, IERROR)

```

```

1     <type> BUF(*)
2     INTEGER FH, COUNT, DATATYPE, IERROR
3
4     {void MPI::File::Write_all_begin(const void* buf, int count,
5         const MPI::Datatype& datatype) (binding deprecated, see Section 15.2)
6         }

```

```

7
8
9     MPI_FILE_WRITE_ALL_END(fh, buf, status)

```

```

10    INOUT   fh                file handle (handle)
11    IN      buf                initial address of buffer (choice)
12
13    OUT     status            status object (Status)

```

```

14
15    int MPI_File_write_all_end(MPI_File fh, const void *buf,
16        MPI_Status *status)

```

```

17
18    MPI_File_write_all_end(fh, buf, status, ierror) BIND(C)
19        TYPE(MPI_File), INTENT(IN) :: fh
20        TYPE(*), DIMENSION(..), INTENT(IN), ASYNCHRONOUS :: buf
21        TYPE(MPI_Status) :: status
22        INTEGER, OPTIONAL, INTENT(OUT) :: ierror

```

```

23    MPI_FILE_WRITE_ALL_END(FH, BUF, STATUS, IERROR)

```

```

24    <type> BUF(*)
25    INTEGER FH, STATUS(MPI_STATUS_SIZE), IERROR
26
27    {void MPI::File::Write_all_end(const void* buf, MPI::Status& status) (binding
28        deprecated, see Section 15.2) }

```

```

29    {void MPI::File::Write_all_end(const void* buf) (binding deprecated, see
30        Section 15.2) }

```

```

31
32
33    MPI_FILE_READ_ORDERED_BEGIN(fh, buf, count, datatype)

```

```

34    INOUT   fh                file handle (handle)
35
36    OUT     buf                initial address of buffer (choice)
37
38    IN      count              number of elements in buffer (integer)
39
40    IN      datatype           datatype of each buffer element (handle)

```

```

41    int MPI_File_read_ordered_begin(MPI_File fh, void *buf, int count,
42        MPI_Datatype datatype)

```

```

43
44    MPI_File_read_ordered_begin(fh, buf, count, datatype, ierror) BIND(C)
45        TYPE(MPI_File), INTENT(IN) :: fh
46        TYPE(*), DIMENSION(..), ASYNCHRONOUS :: buf
47        INTEGER, INTENT(IN) :: count
48        TYPE(MPI_Datatype), INTENT(IN) :: datatype

```

```

    INTEGER, OPTIONAL, INTENT(OUT) :: ierror
1
MPI_FILE_READ_ORDERED_BEGIN(FH, BUF, COUNT, DATATYPE, IERROR)
2
    <type> BUF(*)
3
    INTEGER FH, COUNT, DATATYPE, IERROR
4
5
{void MPI::File::Read_ordered_begin(void* buf, int count,
6
    const MPI::Datatype& datatype) (binding deprecated, see Section 15.2)
7
    }
8
9
10
MPI_FILE_READ_ORDERED_END(fh, buf, status)
11
    INOUT   fh                file handle (handle)
12
    OUT     buf                initial address of buffer (choice)
13
    OUT     status             status object (Status)
14
15
16
int MPI_File_read_ordered_end(MPI_File fh, void *buf, MPI_Status *status)
17
18
MPI_File_read_ordered_end(fh, buf, status, ierror) BIND(C)
19
    TYPE(MPI_File), INTENT(IN) :: fh
20
    TYPE(*), DIMENSION(..), ASYNCHRONOUS :: buf
21
    TYPE(MPI_Status) :: status
22
    INTEGER, OPTIONAL, INTENT(OUT) :: ierror
23
24
MPI_FILE_READ_ORDERED_END(FH, BUF, STATUS, IERROR)
25
    <type> BUF(*)
26
    INTEGER FH, STATUS(MPI_STATUS_SIZE), IERROR
27
28
{void MPI::File::Read_ordered_end(void* buf, MPI::Status& status) (binding
29
    deprecated, see Section 15.2) }
30
31
{void MPI::File::Read_ordered_end(void* buf) (binding deprecated, see Section 15.2)
32
    }
33
34
MPI_FILE_WRITE_ORDERED_BEGIN(fh, buf, count, datatype)
35
    INOUT   fh                file handle (handle)
36
    IN      buf                initial address of buffer (choice)
37
    IN      count              number of elements in buffer (integer)
38
    IN      datatype           datatype of each buffer element (handle)
39
40
41
int MPI_File_write_ordered_begin(MPI_File fh, const void *buf, int count,
42
    MPI_Datatype datatype)
43
44
MPI_File_write_ordered_begin(fh, buf, count, datatype, ierror) BIND(C)
45
    TYPE(MPI_File), INTENT(IN) :: fh
46
    TYPE(*), DIMENSION(..), INTENT(IN), ASYNCHRONOUS :: buf
47
    INTEGER, INTENT(IN) :: count
48

```

ticket-248T.

ticket140.

ticket-248T.

```

1     TYPE(MPI_Datatype), INTENT(IN) :: datatype
2     INTEGER, OPTIONAL, INTENT(OUT) :: ierror
3
4 MPI_FILE_WRITE_ORDERED_BEGIN(FH, BUF, COUNT, DATATYPE, IERROR)
5     <type> BUF(*)
6     INTEGER FH, COUNT, DATATYPE, IERROR
7
8 {void MPI::File::Write_ordered_begin(const void* buf, int count,
9     const MPI::Datatype& datatype) (binding deprecated, see Section 15.2)
10     }
11
12 MPI_FILE_WRITE_ORDERED_END(fh, buf, status)
13
14     INOUT    fh                file handle (handle)
15     IN      buf                initial address of buffer (choice)
16     OUT     status             status object (Status)
17
18 int MPI_File_write_ordered_end(MPI_File fh, const void *buf,
19     MPI_Status *status)
20
21 MPI_File_write_ordered_end(fh, buf, status, ierror) BIND(C)
22     TYPE(MPI_File), INTENT(IN) :: fh
23     TYPE(*), DIMENSION(..), INTENT(IN), ASYNCHRONOUS :: buf
24     TYPE(MPI_Status) :: status
25     INTEGER, OPTIONAL, INTENT(OUT) :: ierror
26
27 MPI_FILE_WRITE_ORDERED_END(FH, BUF, STATUS, IERROR)
28     <type> BUF(*)
29     INTEGER FH, STATUS(MPI_STATUS_SIZE), IERROR
30
31 {void MPI::File::Write_ordered_end(const void* buf,
32     MPI::Status& status) (binding deprecated, see Section 15.2) }
33
34 {void MPI::File::Write_ordered_end(const void* buf) (binding deprecated, see
35     Section 15.2) }
36
37
38
39
40
41
42
43
44
45
46
47
48

```

13.5 File Interoperability

At the most basic level, file interoperability is the ability to read the information previously written to a file—not just the bits of data, but the actual information the bits represent. MPI guarantees full interoperability within a single MPI environment, and supports increased interoperability outside that environment through the external data representation (Section 13.5.2, page 562) as well as the data conversion functions (Section 13.5.3, page 563).

Interoperability within a single MPI environment (which could be considered “operability”) ensures that file data written by one MPI process can be read by any other MPI process, subject to the consistency constraints (see Section 13.6.1, page 569), provided that it would have been possible to start the two processes simultaneously and have them reside

in a single MPI_COMM_WORLD. Furthermore, both processes must see the same data values at every absolute byte offset in the file for which data was written.

This single environment file interoperability implies that file data is accessible regardless of the number of processes.

There are three aspects to file interoperability:

- transferring the bits,
- converting between different file structures, and
- converting between different machine representations.

The first two aspects of file interoperability are beyond the scope of this standard, as both are highly machine dependent. However, transferring the bits of a file into and out of the MPI environment (e.g., by writing a file to tape) is required to be supported by all MPI implementations. In particular, an implementation must specify how familiar operations similar to POSIX `cp`, `rm`, and `mv` can be performed on the file. Furthermore, it is expected that the facility provided maintains the correspondence between absolute byte offsets (e.g., after possible file structure conversion, the data bits at byte offset 102 in the MPI environment are at byte offset 102 outside the MPI environment). As an example, a simple off-line conversion utility that transfers and converts files between the native file system and the MPI environment would suffice, provided it maintained the offset coherence mentioned above. In a high-quality implementation of MPI, users will be able to manipulate MPI files using the same or similar tools that the native file system offers for manipulating its files.

The remaining aspect of file interoperability, converting between different machine representations, is supported by the typing information specified in the `etype` and `filetype`. This facility allows the information in files to be shared between any two applications, regardless of whether they use MPI, and regardless of the machine architectures on which they run.

MPI supports multiple data representations: “native,” “internal,” and “external32.” An implementation may support additional data representations. MPI also supports user-defined data representations (see Section 13.5.3, page 563). The “native” and “internal” data representations are implementation dependent, while the “external32” representation is common to all MPI implementations and facilitates file interoperability. The data representation is specified in the `datarep` argument to `MPI_FILE_SET_VIEW`.

Advice to users. MPI is not guaranteed to retain knowledge of what data representation was used when a file is written. Therefore, to correctly retrieve file data, an MPI application is responsible for specifying the same data representation as was used to create the file. (*End of advice to users.*)

“native” Data in this representation is stored in a file exactly as it is in memory. The advantage of this data representation is that data precision and I/O performance are not lost in type conversions with a purely homogeneous environment. The disadvantage is the loss of transparent interoperability within a heterogeneous MPI environment.

Advice to users. This data representation should only be used in a homogeneous MPI environment, or when the MPI application is capable of performing the data type conversions itself. (*End of advice to users.*)

1 *Advice to implementors.* When implementing read and write operations on
 2 top of MPI message-passing, the message data should be typed as `MPI_BYTE`
 3 to ensure that the message routines do not perform any type conversions on the
 4 data. (*End of advice to implementors.*)

5
 6 **“internal”** This data representation can be used for I/O operations in a homogeneous
 7 or heterogeneous environment; the implementation will perform type conversions if
 8 necessary. The implementation is free to store data in any format of its choice, with
 9 the restriction that it will maintain constant extents for all predefined datatypes in any
 10 one file. The environment in which the resulting file can be reused is implementation-
 11 defined and must be documented by the implementation.

12
 13 *Rationale.* This data representation allows the implementation to perform I/O
 14 efficiently in a heterogeneous environment, though with implementation-defined
 15 restrictions on how the file can be reused. (*End of rationale.*)

16
 17 *Advice to implementors.* Since “external32” is a superset of the functionality
 18 provided by “internal,” an implementation may choose to implement “internal”
 19 as “external32.” (*End of advice to implementors.*)

20
 21 **“external32”** This data representation states that read and write operations convert all
 22 data from and to the “external32” representation defined in Section 13.5.2, page 562.
 23 The data conversion rules for communication also apply to these conversions (see
 24 Section 3.3.2, page 25-27, of the MPI-1 document). The data on the storage medium
 25 is always in this canonical representation, and the data in memory is always in the
 26 local process’s native representation.

27 This data representation has several advantages. First, all processes reading the file
 28 in a heterogeneous MPI environment will automatically have the data converted to
 29 their respective native representations. Second, the file can be exported from one MPI
 30 environment and imported into any other MPI environment with the guarantee that
 31 the second environment will be able to read all the data in the file.

32 The disadvantage of this data representation is that data precision and I/O perfor-
 33 mance may be lost in data type conversions.

34
 35 *Advice to implementors.* When implementing read and write operations on top
 36 of MPI message-passing, the message data should be converted to and from the
 37 “external32” representation in the client, and sent as type `MPI_BYTE`. This will
 38 avoid possible double data type conversions and the associated further loss of
 39 precision and performance. (*End of advice to implementors.*)

40 41 13.5.1 Datatypes for File Interoperability

42
 43 If the file data representation is other than “native,” care must be taken in constructing
 44 etypes and filetypes. Any of the datatype constructor functions may be used; however,
 45 for those functions that accept displacements in bytes, the displacements must be specified
 46 in terms of their values in the file for the file data representation being used. MPI will
 47 interpret these byte displacements as is; no scaling will be done. The function
 48 `MPI_FILE_GET_TYPE_EXTENT` can be used to calculate the extents of datatypes in the

file. For etypes and filetypes that are portable datatypes (see Section 2.4, page 11), MPI will scale any displacements in the datatypes to match the file data representation. Datatypes passed as arguments to read/write routines specify the data layout in memory; therefore, they must always be constructed using displacements corresponding to displacements in memory.

Advice to users. One can logically think of the file as if it were stored in the memory of a file server. The `etype` and `filetype` are interpreted as if they were defined at this file server, by the same sequence of calls used to define them at the calling process. If the data representation is “native”, then this logical file server runs on the same architecture as the calling process, so that these types define the same data layout on the file as they would define in the memory of the calling process. If the `etype` and `filetype` are portable datatypes, then the data layout defined in the file is the same as would be defined in the calling process memory, up to a scaling factor. The routine `MPI_FILE_GET_FILE_EXTENT` can be used to calculate this scaling factor. Thus, two equivalent, portable datatypes will define the same data layout in the file, even in a heterogeneous environment with “internal”, “external32”, or user defined data representations. Otherwise, the `etype` and `filetype` must be constructed so that their typemap and extent are the same on any architecture. This can be achieved if they have an explicit upper bound and lower bound (defined either using `MPI_LB` and `MPI_UB` markers, or using `MPI_TYPE_CREATE_RESIZED`). This condition must also be fulfilled by any datatype that is used in the construction of the `etype` and `filetype`, if this datatype is replicated contiguously, either explicitly, by a call to `MPI_TYPE_CONTIGUOUS`, or implicitly, by a blocklength argument that is greater than one. If an `etype` or `filetype` is not portable, and has a typemap or extent that is architecture dependent, then the data layout specified by it on a file is implementation dependent.

File data representations other than “native” may be different from corresponding data representations in memory. Therefore, for these file data representations, it is important not to use hardwired byte offsets for file positioning, including the initial displacement that specifies the view. When a portable datatype (see Section 2.4, page 11) is used in a data access operation, any holes in the datatype are scaled to match the data representation. However, note that this technique only works when all the processes that created the file view build their etypes from the same predefined datatypes. For example, if one process uses an `etype` built from `MPI_INT` and another uses an `etype` built from `MPI_FLOAT`, the resulting views may be nonportable because the relative sizes of these types may differ from one data representation to another. (*End of advice to users.*)

`MPI_FILE_GET_TYPE_EXTENT(fh, datatype, extent)`

IN	<code>fh</code>	file handle (handle)
IN	<code>datatype</code>	datatype (handle)
OUT	<code>extent</code>	datatype extent (integer)

```

1 int MPI_File_get_type_extent(MPI_File fh, MPI_Datatype datatype,
2     MPI_Aint *extent)
3
4 MPI_File_get_type_extent(fh, datatype, extent, ierror) BIND(C)
5     TYPE(MPI_File), INTENT(IN) :: fh
6     TYPE(MPI_Datatype), INTENT(IN) :: datatype
7     INTEGER(KIND=MPI_ADDRESS_KIND), INTENT(OUT) :: extent
8     INTEGER, OPTIONAL, INTENT(OUT) :: ierror
9
10 MPI_FILE_GET_TYPE_EXTENT(FH, DATATYPE, EXTENT, IERROR)
11     INTEGER FH, DATATYPE, IERROR
12     INTEGER(KIND=MPI_ADDRESS_KIND) EXTENT
13
14 {MPI::Aint MPI::File::Get_type_extent(const MPI::Datatype& datatype)
15     const(binding deprecated, see Section 15.2) }

```

Returns the extent of `datatype` in the file `fh`. This extent will be the same for all processes accessing the file `fh`. If the current view uses a user-defined data representation (see Section 13.5.3, page 563), MPI uses the `dtype_file_extent_fn` callback to calculate the extent.

Advice to implementors. In the case of user-defined data representations, the extent of a derived datatype can be calculated by first determining the extents of the predefined datatypes in this derived datatype using `dtype_file_extent_fn` (see Section 13.5.3, page 563). (*End of advice to implementors.*)

13.5.2 External Data Representation: “external32”

All MPI implementations are required to support the data representation defined in this section. Support of optional datatypes (e.g., `MPI_INTEGER2`) is not required.

All floating point values are in big-endian IEEE format [36] of the appropriate size. Floating point values are represented by one of three IEEE formats. These are the IEEE “Single,” “Double,” and “Double Extended” formats, requiring 4, 8 and 16 bytes of storage, respectively. For the IEEE “Double Extended” formats, MPI specifies a Format Width of 16 bytes, with 15 exponent bits, bias = +16383, 112 fraction bits, and an encoding analogous to the “Double” format. All integral values are in two’s complement big-endian format. Big-endian means most significant byte at lowest address byte. For C `_Bool`, Fortran `LOGICAL` and C++ `bool`, 0 implies false and nonzero implies true. C `float` `_Complex`, `double` `_Complex` and `long double` `_Complex` as well as Fortran `COMPLEX` and `DOUBLE COMPLEX` are represented by a pair of floating point format values for the real and imaginary components. Characters are in ISO 8859-1 format [37]. Wide characters (of type `MPI_WCHAR`) are in Unicode format [60].

All signed numerals (e.g., `MPI_INT`, `MPI_REAL`) have the sign bit at the most significant bit. `MPI_COMPLEX` and `MPI_DOUBLE_COMPLEX` have the sign bit of the real and imaginary parts at the most significant bit of each part.

According to IEEE specifications [36], the “NaN” (not a number) is system dependent. It should not be interpreted within MPI as anything other than “NaN.”

Advice to implementors. The MPI treatment of “NaN” is similar to the approach used in XDR (see <ftp://ds.internic.net/rfc/rfc1832.txt>). (*End of advice to implementors.*)

All data is byte aligned, regardless of type. All data items are stored contiguously in the file (if the file view is contiguous).

Advice to implementors. All bytes of `LOGICAL` and `bool` must be checked to determine the value. (*End of advice to implementors.*)

Advice to users. The type `MPI_PACKED` is treated as bytes and is not converted. The user should be aware that `MPI_PACK` has the option of placing a header in the beginning of the pack buffer. (*End of advice to users.*)

The size of the predefined datatypes returned from `MPI_TYPE_CREATE_F90_REAL`, `MPI_TYPE_CREATE_F90_COMPLEX`, and `MPI_TYPE_CREATE_F90_INTEGER` are defined in Section 16.2.9, page 668.

Advice to implementors. When converting a larger size integer to a smaller size integer, only the less significant bytes are moved. Care must be taken to preserve the sign bit value. This allows no conversion errors if the data range is within the range of the smaller size integer. (*End of advice to implementors.*)

Table 13.2 specifies the sizes of predefined datatypes in “external32” format.

13.5.3 User-Defined Data Representations

There are two situations that cannot be handled by the required representations:

1. a user wants to write a file in a representation unknown to the implementation, and
2. a user wants to read a file written in a representation unknown to the implementation.

User-defined data representations allow the user to insert a third party converter into the I/O stream to do the data representation conversion.

```
MPI_REGISTER_DATAREP(datarep, read_conversion_fn, write_conversion_fn,
                    dtype_file_extent_fn, extra_state)
```

IN	<code>datarep</code>	data representation identifier (string)
IN	<code>read_conversion_fn</code>	function invoked to convert from file representation to native representation (function)
IN	<code>write_conversion_fn</code>	function invoked to convert from native representation to file representation (function)
IN	<code>dtype_file_extent_fn</code>	function invoked to get the extent of a datatype as represented in the file (function)
IN	<code>extra_state</code>	extra state

```
int MPI_Register_datarep(const char *datarep,
                       MPI_Datarep_conversion_function *read_conversion_fn,
                       MPI_Datarep_conversion_function *write_conversion_fn,
                       MPI_Datarep_extent_function *dtype_file_extent_fn,
                       void *extra_state)
```

Type	Length	Optional Type	Length
MPI_PACKED	1	MPI_INTEGER1	1
MPI_BYTE	1	MPI_INTEGER2	2
MPI_CHAR	1	MPI_INTEGER4	4
MPI_UNSIGNED_CHAR	1	MPI_INTEGER8	8
MPI_SIGNED_CHAR	1	MPI_INTEGER16	16
MPI_WCHAR	2		
MPI_SHORT	2	MPI_REAL2	2
MPI_UNSIGNED_SHORT	2	MPI_REAL4	4
MPI_INT	4	MPI_REAL8	8
MPI_UNSIGNED	4	MPI_REAL16	16
MPI_LONG	4		
MPI_UNSIGNED_LONG	4	MPI_COMPLEX4	2*2
MPI_LONG_LONG_INT	8	MPI_COMPLEX8	2*4
MPI_UNSIGNED_LONG_LONG	8	MPI_COMPLEX16	2*8
MPI_FLOAT	4	MPI_COMPLEX32	2*16
MPI_DOUBLE	8		
MPI_LONG_DOUBLE	16		
MPI_C_BOOL	[ticket171.] [4] 1		
MPI_INT8_T	1		
MPI_INT16_T	2		
MPI_INT32_T	4		
MPI_INT64_T	8		
MPI_UINT8_T	1		
MPI_UINT16_T	2		
MPI_UINT32_T	4		
MPI_UINT64_T	8		
MPI_AINT	8		
MPI_OFFSET	8		
MPI_C_COMPLEX	2*4		
MPI_C_FLOAT_COMPLEX	2*4		
MPI_C_DOUBLE_COMPLEX	2*8		
MPI_C_LONG_DOUBLE_COMPLEX	2*16		
MPI_CHARACTER	1		
MPI_LOGICAL	4		
MPI_INTEGER	4		
MPI_REAL	4		
MPI_DOUBLE_PRECISION	8		
MPI_COMPLEX	2*4		
MPI_DOUBLE_COMPLEX	2*8		

Table 13.2: “external32” sizes of predefined datatypes

```

MPI_Register_datarep(datarep, read_conversion_fn, write_conversion_fn,
                    dtype_file_extent_fn, extra_state, ierror) BIND(C)
    CHARACTER(LEN=*), INTENT(IN) :: datarep
    PROCEDURE(MPI_Datarep_conversion_function) :: read_conversion_fn
    PROCEDURE(MPI_Datarep_conversion_function) :: write_conversion_fn
    PROCEDURE(MPI_Datarep_extent_function) :: dtype_file_extent_fn
    INTEGER(KIND=MPI_ADDRESS_KIND), INTENT(IN) :: extra_state
    INTEGER, OPTIONAL, INTENT(OUT) :: ierror

MPI_REGISTER_DATAREP(DATAREP, READ_CONVERSION_FN, WRITE_CONVERSION_FN,
                    DTYPE_FILE_EXTENT_FN, EXTRA_STATE, IERROR)
    CHARACTER*(*) DATAREP
    EXTERNAL READ_CONVERSION_FN, WRITE_CONVERSION_FN, DTYPE_FILE_EXTENT_FN
    INTEGER(KIND=MPI_ADDRESS_KIND) EXTRA_STATE
    INTEGER IERROR

{void MPI::Register_datarep(const char* datarep,
    MPI::Datarep_conversion_function* read_conversion_fn,
    MPI::Datarep_conversion_function* write_conversion_fn,
    MPI::Datarep_extent_function* dtype_file_extent_fn,
    void* extra_state) (binding deprecated, see Section 15.2) }

```

The call associates `read_conversion_fn`, `write_conversion_fn`, and `dtype_file_extent_fn` with the data representation identifier `datarep`. `datarep` can then be used as an argument to `MPI_FILE_SET_VIEW`, causing subsequent data access operations to call the conversion functions to convert all data items accessed between file data representation and native representation. `MPI_REGISTER_DATAREP` is a local operation and only registers the data representation for the calling MPI process. If `datarep` is already defined, an error in the error class `MPI_ERR_DUP_DATAREP` is raised using the default file error handler (see Section 13.7, page 578). The length of a data representation string is limited to the value of `MPI_MAX_DATAREP_STRING`. `MPI_MAX_DATAREP_STRING` must have a value of at least 64. No routines are provided to delete data representations and free the associated resources; it is not expected that an application will generate them in significant numbers.

Extent Callback

```

typedef int MPI_Datarep_extent_function(MPI_Datatype datatype,
    MPI_Aint *file_extent, void *extra_state);

ABSTRACT INTERFACE
    SUBROUTINE MPI_Datarep_extent_function(datatype, extent, extra_state,
    ierror) BIND(C)
        TYPE(MPI_Datatype) :: datatype
        INTEGER(KIND=MPI_ADDRESS_KIND) :: extent, extra_state
        INTEGER :: ierror

SUBROUTINE DATAREP_EXTENT_FUNCTION(DATATYPE, EXTENT, EXTRA_STATE, IERROR)
    INTEGER DATATYPE, IERROR
    INTEGER(KIND=MPI_ADDRESS_KIND) EXTENT, EXTRA_STATE

```

```

1 {typedef void MPI::Datarep_extent_function(const MPI::Datatype& datatype,
2     MPI::Aint& file_extent, void* extra_state); (binding deprecated,
3     see Section 15.2)}
4

```

The function `dtype_file_extent_fn` must return, in `file_extent`, the number of bytes required to store `datatype` in the file representation. The function is passed, in `extra_state`, the argument that was passed to the `MPI_REGISTER_DATAREP` call. MPI will only call this routine with predefined datatypes employed by the user.

Datarep Conversion Functions

```

11 typedef int MPI_Datarep_conversion_function(void *userbuf,
12     MPI_Datatype datatype, int count, void *filebuf,
13     MPI_Offset position, void *extra_state);
14

```

ABSTRACT INTERFACE

```

15 SUBROUTINE MPI_Datarep_conversion_function(userbuf, datatype, count,
16     filebuf, position, extra_state, ierror) BIND(C)
17     USE, INTRINSIC :: ISO_C_BINDING, ONLY : C_PTR
18     TYPE(C_PTR), VALUE :: userbuf, filebuf
19     TYPE(MPI_Datatype) :: datatype
20     INTEGER :: count, ierror
21     INTEGER(KIND=MPI_OFFSET_KIND) :: position
22     INTEGER(KIND=MPI_ADDRESS_KIND) :: extra_state
23

```

```

24 SUBROUTINE DATAREP_CONVERSION_FUNCTION(USERBUF, DATATYPE, COUNT, FILEBUF,
25     POSITION, EXTRA_STATE, IERROR)
26     <TYPE> USERBUF(*), FILEBUF(*)
27     INTEGER COUNT, DATATYPE, IERROR
28     INTEGER(KIND=MPI_OFFSET_KIND) POSITION
29     INTEGER(KIND=MPI_ADDRESS_KIND) EXTRA_STATE
30

```

```

31 {typedef void MPI::Datarep_conversion_function(void* userbuf,
32     MPI::Datatype& datatype, int count, void* filebuf,
33     MPI::Offset position, void* extra_state); (binding deprecated, see
34     Section 15.2)}
35

```

The function `read_conversion_fn` must convert from file data representation to native representation. Before calling this routine, MPI allocates and fills `filebuf` with `count` contiguous data items. The type of each data item matches the corresponding entry for the predefined datatype in the type signature of `datatype`. The function is passed, in `extra_state`, the argument that was passed to the `MPI_REGISTER_DATAREP` call. The function must copy all `count` data items from `filebuf` to `userbuf` in the distribution described by `datatype`, converting each data item from file representation to native representation. `datatype` will be equivalent to the datatype that the user passed to the read function. If the size of `datatype` is less than the size of the `count` data items, the conversion function must treat `datatype` as being contiguously tiled over the `userbuf`. The conversion function must begin storing converted data at the location in `userbuf` specified by `position` into the (tiled) `datatype`.

Advice to users. Although the conversion functions have similarities to `MPI_PACK`

and `MPI_UNPACK`, one should note the differences in the use of the arguments `count` and `position`. In the conversion functions, `count` is a count of data items (i.e., count of typemap entries of `datatype`), and `position` is an index into this typemap. In `MPI_PACK`, `incount` refers to the number of whole `datatypes`, and `position` is a number of bytes. (*End of advice to users.*)

Advice to implementors. A converted read operation could be implemented as follows:

1. Get file extent of all data items
2. Allocate a filebuf large enough to hold all count data items
3. Read data from file into filebuf
4. Call `read_conversion_fn` to convert data and place it into userbuf
5. Deallocate filebuf

(*End of advice to implementors.*)

If MPI cannot allocate a buffer large enough to hold all the data to be converted from a read operation, it may call the conversion function repeatedly using the same `datatype` and `userbuf`, and reading successive chunks of data to be converted in `filebuf`. For the first call (and in the case when all the data to be converted fits into `filebuf`), MPI will call the function with `position` set to zero. Data converted during this call will be stored in the `userbuf` according to the first `count` data items in `datatype`. Then in subsequent calls to the conversion function, MPI will increment the value in `position` by the `count` of items converted in the previous call, and the `userbuf` pointer will be unchanged.

Rationale. Passing the conversion function a `position` and one `datatype` for the transfer allows the conversion function to decode the `datatype` only once and cache an internal representation of it on the `datatype`. Then on subsequent calls, the conversion function can use the `position` to quickly find its place in the `datatype` and continue storing converted data where it left off at the end of the previous call. (*End of rationale.*)

Advice to users. Although the conversion function may usefully cache an internal representation on the `datatype`, it should not cache any state information specific to an ongoing conversion operation, since it is possible for the same `datatype` to be used concurrently in multiple conversion operations. (*End of advice to users.*)

The function `write_conversion_fn` must convert from native representation to file data representation. Before calling this routine, MPI allocates `filebuf` of a size large enough to hold `count` contiguous data items. The type of each data item matches the corresponding entry for the predefined `datatype` in the type signature of `datatype`. The function must copy `count` data items from `userbuf` in the distribution described by `datatype`, to a contiguous distribution in `filebuf`, converting each data item from native representation to file representation. If the size of `datatype` is less than the size of `count` data items, the conversion function must treat `datatype` as being contiguously tiled over the `userbuf`.

The function must begin copying at the location in `userbuf` specified by `position` into the (tiled) `datatype`. `datatype` will be equivalent to the `datatype` that the user passed to the

1 write function. The function is passed, in `extra_state`, the argument that was passed to the
2 `MPI_REGISTER_DATAREP` call.

3 The predefined constant `MPI_CONVERSION_FN_NULL` may be used as either
4 `write_conversion_fn` or `read_conversion_fn`. In that case, MPI will not attempt to invoke
5 `write_conversion_fn` or `read_conversion_fn`, respectively, but will perform the requested data
6 access using the native data representation.

7 An MPI implementation must ensure that all data accessed is converted, either by
8 using a filebuf large enough to hold all the requested data items or else by making repeated
9 calls to the conversion function with the same `datatype` argument and appropriate values
10 for `position`.

11 An implementation will only invoke the callback routines in this section
12 (`read_conversion_fn`, `write_conversion_fn`, and `dtype_file_extent_fn`) when one of the read or
13 write routines in Section 13.4, page 529, or `MPI_FILE_GET_TYPE_EXTENT` is called by
14 the user. `dtype_file_extent_fn` will only be passed predefined datatypes employed by the
15 user. The conversion functions will only be passed datatypes equivalent to those that the
16 user has passed to one of the routines noted above.

17 The conversion functions must be reentrant. User defined data representations are
18 restricted to use byte alignment for all types. Furthermore, it is erroneous for the conversion
19 functions to call any collective routines or to free `datatype`.

20 The conversion functions should return an error code. If the returned error code has
21 a value other than `MPI_SUCCESS`, the implementation will raise an error in the class
22 `MPI_ERR_CONVERSION`.

24 13.5.4 Matching Data Representations

25 It is the user's responsibility to ensure that the data representation used to read data from
26 a file is *compatible* with the data representation that was used to write that data to the file.

27 In general, using the same data representation name when writing and reading a file
28 does not guarantee that the representation is compatible. Similarly, using different repre-
29 sentation names on two different implementations may yield compatible representations.

30 Compatibility can be obtained when "external32" representation is used, although
31 precision may be lost and the performance may be less than when "native" representation is
32 used. Compatibility is guaranteed using "external32" provided at least one of the following
33 conditions is met.

- 34 • The data access routines directly use types enumerated in Section 13.5.2, page 562,
35 that are supported by all implementations participating in the I/O. The predefined
36 type used to write a data item must also be used to read a data item.
- 37 • In the case of Fortran 90 programs, the programs participating in the data accesses
38 obtain compatible datatypes using MPI routines that specify precision and/or range
39 (Section 16.2.9, page 664).
- 40 • For any given data item, the programs participating in the data accesses use compat-
41 ible predefined types to write and read the data item.

42 User-defined data representations may be used to provide an implementation compat-
43 ibility with another implementation's "native" or "internal" representation.

Advice to users. Section 16.2.9, page 664, defines routines that support the use of matching datatypes in heterogeneous environments and contains examples illustrating their use. (*End of advice to users.*)

13.6 Consistency and Semantics

13.6.1 File Consistency

Consistency semantics define the outcome of multiple accesses to a single file. All file accesses in MPI are relative to a specific file handle created from a collective open. MPI provides three levels of consistency: sequential consistency among all accesses using a single file handle, sequential consistency among all accesses using file handles created from a single collective open with atomic mode enabled, and user-imposed consistency among accesses other than the above. Sequential consistency means the behavior of a set of operations will be as if the operations were performed in some serial order consistent with program order; each access appears atomic, although the exact ordering of accesses is unspecified. User-imposed consistency may be obtained using program order and calls to `MPI_FILE_SYNC`.

Let FH_1 be the set of file handles created from one particular collective open of the file FOO , and FH_2 be the set of file handles created from a different collective open of FOO . Note that nothing restrictive is said about FH_1 and FH_2 : the sizes of FH_1 and FH_2 may be different, the groups of processes used for each open may or may not intersect, the file handles in FH_1 may be destroyed before those in FH_2 are created, etc. Consider the following three cases: a single file handle (e.g., $fh_1 \in FH_1$), two file handles created from a single collective open (e.g., $fh_{1a} \in FH_1$ and $fh_{1b} \in FH_1$), and two file handles from different collective opens (e.g., $fh_1 \in FH_1$ and $fh_2 \in FH_2$).

For the purpose of consistency semantics, a matched pair (Section 13.4.5, page 550) of split collective data access operations (e.g., `MPI_FILE_READ_ALL_BEGIN` and `MPI_FILE_READ_ALL_END`) compose a single data access operation. Similarly, a non-blocking data access routine (e.g., `MPI_FILE_IREAD`) and the routine which completes the request (e.g., `MPI_WAIT`) also compose a single data access operation. For all cases below, these data access operations are subject to the same constraints as blocking data access operations.

Advice to users. For an `MPI_FILE_IREAD` and `MPI_WAIT` pair, the operation begins when `MPI_FILE_IREAD` is called and ends when `MPI_WAIT` returns. (*End of advice to users.*)

Assume that A_1 and A_2 are two data access operations. Let D_1 (D_2) be the set of absolute byte displacements of every byte accessed in A_1 (A_2). The two data accesses *overlap* if $D_1 \cap D_2 \neq \emptyset$. The two data accesses *conflict* if they overlap and at least one is a write access.

Let SEQ_{fh} be a sequence of file operations on a single file handle, bracketed by `MPI_FILE_SYNC`s on that file handle. (Both opening and closing a file implicitly perform an `MPI_FILE_SYNC`.) SEQ_{fh} is a “write sequence” if any of the data access operations in the sequence are writes or if any of the file manipulation operations in the sequence change the state of the file (e.g., `MPI_FILE_SET_SIZE` or `MPI_FILE_PREALLOCATE`). Given two sequences, SEQ_1 and SEQ_2 , we say they are not *concurrent* if one sequence is guaranteed to completely precede the other (temporally).

The requirements for guaranteeing sequential consistency among all accesses to a particular file are divided into the three cases given below. If any of these requirements are not met, then the value of all data in that file is implementation dependent.

Case 1: $fh_1 \in FH_1$ All operations on fh_1 are sequentially consistent if atomic mode is set. If nonatomic mode is set, then all operations on fh_1 are sequentially consistent if they are either nonconcurrent, nonconflicting, or both.

Case 2: $fh_{1a} \in FH_1$ and $fh_{1b} \in FH_1$ Assume A_1 is a data access operation using fh_{1a} , and A_2 is a data access operation using fh_{1b} . If for any access A_1 , there is no access A_2 that conflicts with A_1 , then MPI guarantees sequential consistency.

However, unlike POSIX semantics, the default MPI semantics for conflicting accesses do not guarantee sequential consistency. If A_1 and A_2 conflict, sequential consistency can be guaranteed by either enabling atomic mode via the `MPI_FILE_SET_ATOMICITY` routine, or meeting the condition described in Case 3 below.

Case 3: $fh_1 \in FH_1$ and $fh_2 \in FH_2$ Consider access to a single file using file handles from distinct collective opens. In order to guarantee sequential consistency, `MPI_FILE_SYNC` must be used (both opening and closing a file implicitly perform an `MPI_FILE_SYNC`).

Sequential consistency is guaranteed among accesses to a single file if for any write sequence SEQ_1 to the file, there is no sequence SEQ_2 to the file which is *concurrent* with SEQ_1 . To guarantee sequential consistency when there are write sequences, `MPI_FILE_SYNC` must be used together with a mechanism that guarantees nonconcurrency of the sequences.

See the examples in Section 13.6.10, page 574, for further clarification of some of these consistency semantics.

`MPI_FILE_SET_ATOMICITY(fh, flag)`

INOUT	fh	file handle (handle)
IN	flag	true to set atomic mode, false to set nonatomic mode (logical)

`int MPI_File_set_atomicity(MPI_File fh, int flag)`

```
MPI_File_set_atomicity(fh, flag, ierror) BIND(C)
    TYPE(MPI_File), INTENT(IN) :: fh
    LOGICAL, INTENT(IN) :: flag
    INTEGER, OPTIONAL, INTENT(OUT) :: ierror
```

`MPI_FILE_SET_ATOMICITY(FH, FLAG, IERROR)`

INTEGER FH, IERROR
LOGICAL FLAG

{void MPI::File::Set_atomicity(bool flag) (*binding deprecated, see Section 15.2*) }

Let FH be the set of file handles created by one collective open. The consistency semantics for data access operations using FH is set by collectively calling

MPI_FILE_SET_ATOMICITY on *FH*. MPI_FILE_SET_ATOMICITY is collective; all processes in the group must pass identical values for *fh* and *flag*. If *flag* is true, atomic mode is set; if *flag* is false, nonatomic mode is set.

Changing the consistency semantics for an open file only affects new data accesses. All completed data accesses are guaranteed to abide by the consistency semantics in effect during their execution. Nonblocking data accesses and split collective operations that have not completed (e.g., via MPI_WAIT) are only guaranteed to abide by nonatomic mode consistency semantics.

Advice to implementors. Since the semantics guaranteed by atomic mode are stronger than those guaranteed by nonatomic mode, an implementation is free to adhere to the more stringent atomic mode semantics for outstanding requests. (*End of advice to implementors.*)

MPI_FILE_GET_ATOMICITY(*fh*, *flag*)

IN	<i>fh</i>	file handle (handle)
OUT	<i>flag</i>	true if atomic mode, false if nonatomic mode (logical)

```
int MPI_File_get_atomicity(MPI_File fh, int *flag)
```

```
MPI_File_get_atomicity(fh, flag, ierror) BIND(C)
    TYPE(MPI_File), INTENT(IN) :: fh
    LOGICAL, INTENT(OUT) :: flag
    INTEGER, OPTIONAL, INTENT(OUT) :: ierror
```

```
MPI_FILE_GET_ATOMICITY(FH, FLAG, IERROR)
    INTEGER FH, IERROR
    LOGICAL FLAG
```

```
{bool MPI::File::Get_atomicity() const(binding deprecated, see Section 15.2) }
```

MPI_FILE_GET_ATOMICITY returns the current consistency semantics for data access operations on the set of file handles created by one collective open. If *flag* is true, atomic mode is enabled; if *flag* is false, nonatomic mode is enabled.

MPI_FILE_SYNC(*fh*)

INOUT	<i>fh</i>	file handle (handle)
-------	-----------	----------------------

```
int MPI_File_sync(MPI_File fh)
```

```
MPI_File_sync(fh, ierror) BIND(C)
    TYPE(MPI_File), INTENT(IN) :: fh
    INTEGER, OPTIONAL, INTENT(OUT) :: ierror
```

```
MPI_FILE_SYNC(FH, IERROR)
    INTEGER FH, IERROR
```

```
{void MPI::File::Sync() (binding deprecated, see Section 15.2) }
```

1 Calling `MPI_FILE_SYNC` with `fh` causes all previous writes to `fh` by the calling process
2 to be transferred to the storage device. If other processes have made updates to the storage
3 device, then all such updates become visible to subsequent reads of `fh` by the calling process.
4 `MPI_FILE_SYNC` may be necessary to ensure sequential consistency in certain cases (see
5 above).

6 `MPI_FILE_SYNC` is a collective operation.

7 The user is responsible for ensuring that all nonblocking requests and split collective
8 operations on `fh` have been completed before calling `MPI_FILE_SYNC`—otherwise, the call
9 to `MPI_FILE_SYNC` is erroneous.

11 13.6.2 Random Access vs. Sequential Files

12 MPI distinguishes ordinary random access files from sequential stream files, such as pipes
13 and tape files. Sequential stream files must be opened with the `MPI_MODE_SEQUENTIAL`
14 flag set in the `amode`. For these files, the only permitted data access operations are shared
15 file pointer reads and writes. Filetypes and etypes with holes are erroneous. In addition, the
16 notion of file pointer is not meaningful; therefore, calls to `MPI_FILE_SEEK_SHARED` and
17 `MPI_FILE_GET_POSITION_SHARED` are erroneous, and the pointer update rules specified
18 for the data access routines do not apply. The amount of data accessed by a data access
19 operation will be the amount requested unless the end of file is reached or an error is raised.
20

21 *Rationale.* This implies that reading on a pipe will always wait until the requested
22 amount of data is available or until the process writing to the pipe has issued an end
23 of file. (*End of rationale.*)
24

25 Finally, for some sequential files, such as those corresponding to magnetic tapes or
26 streaming network connections, writes to the file may be destructive. In other words, a
27 write may act as a truncate (a `MPI_FILE_SET_SIZE` with `size` set to the current position)
28 followed by the write.

30 13.6.3 Progress

31 The progress rules of MPI are both a promise to users and a set of constraints on imple-
32 mentors. In cases where the progress rules restrict possible implementation choices more
33 than the interface specification alone, the progress rules take precedence.

34 All blocking routines must complete in finite time unless an exceptional condition (such
35 as resource exhaustion) causes an error.

36 Nonblocking data access routines inherit the following progress rule from nonblocking
37 point to point communication: a nonblocking write is equivalent to a nonblocking send for
38 which a receive is eventually posted, and a nonblocking read is equivalent to a nonblocking
39 receive for which a send is eventually posted.

40 Finally, an implementation is free to delay progress of collective routines until all pro-
41 cesses in the group associated with the collective call have invoked the routine. Once all
42 processes in the group have invoked the routine, the progress rule of the equivalent noncol-
43 lective routine must be followed.
44

46 13.6.4 Collective File Operations

47 Collective file operations are subject to the same restrictions as collective communication
48 operations. For a complete discussion, please refer to the semantics set forth in Section 5.13

on page 228.

Collective file operations are collective over a dup of the communicator used to open the file—this duplicate communicator is implicitly specified via the file handle argument. Different processes can pass different values for other arguments of a collective routine unless specified otherwise.

13.6.5 Type Matching

The type matching rules for I/O mimic the type matching rules for communication with one exception: if `etype` is `MPI_BYTE`, then this matches any `datatype` in a data access operation. In general, the `etype` of data items written must match the `etype` used to read the items, and for each data access operation, the current `etype` must also match the type declaration of the data access buffer.

Advice to users. In most cases, use of `MPI_BYTE` as a wild card will defeat the file interoperability features of MPI. File interoperability can only perform automatic conversion between heterogeneous data representations when the exact datatypes accessed are explicitly specified. (*End of advice to users.*)

13.6.6 Miscellaneous Clarifications

Once an I/O routine completes, it is safe to free any opaque objects passed as arguments to that routine. For example, the `comm` and `info` used in an `MPI_FILE_OPEN`, or the `etype` and `filetype` used in an `MPI_FILE_SET_VIEW`, can be freed without affecting access to the file. Note that for nonblocking routines and split collective operations, the operation must be completed before it is safe to reuse data buffers passed as arguments.

As in communication, datatypes must be committed before they can be used in file manipulation or data access operations. For example, the `etype` and `filetype` must be committed before calling `MPI_FILE_SET_VIEW`, and the `datatype` must be committed before calling `MPI_FILE_READ` or `MPI_FILE_WRITE`.

13.6.7 MPI_Offset Type

`MPI_Offset` is an integer type of size sufficient to represent the size (in bytes) of the largest file supported by MPI. Displacements and offsets are always specified as values of type `MPI_Offset`.

In Fortran, the corresponding integer is an integer `[of kind]with kind parameter MPI_OFFSET_KIND, [defined in mpif.h and the mpi module]which is defined in the mpi_f08 module, the mpi module and the mpif.h include file.`

In Fortran 77 environments that do not support `KIND` parameters, `MPI_Offset` arguments should be declared as an `INTEGER` of suitable size. The language interoperability implications for `MPI_Offset` are similar to those for addresses (see Section 16.3, page 696).

13.6.8 Logical vs. Physical File Layout

MPI specifies how the data should be laid out in a virtual file structure (the view), not how that file structure is to be stored on one or more disks. Specification of the physical file structure was avoided because it is expected that the mapping of files to disks will be system specific, and any specific control over file layout would therefore restrict program

1 portability. However, there are still cases where some information may be necessary to
 2 optimize file layout. This information can be provided as *hints* specified via *info* when a file
 3 is created (see Section 13.2.8, page 523).

4 5 13.6.9 File Size

6 The size of a file may be increased by writing to the file after the current end of file. The size
 7 may also be changed by calling MPI *size changing* routines, such as MPI_FILE_SET_SIZE. A
 8 call to a size changing routine does not necessarily change the file size. For example, calling
 9 MPI_FILE_PREALLOCATE with a size less than the current size does not change the size.
 10

11 Consider a set of bytes that has been written to a file since the most recent call to a
 12 size changing routine, or since MPI_FILE_OPEN if no such routine has been called. Let the
 13 *high byte* be the byte in that set with the largest displacement. The file size is the larger of

- 14 • One plus the displacement of the high byte.
- 15 • The size immediately after the size changing routine, or MPI_FILE_OPEN, returned.

16
 17 When applying consistency semantics, calls to MPI_FILE_SET_SIZE and
 18 MPI_FILE_PREALLOCATE are considered writes to the file (which conflict with operations
 19 that access bytes at displacements between the old and new file sizes), and
 20 MPI_FILE_GET_SIZE is considered a read of the file (which overlaps with all accesses to the
 21 file).
 22

23 *Advice to users.* Any sequence of operations containing the collective routines
 24 MPI_FILE_SET_SIZE and MPI_FILE_PREALLOCATE is a write sequence. As such,
 25 sequential consistency in nonatomic mode is not guaranteed unless the conditions in
 26 Section 13.6.1, page 569, are satisfied. (*End of advice to users.*)
 27

28 File pointer update semantics (i.e., file pointers are updated by the amount accessed)
 29 are only guaranteed if file size changes are sequentially consistent.

30
 31 *Advice to users.* Consider the following example. Given two operations made by
 32 separate processes to a file containing 100 bytes: an MPI_FILE_READ of 10 bytes and
 33 an MPI_FILE_SET_SIZE to 0 bytes. If the user does not enforce sequential consi-
 34 stency between these two operations, the file pointer may be updated by the amount
 35 requested (10 bytes) even if the amount accessed is zero bytes. (*End of advice to*
 36 *users.*)
 37

38 13.6.10 Examples

39 The examples in this section illustrate the application of the MPI consistency and semantics
 40 guarantees. These address

- 41 • conflicting accesses on file handles obtained from a single collective open, and
- 42 • all accesses on file handles obtained from two separate collective opens.

43
 44 The simplest way to achieve consistency for conflicting accesses is to obtain sequential
 45 consistency by setting atomic mode. For the code below, process 1 will read either 0 or 10
 46 integers. If the latter, every element of `b` will be 5. If nonatomic mode is set, the results of
 47 the read are undefined.
 48

```

/* Process 0 */
int i, a[10] ;
int TRUE = 1;

for ( i=0;i<10;i++)
    a[i] = 5 ;

MPI_File_open( MPI_COMM_WORLD, "workfile",
               MPI_MODE_RDWR | MPI_MODE_CREATE, MPI_INFO_NULL, &fh0 ) ;
MPI_File_set_view( fh0, 0, MPI_INT, MPI_INT, "native", MPI_INFO_NULL ) ;
MPI_File_set_atomicity( fh0, TRUE ) ;
MPI_File_write_at(fh0, 0, a, 10, MPI_INT, &status) ;
/* MPI_Barrier( MPI_COMM_WORLD ) ; */

/* Process 1 */
int b[10] ;
int TRUE = 1;
MPI_File_open( MPI_COMM_WORLD, "workfile",
               MPI_MODE_RDWR | MPI_MODE_CREATE, MPI_INFO_NULL, &fh1 ) ;
MPI_File_set_view( fh1, 0, MPI_INT, MPI_INT, "native", MPI_INFO_NULL ) ;
MPI_File_set_atomicity( fh1, TRUE ) ;
/* MPI_Barrier( MPI_COMM_WORLD ) ; */
MPI_File_read_at(fh1, 0, b, 10, MPI_INT, &status) ;

```

A user may guarantee that the write on process 0 precedes the read on process 1 by imposing temporal order with, for example, calls to `MPI_BARRIER`.

Advice to users. Routines other than `MPI_BARRIER` may be used to impose temporal order. In the example above, process 0 could use `MPI_SEND` to send a 0 byte message, received by process 1 using `MPI_RECV`. (*End of advice to users.*)

Alternatively, a user can impose consistency with nonatomic mode set:

```

/* Process 0 */
int i, a[10] ;
for ( i=0;i<10;i++)
    a[i] = 5 ;

MPI_File_open( MPI_COMM_WORLD, "workfile",
               MPI_MODE_RDWR | MPI_MODE_CREATE, MPI_INFO_NULL, &fh0 ) ;
MPI_File_set_view( fh0, 0, MPI_INT, MPI_INT, "native", MPI_INFO_NULL ) ;
MPI_File_write_at(fh0, 0, a, 10, MPI_INT, &status) ;
MPI_File_sync( fh0 ) ;
MPI_Barrier( MPI_COMM_WORLD ) ;
MPI_File_sync( fh0 ) ;

/* Process 1 */
int b[10] ;
MPI_File_open( MPI_COMM_WORLD, "workfile",

```

```

1         MPI_MODE_RDWR | MPI_MODE_CREATE, MPI_INFO_NULL, &fh1 ) ;
2 MPI_File_set_view( fh1, 0, MPI_INT, MPI_INT, "native", MPI_INFO_NULL ) ;
3 MPI_File_sync( fh1 ) ;
4 MPI_Barrier( MPI_COMM_WORLD ) ;
5 MPI_File_sync( fh1 ) ;
6 MPI_File_read_at(fh1, 0, b, 10, MPI_INT, &status ) ;

```

The “sync-barrier-sync” construct is required because:

- The barrier ensures that the write on process 0 occurs before the read on process 1.
- The first sync guarantees that the data written by all processes is transferred to the storage device.
- The second sync guarantees that all data which has been transferred to the storage device is visible to all processes. (This does not affect process 0 in this example.)

The following program represents an erroneous attempt to achieve consistency by eliminating the apparently superfluous second “sync” call for each process.

```

18 /* ----- THIS EXAMPLE IS ERRONEOUS ----- */
19 /* Process 0 */
20 int i, a[10] ;
21 for ( i=0;i<10;i++)
22     a[i] = 5 ;
23
24 MPI_File_open( MPI_COMM_WORLD, "workfile",
25               MPI_MODE_RDWR | MPI_MODE_CREATE, MPI_INFO_NULL, &fh0 ) ;
26 MPI_File_set_view( fh0, 0, MPI_INT, MPI_INT, "native", MPI_INFO_NULL ) ;
27 MPI_File_write_at(fh0, 0, a, 10, MPI_INT, &status ) ;
28 MPI_File_sync( fh0 ) ;
29 MPI_Barrier( MPI_COMM_WORLD ) ;
30
31 /* Process 1 */
32 int b[10] ;
33 MPI_File_open( MPI_COMM_WORLD, "workfile",
34               MPI_MODE_RDWR | MPI_MODE_CREATE, MPI_INFO_NULL, &fh1 ) ;
35 MPI_File_set_view( fh1, 0, MPI_INT, MPI_INT, "native", MPI_INFO_NULL ) ;
36 MPI_Barrier( MPI_COMM_WORLD ) ;
37 MPI_File_sync( fh1 ) ;
38 MPI_File_read_at(fh1, 0, b, 10, MPI_INT, &status ) ;
39
40 /* ----- THIS EXAMPLE IS ERRONEOUS ----- */

```

The above program also violates the MPI rule against out-of-order collective operations and will deadlock for implementations in which MPI_FILE_SYNC blocks.

Advice to users. Some implementations may choose to implement MPI_FILE_SYNC as a temporally synchronizing function. When using such an implementation, the “sync-barrier-sync” construct above can be replaced by a single “sync.” The results of using such code with an implementation for which MPI_FILE_SYNC is not temporally synchronizing is undefined. (*End of advice to users.*)

Asynchronous I/O

The behavior of asynchronous I/O operations is determined by applying the rules specified above for synchronous I/O operations.

The following examples all access a preexisting file “myfile.” Word 10 in myfile initially contains the integer 2. Each example writes and reads word 10.

First consider the following code fragment:

```
int a = 4, b, TRUE=1;
MPI_File_open( MPI_COMM_WORLD, "myfile",
               MPI_MODE_RDWR, MPI_INFO_NULL, &fh ) ;
MPI_File_set_view( fh, 0, MPI_INT, MPI_INT, "native", MPI_INFO_NULL ) ;
/* MPI_File_set_atomicity( fh, TRUE ) ; Use this to set atomic mode. */
MPI_File_iread_at(fh, 10, &a, 1, MPI_INT, &reqs[0]) ;
MPI_File_iread_at(fh, 10, &b, 1, MPI_INT, &reqs[1]) ;
MPI_Waitall(2, reqs, statuses) ;
```

For asynchronous data access operations, MPI specifies that the access occurs at any time between the call to the asynchronous data access routine and the return from the corresponding request complete routine. Thus, executing either the read before the write, or the write before the read is consistent with program order. If atomic mode is set, then MPI guarantees sequential consistency, and the program will read either 2 or 4 into b. If atomic mode is not set, then sequential consistency is not guaranteed and the program may read something other than 2 or 4 due to the conflicting data access.

Similarly, the following code fragment does not order file accesses:

```
int a = 4, b;
MPI_File_open( MPI_COMM_WORLD, "myfile",
               MPI_MODE_RDWR, MPI_INFO_NULL, &fh ) ;
MPI_File_set_view( fh, 0, MPI_INT, MPI_INT, "native", MPI_INFO_NULL ) ;
/* MPI_File_set_atomicity( fh, TRUE ) ; Use this to set atomic mode. */
MPI_File_iread_at(fh, 10, &a, 1, MPI_INT, &reqs[0]) ;
MPI_File_iread_at(fh, 10, &b, 1, MPI_INT, &reqs[1]) ;
MPI_Wait(&reqs[0], &status) ;
MPI_Wait(&reqs[1], &status) ;
```

If atomic mode is set, either 2 or 4 will be read into b. Again, MPI does not guarantee sequential consistency in nonatomic mode.

On the other hand, the following code fragment:

```
int a = 4, b;
MPI_File_open( MPI_COMM_WORLD, "myfile",
               MPI_MODE_RDWR, MPI_INFO_NULL, &fh ) ;
MPI_File_set_view( fh, 0, MPI_INT, MPI_INT, "native", MPI_INFO_NULL ) ;
MPI_File_iread_at(fh, 10, &a, 1, MPI_INT, &reqs[0]) ;
MPI_Wait(&reqs[0], &status) ;
MPI_File_iread_at(fh, 10, &b, 1, MPI_INT, &reqs[1]) ;
MPI_Wait(&reqs[1], &status) ;
```

defines the same ordering as:

```

1  int a = 4, b;
2  MPI_File_open( MPI_COMM_WORLD, "myfile",
3                MPI_MODE_RDWR, MPI_INFO_NULL, &fh ) ;
4  MPI_File_set_view( fh, 0, MPI_INT, MPI_INT, "native", MPI_INFO_NULL ) ;
5  MPI_File_write_at(fh, 10, &a, 1, MPI_INT, &status ) ;
6  MPI_File_read_at(fh, 10, &b, 1, MPI_INT, &status ) ;

```

Since

- nonconcurrent operations on a single file handle are sequentially consistent, and
- the program fragments specify an order for the operations,

MPI guarantees that both program fragments will read the value 4 into `b`. There is no need to set atomic mode for this example.

Similar considerations apply to conflicting accesses of the form:

```

16 MPI_File_write_all_begin(fh,...) ;
17 MPI_File_iread(fh,...) ;
18 MPI_Wait(fh,...) ;
19 MPI_File_write_all_end(fh,...) ;

```

Recall that constraints governing consistency and semantics are not relevant to the following:

```

24 MPI_File_write_all_begin(fh,...) ;
25 MPI_File_read_all_begin(fh,...) ;
26 MPI_File_read_all_end(fh,...) ;
27 MPI_File_write_all_end(fh,...) ;

```

since split collective operations on the same file handle may not overlap (see Section 13.4.5, page 550).

13.7 I/O Error Handling

By default, communication errors are fatal—`MPI_ERRORS_ARE_FATAL` is the default error handler associated with `MPI_COMM_WORLD`. I/O errors are usually less catastrophic (e.g., “file not found”) than communication errors, and common practice is to catch these errors and continue executing. For this reason, MPI provides additional error facilities for I/O.

Advice to users. MPI does not specify the state of a computation after an erroneous MPI call has occurred. A high-quality implementation will support the I/O error handling facilities, allowing users to write programs using common practice for I/O. (*End of advice to users.*)

Like communicators, each file handle has an error handler associated with it. The MPI I/O error handling routines are defined in Section 8.3, page 358.

When MPI calls a user-defined error handler resulting from an error on a particular file handle, the first two arguments passed to the file error handler are the file handle and the error code. For I/O errors that are not associated with a valid file handle (e.g., in

MPI_FILE_OPEN or MPI_FILE_DELETE), the first argument passed to the error handler is MPI_FILE_NULL,

I/O error handling differs from communication error handling in another important aspect. By default, the predefined error handler for file handles is MPI_ERRORS_RETURN. The default file error handler has two purposes: when a new file handle is created (by MPI_FILE_OPEN), the error handler for the new file handle is initially set to the default error handler, and I/O routines that have no valid file handle on which to raise an error (e.g., MPI_FILE_OPEN or MPI_FILE_DELETE) use the default file error handler. The default file error handler can be changed by specifying MPI_FILE_NULL as the fh argument to MPI_FILE_SET_ERRHANDLER. The current value of the default file error handler can be determined by passing MPI_FILE_NULL as the fh argument to MPI_FILE_GET_ERRHANDLER.

Rationale. For communication, the default error handler is inherited from MPI_COMM_WORLD. In I/O, there is no analogous “root” file handle from which default properties can be inherited. Rather than invent a new global file handle, the default file error handler is manipulated as if it were attached to MPI_FILE_NULL. (*End of rationale.*)

13.8 I/O Error Classes

The implementation dependent error codes returned by the I/O routines can be converted into the error classes defined in Table 13.3.

In addition, calls to routines in this chapter may raise errors in other MPI classes, such as MPI_ERR_TYPE.

13.9 Examples

13.9.1 Double Buffering with Split Collective I/O

This example shows how to overlap computation and output. The computation is performed by the function `compute_buffer()`.

```

/*=====
*
* Function:          double_buffer
*
* Synopsis:
*   void double_buffer(
*       MPI_File fh,                ** IN
*       MPI_Datatype buftype,      ** IN
*       int bufcount                ** IN
*   )
*
* Description:
*   Performs the steps to overlap computation with a collective write
*   by using a double-buffering technique.
*

```

1		
2		
3		
4		
5		
6		
7		
8		
9		
10		
11	MPI_ERR_FILE	Invalid file handle
12	MPI_ERR_NOT_SAME	Collective argument not identical on all
13		processes, or collective routines called in
14		a different order by different processes
15	MPI_ERR_AMODE	Error related to the <code>amode</code> passed to
16		<code>MPI_FILE_OPEN</code>
17	MPI_ERR_UNSUPPORTED_DATAREP	Unsupported <code>datarep</code> passed to
18		<code>MPI_FILE_SET_VIEW</code>
19	MPI_ERR_UNSUPPORTED_OPERATION	Unsupported operation, such as seeking on
20		a file which supports sequential access only
21	MPI_ERR_NO_SUCH_FILE	File does not exist
22	MPI_ERR_FILE_EXISTS	File exists
23	MPI_ERR_BAD_FILE	Invalid file name (e.g., path name too long)
24	MPI_ERR_ACCESS	Permission denied
25	MPI_ERR_NO_SPACE	Not enough space
26	MPI_ERR_QUOTA	Quota exceeded
27	MPI_ERR_READ_ONLY	Read-only file or file system
28	MPI_ERR_FILE_IN_USE	File operation could not be completed, as
29		the file is currently open by some process
30	MPI_ERR_DUP_DATAREP	Conversion functions could not be regis-
31		tered because a data representation identi-
32		fier that was already defined was passed to
33		<code>MPI_REGISTER_DATAREP</code>
34	MPI_ERR_CONVERSION	An error occurred in a user supplied data
35		conversion function.
36	MPI_ERR_IO	Other I/O error
37		

Table 13.3: I/O Error Classes

38
39
40
41
42
43
44
45
46
47
48

```

* Parameters:
*     fh                previously opened MPI file handle
*     buftype           MPI datatype for memory layout
*                       (Assumes a compatible view has been set on fh)
*     bufcount          # buftype elements to transfer
*-----*/
/* this macro switches which buffer "x" is pointing to */
#define TOGGLE_PTR(x) ((x)==(buffer1)) ? (x=buffer2) : (x=buffer1)

void double_buffer( MPI_File fh, MPI_Datatype buftype, int bufcount)
{
    MPI_Status status;          /* status for MPI calls */
    float *buffer1, *buffer2;  /* buffers to hold results */
    float *compute_buf_ptr;    /* destination buffer */
                                /* for computing */
    float *write_buf_ptr;      /* source for writing */
    int done;                  /* determines when to quit */

    /* buffer initialization */
    buffer1 = (float *)
                malloc(bufcount*sizeof(float)) ;
    buffer2 = (float *)
                malloc(bufcount*sizeof(float)) ;
    compute_buf_ptr = buffer1 ; /* initially point to buffer1 */
    write_buf_ptr   = buffer1 ; /* initially point to buffer1 */

    /* DOUBLE-BUFFER prolog:
     * compute buffer1; then initiate writing buffer1 to disk
     */
    compute_buffer(compute_buf_ptr, bufcount, &done);
    MPI_File_write_all_begin(fh, write_buf_ptr, bufcount, buftype);

    /* DOUBLE-BUFFER steady state:
     * Overlap writing old results from buffer pointed to by write_buf_ptr
     * with computing new results into buffer pointed to by compute_buf_ptr.
     *
     * There is always one write-buffer and one compute-buffer in use
     * during steady state.
     */
    while (!done) {
        TOGGLE_PTR(compute_buf_ptr);
        compute_buffer(compute_buf_ptr, bufcount, &done);
        MPI_File_write_all_end(fh, write_buf_ptr, &status);
        TOGGLE_PTR(write_buf_ptr);
        MPI_File_write_all_begin(fh, write_buf_ptr, bufcount, buftype);
    }
}

```

```

1     }
2
3     /* DOUBLE-BUFFER epilog:
4      *   wait for final write to complete.
5      */
6     MPI_File_write_all_end(fh, write_buf_ptr, &status);
7
8
9     /* buffer cleanup */
10    free(buffer1);
11    free(buffer2);
12 }

```

13.9.2 Subarray Filetype Constructor

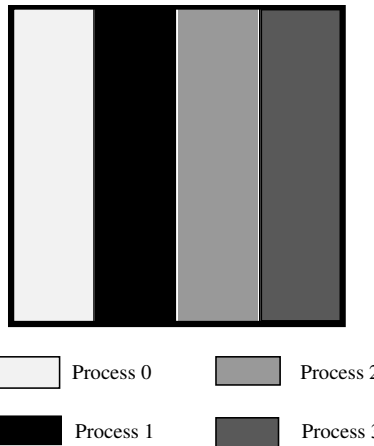

Figure 13.4: Example array file layout

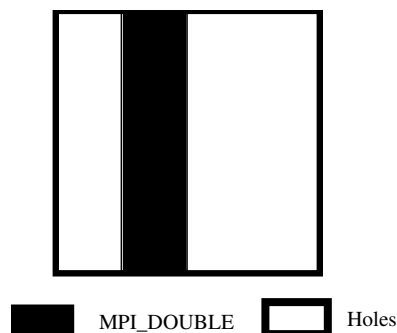

Figure 13.5: Example local array filetype for process 1

Assume we are writing out a 100x100 2D array of double precision floating point numbers that is distributed among 4 processes such that each process has a block of 25 columns (e.g., process 0 has columns 0-24, process 1 has columns 25-49, etc.; see Figure 13.4). To create the filetypes for each process one could use the following C program (see Section 4.1.3 on page 103):

```

double subarray[100][25];
MPI_Datatype filetype;
int sizes[2], subsizes[2], starts[2];
int rank;

MPI_Comm_rank(MPI_COMM_WORLD, &rank);
sizes[0]=100; sizes[1]=100;
subsizes[0]=100; subsizes[1]=25;
starts[0]=0; starts[1]=rank*subsizes[1];

MPI_Type_create_subarray(2, sizes, subsizes, starts, MPI_ORDER_C,
                        MPI_DOUBLE, &filetype);

```

Or, equivalently in Fortran:

```

double precision subarray(100,25)
integer filetype, rank, ierror
integer sizes(2), subsizes(2), starts(2)

call MPI_COMM_RANK(MPI_COMM_WORLD, rank, ierror)
sizes(1)=100
sizes(2)=100
subsizes(1)=100
subsizes(2)=25
starts(1)=0
starts(2)=rank*subsizes(2)

call MPI_TYPE_CREATE_SUBARRAY(2, sizes, subsizes, starts, &
                             MPI_ORDER_FORTRAN, MPI_DOUBLE_PRECISION, &
                             filetype, ierror)

```

The generated filetype will then describe the portion of the file contained within the process's subarray with holes for the space taken by the other processes. Figure 13.5 shows the filetype created for process 1.

1
2
3
4
5
6
7
8
9
10
11
12
13
14
15
16
17
18
19
20
21
22
23
24
25
26
27
28
29
30
31
32
33
34
35
36
37
38
39
40
41
42
43
44
45
46
47
48

1
2 ticket266.
3
4
5
6
7
8
9
10
11
12
13
14
15
16
17
18
19
20
21
22
23
24
25
26
27
28
29
30
31
32
33
34
35
36
37
38
39
40
41
42
43
44
45
46
47
48

Chapter 14

Tool Support

14.1 Introduction

This chapter discusses a set of interfaces that allows debuggers, performance analyzers, and other tools to extract information about the operation of MPI processes. Specifically, this chapter defines both the MPI profiling interface (Section 14.2), which supports the transparent interception and inspection of MPI calls, and the MPI tool information interface (Section 14.3), which supports the inspection and manipulation of MPI control and performance variables. The interfaces described in this chapter are all defined in the context of an MPI process, i.e., are callable from the same code that invokes other MPI functions.

14.2 Profiling Interface

[WAS: Chapter]

14.2.1 Requirements

[WAS: Section]

To meet [the]the requirements for the MPI profiling interface, an implementation of the MPI functions *must*

1. provide a mechanism through which all of the MPI defined [functions]functions, except those allowed as macros (See Section 2.6.5[]), may be accessed with a name shift. This requires, in C and Fortran, an alternate entry point name, with the prefix `PMPI_` for each MPI function in each provided language binding and language support method. The profiling interface in C++ is described in Section 16.1.10. For routines implemented as macros, it is still required that the `PMPI_` version be supplied and work as expected, but it is not possible to replace at link time the `MPI_` version with a user-defined version.

For Fortran, the different support methods cause several linker names. Therefore, several profiling routines (with these linker names) are needed for each Fortran MPI routine, as described in Section 16.2.5 on page 653.

2. ensure that those MPI functions that are not replaced may still be linked into an executable image without causing name clashes.

3. document the implementation of different language bindings of the MPI interface if they are layered on top of each other, so that the profiler developer knows whether she must implement the profile interface for each binding, or can [economise]economize by implementing it only for the lowest level routines.

4. where the implementation of different language bindings is done through a layered approach ([e.g.]e.g., the Fortran binding is a set of “wrapper” functions that call the C implementation), ensure that these wrapper functions are separable from the rest of the library.

This separability is necessary to allow a separate profiling library to be correctly implemented, since (at least with Unix linker semantics) the profiling library must contain these wrapper functions if it is to perform as expected. This requirement allows the person who builds the profiling library to extract these functions from the original MPI library and add them into the profiling library without bringing along any other unnecessary code.

5. provide a no-op routine `MPI_PCONTROL` in the MPI library.

14.2.2 Discussion

[WAS: Section]

The objective of the MPI profiling interface is to ensure that it is relatively easy for authors of profiling (and other similar) tools to interface their codes to MPI implementations on different machines.

Since MPI is a machine independent standard with many different implementations, it is unreasonable to expect that the authors of profiling tools for MPI will have access to the source code that implements MPI on any particular machine. It is therefore necessary to provide a mechanism by which the implementors of such tools can collect whatever performance information they wish *without* access to the underlying implementation.

We believe that having such an interface is important if MPI is to be attractive to end users, since the availability of many different tools will be a significant factor in attracting users to the MPI standard.

The profiling interface is just that, an interface. It says *nothing* about the way in which it is used. There is therefore no attempt to lay down what information is collected through the interface, or how the collected information is saved, filtered, or displayed.

While the initial impetus for the development of this interface arose from the desire to permit the implementation of profiling tools, it is clear that an interface like that specified may also prove useful for other purposes, such as “internetworking” multiple MPI implementations. Since all that is defined is an interface, there is no objection to its being used wherever it is useful.

As the issues being addressed here are intimately tied up with the way in which executable images are built, which may differ greatly on different machines, the examples given below should be treated solely as one way of implementing the objective of the MPI profiling interface. The actual requirements made of an implementation are those detailed in the Requirements section above, the whole of the rest of this chapter is only present as justification and discussion of the logic for those requirements.

1 The examples below show one way in which an implementation could be constructed to
 2 meet the requirements on a Unix system (there are doubtless others that would be equally
 ticket266. 3 valid).

4 14.2.3 Logic of the Design

5 [WAS: Section]

6 Provided that an MPI implementation meets the requirements above, it is possible for
 7 the implementor of the profiling system to intercept all of the MPI calls that are made by
 8 the user program. She can then collect whatever information she requires before calling
 9 the underlying MPI implementation (through its name shifted entry points) to achieve the
 10 desired effects.
 ticket266. 11

12 14.2.4 Miscellaneous Control of Profiling

13 [WAS: Subsection, Now still a subsection to remove single subsection]

14 There is a clear requirement for the user code to be able to control the profiler dynam-
 15 ically at run time. This is normally used for (at least) the purposes of

- 16 • Enabling and disabling profiling depending on the state of the calculation.
- 17 ticket0. 18 • Flushing trace buffers at non-critical points in the [calculation]calculation.
- 19 • Adding user events to a trace file.

20 These requirements are met by use of the MPI_PCONTROL.

21 MPI_PCONTROL(level, ...)

22 IN level Profiling level

23 int MPI_Pcontrol(const int level, ...)

24 MPI_Pcontrol(level) BIND(C)
 25 INTEGER, INTENT(IN) :: level

26 MPI_PCONTROL(LEVEL)
 27 INTEGER LEVEL

28 {void MPI::Pcontrol(const int level, ...) (binding deprecated, see Section 15.2) }

29 MPI libraries themselves make no use of this routine, and simply return immediately
 30 to the user code. However the presence of calls to this routine allows a profiling package to
 31 be explicitly called by the user.

32 Since MPI has no control of the implementation of the profiling code, we are unable
 33 to specify precisely the semantics that will be provided by calls to MPI_PCONTROL. This
 34 vagueness extends to the number of arguments to the function, and their datatypes.

35 However to provide some level of portability of user codes to different profiling libraries,
 36 we request the following meanings for certain values of level.

- 37 • level==0 Profiling is disabled.

- `level==1` Profiling is enabled at a normal default level of detail.
- `level==2` Profile buffers are `[flushed. (This may be a no-op in some profilers).]flushed, which may be a no-op in some profilers.`
- All other values of `level` have profile library defined effects and additional arguments.

We also request that the default state after `MPI_INIT` has been called is for profiling to be enabled at the normal default level. (i.e. as if `MPI_PCONTROL` had just been called with the argument 1). This allows users to link with a profiling library and obtain profile output without having to modify their source code at all.

The provision of `MPI_PCONTROL` as a no-op in the standard MPI library `[allows them to modify their source code to obtain]supports the collection of` more detailed profiling information`[, but still be able to link exactly the]with source [same code]code that can still link` against the standard MPI library.

`[WAS: Subsection Examples]`

14.2.5 Profiler Implementation `[]Example`

`[Suppose that the profiler wishes to]A profiler can` accumulate the total amount of data sent by the `[MPI_SEND]MPI_SEND` function, along with the total elapsed time spent in the `[function. This could trivially be achieved thus]function, as follows:`

```
static int totalBytes = 0;
static double totalTime = 0.0;

int MPI_Send(void* buffer, int count, MPI_Datatype datatype,
             int dest, int tag, MPI_Comm comm)
{
    double tstart = MPI_Wtime();      /* Pass on all the arguments */
    int extent;
    int result = PMPI_Send(buffer, count, datatype, dest, tag, comm);

    MPI_Type_size(datatype, &extent); /* Compute size */
    totalBytes += count*extent;

    totalTime += MPI_Wtime() - tstart; /* and time */

    return result;
}
```

14.2.6 MPI Library Implementation `[]Example`

`[On a Unix system, in which the MPI library is implemented in C, then]If the MPI library is implemented in C on a Unix system, then there [there are various possible options, of which two of the most obvious]are various options, including the two presented here, for supporting [are presented here. Which is better depends on whether the linker and]the name-shift requirement. The choice between these two options [compiler support weak symbols.]depends partly on whether the linker and compiler support weak symbols.`

Systems with Weak Symbols

ticket0. If the compiler and linker support weak external symbols ([e.g.]e.g., Solaris 2.x, other system V.4 machines), then only a single library is required through the use of `#pragma weak` thus

```
#pragma weak MPI_Example = PMPI_Example

int PMPI_Example(/* appropriate args */)
{
    /* Useful content */
}
```

The effect of this `#pragma` is to define the external symbol `MPI_Example` as a weak definition. This means that the linker will not complain if there is another definition of the symbol (for instance in the profiling library), however if no other definition exists, then the linker will use the weak definition.

Systems Without Weak Symbols

In the absence of weak symbols then one possible solution would be to use the C macro pre-processor thus

```
#ifdef PROFILELIB
#   ifdef __STDC__
#       define FUNCTION(name) P##name
#   else
#       define FUNCTION(name) P/**/name
#   endif
#else
#   define FUNCTION(name) name
#endif
```

Each of the user visible functions in the library would then be declared thus

```
int FUNCTION(MPI_Example)(/* appropriate args */)
{
    /* Useful content */
}
```

The same source file can then be compiled to produce both versions of the library, depending on the state of the `PROFILELIB` macro symbol.

It is required that the standard MPI library be built in such a way that the inclusion of MPI functions can be achieved one at a time. This is a somewhat unpleasant requirement, since it may mean that each external function has to be compiled from a separate file. However this is necessary so that the author of the profiling library need only define those MPI functions that she wishes to intercept, references to any others being fulfilled by the normal MPI library. Therefore the link step can look something like this

```
% cc ... -lmyprof -lpmpi -lmpi
```

Here `libmyprof.a` contains the profiler functions that intercept some of the MPI functions[,], `libpmpi.a` contains the “name shifted” MPI functions, and `libmpi.a` contains the normal definitions of the MPI functions.

14.2.7 Complications

Multiple Counting

Since parts of the MPI library may themselves be implemented using more basic MPI functions ([e.g.]e.g., a portable implementation of the collective operations implemented using point to point communications), there is potential for profiling functions to be called from within an MPI function that was called from a profiling function. This could lead to “double counting” of the time spent in the inner routine. Since this effect could actually be useful under some circumstances ([e.g.]e.g., it might allow one to answer the question “How much time is spent in the point to point routines when they’re called from collective functions?”), we have decided not to enforce any restrictions on the author of the MPI library that would overcome this. Therefore the author of the profiling library should be aware of this problem, and guard against it herself. In a single threaded world this is easily achieved through use of a static variable in the profiling code that remembers if you are already inside a profiling routine. It becomes more complex in a multi-threaded environment (as does the meaning of the times recorded[!]).

Linker Oddities

The Unix linker traditionally operates in one [pass :]pass: the effect of this is that functions from libraries are only included in the image if they are needed at the time the library is scanned. When combined with weak symbols, or multiple definitions of the same function, this can cause odd (and unexpected) effects.

Consider, for instance, an implementation of MPI in which the Fortran binding is achieved by using wrapper functions on top of the C implementation. The author of the profile library then assumes that it is reasonable only to provide profile functions for the C binding, since Fortran will eventually call these, and the cost of the wrappers is assumed to be small. However, if the wrapper functions are not in the profiling library, then none of the profiled entry points will be undefined when the profiling library is called. Therefore none of the profiling code will be included in the image. When the standard MPI library is scanned, the Fortran wrappers will be resolved, and will also pull in the base versions of the MPI functions. The overall effect is that the code will link successfully, but will not be profiled.

To overcome this we must ensure that the Fortran wrapper functions are included in the profiling version of the library. We ensure that this is possible by requiring that these be separable from the rest of the base MPI library. This allows them to be aared out of the base library and into the profiling one.

Fortran Support Methods

The different Fortran support methods and possible options for the support of subarrays (depending on whether the compiler can support TYPE(*), DIMENSION(..) choice buffers) imply different linker names for the same Fortran MPI routine. The rules and implications for the profiling interface are described in Section 16.2.5 on page 653.

14.2.8 Multiple Levels of Interception

[WAS: Section] The scheme given here does not directly support the nesting of profiling functions, since it provides only a single alternative name for each MPI function. Consideration was given to an implementation that would allow multiple levels of call interception, however we were unable to construct an implementation of this that did not have the following disadvantages

- assuming a particular implementation language[.],
- imposing a run time cost even when no profiling was taking place.

Since one of the objectives of MPI is to permit efficient, low latency implementations, and it is not the business of a standard to require a particular implementation language, we decided to accept the scheme outlined above.

[Note, however, that it is possible to use the scheme above to implement a multi-level system, since the function called by the user may call many different profiling functions before calling the underlying MPI function.]

[Unfortunately such an implementation may require more cooperation between the different profiling libraries than is required for the single level implementation detailed above.]Note, however, that it is possible to use the scheme above to implement a multi-level system, since the function called by the user may call many different profiling functions before calling the underlying MPI function. This capability has been demonstrated in the P^NMPI tool infrastructure [51].

14.3 The MPI Tool Information Interface

MPI implementations often use internal variables to control their operation and performance. Understanding and manipulating these variables can provide a more efficient execution environment or improve performance for many applications. This section describes the MPI tool information interface, which provides a mechanism for MPI implementors to expose a set of variables, each of which represents a particular property, setting, or performance measurement from within the MPI implementation. The interface is split into two parts: the first part provides information about and supports the setting of control variables through which the MPI implementation tunes its configuration. The second part provides access to performance variables that can provide insight into internal performance information of the MPI implementation.

To avoid restrictions on the MPI implementation, the MPI tool information interface allows the implementation to specify which control and performance variables exist. Additionally, the user of the MPI tool information interface can obtain metadata about each available variable, such as its datatype, and a textual description. The MPI tool information interface provides the necessary routines to find all variables that exist in a particular MPI implementation, to query their properties, to retrieve descriptions about their meaning, and to access and, if appropriate, to alter their values.

The MPI tool information interface can be used independently from the MPI communication functionality. In particular, the routines of this interface can be called before MPI_INIT (or equivalent) and after MPI_FINALIZE. In order to support this behavior cleanly, the MPI tool information interface uses separate initialization and finalization routines. All identifiers used in the MPI tool information interface have the prefix MPI_T_.

On success, all MPI tool information interface routines return MPI_SUCCESS, otherwise they return an appropriate and unique return code indicating the reason why the call was

not successfully completed. Details on return codes can be found in Section 14.3.9. However, unsuccessful calls to the MPI tool information interface are not fatal and do not impact the execution of subsequent MPI routines.

Since the MPI tool information interface primarily focuses on tools and support libraries, MPI implementations are only required to provide C bindings for functions introduced in this Section 14.3. Except where otherwise noted, all conventions and principles governing the C bindings of the MPI API also apply to the MPI tool information interface, which is available by including the `mpi.h` header file. All routines in this interface have local semantics.

Advice to users. The number and type of control variables and performance variables can vary between MPI implementations, platforms and different builds of the same implementation on the same platform as well as between runs. Hence, any application relying on a particular variable will not be portable. Further, there is no guarantee that number of variables, variable indices, and variable names are the same across processes.

This interface is primarily intended for performance monitoring tools, support tools, and libraries controlling the application's environment. When maximum portability is desired, application programmers should either avoid using the MPI tool information interface or avoid being dependent on the existence of a particular control or performance variable. (*End of advice to users.*)

14.3.1 Verbosity Levels

The MPI tool information interface provides access to internal configuration and performance information through a set of control and performance variables defined by the MPI implementation. Since some implementations may export a large number of variables, variables are classified by a verbosity level that categorizes both their intended audience (end users, performance tuners or MPI implementors) and a relative measure of level of detail (basic, detailed or all). These verbosity levels are described by a single integer. Table 14.1 lists the constants for all possible verbosity levels. The values of the constants are monotonic in the order listed in the table; i.e., `MPI_T_VERBOSITY_USER_BASIC < MPI_T_VERBOSITY_USER_DETAIL < ... < MPI_T_VERBOSITY_MPIDEV_ALL`.

<code>MPI_T_VERBOSITY_USER_BASIC</code>	Basic information of interest to users
<code>MPI_T_VERBOSITY_USER_DETAIL</code>	Detailed information of interest to users
<code>MPI_T_VERBOSITY_USER_ALL</code>	All information of interest to users
<code>MPI_T_VERBOSITY_TUNER_BASIC</code>	Basic information required for tuning
<code>MPI_T_VERBOSITY_TUNER_DETAIL</code>	Detailed information required for tuning
<code>MPI_T_VERBOSITY_TUNER_ALL</code>	All information required for tuning
<code>MPI_T_VERBOSITY_MPIDEV_BASIC</code>	Basic information for MPI implementors
<code>MPI_T_VERBOSITY_MPIDEV_DETAIL</code>	Detailed information for MPI implementors
<code>MPI_T_VERBOSITY_MPIDEV_ALL</code>	All information for MPI implementors

Table 14.1: MPI tool information interface verbosity levels.

14.3.2 Binding MPI Tool Information Interface Variables to MPI Objects

Each MPI tool information interface variable provides access to a particular control setting or performance property of the MPI implementation. A variable may refer to a specific MPI object such as a communicator, datatype, or one-sided communication window, or the variable may refer more generally to the MPI environment of the process. Except for the last case, the variable must be bound to exactly one MPI object before it can be used. Table 14.2 lists all MPI object types to which an MPI tool information interface variable can be bound, together with the matching constant that MPI tool information interface routines return to identify the object type.

Constant	MPI object
MPI_T_BIND_NO_OBJECT	N/A; applies globally to entire MPI process
MPI_T_BIND_MPI_COMM	MPI communicators
MPI_T_BIND_MPI_DATATYPE	MPI datatypes
MPI_T_BIND_MPI_ERRHANDLER	MPI error handlers
MPI_T_BIND_MPI_FILE	MPI file handles
MPI_T_BIND_MPI_GROUP	MPI groups
MPI_T_BIND_MPI_OP	MPI reduction operators
MPI_T_BIND_MPI_REQUEST	MPI requests
MPI_T_BIND_MPI_WIN	MPI windows for one-sided communication
MPI_T_BIND_MPI_MESSAGE	MPI message object
MPI_T_BIND_MPI_INFO	MPI info object

Table 14.2: Constants to identify associations of variables.

Rationale. Some variables have meanings tied to a specific MPI object. Examples include the number of send or receive operations using a particular datatype, the number of times a particular error handler has been called, or the communication protocol and “eager limit” used for a particular communicator. Creating a new MPI tool information interface variable for each MPI object would cause the number of variables to grow without bounds, since they cannot be reused to avoid naming conflicts. By associating MPI tool information interface variables with a specific MPI object, the MPI implementation only must specify and maintain a single variable, which can then be applied to as many MPI objects of the respective type as created during the program’s execution. (*End of rationale.*)

14.3.3 Convention for Returning Strings

Several MPI tool information interface functions return one or more strings. These functions have two arguments for each string to be returned: an OUT parameter that identifies a pointer to the buffer in which the string will be returned, and an IN/OUT parameter to pass the length of the buffer. The user is responsible for the memory allocation of the buffer and must pass the size of the buffer (n) as the length argument. Let n be the length value specified to the function. On return, the function writes at most $n - 1$ of the string’s characters into the buffer, followed by a null terminator. If the returned string’s length is greater than or equal to n , the string will be truncated to $n - 1$ characters. In this case, the length of the string plus one (for the terminating null character) is returned in the length

argument. If the user passes the null pointer as the buffer argument or passes 0 as the length argument, the function does not return the string and only returns the length of the string plus one in the length argument. If the user passes the null pointer as the length argument, the buffer argument is ignored and nothing is returned.

14.3.4 Initialization and Finalization

The MPI tool information interface requires a separate set of initialization and finalization routines.

`MPI_T_INIT_THREAD(required, provided)`

IN	required	desired level of thread support (integer)
OUT	provided	provided level of thread support (integer)

`int MPI_T_init_thread(int required, int *provided)`

All programs or tools that use the MPI tool information interface must initialize the MPI tool information interface in the processes that will use the interface before calling any other of its routines. A user can initialize the MPI tool information interface by calling `MPI_T_INIT_THREAD`, which can be called multiple times. In addition, this routine initializes the thread environment for all routines in the MPI tool information interface. Calling this routine when the MPI tool information interface is already initialized has no effect beyond increasing the reference count of how often the interface has been initialized. The argument `required` is used to specify the desired level of thread support. The possible values and their semantics are identical to the ones that can be used with `MPI_INIT_THREAD` listed in Section 12.4. The call returns in `provided` information about the actual level of thread support that will be provided by the MPI implementation for calls to MPI tool information interface routines. It can be one of the four values listed in Section 12.4.

The MPI specification does not require all MPI processes to exist before the call to `MPI_INIT`. If the MPI tool information interface is used before `MPI_INIT` has been called, `MPI_T_INIT_THREAD` must be called on each process that will use the MPI tool information interface. Processes created by the MPI implementation during `MPI_INIT` inherit the status of the MPI tool information interface (whether it is initialized or not as well as all active sessions and handles) from the process from which they are created.

Processes created at runtime as a result of calls MPI's dynamic process management require their own initialization before they can use the MPI tool information interface.

Advice to users. If `MPI_T_INIT_THREAD` is called before `MPI_INIT_THREAD`, the requested and granted thread level for `MPI_T_INIT_THREAD` may influence the behavior and return value of `MPI_INIT_THREAD`. The same is true for the reverse order. (*End of advice to users.*)

Advice to implementors. MPI implementations should strive to make as many control or performance variables available before `MPI_INIT` (instead of adding them within `MPI_INIT`) to allow tools the most flexibility. In particular, control variables should be available before `MPI_INIT` if their value cannot be changed after `MPI_INIT`. (*End of advice to implementors.*)

1 MPI_T_FINALIZE()

2
3 int MPI_T_finalize(void)

4 This routine finalizes the use of the MPI tool information interface and may be called
5 as often as the corresponding MPI_T_INIT_THREAD routine up to the current point of
6 execution. Calling it more times returns a corresponding error code. As long as the number
7 of calls to MPI_T_FINALIZE is smaller than the number of calls to MPI_T_INIT_THREAD
8 up to the current point of execution, the MPI tool information interface remains initialized
9 and calls to its routines are permissible. Further, additional calls to MPI_T_INIT_THREAD
10 after one or more calls to MPI_T_FINALIZE are permissible.

11 Once MPI_T_FINALIZE is called the same number of times as the routine
12 MPI_T_INIT_THREAD up to the current point of execution, the MPI tool information in-
13 terface is no longer initialized. The interface can be reinitialized by subsequent calls to
14 MPI_T_INIT_THREAD.

15 At the end of the program execution, unless MPI_ABORT is called, an application must
16 have called MPI_T_INIT_THREAD and MPI_T_FINALIZE an equal number of times.
17

18 14.3.5 Datatype System

19 All variables managed through the MPI tool information interface represent their values
20 through typed buffers of a given length and type using an MPI datatype (similar to regular
21 send/receive buffers). Since the initialization of the MPI tool information interface is sep-
22 arate from the initialization of MPI, MPI tool information interface routines can be called
23 before MPI_INIT. Consequently, these routines can also use MPI datatypes before MPI_INIT.
24 Therefore, within the context of the MPI tool information interface, it is permissible to use
25 a subset of MPI datatypes as specified below before a call to MPI_INIT (or equivalent).
26

```
27
28 MPI_INT
29 MPI_UNSIGNED
30 MPI_UNSIGNED_LONG
31 MPI_UNSIGNED_LONG_LONG
32 MPI_COUNT
33 MPI_CHAR
34 MPI_DOUBLE
35
```

36 Table 14.3: MPI datatypes that can be used by the MPI tool information interface.

37
38
39 *Rationale.* The MPI tool information interface relies mainly on unsigned datatypes
40 for integer values since most variables are expected to represent counters or resource
41 sizes. MPI_INT is provided for additional flexibility and is expected to be used mainly
42 for control variables and enumeration types (see below).
43

44 Providing all basic datatypes, in particular providing all signed and unsigned variants
45 of integer types, would lead to a larger number of types, which tools need to interpret.
46 This would cause unnecessary complexity in the implementation of tools based on the
47 MPI tool information interface. (*End of rationale.*)
48

The MPI tool information interface only relies on a subset of the basic MPI datatypes and does not use any derived MPI datatypes. Table 14.3 lists all MPI datatypes that can be returned by the MPI tool information interface to represent its variables.

Rationale. The MPI tool information interface requires a significantly simpler type system than MPI itself. Therefore, only its required subset must be present before MPI_INIT (or equivalent) and MPI implementations do not need to initialize the complete MPI datatype system. (*End of rationale.*)

For variables of type MPI_INT, an MPI implementation can provide additional information by associating names with a fixed number of values. We refer to this information in the following as an enumeration. In this case, the respective calls that provide additional metadata for each control or performance variable, i.e., MPI_T_CVAR_GET_INFO (Section 14.3.6) and MPI_T_PVAR_GET_INFO (Section 14.3.7), return a handle of type MPI_T_enum that can be passed to the following functions to extract additional information. Thus, the MPI implementation can describe variables with a fixed set of values that each represents a particular state. Each enumeration type can have N different values, with a fixed N that can be queried using MPI_T_ENUM_GET_INFO.

MPI_T_ENUM_GET_INFO(enumtype, num, name, name_len)

IN	enumtype	enumeration to be queried (handle)
OUT	num	number of discrete values represented by this enumeration (integer)
OUT	name	buffer to return the string containing the name of the enumeration (string)
INOUT	name_len	length of the string and/or buffer for name (integer)

```
int MPI_T_enum_get_info(MPI_T_enum enumtype, int *num, char *name, int
                        *name_len)
```

If enumtype is a valid enumeration, this routine returns the number of items represented by this enumeration type. range and the name of the enumeration. N must be greater than 0, i.e., the enumeration must represent at least one value.

The arguments name and name_len are used to return the name of the enumerations as described in Section 14.3.3.

The routine is required to return a name of at least length one. This name must be unique with respect to all other names for enumerations that the MPI implementation uses.

Names associated with individual values in each enumeration enumtype can be queried using MPI_T_ENUM_GET_ITEM.

```

1 MPI_T_ENUM_GET_ITEM(enumtype, index, value, name, name_len)
2     IN      enumtype      enumeration to be queried (handle)
3     IN      index         number of the value to be queried in this enumeration
4                          (integer)
5     OUT     value         variable value (integer)
6     OUT     name          buffer to return the string containing the name of the
7                          enumeration item (string)
8     INOUT   name_len      length of the string and/or buffer for name (integer)
9
10
11

```

```

12 int MPI_T_enum_get_item(MPI_T_enum enumtype, int index, int value, char
13                        *name, int *name_len)
14
15

```

The arguments `name` and `name_len` are used to return the name of the enumeration item as described in Section 14.3.3.

If completed successfully, the routine returns the name/value pair describing the enumeration at the specified index. The call is further required to return a name of at least length one. This name must be unique with respect to all other names of items for the same enumeration.

14.3.6 Control Variables

The routines described in this section of the MPI tool information interface specification focus on the ability to list, query, and possibly set control variables exposed by the MPI implementation. These variables can typically be used by the user to fine tune properties and configuration settings of the MPI implementation. On many systems, such variables can be set using environment variables, although other configuration mechanisms may be available, such as configuration files or central configuration registries. A typical example that is available in several existing MPI implementations is the ability to specify an “eager limit”, i.e., an upper bound on the size of messages sent or received using an eager protocol.

Control Variable Query Functions

An MPI implementation exports a set of N control variables through the MPI tool information interface. If N is zero, then the MPI implementation does not export any control variables, otherwise the provided control variables are indexed from 0 to $N - 1$. This index number is used in subsequent calls to identify the individual variables.

An MPI implementation is allowed to increase the number of control variables during the execution of an MPI application when new variables become available through dynamic loading. However, MPI implementations are not allowed to change the index of a control variable or delete a variable once it has been added to the set. When variables become inactive, e.g., through dynamic unloading, accessing its value should return a corresponding error code.

Advice to users. While the MPI tool information interface guarantees that indices or variable properties do not change during a particular run of an MPI program, it does not provide a similar guarantee between runs. (*End of advice to users.*)

The following function can be used to query the number of control variables, *num_cvar*:

```
MPI_T_CVAR_GET_NUM(num_cvar)
```

OUT	num_cvar	returns number of control variables (integer)
-----	----------	---

```
int MPI_T_cvar_get_num(int *num_cvar)
```

The function `MPI_T_CVAR_GET_INFO` provides access to additional information for each variable.

```
MPI_T_CVAR_GET_INFO(cvar_index, name, name_len, verbosity, datatype, enumtype, desc,
                    desc_len, bind, scope)
```

IN	cvar_index	index of the control variable to be queried, value between 0 and <i>num_cvar</i> - 1 (integer)
OUT	name	buffer to return the string containing the name of the control variable (string)
INOUT	name_len	length of the string and/or buffer for <i>name</i> (integer)
OUT	verbosity	verbosity level of this variable (integer)
OUT	datatype	MPI datatype of the information stored in the control variable (handle)
OUT	enumtype	optional descriptor for enumeration information (handle)
OUT	desc	buffer to return the string containing a description of the control variable (string)
INOUT	desc_len	length of the string and/or buffer for <i>desc</i> (integer)
OUT	bind	type of MPI object to which this variable must be bound (integer)
OUT	scope	scope of when changes to this variable are possible (integer)

```
int MPI_T_cvar_get_info(int cvar_index, char *name, int *name_len, int
                       *verbosity, MPI_Datatype *datatype, MPI_T_enum *enumtype, char
                       *desc, int *desc_len, int *bind, int *scope)
```

After a successful call to `MPI_T_CVAR_GET_INFO` for a particular variable, subsequent calls to this routine querying information about the same variable must return the same information. An MPI implementation is not allowed to alter any of the returned values.

The arguments *name* and *name_len* are used to return the name of the control variable as described in Section 14.3.3.

If completed successfully, the routine is required to return a name of at least length one. The name must be unique with respect to all other names for control variables used by the MPI implementation.

The argument *verbosity* returns the verbosity level of the variable (see Section 14.3.1).

1 The argument `datatype` returns the MPI datatype that is used to represent the control
2 variable.

3 If the variable is of type `MPI_INT`, MPI can optionally specify an enumeration for the
4 values represented by this variable and return it in `enumtype`. In this case, MPI returns an
5 enumeration identifier, which can then be used to gather more information as described in
6 Section 14.3.5. If the datatype is not `MPI_INT` or the argument `enumtype` is the constant
7 `MPI_T_ENUM_NULL`, no enumeration type is returned.

8 The arguments `desc` and `desc_len` are used to return a description of the control variable
9 as described in Section 14.3.3.

10 Returning a description is optional. If an MPI implementation decides not to return a
11 description, the first character for `desc` must be set to the null character and `desc_len` must
12 be set to one at the return of this call.

13 The parameter `bind` returns the type of the MPI object to which the variable must be
14 bound or the value `MPI_T_BIND_NO_OBJECT` (see Section 14.3.2).

15 The scope of a variable determines whether changing a variable's value is either local to
16 the process or must be done by the user across multiple processes. The latter is further split
17 into variables that require changes in a group of processes and those that require collective
18 changes among all connected processes. Both cases can require all processes to either be
19 set to consistent (but potentially different) values or to equal values on every participating
20 process. The description provided with the variable must contain an explanation about the
21 requirements and/or restrictions for setting the particular variable.

22 On successful return from `MPI_T_CVAR_GET_INFO`, the argument `scope` will be set to
23 one of the constants listed in Table 14.4.

Scope Constant	Description
<code>MPI_T_SCOPE_READONLY</code>	read-only, cannot be written
<code>MPI_T_SCOPE_LOCAL</code>	may be writeable, writing is a local operation
<code>MPI_T_SCOPE_GROUP</code>	may be writeable, must be done to a group of processes, all processes in a group must be set to consistent values
<code>MPI_T_SCOPE_GROUP_EQ</code>	may be writeable, must be done to a group of processes, all processes in a group must be set to the same value
<code>MPI_T_SCOPE_ALL</code>	may be writeable, must be done to all processes, all connected processes must be set to consistent values
<code>MPI_T_SCOPE_ALL_EQ</code>	may be writeable, must be done to all processes, all connected processes must be set to the same value

36
37 Table 14.4: Scopes for control variables.

38
39 *Advice to users.* The scope of a variable only indicates if a variable might be
40 changeable; it is not a guarantee that it can be changed at any time. (*End of advice*
41 *to users.*)
42

43 Example: Printing All Control Variables

44 Example 14.1

45
46 The following example shows how the MPI tool information interface can be used to
47 query and print the names of all available control variables.
48

```
#include <stdio.h> 1
#include <stdlib.h> 2
#include <mpi.h> 3
 4
int main(int argc, char **argv) { 5
    int i, err, num, namelen, bind, verbose, scope; 6
    int threadsupport; 7
    char name[100]; 8
    MPI_Datatype datatype; 9
 10
    err=MPI_T_init_thread(MPI_THREAD_SINGLE,&threadsupport); 11
    if (err!=MPI_SUCCESS) 12
        return err; 13
 14
    err=MPI_T_cvar_get_num(&num); 15
    if (err!=MPI_SUCCESS) 16
        return err; 17
 18
    for (i=0; i<num; i++) { 19
        namelen=100; 20
        err=MPI_T_cvar_get_info(i, name, &namelen, 21
                                &verbose, &datatype, MPI_T_ENUM_NULL, 22
                                NULL, NULL, /*no description */ 23
                                &bind, &scope); 24
        if (err!=MPI_SUCCESS) return err; 25
        printf("Var %i: %s\n", i, name); 26
    } 27
 28
    err=MPI_T_finalize(); 29
    if (err!=MPI_SUCCESS) 30
        return 1; 31
    else 32
        return 0; 33
} 34
 35
```

Handle Allocation and Deallocation 36

Before reading or writing the value of a variable, a user must first allocate a handle of type MPI_T_cvar_handle for the variable by binding it to an MPI object (see also Section 14.3.2). 37 38 39

Rationale. Handles used in the MPI tool information interface are distinct from handles used in the remaining parts of the MPI standard because they must be usable before MPI_INIT and after MPI_FINALIZE. Further, accessing handles, in particular for performance variables, can be time critical and having a separate handle space enables optimizations. (*End of rationale.*) 40 41 42 43 44 45

1 MPI_T_CVAR_HANDLE_ALLOC(*cvar_index*, *object*, *handle*, *count*)

2	IN	<i>cvar_index</i>	index of control variable for which handle is to be allocated (index)
3			
4			
5	IN	<i>obj_handle</i>	reference to a handle of the MPI object to which this variable is supposed to be bound (pointer)
6			
7	OUT	<i>handle</i>	allocated handle (handle)
8			
9	OUT	<i>count</i>	number of elements used to represent this variable (integer)
10			

11
12 `int MPI_T_cvar_handle_alloc(int cvar_index, void *obj_handle,`
13 `MPI_T_cvar_handle *handle, int *count)`

14 This routine binds the control variable specified by the argument *index* to an MPI
15 object. The object is passed in the argument *obj_handle* as an address to a local variable
16 that stores the object's handle. The handle allocated to reference the variable is returned
17 in the argument *handle*. Upon successful return, *count* contains the number of elements (of
18 the datatype returned by a previous MPI_T_CVAR_GET_INFO call) used to represent this
19 variable.

20
21 *Advice to users.* The *count* can be different based on the MPI object to which it
22 was bound. For example, variables bound to communicators could have a count that
23 matches the size of the communicator.

24 It is not portable to pass references to predefined MPI object handles, such as
25 MPI_COMM_WORLD to this routine, since their implementation depends on the MPI
26 library. Instead, such object handles should be stored in a local variable and the
27 address of this local variables should be passed into MPI_T_CVAR_HANDLE_ALLOC.
28 (*End of advice to users.*)

29
30 The value of *cvar_index* should be in the range 0 to $num_cvar - 1$, where *num_cvar*
31 is the number of available control variables as determined from a prior call to
32 MPI_T_CVAR_GET_NUM. The type of the MPI object it references must be consistent
33 with the type returned in the *bind* argument in a prior call to MPI_T_CVAR_GET_INFO.

34 In the case the *bind* argument returned by MPI_T_CVAR_GET_INFO equals
35 MPI_T_BIND_NO_OBJECT, the argument *obj_handle* is ignored.

36
37
38 MPI_T_CVAR_HANDLE_FREE(*handle*)

39	INOUT	<i>handle</i>	handle to be freed (handle)
40			

41
42 `int MPI_T_cvar_handle_free(MPI_T_cvar_handle *handle)`

43 When a handle is no longer needed, a user of the MPI tool information interface should
44 call MPI_T_CVAR_HANDLE_FREE to free the handle and the associated resources in the
45 MPI implementation. On a successful return, MPI sets the handle to
46 MPI_T_CVAR_HANDLE_NULL.

Control Variable Access Functions

MPI_T_CVAR_READ(handle, buf)

IN	handle	handle to the control variable to be read (handle)
OUT	buf	initial address of storage location for variable value (choice)

```
int MPI_T_cvar_read(MPI_T_cvar_handle handle, void* buf)
```

This routine queries the value of the control variable identified by the argument `handle` and stores the result in the buffer identified by the parameter `buf`. The user must ensure that the buffer is of the appropriate size to hold the entire value of the control variable (based on the returned datatype and count from prior corresponding calls to `MPI_T_CVAR_GET_INFO` and `MPI_T_CVAR_HANDLE_ALLOC`, respectively).

MPI_T_CVAR_WRITE(handle, buf)

IN	handle	handle to the control variable to be written (handle)
IN	buf	initial address of storage location for variable value (choice)

```
int MPI_T_cvar_write(MPI_T_cvar_handle handle, const void* buf)
```

This routine sets the value of the control variable identified by the argument `handle` to the data stored in the buffer identified by the parameter `buf`. The user must ensure that the buffer is of the appropriate size to hold the entire value of the control variable (based on the returned datatype and count from prior corresponding calls to `MPI_T_CVAR_GET_INFO` and `MPI_T_CVAR_HANDLE_ALLOC`, respectively).

If the variable has a global scope (as returned by a prior corresponding `MPI_T_CVAR_GET_INFO` call) any write call to this variable must be issued by the user in all connected (as defined in Section 10.5.4) MPI processes. If the variable has a group scope, any write call to this variable must be issued by the user in all MPI processes in the group, which must be described by the MPI implementation in the description by the `MPI_T_CVAR_GET_INFO`.

In both cases, the user must ensure that the writes in all processes are consistent. If the scope is either `MPI_T_SCOPE_GLOBAL_EQ` or `MPI_T_SCOPE_GROUP_EQ` this means that the variable in all processes must be set to the same value.

If it is not possible to change the variable at the time the call is made, the function returns either `MPI_T_ERR_CVAR_SETNOTNOW`, if there may be a later time at which the variable could be set, or `MPI_T_ERR_CVAR_SETNEVER`, if the variable cannot be set for the remainder of the application's execution.

Example: Reading the Value of a Control Variable

Example 14.2

1 The following example shows a routine that can be used to query the value with a
2 control variable with a given index. The example assumes that the variable is intended to
3 be bound to an MPI communicator.

```
4  
5 int getValue_int_comm(int index, MPI_Comm comm, int *val) {  
6     int err,count;  
7     MPI_T_cvar_handle handle;  
8  
9     /* This is example assumes that the variable index */  
10    /* can be bound to a communicator */  
11  
12    err=MPI_T_cvar_handle_alloc(index,&comm,&handle,&count);  
13    if (err!=MPI_SUCCESS) return err;  
14  
15    /* The following assumes that the variable is */  
16    /* represented by a single integer */  
17  
18    err=MPI_T_cvar_read(handle,val);  
19    if (err!=MPI_SUCCESS) return err;  
20  
21    err=MPI_T_cvar_handle_free(&handle);  
22    return err;  
23 }  
24
```

25 14.3.7 Performance Variables

26 The following section focuses on the ability to list and query performance variables provided
27 by the MPI implementation. Performance variables provide insight into MPI implementation
28 specific internals and can represent information such as the state of the MPI implementation
29 (e.g., waiting blocked, receiving, not active), aggregated timing data for submodules, or
30 queue sizes and lengths.

31
32 *Rationale.* The interface for performance variables is separate from the interface for
33 control variables, since performance variables have different requirements and param-
34 eters. By keeping them separate, the interface provides cleaner semantics and allows
35 for more performance optimization opportunities. (*End of rationale.*)
36

37 Performance Variable Classes

38
39 Each performance variable is associated with a class that describes its basic semantics,
40 possible datatypes, basic behavior, its starting value, whether it can overflow, and when
41 and how an MPI implementation can change the variable's value. The starting value is the
42 value the variable assumes when it is used for the first time or whenever it is reset.

43
44 *Advice to users.* If a performance variable belongs to a class that can overflow, it is
45 up to the user to appropriately protect against this, e.g., by frequently reading and
46 resetting the variable value. (*End of advice to users.*)
47
48

Advice to implementors. MPI implementations should use large enough datatypes for each performance variable to avoid overflows under normal circumstances. (*End of advice to implementors.*)

The classes are defined by the following constants:

- **MPI_T_PVAR_CLASS_STATE**

A performance variable in this class represents a set of discrete states. Variables of this class are represented by MPI_INT and can be set by the MPI implementation at any time. Variables of this type should be described further using an enumeration, as discussed in Section 14.3.5. The starting value is the current state of the implementation at the time the starting value is set. MPI implementations must ensure that variables of this class cannot overflow.

- **MPI_T_PVAR_CLASS_LEVEL**

A performance variable in this class represents a value that describes the utilization level of a resource. The value of a variable of this class can change at any time to match the current utilization level of the resource. Values returned from variables in this class are non-negative and represented by one of the following datatypes: MPI_UNSIGNED, MPI_UNSIGNED_LONG, MPI_UNSIGNED_LONG_LONG, MPI_DOUBLE. The starting value is the current utilization level of the resource at the time the starting value is set. MPI implementations must ensure that variables of this class cannot overflow.

- **MPI_T_PVAR_CLASS_SIZE**

A performance variable in this class represents a value that is the fixed size of a resource. Values returned from variables in this class are non-negative and represented by one of the following datatypes: MPI_UNSIGNED, MPI_UNSIGNED_LONG, MPI_UNSIGNED_LONG_LONG, MPI_DOUBLE. The starting value is the current utilization level of the resource at the time the starting value is set. MPI implementations must ensure that variables of this class cannot overflow.

- **MPI_T_PVAR_CLASS_PERCENTAGE**

The value of a performance variable in this class represents the percentage utilization of a finite resource. The value of a variable of this class can change at any time to match the current utilization level of the resource. It will be returned as an MPI_DOUBLE datatype. The value must always be between 0.0 (resource not used at all) and 1.0 (resource completely used). The starting value is the current percentage utilization level of the resource at the time the starting value is set. MPI implementations must ensure that variables of this class cannot overflow.

- **MPI_T_PVAR_CLASS_HIGHWATERMARK**

A performance variable in this class represents a value that describes the high watermark utilization of a resource. The value of a variable of this class is non-negative and grows monotonically from the initialization or reset of the variable. It can be represented by one of the following datatypes: MPI_UNSIGNED, MPI_UNSIGNED_LONG, MPI_UNSIGNED_LONG_LONG, MPI_DOUBLE. The starting value is the current utilization level of the resource at the time the starting value is set. MPI implementations must ensure that variables of this class cannot overflow.

- 1 • **MPI_T_PVAR_CLASS_LOWWATERMARK**
2 A performance variable in this class represents a value that describes the low wa-
3 termark utilization of a resource. The value of a variable of this class is non-
4 negative and decreases monotonically from the initialization or reset of the vari-
5 able. It can be represented by one of the following datatypes: `MPI_UNSIGNED`,
6 `MPI_UNSIGNED_LONG`, `MPI_UNSIGNED_LONG_LONG`, `MPI_DOUBLE`. The
7 starting value is the current utilization level of the resource at the time the start-
8 ing value is set. MPI implementations must ensure that variables of this class cannot
9 overflow.
- 10 • **MPI_T_PVAR_CLASS_COUNTER**
11 A performance variable in this class counts the number of occurrences of a specific
12 event (e.g., the number of memory allocations within an MPI library). The value of
13 a variable of this class increases monotonically from the initialization or reset of the
14 performance variable by one for each specific event that is observed. Values must be
15 non-negative and represented by one of the following datatypes: `MPI_UNSIGNED`,
16 `MPI_UNSIGNED_LONG`, `MPI_UNSIGNED_LONG_LONG`. The starting value for
17 variables of this class is 0. Variables of this class can overflow.
- 18 • **MPI_T_PVAR_CLASS_AGGREGATE**
19 The value of a performance variable in this class is an an aggregated value that repre-
20 sents a sum of arguments processed during a specific event (e.g., the amount of mem-
21 ory allocated by all memory allocations). This class is similar to the counter class,
22 but instead of counting individual events, the value can be incremented by arbitrary
23 amounts. The value of a variable of this class increases monotonically from the initial-
24 ization or reset of the performance variable. It must be non-negative and represented
25 by one of the following datatypes: `MPI_UNSIGNED`, `MPI_UNSIGNED_LONG`,
26 `MPI_UNSIGNED_LONG_LONG`, `MPI_DOUBLE`. The starting value for variables
27 of this class is 0. Variables of this class can overflow.
- 28 • **MPI_T_PVAR_CLASS_TIMER**
29 The value of a performance variable in this class represents the aggregated time
30 that the MPI implementation spends executing a particular event, type of event,
31 or section of the MPI library. This class has the same basic semantics as
32 **MPI_T_PVAR_CLASS_AGGREGATE**, but explicitly records a timing value. The
33 value of a variable of this class increases monotonically from the initialization
34 or reset of the performance variable. It must be non-negative and represented
35 by one of the following datatypes: `MPI_UNSIGNED`, `MPI_UNSIGNED_LONG`,
36 `MPI_UNSIGNED_LONG_LONG`, `MPI_DOUBLE`. The starting value for variables
37 of this class is 0. If the type `MPI_DOUBLE` is used, the units representing time in
38 this datatype must match the units used by `MPI_WTIME`. Otherwise, the time units
39 should be documented, e.g., in the description returned by `MPI_T_PVAR_GET_INFO`.
40 Variables of this class can overflow.
- 41 • **MPI_T_PVAR_CLASS_GENERIC**
42 This class can be used to describe a variable that does not fit into any of the other
43 classes. For variables in this class, the starting value is variable specific and imple-
44 mentation defined.
- 45
- 46
- 47
- 48

Performance Variable Query Functions

An MPI implementation exports a set of N performance variables through the MPI tool information interface. If N is zero, then the MPI implementation does not export any performance variables, otherwise the provided performance variables are indexed from 0 to $N - 1$. This index number is used in subsequent calls to identify the individual variables.

An MPI implementation is allowed to increase the number of performance variables during the execution of an MPI application when new variables become available through dynamic loading. However, MPI implementations are not allowed to change the index of a performance variable or delete a variable once it has been added to the set. When variables become inactive, e.g., through dynamic unloading, accessing its value should return a corresponding error code.

The following function can be used to query the number of performance variables, N :

`MPI_T_PVAR_GET_NUM(num_pvar)`

OUT `num_pvar` returns number of performance variables (integer)

```
int MPI_T_pvar_get_num(int *num_pvar)
```

The function `MPI_T_PVAR_GET_INFO` provides access to additional information for each variable.

```

1 MPI_T_PVAR_GET_INFO(pvar_index, name, name_len, verbosity, varclass, datatype, enum-
2     type, desc, desc_len, bind, readonly, continuous, atomic)
3
4     IN      pvar_index      index of the performance variable to be queried be-
5                          tween 0 and num_pvar - 1 (integer)
6
7     OUT     name            buffer to return the string containing the name of the
8                          performance variable (string)
9
10    INOUT   name_len       length of the string and/or buffer for name (integer)
11
12    OUT     verbosity      verbosity level of this variable (integer)
13
14    OUT     var_class      class of performance variable (integer)
15
16    OUT     datatype       MPI datatype of the information stored in the perfor-
17                          mance variable (handle)
18
19    OUT     enumtype       optional descriptor for enumeration information (han-
20                          dle)
21
22    OUT     desc           buffer to return the string containing a description of
23                          the performance variable (string)
24
25    INOUT   desc_len       length of the string and/or buffer for desc (integer)
26
27    OUT     bind           type of MPI object to which this variable must be
28                          bound (integer)
29
30    OUT     readonly      flag indicating whether the variable can be written/reset
31                          (integer)
32
33    OUT     continuous     flag indicating whether the variable can be started and
34                          stopped or is continuously active (integer)
35
36    OUT     atomic        flag indicating whether the variable can be atomically
37                          read and reset (integer)
38
39
40
41
42
43
44
45
46
47
48

```

```

30 int MPI_T_pvar_get_info(int pvar_index, char *name, int *name_len, int
31     *verbosity, int *var_class, MPI_Datatype *datatype, MPI_T_enum
32     *enumtype, char *desc, int *desc_len, int *bind, int
33     *readonly, int *continuous, int *atomic)
34

```

After a successful call to `MPI_T_PVAR_GET_INFO` for a particular variable, subsequent calls to this routine querying information about the same variable must return the same information. An MPI implementation is not allowed to alter any of the returned values.

The arguments `name` and `name_len` are used to return the name of the performance variable as described in Section 14.3.3. If completed successfully, the routine is required to return a name of at least length one.

The argument `verbosity` returns the verbosity level of the variable (see Section 14.3.1).

The class of the performance variable is returned in the parameter `var_class`. The class must be one of the constants defined in Section 14.3.7.

The combination of the name and the class of the performance variable must be unique with respect to all other names for performance variables used by the MPI implementation.

Advice to implementors. Groups of variables that belong closely together, but have different classes, can have the same name. This is, e.g., useful to refer to multiple

variables that describe a single resource (like the level, the total size, as well as high and low watermarks). *(End of advice to implementors.)*

The argument `datatype` returns the MPI datatype that is used to represent the performance variable.

If the variable is of type `MPI_INT`, MPI can optionally specify an enumeration for the values represented by this variable and return it in `enumtype`. In this case, MPI returns an enumeration identifier, which can then be used as described in Section 14.3.5 to gather more information. If the datatype is not `MPI_INT` or the argument `enumtype` is the constant `MPI_T_ENUM_NULL`, no enumeration type is returned.

Returning a description is optional. If an MPI implementation decides not to return a description, the first character for `desc` must be set to the null character and `desc_len` must be set to one at the return from this function.

The parameter `bind` returns the type of the MPI object to which the variable must be bound or the value `MPI_T_BIND_NO_OBJECT` (see Section 14.3.2).

Upon return, the argument `readonly` is set to zero if the variable can be written or reset by the user. It is set to one if the variable can only be read.

Upon return, the argument `continuous` is set to zero if the variable can be started and stopped by the user, i.e., it is possible for the user to control if and when the value of a variable is updated. It is set to one if the variable is always active and cannot be controlled by the user.

Upon return, the argument `atomic` is set to zero if the variable cannot be atomically read and reset. Only variables for which the call sets `atomic` to one, can be used in a call to `MPI_T_PVAR_READRESET`.

Performance Experiment Sessions

Within a single program, multiple components can use the MPI tool information interface. To avoid collisions with respect to accesses to performance variables, users of the MPI tool information interface must first create a session. Subsequent calls accessing performance variables can then be made within the context of this session. Any call executed in a session must not influence the results in any other session.

`MPI_T_PVAR_SESSION_CREATE(session)`

OUT `session` identifier of performance session (handle)

`int MPI_T_pvar_session_create(MPI_T_pvar_session *session)`

This call creates a new session for accessing performance variables and returns a handle for this session in the argument `session` of type `MPI_T_pvar_session`.

`MPI_T_PVAR_SESSION_FREE(session)`

INOUT `session` identifier of performance experiment session (handle)

`int MPI_T_pvar_session_free(MPI_T_pvar_session *session)`

1 This call frees an existing session. Calls to the MPI tool information interface can no
 2 longer be made within the context of a session after it is freed. On a successful return, MPI
 3 sets the session identifier to MPI_T_PVAR_SESSION_NULL.

4 Handle Allocation and Deallocation

5 Before using a performance variable, a user must first allocate a handle of type
 6 MPI_T_pvar_handle for the variable by binding it to an MPI object (see also Section 14.3.2).

7
 8
 9
 10 MPI_T_PVAR_HANDLE_ALLOC(session, pvar_index, obj_handle, handle, count)

11	IN	session	identifier of performance experiment session (handle)
12	IN	pvar_index	index of performance variable for which handle is to
13			be allocated (integer)
14	IN	obj_handle	reference to a handle of the MPI object to which this
15			variable is supposed to be bound (pointer)
16	OUT	handle	allocated handle (handle)
17	OUT	count	number of elements used to represent this variable (in-
18			teger)
19			
20			
21			

22
 23
 24
 25
 26
 27
 28
 29
 30
 31
 32
 33
 34
 35
 36
 37
 38
 39
 40
 41
 42
 43
 44
 45
 46
 47
 48

```

int MPI_T_pvar_handle_alloc(MPI_T_pvar_session session, int pvar_index,
    void *obj_handle, MPI_T_pvar_handle *handle, int *count)

```

This routine binds the performance variable specified by the argument `index` to an MPI object in the session identified by the parameter `session`. The object is passed in the argument `obj_handle` as an address to a local variable that stores the object's handle. The handle allocated to reference the variable is returned in the argument `handle`. Upon successful return, `count` contains the number of elements (of the datatype returned by a previous MPI_T_PVAR_GET_INFO call) used to represent this variable.

Advice to users. The count can be different based on the MPI object, to which is was bound. For example, variables bound to communicators could have a count that matches the size of the communicator.

It is not portable to pass references to predefined MPI object handles, such as MPI_COMM_WORLD, to this routine, since their implementation depends on the MPI library. Instead, such object handles should be stored in a local variable and the address of this local variables should be passed into MPI_T_PVAR_HANDLE_ALLOC. (*End of advice to users.*)

The value of `index` should be in the range 0 to `num_pvar - 1`, where `num_pvar` is the number of available control variables as determined from a prior call to MPI_T_PVAR_GET_NUM. The type of the MPI object it references must be consistent with the type returned in the `bind` argument in a prior call to MPI_T_PVAR_GET_INFO.

In the case the `bind` argument equals MPI_T_BIND_NO_OBJECT, the argument `obj_handle` is ignored.

`MPI_T_PVAR_HANDLE_FREE(session, handle)` 1

IN session identifier of performance experiment session (handle) 2

INOUT handle handle to be freed (handle) 3

`int MPI_T_pvar_handle_free(MPI_T_pvar_session session, MPI_T_pvar_handle *handle)` 4
5
6
7

When a handle is no longer needed, a user of the MPI tool information interface should call `MPI_T_PVAR_HANDLE_FREE` to free the handle in the session identified by the parameter `session` and the associated resources in the MPI implementation. On a successful return, MPI sets the handle to `MPI_T_PVAR_HANDLE_NULL`. 8
9
10
11
12

Starting and Stopping of Performance Variables 13

Performance variables that have the continuous flag set during the query operation are continuously operating once a handle has been allocated. Such variables may be queried at any time, but they cannot be started or stopped by the user. All other variables are in a stopped state after their handle has been allocated; their values are not updated until they have been started by the user. 14
15
16
17
18
19
20

`MPI_T_PVAR_START(session, handle)` 21
22

IN session identifier of performance experiment session (handle) 23

IN handle handle of a performance variable (handle) 24
25

`int MPI_T_pvar_start(MPI_T_pvar_session session, MPI_T_pvar_handle handle)` 26
27

This function starts the performance variable with the handle identified by the parameter `handle` in the session identified by the parameter `session`. 28
29

If the constant `MPI_T_PVAR_ALL_HANDLES` is passed in `handle`, the MPI implementation attempts to start all variables within the session identified by the parameter `session` for which handles have been allocated. In this case, the routine returns `MPI_SUCCESS` if all variables are started successfully, otherwise `MPI_T_ERR_PVAR_NOSTARTSTOP` is returned. Continuous variables and variables that are already started are ignored when `MPI_T_PVAR_ALL_HANDLES` is specified. 30
31
32
33
34
35
36

`MPI_T_PVAR_STOP(session, handle)` 37
38

IN session identifier of performance experiment session (handle) 39

IN handle handle of a performance variable (handle) 40
41

`int MPI_T_pvar_stop(MPI_T_pvar_session session, MPI_T_pvar_handle handle)` 42
43

This function stops the performance variable with the handle identified by the parameter `handle` in the session identified by the parameter `session`. 44
45

If the constant `MPI_T_PVAR_ALL_HANDLES` is passed in `handle`, the MPI implementation attempts to stop all variables within the session identified by the parameter `session` for 46
47
48

1 which handles have been allocated. In this case, the routine returns `MPI_SUCCESS` if all
 2 variables are stopped successfully, otherwise `MPI_T_ERR_PVAR_NOSTARTSTOP` is returned.
 3 Continuous variables and variables that are already stopped are ignored when
 4 `MPI_T_PVAR_ALL_HANDLES` is specified.

6 Performance Variable Access Functions

9 `MPI_T_PVAR_READ(session, handle, buf)`

11	IN	session	identifier of performance experiment session (handle)
12	IN	handle	handle of a performance variable (handle)
13	OUT	buf	initial address of storage location for variable value
14			(choice)

```
16
17 int MPI_T_pvar_read(MPI_T_pvar_session session, MPI_T_pvar_handle handle,
18                   void* buf)
```

19 The `MPI_T_PVAR_READ` call queries the value of the performance variable with the
 20 handle `handle` in the session identified by the parameter `session` and stores the result in the
 21 buffer identified by the parameter `buf`. The user is responsible to ensure that the buffer
 22 is of the appropriate size to hold the entire value of the performance variable (based on
 23 the datatype and count returned by the corresponding previous calls to
 24 `MPI_T_PVAR_GET_INFO` and `MPI_T_PVAR_HANDLE_ALLOC`, respectively).

25 The constant `MPI_T_PVAR_ALL_HANDLES` cannot be used as an argument for the func-
 26 tion `MPI_T_PVAR_READ`.

29 `MPI_T_PVAR_WRITE(session, handle, buf)`

30	IN	session	identifier of performance experiment session (handle)
31	IN	handle	handle of a performance variable (handle)
32	IN	buf	initial address of storage location for variable value
33			(choice)

```
34
35
36 int MPI_T_pvar_write(MPI_T_pvar_session session, MPI_T_pvar_handle handle,
37                    const void* buf)
```

38 The `MPI_T_PVAR_WRITE` call attempts to write the value of the performance variable
 39 with the handle identified by the parameter `handle` in the session identified by the parameter
 40 `session`. The value to be written is passed in the buffer identified by the parameter `buf`. The
 41 user must ensure that the buffer is of the appropriate size to hold the entire value of the per-
 42 formance variable (based on the datatype and count returned by the corresponding previous
 43 calls to `MPI_T_PVAR_GET_INFO` and `MPI_T_PVAR_HANDLE_ALLOC`, respectively).

44 If it is not possible to change the variable, the function returns
 45 `MPI_T_ERR_PVAR_NOWRITE`.

46 The constant `MPI_T_PVAR_ALL_HANDLES` cannot be used as an argument for the func-
 47 tion `MPI_T_PVAR_WRITE`.

`MPI_T_PVAR_RESET(session, handle)`

IN	<code>session</code>	identifier of performance experiment session (handle)
IN	<code>handle</code>	handle of a performance variable (handle)

`int MPI_T_pvar_reset(MPI_T_pvar_session session, MPI_T_pvar_handle handle)`

The `MPI_T_PVAR_RESET` call sets the performance variable with the handle identified by the parameter `handle` to its starting value specified in Section 14.3.7. If it is not possible to change the variable, the function returns `MPI_T_ERR_PVAR_NOWRITE`.

If the constant `MPI_T_PVAR_ALL_HANDLES` is passed in `handle`, the MPI implementation attempts to reset all variables within the session identified by the parameter `session` for which handles have been allocated. In this case, the routine returns `MPI_SUCCESS` if all variables are reset successfully, otherwise `MPI_T_ERR_PVAR_NOWRITE` is returned. Read-only variables are ignored when `MPI_T_PVAR_ALL_HANDLES` is specified.

`MPI_T_PVAR_READRESET(session, handle, buf)`

IN	<code>session</code>	identifier of performance experiment session (handle)
IN	<code>handle</code>	handle of a performance variable (handle)
OUT	<code>buf</code>	initial address of storage location for variable value (choice)

`int MPI_T_pvar_readreset(MPI_T_pvar_session session, MPI_T_pvar_handle handle, void* buf)`

This call atomically combines the functionality of `MPI_T_PVAR_READ` and `MPI_T_PVAR_RESET` with the same semantics as if these two calls were called separately. If atomic operations on this variable are not supported, this routine returns `MPI_ERR_NOATOMIC`.

The constant `MPI_T_PVAR_ALL_HANDLES` can not be used as an argument for the function `MPI_T_PVAR_READRESET`.

Advice to implementors. Sampling based tools rely on the ability to call the MPI tool information interface, in particular routines to start, stop, read, write and reset performance variables, from any program context, including asynchronous contexts such as signal handlers. MPI implementations should strive, if possible in their particular environment, to enable these usage scenarios for all or a subset of the routines mentioned above. If implementing only a subset, the read, write, and reset routines are typically the most critical for sampling based tools. An MPI implementation should clearly document any restrictions on the program contexts in which the MPI tool information interface can be used. Restrictions might include guaranteeing usage outside of all signals or outside a specific set of signals. Any restrictions could be documented, for example, through the description returned by `MPI_T_PVAR_GET_INFO`. (*End of advice to implementors.*)

Rationale. All routines to read, write or reset performance variables require the session argument. This keeps the interface consistent and allows the use

1 MPI_T_PVAR_ALL_HANDLES where appropriate. Further, this opens up additional
 2 performance optimizations for the implementation of handles. (*End of rationale.*)
 3

4 Example: Tool to Detect Receives with Long Unexpected Message Queues
 5

6 Example 14.3

7 The following example shows a sample tool to identify receive operations that occur
 8 during times with long message queues. This examples assumes that the MPI implementa-
 9 tion exports a variable with the name "MPI_T_UMQ_LENGTH" to represent the current length
 10 of the unexpected message queue. The tool is implemented as a PMPI tool using the MPI
 11 profiling interface.
 12

13 The tool consists of three parts: (1) the initialization (by intercepting the call to
 14 MPI_INIT), (2) the test for long unexpected message queues (by intercepting calls to
 15 MPI_RECV), and (3) the clean up phase (by intercepting the call to MPI_FINALIZE. To
 16 capture all receives, the example would have to be extended to have similar wrappers for
 17 all receive operations.
 18

19 Part 1— Initialization: During initialization, the tool searches for the variable and, once
 20 the right index is found, allocates a session and a handle for the variable with the found
 21 index, and starts the performance variable.
 22

```

23 #include <stdio.h>
24 #include <stdlib.h>
25 #include <assert.h>
26 #include <mpi.h>
27
28 /* Global variables for the tool */
29 static MPI_T_pvar_session session;
30 static MPI_T_pvar_handle handle;
31
32 int MPI_Init(int *argc, char ***argv) {
33     int err, num, i, index, namelen, verbosity;
34     int var_class, bind, threadsup;
35     int readonly, continuous, atomic, count;
36     char name[17];
37     MPI_Comm comm;
38     MPI_Datatype datatype;
39     MPI_T_enum enumtype;
40
41     err=PMPI_Init(argc,argv);
42     if (err!=MPI_SUCCESS) return err;
43
44     err=PMPI_T_init_thread(MPI_THREAD_SINGLE,&threadsup);
45     if (err!=MPI_SUCCESS) return err;
46
47     err=PMPI_T_pvar_get_num(&num);
48     if (err!=MPI_SUCCESS) return err;

```

```

index=-1;
i=0;
while ((i<num) && (index<0)) {
    namelen=17;
    err=PMPI_T_pvar_get_info(i, name, namelen, &verbosity,
        &var_class, &datatype, &enumtype, &bind,
        &readonly, &continuous, &atomic);
    if (strcmp(name,"MPI_T_UMQ_LENGTH")==0) index=i;
    i++; }

/* this could be handled in a more flexible way for a generic tool */
assert(index>=0);
assert(var_class==MPI_T_PVAR_CLASS_LEVEL);
assert(datatype==MPI_INT);
assert(bind==MPI_T_BIND_MPI_COMM);

/* Create a session */
err=PMPI_T_pvar_session_create(&session);
if (err!=MPI_SUCCESS) return err;

/* Get a handle and bind to MPI_COMM_WORLD */
comm=MPI_COMM_WORLD;
err=PMPI_T_pvar_handle_alloc(session, index, &comm, &handle, &count);
if (err!=MPI_SUCCESS) return err;

/* this could be handled in a more flexible way for a generic tool */
assert(count==1);

/* Start variable */
err=PMPI_T_pvar_start(session, handle);
if (err!=MPI_SUCCESS) return err;

return MPI_SUCCESS;
}

```

Part 2 — Testing the Queue Lengths During Receives: During every receive operation, the tool reads the unexpected queue length through the matching performance variable and compares it against a predefined threshold.

```

#define THRESHOLD 5

int MPI_Recv(void *buf, int count, MPI_Datatype datatype, int source, int tag,
             MPI_Comm comm, MPI_Status *status)
{
    int value, err;

    if (comm==MPI_COMM_WORLD) {
        err=PMPI_T_pvar_read(session, handle, &value);

```

```

1         if ((err==MPI_SUCCESS) && (value>THRESHOLD))
2         {
3             /* tool identified receive called with long UMQ */
4             /* execute tool functionality, */
5             /* e.g., gather and print call stack */
6         }
7     }
8
9     return PMPI_Recv(buf, count, datatype, source, tag, comm, status);
10 }
11

```

Part 3 — Termination: In the wrapper for `MPI_FINALIZE`, the MPI tool information interface is finalized.

```

15 int MPI_Finalize()
16 {
17     int err;
18     err=PMPI_T_handle_free(&session, &handle);
19     err=PMPI_T_session_free(&session);
20     err=PMPI_T_finalize();
21     return PMPI_Finalize();
22 }
23

```

14.3.8 Variable Categorization

MPI implementations can optionally group performance and control variables into categories to express logical relationships between various variables. For example, an MPI implementation could group all control and performance variables that refer to message transfers in the MPI implementation and thereby distinguish them from variables that refer to local resources such as memory allocations or other interactions with the operating system.

Categories can also contain other categories to form a hierarchical grouping. Categories can never include themselves, either directly or transitively within other included categories. Expanding on the example above, this allows MPI to refine the grouping of variables referring to message transfers into variables to control and monitor message queues, message matching activities and communication protocols. Each of these groups of variables would be represented by a separate category and these categories would then be listed in a single category representing variables for message transfers.

The category information may be queried in a fashion similar to the mechanism for querying variable information. The MPI implementation exports a set of N categories via the MPI tool information interface. If $N = 0$, then the MPI implementation does not export any categories, otherwise the provided categories are indexed from 0 to $N - 1$. This index number is used in subsequent calls to functions of the MPI tool information interface to identify the individual categories.

An MPI implementation is permitted to increase the number of categories during the execution of an MPI program when new categories become available through dynamic loading. However, MPI implementations are not allowed to change the index of a category or delete it once it has been added to the set.

Similarly, MPI implementations are allowed to add variables to categories, but they are not allowed to remove variables from categories or change the order in which they are returned.

The following function can be used to query the number of control variables, N .

```
MPI_T_CATEGORY_GET_NUM(num_cat)
```

```
OUT    num_cat          current number of categories (integer)
```

```
int MPI_T_category_get_num(int *num_cat)
```

Individual category information can then be queried by calling the following function:

```
MPI_T_CATEGORY_GET_INFO(cat_index, name, name_len, desc, desc_len, num_cvars, num_pvars,
                        num_categories)
```

```
IN     cat_index       index of the category to be queried (integer)
```

```
OUT    name            buffer to return the string containing the name of the
                        category (string)
```

```
INOUT  name_len       length of the string and/or buffer for name (integer)
```

```
OUT    desc            buffer to return the string containing the description
                        of the category (string)
```

```
INOUT  desc_len       length of the string and/or buffer for desc (integer)
```

```
OUT    num_cvars       number of control variables in the category (integer)
```

```
OUT    num_pvars       number of performance variables in the category (in-
                        teger)
```

```
OUT    num_categories  number of categories contained in the category (inte-
                        ger)
```

```
int MPI_T_category_get_info(int cat_index, char *name, int *name_len, char
                            *desc, int *desc_len, int *num_cvars, int *num_pvars, int
                            *num_categories)
```

The arguments `name` and `name_len` are used to return the name of the category as described in Section 14.3.3.

The routine is required to return a name of at least length one. This name must be unique with respect to all other names for categories used by the MPI implementation.

The arguments `desc` and `desc_len` are used to return the description of the category as described in Section 14.3.3.

Returning a description is optional. If an MPI implementation decides not to return a description, the first character for `desc` must be set to the null character and `desc_len` must be set to one at the return of this call.

The function returns the number of control variables, performance variables and other categories contained in the queried category in the arguments `num_cvars`, `num_pvars`, and `num_categories`, respectively.

1 `MPI_T_CATEGORY_GET_CVARS(cat_index, len, indices)`

2 IN `cat_index` index of the category to be queried, in the range $[0, N-1]$ (integer)
 3
 4
 5 IN `len` the length of the indices array (integer)
 6 OUT `indices` an integer array of size `len`, indicating control variable
 7 indices (array of integers)
 8

9 `int MPI_T_category_get_cvars(int cat_index, int len, int indices[])`

10
 11 `MPI_T_CATEGORY_GET_CVARS` can be used to query which control variables are
 12 contained in a particular category. A category contains zero or more control variables.
 13

14 `MPI_T_CATEGORY_GET_PVARS(cat_index,len,indices)`

15
 16 IN `cat_index` index of the category to be queried, in the range $[0, N-1]$ (integer)
 17
 18 IN `len` the length of the indices array (integer)
 19 OUT `indices` an integer array of size `len`, indicating performance
 20 variable indices (array of integers)
 21

22
 23 `int MPI_T_category_get_pvars(int cat_index, int len, int indices[])`

24
 25 `MPI_T_CATEGORY_GET_PVARS` can be used to query which performance variables
 26 are contained in a particular category. A category contains zero or more performance
 27 variables.
 28

29 `MPI_T_CATEGORY_GET_CATEGORIES(cat_index,len,indices)`

30 IN `cat_index` index of the category to be queried, in the range $[0, N-1]$ (integer)
 31
 32 IN `len` the length of the indices array (integer)
 33 OUT `indices` an integer array of size `len`, indicating category indices
 34 (array of integers)
 35
 36

37 `int MPI_T_category_get_categories(int cat_index, int len, int indices[])`

38
 39 `MPI_T_CATEGORY_GET_CATEGORIES` can be used to query which other categories
 40 are contained in a particular category. A category contains zero or more other categories.

41 As mentioned above, MPI implementations can grow the number of categories as well
 42 as the number of variables or other categories within a category. In order to allow users
 43 of the MPI tool information interface to quickly check whether new categories have been
 44 added or new variables or categories have been added to a category, MPI maintains a
 45 virtual timestamp. This timestamp is monotonically increasing during the execution and is
 46 returned by the following function:
 47
 48

`MPI_T_CATEGORY_CHANGED(stamp)`

OUT `stamp` a virtual time stamp to indicate the last change to the categories (integer)

`int MPI_T_category_changed(int *stamp)`

If two subsequent calls to this routine return the same timestamp, it is guaranteed that the category information has not changed between the two calls. If the timestamp retrieved from the second call is higher, then some categories have been added or expanded.

Advice to users. The timestamp value is purely virtual and only intended to check for changes in the category information. It should not be used for any other purpose. (*End of advice to users.*)

The index values returned in indices by `MPI_T_CATEGORY_GET_CVARS`, `MPI_T_CATEGORY_GET_PVARS` and `MPI_T_CATEGORY_GET_CATEGORIES` can be used as input to `MPI_T_CVAR_GET_INFO`, `MPI_T_PVAR_GET_INFO` and `MPI_T_CATEGORY_GET_INFO`, respectively.

The user is responsible for allocating the arrays passed into the functions `MPI_T_CATEGORY_GET_CVARS`, `MPI_T_CATEGORY_GET_PVARS` and `MPI_T_CATEGORY_GET_CATEGORIES`. Starting from array index 0, each function writes up to `len` elements into the array. If the category contains more than `len` elements, the function returns an arbitrary subset of size `len`. Otherwise, the entire set of elements is returned in the beginning entries of the array, and any remaining array entries are not modified.

14.3.9 Return Codes for the MPI tool information interface

All functions defined as part of the MPI tool information interface return an integer return code (see Table 14.5) to indicate whether the function has completed successfully or aborted its execution. In the latter case the return code indicates the reason for not completing the routine. None of the return codes returned by an routine impact the execution of the MPI process and do not invoke MPI error handlers. The execution of the MPI process continues as if the call would have completed. However, the MPI implementation is not required to check all user provided parameters; if a user passes invalid parameter values to any routine the behavior of the implementation is undefined.

All return codes with the prefix `MPI_T_` must be unique values and cannot overlap with any other return values returned by the MPI implementation.

14.3.10 Profiling Interface

All requirements for the profiling interfaces, as described in Section 14.2, also apply to the MPI tool information interface. All rules, guidelines, and recommendations from Section 14.2 apply equally to calls defined as part of the MPI tool information interface.

Return Code	Description
Return Codes for all Functions in the MPI tool information interface	
MPI_SUCCESS	Call completed successfully
MPI_T_ERR_MEMORY	Out of memory
MPI_T_ERR_NOTINITIALIZED	Interface not initialized
MPI_T_ERR_CANTINIT	Interface not in the state to be initialized
Return Codes for Datatype Functions: MPI_T_ENUM_*	
MPI_T_ERR_INVALIDINDEX	The enumeration index is invalid or has been deleted.
MPI_T_ERR_INVALIDITEM	The item index queried is out of range (for MPI_T_ENUMITEM only)
Return Codes for variable and category query functions: MPI_T_*_GET_INFO	
MPI_T_ERR_INVALIDINDEX	The variable or category index is invalid
Return Codes for Handle Functions: MPI_T_*_ALLOCATE,FREE	
MPI_T_ERR_INVALIDINDEX	The variable index is invalid or has been deleted
MPI_T_ERR_INVALIDHANDLE	The handle is invalid
MPI_T_ERR_OUTOFHANDLES	No more handles available
Return Codes for Session Functions: MPI_T_PVAR_SESSION_*	
MPI_T_ERR_OUTOFSESSIONS	No more sessions available
MPI_T_ERR_INVALIDSESSION	Session argument is not a valid session
Return Codes for Control Variable Access Functions: MPI_T_CVAR_READ, WRITE	
MPI_T_ERR_CVAR_SETNOTNOW	Variable cannot be set at this moment
MPI_T_ERR_CVAR_SETNEVER	Variable cannot be set until end of execution
MPI_T_ERR_INVALIDHANDLE	The handle is invalid
Return Codes for Performance Variable Access and Control: MPI_T_PVAR_START, STOP, READ, WRITE, RESET, READRESET	
MPI_T_ERR_INVALIDHANDLE	The handle is invalid
MPI_T_ERR_INVALIDSESSION	Session argument is not a valid session
MPI_T_ERR_PVAR_NOSTARTSTOP	Variable can not be started or stopped (for MPI_T_PVAR_START and MPI_T_PVAR_STOP)
MPI_T_ERR_PVAR_NOWRITE	Variable can not be written or reset (for MPI_T_PVAR_WRITE and MPI_T_PVAR_RESET)
MPI_T_NOATOMIC	Variable cannot be read and written atomically (for MPI_T_PVAR_READRESET)
Return Codes for Category Functions: MPI_T_CATEGORY_*	
MPI_T_ERR_INVALIDINDEX	The category index is invalid

Table 14.5: Return codes used in functions of the MPI tool information interface.

Chapter 15

Deprecated Functions

15.1 Deprecated since MPI-2.0

The following function is deprecated and is superseded by `MPI_TYPE_CREATE_HVECTOR` in MPI-2.0. The language independent definition and the C binding of the deprecated function is the same as of the new function, except of the function name. Only the Fortran language binding is different.

`MPI_TYPE_HVECTOR(count, blocklength, stride, oldtype, newtype)`

IN	count	number of blocks (non-negative integer)
IN	blocklength	number of elements in each block (non-negative integer)
IN	stride	number of bytes between start of each block (integer)
IN	oldtype	old datatype (handle)
OUT	newtype	new datatype (handle)

```
int MPI_Type_hvector(int count, int blocklength, MPI_Aint stride,  
                    MPI_Datatype oldtype, MPI_Datatype *newtype)
```

For this routine, an interface within the `mpi_f08` module was never defined.

```
MPI_TYPE_HVECTOR(COUNT, BLOCKLENGTH, STRIDE, OLDTYPE, NEWTYPE, IERROR)  
INTEGER COUNT, BLOCKLENGTH, STRIDE, OLDTYPE, NEWTYPE, IERROR
```

The following function is deprecated and is superseded by `MPI_TYPE_CREATE_HINDEXED` in MPI-2.0. The language independent definition and the C binding of the deprecated function is the same as of the new function, except of the function name. Only the Fortran language binding is different.

```

1 MPI_TYPE_HINDEXED( count, array_of_blocklengths, array_of_displacements, oldtype, new-
2     type)
3     IN     count           number of blocks – also number of entries in
4     array_of_displacements and array_of_blocklengths (non-
5     negative integer)
6
7     IN     array_of_blocklengths  number of elements in each block (array of non-negative
8     integers)
9
10    IN     array_of_displacements  byte displacement of each block (array of integer)
11
12    IN     oldtype                old datatype (handle)
13
14    OUT    newtype                new datatype (handle)

```

```

14 int MPI_Type_hindexed(int count, int *array_of_blocklengths,
15     MPI_Aint *array_of_displacements, MPI_Datatype oldtype,
16     MPI_Datatype *newtype)

```

ticket229.1. For this routine, an interface within the `mpi_f08` module was never defined.

```

19 MPI_TYPE_HINDEXED(COUNT, ARRAY_OF_BLOCKLENGTHS, ARRAY_OF_DISPLACEMENTS,
20     OLDTYPE, NEWTYPE, IERROR)
21     INTEGER COUNT, ARRAY_OF_BLOCKLENGTHS(*), ARRAY_OF_DISPLACEMENTS(*),
22     OLDTYPE, NEWTYPE, IERROR

```

The following function is deprecated and is superseded by `MPI_TYPE_CREATE_STRUCT` in MPI-2.0. The language independent definition and the C binding of the deprecated function is the same as of the new function, except of the function name. Only the Fortran language binding is different.

```

29 MPI_TYPE_STRUCT(count, array_of_blocklengths, array_of_displacements, array_of_types,
30     newtype)
31
32    IN     count           number of blocks (integer) (non-negative integer) –
33    also number of entries in arrays array_of_types,
34    array_of_displacements and array_of_blocklengths
35
36    IN     array_of_blocklength  number of elements in each block (array of non-negative
37    integer)
38
39    IN     array_of_displacements  byte displacement of each block (array of integer)
40
41    IN     array_of_types        type of elements in each block (array of handles to
42    datatype objects)
43
44    OUT    newtype                new datatype (handle)

```

```

43 int MPI_Type_struct(int count, int *array_of_blocklengths,
44     MPI_Aint *array_of_displacements,
45     MPI_Datatype *array_of_types, MPI_Datatype *newtype)

```

ticket229.1. For this routine, an interface within the `mpi_f08` module was never defined.

```

MPI_TYPE_STRUCT(COUNT, ARRAY_OF_BLOCKLENGTHS, ARRAY_OF_DISPLACEMENTS,
                ARRAY_OF_TYPES, NEWTYPE, IERROR)
    INTEGER COUNT, ARRAY_OF_BLOCKLENGTHS(*), ARRAY_OF_DISPLACEMENTS(*),
    ARRAY_OF_TYPES(*), NEWTYPE, IERROR

```

The following function is deprecated and is superseded by `MPI_GET_ADDRESS` in MPI-2.0. The language independent definition and the C binding of the deprecated function is the same as of the new function, except of the function name. Only the Fortran language binding is different.

```

MPI_ADDRESS(location, address)

```

IN	location	location in caller memory (choice)
OUT	address	address of location (integer)

```

int MPI_Address(void* location, MPI_Aint *address)

```

For this routine, an interface within the `mpi_f08` module was never defined.

```

MPI_ADDRESS(LOCATION, ADDRESS, IERROR)
    <type> LOCATION(*)
    INTEGER ADDRESS, IERROR

```

The following functions are deprecated and are superseded by `MPI_TYPE_GET_EXTENT` in MPI-2.0.

```

MPI_TYPE_EXTENT(datatype, extent)

```

IN	datatype	datatype (handle)
OUT	extent	datatype extent (integer)

```

int MPI_Type_extent(MPI_Datatype datatype, MPI_Aint *extent)

```

For this routine, an interface within the `mpi_f08` module was never defined.

```

MPI_TYPE_EXTENT(DATATYPE, EXTENT, IERROR)
    INTEGER DATATYPE, EXTENT, IERROR

```

Returns the extent of a datatype, where extent is as defined on page 113.

The two functions below can be used for finding the lower bound and the upper bound of a datatype.

```

MPI_TYPE_LB( datatype, displacement)

```

IN	datatype	datatype (handle)
OUT	displacement	displacement of lower bound from origin, in bytes (integer)

```

int MPI_Type_lb(MPI_Datatype datatype, MPI_Aint* displacement)

```

ticket229.1.

For this routine, an interface within the `mpi_f08` module was never defined.

```
MPI_TYPE_LB( DATATYPE, DISPLACEMENT, IERROR)
    INTEGER DATATYPE, DISPLACEMENT, IERROR
```

```
MPI_TYPE_UB( datatype, displacement)
```

```
    IN      datatype          datatype (handle)
    OUT     displacement      displacement of upper bound from origin, in bytes (integer)
```

```
int MPI_Type_ub(MPI_Datatype datatype, MPI_Aint* displacement)
```

For this routine, an interface within the `mpi_f08` module was never defined.

```
MPI_TYPE_UB( DATATYPE, DISPLACEMENT, IERROR)
    INTEGER DATATYPE, DISPLACEMENT, IERROR
```

The following function is deprecated and is superseded by `MPI_COMM_CREATE_KEYVAL` in MPI-2.0. The language independent definition of the deprecated function is the same as that of the new function, except for the function name and a different behavior in the C/Fortran language interoperability, see Section 16.3.7 on page 706. The language bindings are modified.

```
MPI_KEYVAL_CREATE(copy_fn, delete_fn, keyval, extra_state)
```

```
    IN      copy_fn          Copy callback function for keyval
    IN      delete_fn       Delete callback function for keyval
    OUT     keyval          key value for future access (integer)
    IN      extra_state     Extra state for callback functions
```

```
int MPI_Keyval_create(MPI_Copy_function *copy_fn, MPI_Delete_function
    *delete_fn, int *keyval, void* extra_state)
```

For this routine, an interface within the `mpi_f08` module was never defined.

```
MPI_KEYVAL_CREATE(COPY_FN, DELETE_FN, KEYVAL, EXTRA_STATE, IERROR)
    EXTERNAL COPY_FN, DELETE_FN
    INTEGER KEYVAL, EXTRA_STATE, IERROR
```

The `copy_fn` function is invoked when a communicator is duplicated by `MPI_COMM_DUP`. `copy_fn` should be of type `MPI_Copy_function`, which is defined as follows:

```
typedef int MPI_Copy_function(MPI_Comm oldcomm, int keyval,
    void *extra_state, void *attribute_val_in,
    void *attribute_val_out, int *flag)
```

ticket229.1.

A Fortran declaration for such a function is as follows:

For this routine, an interface within the `mpi_f08` module was never defined.

```

SUBROUTINE COPY_FUNCTION(OLDCOMM, KEYVAL, EXTRA_STATE, ATTRIBUTE_VAL_IN,
    ATTRIBUTE_VAL_OUT, FLAG, IERR)
    INTEGER OLDCOMM, KEYVAL, EXTRA_STATE, ATTRIBUTE_VAL_IN,
    ATTRIBUTE_VAL_OUT, IERR
    LOGICAL FLAG

```

`copy_fn` may be specified as `MPI_NULL_COPY_FN` or `MPI_DUP_FN` from either C or FORTRAN; `MPI_NULL_COPY_FN` is a function that does nothing other than returning `flag = 0` and `MPI_SUCCESS`. `MPI_DUP_FN` is a simple-minded copy function that sets `flag = 1`, returns the value of `attribute_val_in` in `attribute_val_out`, and returns `MPI_SUCCESS`. Note that `MPI_NULL_COPY_FN` and `MPI_DUP_FN` are also deprecated.

Analogous to `copy_fn` is a callback deletion function, defined as follows. The `delete_fn` function is invoked when a communicator is deleted by `MPI_COMM_FREE` or when a call is made explicitly to `MPI_ATTR_DELETE`. `delete_fn` should be of type `MPI_Delete_function`, which is defined as follows:

```

typedef int MPI_Delete_function(MPI_Comm comm, int keyval,
    void *attribute_val, void *extra_state);

```

A Fortran declaration for such a function is as follows:

For this routine, an interface within the `mpi_f08` module was never defined.

```

SUBROUTINE DELETE_FUNCTION(COMM, KEYVAL, ATTRIBUTE_VAL, EXTRA_STATE, IERR)
    INTEGER COMM, KEYVAL, ATTRIBUTE_VAL, EXTRA_STATE, IERR

```

`delete_fn` may be specified as `MPI_NULL_DELETE_FN` from either C or FORTRAN; `MPI_NULL_DELETE_FN` is a function that does nothing, other than returning `MPI_SUCCESS`. Note that `MPI_NULL_DELETE_FN` is also deprecated.

The following function is deprecated and is superseded by `MPI_COMM_FREE_KEYVAL` in MPI-2.0. The language independent definition of the deprecated function is the same as of the new function, except of the function name. The language bindings are modified.

```

MPI_KEYVAL_FREE(keyval)

```

INOUT keyval Frees the integer key value (integer)

```

int MPI_Keyval_free(int *keyval)

```

For this routine, an interface within the `mpi_f08` module was never defined.

```

MPI_KEYVAL_FREE(KEYVAL, IERROR)
    INTEGER KEYVAL, IERROR

```

The following function is deprecated and is superseded by `MPI_COMM_SET_ATTR` in MPI-2.0. The language independent definition of the deprecated function is the same as of the new function, except of the function name. The language bindings are modified.

1 MPI_ATTR_PUT(comm, keyval, attribute_val)

2 INOUT comm communicator to which attribute will be attached (handle)

3
4 IN keyval key value, as returned by
5 MPI_KEYVAL_CREATE (integer)

6
7 IN attribute_val attribute value

8
9 int MPI_Attr_put(MPI_Comm comm, int keyval, void* attribute_val)

10 ticket229.1. **For this routine, an interface within the mpi_f08 module was never defined.**

11
12 MPI_ATTR_PUT(COMM, KEYVAL, ATTRIBUTE_VAL, IERROR)

13 INTEGER COMM, KEYVAL, ATTRIBUTE_VAL, IERROR

14
15 The following function is deprecated and is superseded by MPI_COMM_GET_ATTR in
16 MPI-2.0. The language independent definition of the deprecated function is the same as of
17 the new function, except of the function name. The language bindings are modified.

18
19
20 MPI_ATTR_GET(comm, keyval, attribute_val, flag)

21 IN comm communicator to which attribute is attached (handle)

22 IN keyval key value (integer)

23 OUT attribute_val attribute value, unless flag = false

24 OUT flag true if an attribute value was extracted; false if no
25 attribute is associated with the key

26
27
28 int MPI_Attr_get(MPI_Comm comm, int keyval, void *attribute_val, int *flag)

29 ticket229.1. **For this routine, an interface within the mpi_f08 module was never defined.**

30
31 MPI_ATTR_GET(COMM, KEYVAL, ATTRIBUTE_VAL, FLAG, IERROR)

32 INTEGER COMM, KEYVAL, ATTRIBUTE_VAL, IERROR

33 LOGICAL FLAG

34
35 The following function is deprecated and is superseded by MPI_COMM_DELETE_ATTR
36 in MPI-2.0. The language independent definition of the deprecated function is the same as
37 of the new function, except of the function name. The language bindings are modified.

38
39 MPI_ATTR_DELETE(comm, keyval)

40 INOUT comm communicator to which attribute is attached (handle)

41 IN keyval The key value of the deleted attribute (integer)

42
43
44 int MPI_Attr_delete(MPI_Comm comm, int keyval)

45 ticket229.1. **For this routine, an interface within the mpi_f08 module was never defined.**

46
47 MPI_ATTR_DELETE(COMM, KEYVAL, IERROR)

INTEGER COMM, KEYVAL, IERROR

The following function is deprecated and is superseded by MPI_COMM_CREATE_ERRHANDLER in MPI-2.0. The language independent definition of the deprecated function is the same as of the new function, except of the function name. The language bindings are modified.

MPI_ERRHANDLER_CREATE([function]handler_fn, errhandler)

IN [ticket252-W.] [function]handler_fn user defined error handling procedure
 OUT errhandler MPI error handler (handle)

```
int MPI_Errhandler_create(MPI_Handler_function * [function]handler_fn,
                        MPI_Errhandler *errhandler)
```

For this routine, an interface within the mpi_f08 module was never defined.

```
MPI_ERRHANDLER_CREATE( [FUNCTION]HANDLER_FN, ERRHANDLER, IERROR)
EXTERNAL [FUNCTION]HANDLER_FN
INTEGER ERRHANDLER, IERROR
```

Register the user routine [function]handler_fn for use as an MPI exception handler. Returns in errhandler a handle to the registered exception handler.

In the C language, the user routine should be a C function of type MPI_Handler_function, which is defined as:

```
typedef void (MPI_Handler_function)(MPI_Comm *, int *, ...);
```

The first argument is the communicator in use, the second is the error code to be returned.

In the Fortran language, the user routine should be of the form:

```
SUBROUTINE HANDLER_FUNCTION(COMM, ERROR_CODE)
  INTEGER COMM, ERROR_CODE
```

The following function is deprecated and is superseded by MPI_COMM_SET_ERRHANDLER in MPI-2.0. The language independent definition of the deprecated function is the same as of the new function, except of the function name. The language bindings are modified.

MPI_ERRHANDLER_SET(comm, errhandler)

INOUT comm communicator to set the error handler for (handle)
 IN errhandler new MPI error handler for communicator (handle)

```
int MPI_Errhandler_set(MPI_Comm comm, MPI_Errhandler errhandler)
```

For this routine, an interface within the mpi_f08 module was never defined.

```
MPI_ERRHANDLER_SET(COMM, ERRHANDLER, IERROR)
```

1 INTEGER COMM, ERRHANDLER, IERROR

2
3 Associates the new error handler `errorhandler` with communicator `comm` at the calling
4 process. Note that an error handler is always associated with the communicator.

5 The following function is deprecated and is superseded by
6 `MPI_COMM_GET_ERRHANDLER` in MPI-2.0. The language independent definition of the
7 deprecated function is the same as of the new function, except of the function name. The
8 language bindings are modified.

9
10 MPI_ERRHANDLER_GET(`comm`, `errhandler`)

11 IN `comm` communicator to get the error handler from (handle)
12
13 OUT `errhandler` MPI error handler currently associated with commu-
14 nicator (handle)

15
16 int MPI_Errhandler_get(MPI_Comm `comm`, MPI_Errhandler *`errhandler`)

17 For this routine, an interface within the `mpi_f08` module was never defined.

18
19 MPI_ERRHANDLER_GET(COMM, ERRHANDLER, IERROR)

20 INTEGER COMM, ERRHANDLER, IERROR

21
22 Returns in `errhandler` (a handle to) the error handler that is currently associated with
23 communicator `comm`.

24 25 15.2 Deprecated since MPI-2.2

26
27 The entire set of C++ language bindings have been deprecated.

28
29 *Rationale.* The C++ bindings add minimal functionality over the C bindings while
30 incurring a significant amount of maintenance to the MPI specification. Since the
31 C++ bindings are effectively a one-to-one mapping of the C bindings, it should be
32 relatively easy to convert existing C++ MPI applications to use the MPI C bindings.
33 Additionally, there are third party packages available that provide C++ class library
34 functionality (i.e., C++-specific functionality layered on top of the MPI C bindings)
35 that are likely more expressive and/or natural to C++ programmers and are not
36 suitable for standardization in this specification. (*End of rationale.*)

37
38 The following function typedefs have been deprecated and are superseded by new
39 names. Other than the typedef names, the function signatures are exactly the same; the
40 names were updated to match conventions of other function typedef names.

Deprecated Name	New Name
<code>MPI_Comm_errhandler_fn</code>	<code>MPI_Comm_errhandler_function</code>
<code>MPI::Comm::Errhandler_fn</code>	<code>MPI::Comm::Errhandler_function</code>
<code>MPI_File_errhandler_fn</code>	<code>MPI_File_errhandler_function</code>
<code>MPI::File::Errhandler_fn</code>	<code>MPI::File::Errhandler_function</code>
<code>MPI_Win_errhandler_fn</code>	<code>MPI_Win_errhandler_function</code>
<code>MPI::Win::Errhandler_fn</code>	<code>MPI::Win::Errhandler_function</code>

15.3 Deprecated since MPI-3.0

□

1
2 ticket245-Q.
3 ticket229.1.
4
5
6
7
8
9
10
11
12
13
14
15
16
17
18
19
20
21
22
23
24
25
26
27
28
29
30
31
32
33
34
35
36
37
38
39
40
41
42
43
44
45
46
47
48

1
2
3
4
5
6
7
8
9
10
11
12
13
14
15
16
17
18
19
20
21
22
23
24
25
26
27
28
29
30
31
32
33
34
35
36
37
38
39
40
41
42
43
44
45
46
47
48

1
2
3
4
5
6
7
8
9
10
11
12
13
14
15
16
17
18
19
20
21
22
23
24
25
26
27
28
29
30
31
32
33
34
35
36
37
38
39
40
41
42
43
44
45
46
47
48

Chapter 16

Language Bindings

16.1 C++

16.1.1 Overview

The C++ language bindings have been deprecated. **A compliant MPI implementation providing C++ language bindings must provide the entire set defined in this document.** [ticket279](#).

There are some issues specific to C++ that must be considered in the design of an interface that go beyond the simple description of language bindings. In particular, in C++, we must be concerned with the design of objects and their interfaces, rather than just the design of a language-specific functional interface to MPI. Fortunately, the design of MPI was based on the notion of objects, so a natural set of classes is already part of MPI.

MPI-2 includes C++ bindings as part of its function specifications. In some cases, MPI-2 provides new names for the C bindings of MPI-1 functions. In this case, the C++ binding matches the new C name — there is no binding for the deprecated name.

16.1.2 Design

The C++ language interface for MPI is designed according to the following criteria:

1. The C++ language interface consists of a small set of classes with a lightweight functional interface to MPI. The classes are based upon the fundamental MPI object types (e.g., communicator, group, etc.).
2. The MPI C++ language bindings provide a semantically correct interface to MPI.
3. To the greatest extent possible, the C++ bindings for MPI functions are member functions of MPI classes.

Rationale. Providing a lightweight set of MPI objects that correspond to the basic MPI types is the best fit to MPI's implicit object-based design; methods can be supplied for these objects to realize MPI functionality. The existing C bindings can be used in C++ programs, but much of the expressive power of the C++ language is forfeited. On the other hand, while a comprehensive class library would make user programming more elegant, such a library it is not suitable as a language binding for MPI since a binding must provide a direct and unambiguous mapping to the specified functionality of MPI. (*End of rationale.*)

16.1.3 C++ Classes for MPI

All MPI classes, constants, and functions are declared within the scope of an MPI `namespace`. Thus, instead of the `MPI_` prefix that is used in C and Fortran, MPI functions essentially have an `MPI::` prefix.

The members of the MPI namespace are those classes corresponding to objects implicitly used by MPI. An abbreviated definition of the MPI namespace and its member classes is as follows:

```

namespace MPI {
  class Comm                {...};
  class Intracomm : public Comm  {...};
  class Graphcomm : public Intracomm  {...};
  class Distgraphcomm : public Intracomm {...};
  class Cartcomm  : public Intracomm  {...};
  class Intercomm : public Comm       {...};
  class Datatype  {...};
  class Errhandler  {...};
  class Exception  {...};
  class File       {...};
  class Group      {...};
  class Info       {...};
  class Op         {...};
  class Request    {...};
  class Prequest   : public Request    {...};
  class Grequest   : public Request    {...};
  class Status     {...};
  class Win        {...};
};

```

Note that there are a small number of derived classes, and that virtual inheritance is *not* used.

16.1.4 Class Member Functions for MPI

Besides the member functions which constitute the C++ language bindings for MPI, the C++ language interface has additional functions (as required by the C++ language). In particular, the C++ language interface must provide a constructor and destructor, an assignment operator, and comparison operators.

The complete set of C++ language bindings for MPI is presented in Annex [A.5](#). The bindings take advantage of some important C++ features, such as references and `const`. Declarations (which apply to all MPI member classes) for construction, destruction, copying, assignment, comparison, and mixed-language operability are also provided.

Except where indicated, all non-static member functions (except for constructors and the assignment operator) of MPI member classes are virtual functions.

Rationale. Providing virtual member functions is an important part of design for inheritance. Virtual functions can be bound at run-time, which allows users of libraries to re-define the behavior of objects already contained in a library. There is a small

performance penalty that must be paid (the virtual function must be looked up before it can be called). However, users concerned about this performance penalty can force compile-time function binding. (*End of rationale.*)

Example 16.1 Example showing a derived MPI class.

```
class foo_comm : public MPI::Intracomm {
public:
    void Send(const void* buf, int count, const MPI::Datatype& type,
              int dest, int tag) const
    {
        // Class library functionality
        MPI::Intracomm::Send(buf, count, type, dest, tag);
        // More class library functionality
    }
};
```

Advice to implementors. Implementors must be careful to avoid unintended side effects from class libraries that use inheritance, especially in layered implementations. For example, if MPI_BCAST is implemented by repeated calls to MPI_SEND or MPI_RECV, the behavior of MPI_BCAST cannot be changed by derived communicator classes that might redefine MPI_SEND or MPI_RECV. The implementation of MPI_BCAST must explicitly use the MPI_SEND (or MPI_RECV) of the base MPI::Comm class. (*End of advice to implementors.*)

16.1.5 Semantics

The semantics of the member functions constituting the C++ language binding for MPI are specified by the MPI function description itself. Here, we specify the semantics for those portions of the C++ language interface that are not part of the language binding. In this subsection, functions are prototyped using the type MPI::<CLASS> rather than listing each function for every MPI class; the word <CLASS> can be replaced with any valid MPI class name (e.g., Group), except as noted.

Construction / Destruction The default constructor and destructor are prototyped as follows:

```
{ MPI::<CLASS>() (binding deprecated, see Section 15.2) }
{ ~MPI::<CLASS>() (binding deprecated, see Section 15.2) }
```

In terms of construction and destruction, opaque MPI user level objects behave like handles. Default constructors for all MPI objects except MPI::Status create corresponding MPI::*_NULL handles. That is, when an MPI object is instantiated, comparing it with its corresponding MPI::*_NULL object will return true. The default constructors do not create new MPI opaque objects. Some classes have a member function Create() for this purpose.

Example 16.2 In the following code fragment, the test will return true and the message will be sent to cout.

```

1 void foo()
2 {
3     MPI::Intracomm bar;
4
5     if (bar == MPI::COMM_NULL)
6         cout << "bar is MPI::COMM_NULL" << endl;
7 }
8

```

The destructor for each MPI user level object does *not* invoke the corresponding `MPI_*_FREE` function (if it exists).

Rationale. `MPI_*_FREE` functions are not automatically invoked for the following reasons:

1. Automatic destruction contradicts the shallow-copy semantics of the MPI classes.
2. The model put forth in MPI makes memory allocation and deallocation the responsibility of the user, not the implementation.
3. Calling `MPI_*_FREE` upon destruction could have unintended side effects, including triggering collective operations (this also affects the copy, assignment, and construction semantics). In the following example, we would want neither `foo_comm` nor `bar_comm` to automatically invoke `MPI_*_FREE` upon exit from the function.

```

23 void example_function()
24 {
25     MPI::Intracomm foo_comm(MPI::COMM_WORLD), bar_comm;
26     bar_comm = MPI::COMM_WORLD.Dup();
27     // rest of function
28 }
29

```

(End of rationale.)

Copy / Assignment The copy constructor and assignment operator are prototyped as follows:

```

34 { MPI::<CLASS>(const MPI::<CLASS>& data) (binding deprecated, see Section 15.2) }
35
36 { MPI::<CLASS>& MPI::<CLASS>::operator=(const MPI::<CLASS>& data) (binding
37     deprecated, see Section 15.2) }
38

```

In terms of copying and assignment, opaque MPI user level objects behave like handles. Copy constructors perform handle-based (shallow) copies. `MPI::Status` objects are exceptions to this rule. These objects perform deep copies for assignment and copy construction.

Advice to implementors. Each MPI user level object is likely to contain, by value or by reference, implementation-dependent state information. The assignment and copying of MPI object handles may simply copy this value (or reference). *(End of advice to implementors.)*

Example 16.3 Example using assignment operator. In this example, `MPI::Intracomm::Dup()` is *not* called for `foo_comm`. The object `foo_comm` is simply an alias for `MPI::COMM_WORLD`. But `bar_comm` is created with a call to `MPI::Intracomm::Dup()` and is therefore a different communicator than `foo_comm` (and thus different from `MPI::COMM_WORLD`). `baz_comm` becomes an alias for `bar_comm`. If one of `bar_comm` or `baz_comm` is freed with `MPI_COMM_FREE` it will be set to `MPI::COMM_NULL`. The state of the other handle will be undefined — it will be invalid, but not necessarily set to `MPI::COMM_NULL`.

```
MPI::Intracomm foo_comm, bar_comm, baz_comm;

foo_comm = MPI::COMM_WORLD;
bar_comm = MPI::COMM_WORLD.Dup();
baz_comm = bar_comm;
```

Comparison The comparison operators are prototyped as follows:

```
{bool MPI::<CLASS>::operator==(const MPI::<CLASS>& data) const(binding
depreciated, see Section 15.2) }

{bool MPI::<CLASS>::operator!=(const MPI::<CLASS>& data) const(binding
depreciated, see Section 15.2) }
```

The member function `operator==(())` returns `true` only when the handles reference the same internal MPI object, `false` otherwise. `operator!=(())` returns the boolean complement of `operator==(())`. However, since the `Status` class is not a handle to an underlying MPI object, it does not make sense to compare `Status` instances. Therefore, the `operator==(())` and `operator!=(())` functions are not defined on the `Status` class.

Constants Constants are singleton objects and are declared `const`. Note that not all globally defined MPI objects are constant. For example, `MPI::COMM_WORLD` and `MPI::COMM_SELF` are not `const`.

16.1.6 C++ Datatypes

Table 16.1 lists all of the C++ predefined MPI datatypes and their corresponding C and C++ datatypes, Table 16.2 lists all of the Fortran predefined MPI datatypes and their corresponding Fortran 77 datatypes. Table 16.3 lists the C++ names for all other MPI datatypes.

`MPI::BYTE` and `MPI::PACKED` conform to the same restrictions as `MPI_BYTE` and `MPI_PACKED`, listed in Sections 3.2.2 on page 29 and Sections 4.2 on page 140, respectively.

The following table defines groups of MPI predefined datatypes:

C integer:	<code>MPI::INT</code> , <code>MPI::LONG</code> , <code>MPI::SHORT</code> , <code>MPI::UNSIGNED_SHORT</code> , <code>MPI::UNSIGNED</code> , <code>MPI::UNSIGNED_LONG</code> , <code>MPI::_LONG_LONG</code> , <code>MPI::UNSIGNED_LONG_LONG</code> , <code>MPI::SIGNED_CHAR</code> , <code>MPI::UNSIGNED_CHAR</code>
Fortran integer:	<code>MPI::INTEGER</code> and handles returned from

MPI datatype	C datatype	C++ datatype
MPI::CHAR	char	char
MPI::SHORT	signed short	signed short
MPI::INT	signed int	signed int
MPI::LONG	signed long	signed long
MPI::LONG_LONG	signed long long	signed long long
MPI::SIGNED_CHAR	signed char	signed char
MPI::UNSIGNED_CHAR	unsigned char	unsigned char
MPI::UNSIGNED_SHORT	unsigned short	unsigned short
MPI::UNSIGNED	unsigned int	unsigned int
MPI::UNSIGNED_LONG	unsigned long	unsigned long int
MPI::UNSIGNED_LONG_LONG	unsigned long long	unsigned long long
MPI::FLOAT	float	float
MPI::DOUBLE	double	double
MPI::LONG_DOUBLE	long double	long double
MPI::BOOL		bool
MPI::COMPLEX		Complex<float>
MPI::DOUBLE_COMPLEX		Complex<double>
MPI::LONG_DOUBLE_COMPLEX		Complex<long double>
MPI::WCHAR	wchar_t	wchar_t
MPI::BYTE		
MPI::PACKED		

Table 16.1: C++ names for the MPI C and C++ predefined datatypes, and their corresponding C/C++ datatypes.

MPI datatype	Fortran datatype
MPI::INTEGER	INTEGER
MPI::REAL	REAL
MPI::DOUBLE_PRECISION	DOUBLE PRECISION
MPI::F_COMPLEX	COMPLEX
MPI::LOGICAL	LOGICAL
MPI::CHARACTER	CHARACTER(1)
MPI::BYTE	
MPI::PACKED	

Table 16.2: C++ names for the MPI Fortran predefined datatypes, and their corresponding Fortran 77 datatypes.

MPI datatype	Description
MPI::FLOAT_INT	C/C++ reduction type
MPI::DOUBLE_INT	C/C++ reduction type
MPI::LONG_INT	C/C++ reduction type
MPI::TWOINT	C/C++ reduction type
MPI::SHORT_INT	C/C++ reduction type
MPI::LONG_DOUBLE_INT	C/C++ reduction type
MPI::TWOREAL	Fortran reduction type
MPI::TWODOUBLE_PRECISION	Fortran reduction type
MPI::TWOINTEGER	Fortran reduction type
MPI::F_DOUBLE_COMPLEX	Optional Fortran type
MPI::INTEGER1	Explicit size type
MPI::INTEGER2	Explicit size type
MPI::INTEGER4	Explicit size type
MPI::INTEGER8	Explicit size type
MPI::INTEGER16	Explicit size type
MPI::REAL2	Explicit size type
MPI::REAL4	Explicit size type
MPI::REAL8	Explicit size type
MPI::REAL16	Explicit size type
MPI::F_COMPLEX4	Explicit size type
MPI::F_COMPLEX8	Explicit size type
MPI::F_COMPLEX16	Explicit size type
MPI::F_COMPLEX32	Explicit size type

Table 16.3: C++ names for other MPI datatypes. Implementations may also define other optional types (e.g., `MPI::INTEGER8`).

```

1      MPI::Datatype::Create_f90_integer,
2      and if available: MPI::INTEGER1,
3      MPI::INTEGER2, MPI::INTEGER4,
4      MPI::INTEGER8, MPI::INTEGER16
5      Floating point: MPI::FLOAT, MPI::DOUBLE, MPI::REAL,
6      MPI::DOUBLE_PRECISION,
7      MPI::LONG_DOUBLE
8      and handles returned from
9      MPI::Datatype::Create_f90_real,
10     and if available: MPI::REAL2,
11     MPI::REAL4, MPI::REAL8, MPI::REAL16
12     Logical: MPI::LOGICAL, MPI::BOOL
13     Complex: MPI::F_COMPLEX, MPI::COMPLEX,
14     MPI::F_DOUBLE_COMPLEX,
15     MPI::DOUBLE_COMPLEX,
16     MPI::LONG_DOUBLE_COMPLEX
17     and handles returned from
18     MPI::Datatype::Create_f90_complex,
19     and if available: MPI::F_DOUBLE_COMPLEX,
20     MPI::F_COMPLEX4, MPI::F_COMPLEX8,
21     MPI::F_COMPLEX16, MPI::F_COMPLEX32
22     Byte: MPI::BYTE

```

Valid datatypes for each reduction operation are specified below in terms of the groups defined above.

Op	Allowed Types
MPI::MAX, MPI::MIN	C integer, Fortran integer, Floating point
MPI::SUM, MPI::PROD	C integer, Fortran integer, Floating point, Complex
MPI::LAND, MPI::LOR, MPI::LXOR	C integer, Logical
MPI::BAND, MPI::BOR, MPI::BXOR	C integer, Fortran integer, Byte

MPI::MINLOC and MPI::MAXLOC perform just as their C and Fortran counterparts; see Section 5.9.4 on page 191.

16.1.7 Communicators

The `MPI::Comm` class hierarchy makes explicit the different kinds of communicators implicitly defined by MPI and allows them to be strongly typed. Since the original design of MPI defined only one type of handle for all types of communicators, the following clarifications are provided for the C++ design.

Types of communicators There are six different types of communicators: `MPI::Comm`, `MPI::Intercomm`, `MPI::Intracomm`, `MPI::Cartcomm`, `MPI::Graphcomm`, and `MPI::Distgraphcomm`. `MPI::Comm` is the abstract base communicator class, encapsulating the functionality common to all MPI communicators. `MPI::Intercomm` and `MPI::Intracomm` are derived from `MPI::Comm`. `MPI::Cartcomm`, `MPI::Graphcomm`, and `MPI::Distgraphcomm` are derived from `MPI::Intracomm`.

Advice to users. Initializing a derived class with an instance of a base class is not [legal]valid in C++. For instance, it is not [legal]valid to initialize a Cartcomm from an Intracomm. Moreover, because MPI::Comm is an abstract base class, it is non-instantiable, so that it is not possible to have an object of class MPI::Comm. However, it is possible to have a reference or a pointer to an MPI::Comm.

Example 16.4 The following code is erroneous.

```
Intracomm intra = MPI::COMM_WORLD.Dup();
Cartcomm cart(intra);           // This is erroneous
```

(End of advice to users.)

MPI::COMM_NULL The specific type of MPI::COMM_NULL is implementation dependent. MPI::COMM_NULL must be able to be used in comparisons and initializations with all types of communicators. MPI::COMM_NULL must also be able to be passed to a function that expects a communicator argument in the parameter list (provided that MPI::COMM_NULL is an allowed value for the communicator argument).

Rationale. There are several possibilities for implementation of MPI::COMM_NULL. Specifying its required behavior, rather than its realization, provides maximum flexibility to implementors. *(End of rationale.)*

Example 16.5 The following example demonstrates the behavior of assignment and comparison using MPI::COMM_NULL.

```
MPI::Intercomm comm;
comm = MPI::COMM_NULL;           // assign with COMM_NULL
if (comm == MPI::COMM_NULL)     // true
    cout << "comm is NULL" << endl;
if (MPI::COMM_NULL == comm)    // note -- a different function!
    cout << "comm is still NULL" << endl;
```

Dup() is not defined as a member function of MPI::Comm, but it is defined for the derived classes of MPI::Comm. Dup() is not virtual and it returns its OUT parameter by value.

MPI::Comm::Clone() The C++ language interface for MPI includes a new function Clone(). MPI::Comm::Clone() is a pure virtual function. For the derived communicator classes, Clone() behaves like Dup() except that it returns a new object by reference. The Clone() functions are prototyped as follows:

```
Comm& Comm::Clone() const = 0

Intracomm& Intracomm::Clone() const

Intercomm& Intercomm::Clone() const

Cartcomm& Cartcomm::Clone() const

Graphcomm& Graphcomm::Clone() const
```

```
1 Distgraphcomm& Distgraphcomm::Clone() const
```

3 *Rationale.* Clone() provides the “virtual dup” functionality that is expected by C++
4 programmers and library writers. Since Clone() returns a new object by reference,
5 users are responsible for eventually deleting the object. A new name is introduced
6 rather than changing the functionality of Dup(). (*End of rationale.*)

8 *Advice to implementors.* Within their class declarations, prototypes for Clone() and
9 Dup() would look like the following:

```
10 namespace MPI {
11     class Comm {
12         virtual Comm& Clone() const = 0;
13     };
14     class Intracomm : public Comm {
15         Intracomm Dup() const { ... };
16         virtual Intracomm& Clone() const { ... };
17     };
18     class Intercomm : public Comm {
19         Intercomm Dup() const { ... };
20         virtual Intercomm& Clone() const { ... };
21     };
22     // Cartcomm, Graphcomm,
23     // and Distgraphcomm are similarly defined
24 };
```

26 (*End of advice to implementors.*)

28 16.1.8 Exceptions

30 The C++ language interface for MPI includes the predefined error handler
31 MPI::ERRORS_THROW_EXCEPTIONS for use with the Set_errhandler() member functions.
32 MPI::ERRORS_THROW_EXCEPTIONS can only be set or retrieved by C++ functions. If a
33 non-C++ program causes an error that invokes the MPI::ERRORS_THROW_EXCEPTIONS error
34 handler, the exception will pass up the calling stack until C++ code can catch it. If there
35 is no C++ code to catch it, the behavior is undefined. In a multi-threaded environment
36 or if a nonblocking MPI call throws an exception while making progress in the background,
37 the behavior is implementation dependent.

38 The error handler MPI::ERRORS_THROW_EXCEPTIONS causes an MPI::Exception to be
39 thrown for any MPI result code other than MPI::SUCCESS. The public interface to
40 MPI::Exception class is defined as follows:

```
41 namespace MPI {
42     class Exception {
43     public:
44
45         Exception(int error_code);
46
47         int Get_error_code() const;
48     };
```



```

    int Get_error_class() const;
    const char *Get_error_string() const;
};
};

```

Advice to implementors.

The exception will be thrown within the body of `MPI::ERRORS_THROW_EXCEPTIONS`. It is expected that control will be returned to the user when the exception is thrown. Some MPI functions specify certain return information in their parameters in the case of an error and `MPI_ERRORS_RETURN` is specified. The same type of return information must be provided when exceptions are thrown.

For example, `MPI_WAITALL` puts an error code for each request in the corresponding entry in the status array and returns `MPI_ERR_IN_STATUS`. When using `MPI::ERRORS_THROW_EXCEPTIONS`, it is expected that the error codes in the status array will be set appropriately before the exception is thrown.

(End of advice to implementors.)

16.1.9 Mixed-Language Operability

The C++ language interface provides functions listed below for mixed-language operability. These functions provide for a seamless transition between C and C++. For the case where the C++ class corresponding to `<CLASS>` has derived classes, functions are also provided for converting between the derived classes and the C `MPI_<CLASS>`.

```
MPI::<CLASS>& MPI::<CLASS>::operator=(const MPI_<CLASS>& data)
```

```
MPI::<CLASS>(const MPI_<CLASS>& data)
```

```
MPI::<CLASS>::operator MPI_<CLASS>() const
```

These functions are discussed in Section [16.3.4](#).

16.1.10 Profiling

This section specifies the requirements of a C++ profiling interface to MPI.

Advice to implementors. Since the main goal of profiling is to intercept function calls from user code, it is the implementor's decision how to layer the underlying implementation to allow function calls to be intercepted and profiled. If an implementation of the MPI C++ bindings is layered on top of MPI bindings in another language (such as C), or if the C++ bindings are layered on top of a profiling interface in another language, no extra profiling interface is necessary because the underlying MPI implementation already meets the MPI profiling interface requirements.

Native C++ MPI implementations that do not have access to other profiling interfaces must implement an interface that meets the requirements outlined in this section.

High-quality implementations can implement the interface outlined in this section in order to promote portable C++ profiling libraries. Implementors may wish to provide an option whether to build the C++ profiling interface or not; C++ implementations that are already layered on top of bindings in another language or another profiling

1 interface will have to insert a third layer to implement the C++ profiling interface.
 2 (*End of advice to implementors.*)

3
 4 To meet the requirements of the C++ MPI profiling interface, an implementation of
 5 the MPI functions *must*:

- 6 1. Provide a mechanism through which all of the MPI defined functions may be accessed
 7 with a name shift. Thus all of the MPI functions (which normally start with the prefix
 8 “MPI:”) should also be accessible with the prefix “PMPI:.”
 9
- 10 2. Ensure that those MPI functions which are not replaced may still be linked into an
 11 executable image without causing name clashes.
- 12 3. Document the implementation of different language bindings of the MPI interface if
 13 they are layered on top of each other, so that profiler developer knows whether they
 14 must implement the profile interface for each binding, or can economize by imple-
 15 menting it only for the lowest level routines.
- 16 4. Where the implementation of different language bindings is done through a layered
 17 approach (e.g., the C++ binding is a set of “wrapper” functions which call the C
 18 implementation), ensure that these wrapper functions are separable from the rest of
 19 the library.

20 This is necessary to allow a separate profiling library to be correctly implemented,
 21 since (at least with Unix linker semantics) the profiling library must contain these
 22 wrapper functions if it is to perform as expected. This requirement allows the author
 23 of the profiling library to extract these functions from the original MPI library and add
 24 them into the profiling library without bringing along any other unnecessary code.

- 25 5. Provide a no-op routine MPI:Pcontrol in the MPI library.

26
 27 *Advice to implementors.* There are (at least) two apparent options for implementing
 28 the C++ profiling interface: inheritance or caching. An inheritance-based approach
 29 may not be attractive because it may require a virtual inheritance implementation of
 30 the communicator classes. Thus, it is most likely that implementors will cache PMPI
 31 objects on their corresponding MPI objects. The caching scheme is outlined below.

32 The “real” entry points to each routine can be provided within a `namespace PMPI`.
 33 The non-profiling version can then be provided within a `namespace MPI`.

34 Caching instances of PMPI objects in the MPI handles provides the “has a” relationship
 35 that is necessary to implement the profiling scheme.

36 Each instance of an MPI object simply “wraps up” an instance of a PMPI object. MPI
 37 objects can then perform profiling actions before invoking the corresponding function
 38 in their internal PMPI object.

39 The key to making the profiling work by simply re-linking programs is by having
 40 a header file that *declares* all the MPI functions. The functions must be *defined*
 41 elsewhere, and compiled into a library. MPI constants should be declared `extern`
 42 in the MPI namespace. For example, the following is an excerpt from a sample `mpi.h`
 43 file:

44
 45
 46
 47
 48 **Example 16.6** Sample `mpi.h` file.

```

namespace PMPI {
    class Comm {
    public:
        int Get_size() const;
    };
    // etc.
};

namespace MPI {
public:
    class Comm {
    public:
        int Get_size() const;

    private:
        PMPI::Comm pmpi_comm;
    };
};

```

Note that all constructors, the assignment operator, and the destructor in the `MPI` class will need to initialize/destroy the internal `PMPI` object as appropriate.

The definitions of the functions must be in separate object files; the `PMPI` class member functions and the non-profiling versions of the `MPI` class member functions can be compiled into `libmpi.a`, while the profiling versions can be compiled into `libpmpi.a`. Note that the `PMPI` class member functions and the `MPI` constants must be in different object files than the non-profiling `MPI` class member functions in the `libmpi.a` library to prevent multiple definitions of `MPI` class member function names when linking both `libmpi.a` and `libpmpi.a`. For example:

Example 16.7 `pmpi.cc`, to be compiled into `libmpi.a`.

```

int PMPI::Comm::Get_size() const
{
    // Implementation of MPI_COMM_SIZE
}

```

Example 16.8 `constants.cc`, to be compiled into `libmpi.a`.

```

const MPI::Intracomm MPI::COMM_WORLD;

```

Example 16.9 `mpi_no_profile.cc`, to be compiled into `libmpi.a`.

```

int MPI::Comm::Get_size() const
{
    return pmpi_comm.Get_size();
}

```

Example 16.10 `mpi_profile.cc`, to be compiled into `libmpi.a`.

```

1  int MPI::Comm::Get_size() const
2
3  {
4
5      // Do profiling stuff
6      int ret = pmpi_comm.Get_size();
7      // More profiling stuff
8      return ret;
9  }

```

(*End of advice to implementors.*)

16.2 Fortran Support

16.2.1 Overview

The Fortran [MPI-2]MPI language bindings have been designed to be compatible with the Fortran 90 standard [(and later)]with additional features from Fortran 2003 and Fortran 2008 [39] + TR 29113 [41]. [These bindings are in most cases compatible with Fortran 77, implicit-style interfaces.]

Rationale. Fortran 90 contains numerous features designed to make it a more “modern” language than Fortran 77. It seems natural that [MPI]MPI should be able to take advantage of these new features with a set of bindings tailored to Fortran 90. [MPI does not (yet) use many of these features because of a number of technical difficulties.]In Fortran 2008 + TR 29113, the major new language features used are the **ASYNCHRONOUS** attribute to protect nonblocking MPI operations, and assumed-type and assumed-rank dummy arguments for choice buffer arguments. Further requirements for compiler support are listed in Section 16.2.7 on page 661. (*End of rationale.*)

MPI defines [two levels]three methods of Fortran support[, described in Sections 16.2.4 and 16.2.3. In the rest of this section, “Fortran” and “Fortran 90” shall refer to “Fortran 90” and its successors, unless qualified.]:

1. **USE mpi_f08:** This method is described in Section 16.2.2 and requires compile-time argument checking with unique MPI handle types and provides techniques to fully solve the optimization problems with nonblocking calls. This is the only Fortran support method that is consistent with the Fortran standard (Fortran 2008 + TR 29113 and later). This method is highly recommended for all MPI applications.
2. [Extended Fortran Support]**USE mpi:** [An implementation with this level of Fortran support provides Basic Fortran Support plus additional features that specifically support Fortran 90, as]This method is described in Section 16.2.3 and requires compile-time argument checking. Handles are defined as **INTEGER**. This Fortran support method is inconsistent with the Fortran standard, and its use is therefore not recommended. It exists only for backwards compatibility.
3. [Basic Fortran Support]**INCLUDE 'mpif.h':** [An implementation with this level of Fortran support provides the original Fortran bindings specified in MPI-1, with small

ticket233-E.

additional requirements specified] This method is described in Section 16.2.4. The use of the include file `mpif.h` is strongly discouraged starting with MPI-3.0, because this method neither guarantees compile-time argument checking nor provides sufficient techniques to solve the optimization problems with nonblocking calls, and is therefore inconsistent with the Fortran standard. It exists only for backwards compatibility with legacy MPI applications.

[A compliant MPI-2] Compliant MPI-3 implementations providing a Fortran interface must provide [Extended Fortran Support unless the target compiler does not support modules or KIND-parameterized types] [all three Fortran support methods.] provide one or both of the following:

- The `USE mpi_f08` Fortran support method.
- The `USE mpi` and `INCLUDE 'mpif.h'` Fortran support methods.

Section 16.2.6 on page 658 describes restrictions if the compiler does not support all the needed features.

Application[s] subroutines and functions may use either [the `mpi`] one of the modules or the `mpif.h` include file. An implementation may require the use of one of the modules to prevent type mismatch errors [(see below)].

Advice to users. [It is recommended to use the `mpi` module even if it is not necessary to use it to avoid type mismatch errors] Users are advised to utilize one of the MPI modules even if `mpif.h` enforces type checking on a particular system. Using a module provides several potential advantages over using an include file; the `mpi_f08` module offers the most [advantages] robust and complete Fortran support. (*End of advice to users.*)

[It] In a single application, it must be possible to link together routines [some of which `USE mpi` and others of which `INCLUDE 'mpif.h'`.] which `USE mpi_f08`, `USE mpi`, and `INCLUDE mpif.h`.

The `INTEGER` compile-time constant `MPI_SUBARRAYS_SUPPORTED` is set to `.TRUE.` if all buffer choice arguments are defined in explicit interfaces with assumed-type and assumed-rank [41]; otherwise it is set to `.FALSE.`. The `INTEGER` compile-time constant `MPI_ASYNC_PROTECTS_NONBLOCKING` is set to `.TRUE.` if the `ASYNCHRONOUS` attribute was added to the choice buffer arguments of all nonblocking interfaces **and** the underlying Fortran compiler supports the `ASYNCHRONOUS` attribute for MPI communication (as part of TR 29113), otherwise it is set to `.FALSE.`. These constants exist with each Fortran support method, but not in the C/C++ header files. The values may be different for each Fortran support method. All other constants and the integer values of handles must be the same for each Fortran support method.

Section 16.2.2 through 16.2.4 define the Fortran support methods. The Fortran interfaces of each MPI routine are shorthands. Section 16.2.5 defines the corresponding full interface specification together with the used linker names and implications for the profiling interface. Section 16.2.6 the implementation of the MPI routines for different versions of the Fortran standard. Section 16.2.7 summarizes major requirements for valid MPI-3.0 implementations with Fortran support. Section 16.2.8 and Section 16.2.9 describe additional functionality that is part of the Fortran support. `MPI_F_SYNC_REG` is needed for one of the methods to prevent register optimization problems. A [new] set

of functions [to] provides additional support for Fortran intrinsic numeric types, including parameterized types: `MPI_SIZEOF`, `MPI_TYPE_MATCH_SIZE`, `MPI_TYPE_CREATE_F90_INTEGER`, `MPI_TYPE_CREATE_F90_REAL` and `MPI_TYPE_CREATE_F90_COMPLEX`. [Parameterized] In the context of MPI, parameterized types are Fortran intrinsic types which are specified using `KIND` type parameters. [These routines are described in detail in Section 16.2.9.] Sections 16.2.10 through 16.2.19 give an overview and details on known problems when using Fortran together with MPI; Section 16.2.20 compares the Fortran problems with those in C.

16.2.2 Fortran Support Through the `mpi_f08` Module

An MPI implementation providing a Fortran interface must provide a module named `mpi_f08` that can be used in a Fortran program. Section 16.2.6 on page 658 describes restrictions if the compiler does not support all the needed features. Within all MPI function specifications, the first of the set of two Fortran routine interface specifications is provided by this module. This module must:

- Define all named MPI constants.
- Declare MPI functions that return a value.
- Provide explicit interfaces according to the Fortran routine interface specifications. This module therefore guarantees compile-time argument checking for all arguments which are not `TYPE(*)`, with the following exception:

Only one Fortran interface is defined for functions that are deprecated as of MPI-3.0. This interface must be provided as an explicit interface according to the rules defined for the `mpi` module, see Section 16.2.3 on page 648.

Advice to users. It is strongly recommended that developers substitute calls to deprecated routines when upgrading from `mpif.h` or the `mpi` module to the `mpi_f08` module. (*End of advice to users.*)

- Define all MPI handles with uniquely named handle types (instead of `INTEGER` handles, as in the `mpi` module). This is reflected in the first Fortran binding in each MPI function definition throughout this document (except for the deprecated routines).
- Overload the operators `.EQ.` and `.NE.` to allow the comparison of these MPI handles with `.EQ.`, `.NE.`, `==` and `/=`.
- Use the `ASYNCHRONOUS` attribute to protect the buffers of nonblocking operations, and set the `INTEGER` compile-time constant `MPI_ASYNC_PROTECTS_NONBLOCKING` to `.TRUE.` if the underlying Fortran compiler supports the `ASYNCHRONOUS` attribute for MPI communication (as part of TR 29113). See Section 16.2.6 on page 658 for older compiler versions.
- Set the `INTEGER` compile-time constant `MPI_SUBARRAYS_SUPPORTED` to `.TRUE.` and declare choice buffers using the Fortran 2008 TR 29113 feature assumed-type and assumed-rank, i.e., `TYPE(*)`, `DIMENSION(..)` in all nonblocking, split collective and persistent communication routines, if the underlying Fortran compiler supports it. With this, non-contiguous sub-arrays can be used as buffers in nonblocking routines.

Rationale. In all blocking routines, i.e., if the choice-buffer is not declared as `ASYNCHRONOUS`, the TR 29113 feature is not needed for the support of non-contiguous buffers because the compiler can pass the buffer by in-and-out-copy through a contiguous scratch array. (*End of rationale.*)

- Set the `MPI_SUBARRAYS_SUPPORTED` compile-time constant to `.FALSE.` and declare choice buffers with a compiler-dependent mechanism that overrides type checking if the underlying Fortran compiler does not support the Fortran 2008 TR 29113 assumed-type and assumed-rank notation. In this case, the use of non-contiguous sub-arrays as buffers in nonblocking calls may be invalid. See Section 16.2.6 on page 658 for details.

- Declare each argument with an `INTENT` of `IN`, `OUT`, or `INOUT` as defined in this standard.

Rationale. For these definitions in the `mpi_f08` bindings, in most cases, `INTENT(IN)` is used if the C interface uses call-by-value. For all buffer arguments and for `OUT` and `INOUT` dummy arguments that allow one of the non-ordinary Fortran constants (see `MPI_BOTTOM`, etc. in Section 2.5.4 on page 15) as input, an `INTENT` is not specified. (*End of rationale.*)

Advice to users. If a dummy argument is declared with `INTENT(OUT)`, then the Fortran standard stipulates that the actual argument becomes undefined upon invocation of the MPI routine, i.e., it may be overwritten by some other values, e.g. zeros; according to [39], 12.5.2.4 Ordinary dummy variables, Paragraph 17: “If a dummy argument has `INTENT(OUT)`, the actual argument becomes undefined at the time the association is established, except [...]”. For example, if the dummy argument is an assumed-size array and the actual argument is a strided array, the call may be implemented with copy-in and copy-out of the argument. In the case of `INTENT(OUT)` the copy-in may be suppressed by the optimization and the routine starts execution using an array of undefined values. If the routine stores fewer elements into the dummy argument than is provided in the actual argument, then the remaining locations are overwritten with these undefined values. See also both advices to implementors in Section 16.2.3 on page 648. (*End of advice to users.*)

- Declare all `ierror` output arguments as `OPTIONAL`, except for user-defined callback functions (e.g., `COMM_COPY_ATTR_FUNCTION`) and predefined callbacks (e.g., `MPI_NULL_COPY_FN`).

Rationale. For user-defined callback functions (e.g., `COMM_COPY_ATTR_FUNCTION`) and their predefined callbacks (e.g., `MPI_NULL_COPY_FN`), the `ierror` argument is not optional. The MPI library must always call these routines with an actual `ierror` argument. Therefore, these user-defined functions need not check whether the MPI library calls these routines with or without an actual `ierror` output argument. (*End of rationale.*)

The MPI Fortran bindings in the `mpi_f08` module are designed based on the Fortran 2008 standard [39] together with the Technical Report “TR 29113 Further Interoperability with C” [41] of the ISO/IEC JTC1/SC22/WG5 (Fortran) working group.

Rationale. The features in TR 29113 on further interoperability with C were decided on by ISO/IEC JTC1/SC22/WG5 and designed by PL22.3 (formerly J3) to support a higher level of integration between Fortran-specific features and C than was provided in the Fortran 2008 standard; part of this design is based on requirements from the MPI Forum to support MPI-3.0. According to [40] page iv, last paragraph, “it is the intention of ISO/IEC JTC1/SC22/WG5 that the semantics and syntax specified by this technical report be included in the next revision of the Fortran International Standard without change unless experience in the implementation and use of this feature identifies errors that need to be corrected, or changes are needed to achieve proper integration, in which case every reasonable effort will be made to minimize the impact of such changes on existing implementations”.

The TR 29113 contains the following language features that are needed for the MPI bindings in the `mpi_f08` module: assumed-type and assumed-rank. It is important that any possible actual argument can be used for such dummy arguments, e.g., scalars, arrays, assumed-shape arrays, assumed-size arrays, allocatable arrays, and with any element type, e.g., `REAL`, `CHARACTER*5`, `CHARACTER(*)`, sequence derived types, or `BIND(C)` derived types. Especially for backward compatibility reasons, it is important that any possible actual argument in an implicit interface implementation of a choice buffer dummy argument (e.g., with `mpif.h` without argument-checking) can be used in an implementation with assumed-type and assumed-rank argument in an explicit interface (e.g., with the `mpi_f08` module).

The `INTERFACE` construct in combination with `BIND(C)` allows the implementation of the Fortran `mpi_f08` interface with a single set of portable wrapper routines written in C, which supports all desired features in the `mpi_f08` interface. TR 29113 also has a provision for `OPTIONAL` arguments in `BIND(C)` interfaces.

A further feature useful for MPI is the extension of the semantics of the `ASYNCHRONOUS` attribute: In F2003 and F2008, this attribute could be used only to protect buffers of Fortran asynchronous I/O. With TR29113, this attribute now also covers asynchronous communication occurring within library routines written in C.

The MPI Forum hereby wishes to acknowledge this important effort by the Fortran PL22.3 and WG5 committee. (*End of rationale.*)

16.2.3 [Extended] Fortran Support Through the `mpi` Module

[Implementations with Extended Fortran support must provide:

1. An `mpi` module
2. (List item was moved to another location, and modified) A new set of functions to provide additional support for Fortran intrinsic numeric types, including parameterized types: `MPI_SIZEOF`, `MPI_TYPE_MATCH_SIZE`, `MPI_TYPE_CREATE_F90_INTEGER`, `MPI_TYPE_CREATE_F90_REAL` and

`MPI_TYPE_CREATE_F90_COMPLEX`. Parameterized types are Fortran intrinsic types which are specified using `KIND` type parameters. These routines are described in detail in Section 16.2.9.

Additionally, high-quality implementations should provide a mechanism to prevent fatal type mismatch errors for MPI routines with choice arguments.

The `mpi` Module

]

An MPI implementation providing a Fortran interface must provide a module named `mpi` that can be used in a Fortran [90] program. Within all MPI function specifications, the second of the set of two Fortran routine interface specifications is provided by this module. This module must:

- Define all named MPI constants
- Declare MPI functions that return a value.
- Provide explicit interfaces according to the Fortran routine interface specifications. This module therefore guarantees compile-time argument checking and allows positional and keyword-based argument lists.
- Define all MPI handles as type `INTEGER`.
- Define all named handle types and the derived type `MPI_Status` that are used in the `mpi_f08` module.

Rationale. They are needed only when the application converts old-style `INTEGER` handles into new-style handles with a named type. (*End of rationale.*)

- Overload the operators `.EQ.` and `.NE.` to allow the comparison of these MPI handles with `.EQ.`, `.NE.`, `==` and `/=`.
- A high quality MPI implementation may enhance the interface by using the `ASYNCHRONOUS` attribute in the same way as in the `mpi_f08` module if it is supported by the underlying compiler.
- Set the `INTEGER` compile-time constant `MPI_ASYNC_PROTECTS_NONBLOCKING` to `.TRUE.` if the `ASYNCHRONOUS` attribute is used in all nonblocking interfaces **and** the underlying Fortran compiler supports the `ASYNCHRONOUS` attribute for MPI communication (as part of TR 29113), otherwise to `.FALSE.`

Advice to users. For an MPI implementation that fully supports nonblocking calls with the `ASYNCHRONOUS` attribute for choice buffers, an existing MPI-2.2 application may fail to compile even if it compiled and executed with expected results with an MPI-2.2 implementation. One reason may be that the application uses ‘contiguous’ but not ‘simply contiguous’ `ASYNCHRONOUS` arrays as actual arguments for choice buffers of nonblocking routines, e.g., by using subscript triplets with stride one or specifying

1
2
3
4
5
6
7
8
9
10 ticket230-B.
11 ticket230-B.
12
13
14
15
16
17 ticket230-B.
18
19
20
21
22 ticket231-C.
23
24 ticket243-O
25 ticket231-C.
26 ticket231-C.
27
28
29 ticket229.7.
30
31
32 ticket238-J.
33
34
35
36
37 ticket229.1.
38
39
40
41 ticket247-S.
42
43
44
45
46 ticket229.1.
47 ticket229.1.
48

(1:n) for a whole dimension instead of using (:). This should be fixed to fulfill the Fortran constraints for `ASYNCHRONOUS` dummy arguments. This is not considered a violation of backward compatibility because existing applications can not use the `ASYNCHRONOUS` attribute to protect nonblocking calls. Another reason may be that the application does not conform either to MPI-2.2, or to MPI-3.0, or to the Fortran standard, typically because the program forces the compiler to perform copyin/out for a choice buffer argument in a nonblocking MPI call. This is also not a violation of backward compatibility because the application itself is non-conforming. See Section 16.2.12 on page 675 for more details. (*End of advice to users.*)

- A high quality MPI implementation may enhance the interface by using `TYPE(*)`, `DIMENSION(..)` choice buffer dummy arguments instead of using non-standardized extensions such as `!$PRAGMA IGNORE_TKR` or a set of overloaded functions as described by M. Hennecke in [28], if the compiler supports this TR 29113 language feature. See Section 16.2.6 on page 658 for further details.
- Set the `INTEGER` compile-time constant `MPI_SUBARRAYS_SUPPORTED` to `.TRUE.` if all choice buffer arguments in all nonblocking, split collective and persistent communication routines are declared with `TYPE(*)`, `DIMENSION(..)`, otherwise set it to `.FALSE.`. With `MPI_SUBARRAYS_SUPPORTED==.TRUE.`, non-contiguous sub-arrays can be used as buffers in nonblocking routines.
- Set the `MPI_SUBARRAYS_SUPPORTED` compile-time constant to `.FALSE.` and declare choice buffers with a compiler-dependent mechanism that overrides type checking if the underlying Fortran compiler does not support the TR 29113 assumed-type and assumed-rank features. In this case, the use of non-contiguous sub-arrays in nonblocking calls may be disallowed. See Section 16.2.6 on page 658 for details.

An MPI implementation may provide *other features* in the `mpi` module [*other features* that enhance the usability of MPI while maintaining adherence to the standard. For example, it may[:] provide `INTENT` information in these interface blocks. [

- Provide interfaces for all or for a subset of MPI routines.
- Provide `INTENT` information in these interface blocks.

]

Advice to implementors. The appropriate `INTENT` may be different from what is given in the MPI [*generic interface*] *language-neutral bindings*. Implementations must choose `INTENT` so that the function adheres to the MPI standard, e.g., by defining the `INTENT` as provided in the `mpi_f08` bindings. (*End of advice to implementors.*)

Rationale. The intent given by the MPI generic interface is not precisely defined and does not in all cases correspond to the correct Fortran `INTENT`. For instance, receiving into a buffer specified by a datatype with absolute addresses may require associating `MPI_BOTTOM` with a dummy `OUT` argument. Moreover, “constants” such as `MPI_BOTTOM` and `MPI_STATUS_IGNORE` are not constants as defined by Fortran, but “special addresses” used in a nonstandard way. Finally, the MPI-1 generic intent [*is*] was changed in several places [*by*] in MPI-2. For instance, `MPI_IN_PLACE` changes the [*sense*] intent of an `OUT` argument to be `INOUT`. (*End of rationale.*)

ticket242-N.

Advice to implementors. The Fortran 2008 standard illustrates in its Note 5.17 that “*INTENT(OUT)* means that the value of the argument after invoking the procedure is entirely the result of executing that procedure. If an argument should retain its value rather than being redefined, *INTENT(INOUT)* should be used rather than *INTENT(OUT)*, even if there is no explicit reference to the value of the dummy argument. Furthermore, *INTENT(INOUT)* is not equivalent to omitting the *INTENT* attribute, because *INTENT(INOUT)* always requires that the associated actual argument is *definable*”. Applications that include `mpif.h` may not expect that *INTENT(OUT)* is used. In particular, output array arguments are expected to keep their content as long as the MPI routine does not modify them. To keep this behavior, it is recommended that implementations not use *INTENT(OUT)* in the `mpi` module and the `mpif.h` include file, even though *INTENT(OUT)* is specified in an interface description of the `mpi_f08` module. (*End of advice to implementors.*)

[(Paragraph was moved to another location, and modified) Applications may use either the `mpi` module or the `mpif.h` include file. An implementation may require use of the module to prevent type mismatch errors (see below).

Advice to users. It is recommended to use the `mpi` module even if it is not necessary to use it to avoid type mismatch errors on a particular system. Using a module provides several potential advantages over using an include file. (*End of advice to users.*)

It must be possible to link together routines some of which `USE mpi` and others of which `INCLUDE mpif.h`]

[

No Type Mismatch Problems for Subroutines with Choice Arguments

A high-quality MPI implementation should provide a mechanism to ensure that MPI choice arguments do not cause fatal compile-time or run-time errors due to type mismatch. An MPI implementation may require applications to use the `mpi` module, or require that it be compiled with a particular compiler flag, in order to avoid type mismatch problems.

Advice to implementors. In the case where the compiler does not generate errors, nothing needs to be done to the existing interface. In the case where the compiler may generate errors, a set of overloaded functions may be used. See the paper of M. Hennecke [28]. Even if the compiler does not generate errors, explicit interfaces for all routines would be useful for detecting errors in the argument list. Also, explicit interfaces which give *INTENT* information can reduce the amount of copying for `BUF(*)` arguments. (*End of advice to implementors.*)

]

16.2.4 [Basic]Fortran Support Through the `mpif.h` Include File

The use of the `mpif.h` include file is strongly discouraged and may be deprecated in a future version of MPI.

1
2
3
4
5
6
7
8
9
10
11
12
13
14
15
16 ticket230-B.
17
18
19
20
21
22
23
24
25 ticket232-D.
26
27
28
29
30
31
32
33
34
35
36
37
38
39
40
41
42
43
44
45 ticket230-B.
46 ticket230-B.
47 ticket233-E.
48 ticket230-B.

[Because Fortran 90 is (for all practical purposes) a superset of Fortran 77, Fortran 90 (and future) programs can use the original Fortran interface.][The following additional requirements are added:] An MPI implementation providing a Fortran interface must provide an include file named `mpif.h` that can be used in a Fortran program. Within all MPI function specifications, the second of the set of two Fortran routine interface specifications is supported by this include file. This include file must:

1. Implementations are required to provide the file `mpif.h`, as described in the original MPI-1 specification.
2. `mpif.h` must be valid and equivalent for both fixed- and free- source form.

]

- Define all named MPI constants.
- Declare MPI functions that return a value.
- Define all handles as `INTEGER`.
- Be valid and equivalent for both fixed and free source form.

For each MPI routine, an implementation can choose to use an implicit or explicit interface for the second Fortran binding (in deprecated routines, the first one may be omitted).

- Set the `INTEGER` compile-time constants `MPI_SUBARRAYS_SUPPORTED` and `MPI_ASYNC_PROTECTS_NONBLOCKING` according to the same rules as for the `mpi` module. In the case of implicit interfaces for choice buffer or nonblocking routines, the constants must be set to `.FALSE..`

Advice to users. Instead of using `mpif.h`, the use of the `mpi_f08` or `mpi` module is strongly encouraged for the following reasons:

- Most `mpif.h` implementations do not include compile-time argument checking.
- Therefore, too many bugs in MPI applications remain undetected at compile-time, such as:
 - Missing `ierror` as last argument in most Fortran bindings.
 - Declaration of a `status` as an `INTEGER` variable instead of an `INTEGER` array with size `MPI_STATUS_SIZE`.
 - Wrong argument positions; e.g., interchanging the `count` and `datatype` arguments.
 - Passing wrong MPI handles; e.g., passing a `datatype` instead of a communicator.
- The migration from `mpif.h` to the `mpi` module should be relatively straightforward (i.e., substituting `include 'mpif.h'` after an `implicit` statement by `use mpi` before such `implicit` statement) as long as the application syntax is correct.
- Migrating portable and correctly written applications to the `mpi` module is not expected to be difficult. No compile or runtime problems should occur because an `mpif.h` include file was always allowed to provide explicit Fortran interfaces.

(*End of advice to users.*)

Rationale. With MPI-3.0, the `mpif.h` include file was not deprecated in order to retain strong backward compatibility. Internally, `mpif.h` and the `mpi` module may be implemented so that the same (or similar) library implementation of the MPI routines can be used. (*End of rationale.*)

Advice to implementors. To make `mpif.h` compatible with both fixed- and free-source forms, to allow automatic inclusion by preprocessors, and to allow extended fixed-form line length, it is recommended that [requirement two]the requirement of usability in free and fixed source form applications be met by constructing `mpif.h` without any continuation lines. This should be possible because `mpif.h` [contains]may contain only declarations, and because common block declarations can be split among several lines. The argument names may need to be shortened to keep the `SUBROUTINE` statement within the allowed 72-6=66 characters, e.g.,

```
INTERFACE
SUBROUTINE PMPI_DIST_GRAPH_CREATE_ADJACENT(a,b,c,d,e,f,g,h,i,j,k)
... ! dummy argument declarations
```

This line has [65]65 characters and is the longest in MPI-3.0. [

TODO: This is only checked for MPI-2.2. We have to check all new MPI-3.0 interfaces that they stay within these 66 characters. Otherwise the routine name should be shortened before the name is standardized.]

[If `mpif.h` contains also explicit interfaces with `BIND(C,NAME='...')` for providing `MPI_SUBARRAYS_SUPPORTED` and `MPI_ASYNC_PROTECTS_NONBLOCKING` equals `.TRUE.`, the linker routine name may need to be shortened.]As long as the MPI standard contains routines with choice buffers and a name length and argument count that implies that a `BIND(C)` implementation would need to shorten their linker names in `mpif.h`, the `mpif.h` cannot set `MPI_SUBARRAYS_SUPPORTED` and `MPI_ASYNC_PROTECTS_NONBLOCKING` equals `.TRUE.`, because such shortening is invalid. For example, `MPI_FILE_WRITE_AT_ALL_BEGIN` with 6 arguments, may be defined:

```
INTERFACE MPI_FILE_WRITE_AT_ALL_BEGIN
SUBROUTINE MPI_X(a,b,c,d,e,f)BIND(C,NAME='MPI_File_write_at_all_begin_f')
... ! dummy argument declarations
```

This would need a line length of 73 characters, i.e., the C routine name [must]would need to be shortened by 7 characters to stay within the available 66 characters. [TODO: Do we want to define these shortened routine names for `mpif.h`; this would help the tools people.]Note that the name `MPI_X` has no meaning for the compilation, and that this problem occurs only with routines with choice buffers implemented with the assumed-type and assumed-rank facility of TR 29113. To support Fortran 77 as well as Fortran 90 and later, it may be necessary to eliminate all comments from `mpif.h`. (*End of advice to implementors.*)

16.2.5 Interface Specifications, Linker Names and the Profiling Interface

The Fortran interface specifications of each MPI routine specifies the routine name that must be called by the application program, and the names and types of the dummy arguments together with additional attributes. The rules for the linker names and its implications for the profiling interface are specified within this section. The linker name of a Fortran routine is defined as the name that a C routine would have if both routines would have the same name visible for the linker. A typical linker name of the Fortran routine `FOOfoo` is `foofoo__`. In the case of `BIND(C,NAME='...')`, the linker name is directly defined through the given string.

The following rules for linker names apply:

- With the Fortran `mpi_f08` module, if `MPI_SUBARRAYS_SUPPORTED` equals `.TRUE.`:

The Fortran binding must use `BIND(C)` interfaces with an interface name identical to the language independent name, e.g., `MPI_SEND`. The linker name is a combination of the C name and an `_f08` suffix, e.g., `MPI_Send_f08`. Prototype example:

```
INTERFACE
  SUBROUTINE MPI_Send(...) BIND(C,NAME='MPI_Send_f08')
```

- With the Fortran `mpi_f08` module, if `MPI_SUBARRAYS_SUPPORTED` equals `.FALSE.` (i.e., with a preliminary implementation of this module without TR 29113):

The linker name of each routine is defined through the linker name mapping of the Fortran compiler for the name defined when subarrays are supported. For example, `MPI_Send_f08` may be mapped to `mpi_send_f08__`. Example:

```
INTERFACE MPI_Send
  SUBROUTINE MPI_Send_f08(...)
```

- With the Fortran `mpi` module or `mpif.h` include file, if `MPI_SUBARRAYS_SUPPORTED` equals `.FALSE.`:

The linker name of each routine is defined through the linker-name mapping of the Fortran compiler. For example, `MPI_SEND` may be mapped to `mpi_send__`. Example:

```
INTERFACE
  SUBROUTINE MPI_SEND(...)
```

- With the Fortran `mpi` module or `mpif.h` include file, if `MPI_SUBARRAYS_SUPPORTED` equals `.TRUE.`:

The Fortran binding must use `BIND(C)` interfaces with an interface name identical to the language independent name, e.g., `MPI_SEND`. The linker name is a combination of the C name and an `_f` suffix, e.g., `MPI_Send_f`. Prototype example:

```
INTERFACE
  SUBROUTINE MPI_SEND(...) BIND(C,NAME='MPI_Send_f')
```

If the support of subarrays is different for the `mpi` module and the `mpif.h` include file, then both linker-name methods can be used in the same application. If the application also uses the `mpi_f08` module and was compiled with this module partially before and after the subarrays were supported, then all four interfaces are used within the same application.

Rationale. After a compiler provides the facilities from TR29113, i.e., `TYPE(*)`, `DIMENSION(...)`, it is possible to change the bindings within a Fortran support method

to support subarrays and without recompiling the complete application. Of course, only recompiled routines can benefit from the added facilities. There is no binary compatibility conflict because each interface uses its own linker names and all interfaces use the same constants and type definitions. (*End of rationale.*)

A user-written or middleware profiling routine that is written according to the same binding rules will have the same linker name, and therefore, can interpose itself as the MPI library routine. The profiling routine can internally call the matching PMPI routine with any of its existing bindings, except for routines that have callback routine dummy arguments. In this case, the profiling software must use the same Fortran support method as used in the calling application program, because the C, `mpi_f08` and `mpi` callback prototypes are different.

Advice to users. This advice is mainly for tool writers. Even if an MPI library supports subarrays in all three Fortran support methods, a portable profiling layer should also provide the two interfaces for `MPI_SUBARRAYS_SUPPORTED==.FALSE.` to support older binary user routines that were compiled before TR29113 level support was achieved.

If a user application calls `MPI_SEND`, then the chosen Fortran support method together with the MPI implement decision about `MPI_SUBARRAYS_SUPPORTED` imply, to which linker name the compiler will translate this call, i.e., whether the application calls `mpi_send__`, or `MPI_Send_f`, or `mpi_send_f08__`, or `MPI_Send_f08`. If the profiling layer wants to be independent of the decision of the user program and MPI implementation, then it should provide all four routines. For example:

```

SUBROUTINE MPI_SEND(...) BIND(C,NAME='MPI_Send_f')
  USE mpi
  CALL PMPI_SEND(...)
END SUBROUTINE

```

The MPI library must provide the `PMPI_SEND` routine according to the same rules as for providing the `MPI_SEND` routine. (*End of advice to users.*)

Advice to implementors. If an implementation provides in a first step two sets of routines, one for the `mpi` module and `mpif.h`, and the other for the `mpi_f08` module, and both sets without TR 29113, i.e., `MPI_SUBARRAYS_SUPPORTED` equals `.FALSE.`, [If]and the implementor wants to add a TR 29113 based set of routines, then it is not necessary to add two full sets of routines. For full quality, it is enough to implement in each set only those routines that have a choice buffer argument. (*End of advice to implementors.*)

In the case that a Fortran binding consists of multiple routines through function overloading, the base names of overloaded routines are appended by a suffix notifying the difference in the argument list. For example, `MPI_ALLOC_MEM` (in the `mpi` module and `mpif.h`) has an `INTEGER(KIND=...)` `baseptr` argument without a suffix. This routine is overloaded by a routine with `TYPE(C_PTR)` `baseptr` and the suffix `_CPTR`. The implied linker name base is `MPI_ALLOC_MEM_CPTR`. It is mapped to the linker names `MPI_Alloc_mem_cptr_f`, and, e.g., `mpi_alloc_mem_cptr__`. Note that these routines are always called via the interface name `MPI_ALLOC_MEM` by the application within all Fortran support methods.

1
2
3
4
5
6
7
8
9
10
11
12
13
14
15
16
17
18
19
20
21
22
23
24
25
26
27
28
29
30
31
32
33
34
35
36 ticket229.2.
37
38
39
40
41
42
43
44
45
46
47
48 ticket229.2.

1 For routines without `ASYNCHRONOUS` choice buffers and that are not predefined callback
 2 routines, the implementor can freely choose to implement the routines according to the rules
 3 for `MPI_SUBARRAYS_SUPPORTED` equals `.TRUE.` or `.FALSE.`, provided that the following
 4 rule about routine grouping is fulfilled. The implementation of routines with `ASYNCHRONOUS`
 5 choice buffers depends on the rules for the provided Fortran support method and language
 6 level of the underlying compiler. Predefined callback routines for the `mpi_f08` module
 7 must be implemented with `BIND(C)` interfaces, and for the `mpi` module and `mpif.h` without
 8 `BIND(C)`.

9 Similar MPI routines are grouped together for linker symbol scheme classification. If
 10 the peer routine of a group is available within an MPI library with one of its possible linker
 11 names then all of the routines in this group must provided according to the same linker
 12 name scheme. If the peer routine is not available through a linker name scheme then all
 13 other routines in the group must not be available through this scheme.

14 Peer routines and their groups:

15	<code>MPI_ALLOC_MEM</code>	<code>MPI_ALLOC_MEM</code> and <code>MPI_WIN_ALLOCATE</code> .
16	<code>MPI_FREE_MEM</code>	Only this routine is in this group.
17	<code>MPI_GET_ADDRESS</code>	<code>MPI_GET_ADDRESS</code> and <code>MPI_ADDRESS</code> .
18	<code>MPI_SEND</code>	All routines with choice buffer arguments that 19 are not declared as <code>ASYNCHRONOUS</code> within the 20 <code>mpi_f08</code> module.
21	<code>MPI_ISEND</code>	All routines with choice buffer arguments 22 that are declared as <code>ASYNCHRONOUS</code> within the 23 <code>mpi_f08</code> module.
24	<code>MPI_OP_CREATE</code>	Only this routine is in this group.
25	<code>MPI_REGISTER_DATAREP</code>	Only this routine is in this group.
26	<code>MPI_COMM_KEYVAL_CREATE</code>	All other routines with callback function argu- 27 ments.
28	<code>MPI_COMM_DUP_FN</code>	All predefined callback routines.
29	<code>MPI_COMM_RANK</code>	All other MPI routines.

31 Additionally, four C preprocessor macros are available in `mpi.h` for each routine group.
 32 The name of the macros are the peer routine name written as in the list above and appended
 33 with one of the following suffixes and meanings:

34	<code>_mpi_f08_BIND_C</code>	The macro is set to 1 if the <code>BIND(C)</code> linker name with the 35 linker suffix <code>_f08</code> is available for all routines within this group 36 (e.g., <code>MPI_Send_f08</code>), otherwise it is set to 0.
37	<code>_mpi_f08_BIND_F</code>	The macro is set to 1 if the Fortran linker name with the 38 linker suffix <code>_f08</code> is available for all routines within this group 39 (e.g., <code>mpi_send_f08_</code>), otherwise it is set to 0.
40	<code>_mpi_BIND_C</code> ...	The macro is set to 1 if the <code>BIND(C)</code> linker name with the 41 linker suffix <code>_f</code> is available for all routines within this group 42 (e.g., <code>MPI_Send_f</code>), otherwise it is set to 0.
43	<code>_mpi_BIND_F</code> ...	The macro is set to 1 if the Fortran linker name without 44 a linker suffix is available for all routines within this group 45 (e.g., <code>mpi_send_</code>), otherwise it is set to 0.

46 For example
 47
 48

```

...
#define MPI_SEND_mpi_f08_BIND_C 0
#define MPI_SEND_mpi_f08_BIND_F 1
#define MPI_SEND_mpi_BIND_C 0
#define MPI_SEND_mpi_BIND_F 1

#define MPI_ISEND_mpi_f08_BIND_C 1
#define MPI_ISEND_mpi_f08_BIND_F 1
#define MPI_ISEND_mpi_BIND_C 1
#define MPI_ISEND_mpi_BIND_F 1
...
#define MPI_COMM_DUP_FN_mpi_f08_BIND_C 1
#define MPI_COMM_DUP_FN_mpi_f08_BIND_F 0
#define MPI_COMM_DUP_FN_mpi_BIND_C 0
#define MPI_COMM_DUP_FN_mpi_BIND_F 1
...

```

shows, that

- the routines in the `MPI_SEND` group are only available through their Fortran linker names (e.g., `mpi_send_f08_`, `mpi_send_`, `mpi_recv_f08_`, `mpi_recv_`, ...),
- the routines in the `MPI_ISEND` group are available with all four interfaces: the MPI library, the `mpi_f08` and `mpi` modules (that provide the TR 29113 quality), and this MPI library supports application routines that are compiled with an older MPI library version with `_BIND_C` set to 0 and `_BIND_F` set to 1.

For the predefined callbacks, there is no choice, because the interfaces must fit to the callback function prototypes which are `BIND(C)` based for `mpi_f08` and without `BIND(C)` for the `mpi` module and `mpif.h`.

Advice to implementors. If all following conditions are fulfilled (which is the case for most compilers):

- the handles in the `mpi_f08` module occupy one Fortran numerical storage unit (same as an `INTEGER` handle),
- the internal argument passing used to pass an actual `ierror` argument to a non optional `ierror` dummy argument is binary compatible to passing an actual `ierror` argument to an `ierror` dummy argument that is declared as `OPTIONAL`,
- the internal argument passing for `ASYNCHRONOUS` and non-`ASYNCHRONOUS` arguments is the same,
- the internal routine call mechanism is the same for the Fortran and the C compiler,
- the compiler does not provide TR 29113,

then for most groups, the implementor may use the same internal routine implementations for all Fortran support methods but with several different linker names. For TR 29113 quality, new routines are needed only for the routine group of `MPI_ISEND`.

Typical settings for `_mpi_f08_BIND_C` / `_mpi_f08_BIND_F` / `_mpi_BIND_C` / `_mpi_BIND_F` may be:

	Without TR 29113	Upgrade to TR 29113	Upgrade for strided data optimization	New impl. with TR 29113
<code>MPI_ALLOC_MEM_...</code>	0/1/0/1	0/1/0/1	0/1/0/1	1/0/1/0
<code>MPI_FREE_MEM_...</code>	0/1/0/1	0/1/0/1	0/1/0/1	1/0/1/0
<code>MPI_GET_ADDRESS_...</code>	0/1/0/1	0/1/0/1	0/1/0/1	1/0/1/0
<code>MPI_SEND_...</code>	0/1/0/1	0/1/0/1	1/1/1/1	1/0/1/0
<code>MPI_ISEND_...</code>	0/1/0/1	1/1/1/1	1/1/1/1	1/0/1/0
<code>MPI_OP_CREATE_...</code>	0/1/0/1	0/1/0/1	0/1/0/1	1/0/1/0
<code>MPI_REGISTER_DATAREP_...</code>	0/1/0/1	0/1/0/1	0/1/0/1	1/0/1/0
<code>MPI_COMM_KEYVAL_CREATE_...</code>	0/1/0/1	0/1/0/1	0/1/0/1	1/0/1/0
<code>MPI_COMM_DUP_FN_...</code>	1/0/0/1	1/0/0/1	1/0/0/1	1/0/0/1
<code>MPI_COMM_RANK_...</code>	0/1/0/1	0/1/0/1	0/1/0/1	1/0/1/0

(End of advice to implementors.)

16.2.6 MPI for Different Fortran Standard Versions

This section describes which Fortran interface functionality can be provided for different versions of the Fortran standard.

- For Fortran 77 with some extensions:

- MPI identifiers are limited to thirty or more, not six, significant characters.
- MPI identifiers may contain underscores after the first character.
- An MPI subroutine with a choice argument may be called with different argument types.
- Although not required by the MPI standard, the `INCLUDE` statement should be available for including `mpif.h` into the user application source code.

Only MPI-1.1, MPI-1.2, and MPI-1.3 can be implemented. The use of absolute addresses from `MPI_ADDRESS` and `MPI_BOTTOM` may cause problems if an address does not fit into the memory space provided by an `INTEGER`. (In MPI-2.0 this problem is solved with `MPI_GET_ADDRESS`, but not for Fortran 77.)

- For Fortran 90:

The major additional features that are needed from Fortran 90 are:

- The `MODULE` and `INTERFACE` concept.
- The `KIND=` and `SELECTED_..._KIND` concept.
- Fortran derived `TYPE`s and the `SEQUENCE` attribute.
- The `OPTIONAL` attribute for dummy arguments.
- Cray pointers, which are a non-standard compiler extension, are needed for the use of `MPI_ALLOC_MEM`.

With these features, MPI-1.1 - MPI-2.2 can be implemented without restrictions. MPI-3.0 can be implemented with some restrictions. The Fortran support methods are abbreviated with S1 = the `mpi_f08` module, S2 = the `mpi` module, and S3 = the `mpif.f` include file. If not stated otherwise, restrictions exist for each method which prevent implementing the complete semantics of MPI-3.0.

- MPI_SUBARRAYS_SUPPORTED equals `.FALSE.`, i.e., subscript triplets and non-contiguous subarrays cannot be used as buffers in nonblocking routines, RMA, or split-collective I/O.
- S1, S2, and S3 can be implemented, but for S1, only a preliminary implementation is possible.
- In this preliminary interface of S1, the following changes are necessary:
 - * The routines are not `BIND(C)`.
 - * `TYPE(*)`, `DIMENSION(..)` is substituted by non-standardized extensions like `!$PRAGMA IGNORE_TKR`.
 - * The `ASYNCHRONOUS` attribute is omitted.
 - * `PROCEDURE(...)` callback declarations are substituted by `EXTERNAL`.
- The linker names are specified in Section 16.2.5 on page 653.
- Due to the rules specified in Section 16.2.5 on page 653, choice buffer declarations should be implemented only with non-standardized extensions like `!$PRAGMA IGNORE_TKR` (as long as F2008+TR29113 is not available).
 In S2 and S3: Without such extensions, routines with choice buffers should be provided with an implicit interface, instead of overloading with a different MPI function for each possible buffer type (as mentioned in Section 16.2.11 on page 674). Such overloading would also imply restrictions for passing Fortran derived types as choice buffer, see also Section 16.2.15 on page 679.
 Only in S1: The implicit interfaces for routines with choice buffer arguments imply that the `ierror` argument cannot be defined as `OPTIONAL`. For this reason, it is recommended not to provide the `mpi_f08` module if such an extension is not available.
- The `ASYNCHRONOUS` attribute can **not** be used in applications to protect buffers in nonblocking MPI calls (S1-S3).
- The `TYPE(C_PTR)` binding of the `MPI_ALLOC_MEM` and `MPI_WIN_ALLOCATE` routines is not available.
- In S1 and S2, the definition of the handle types (e.g., `TYPE(MPI_Comm)` and the status type `TYPE(MPI_Status)` must be modified: The `SEQUENCE` attribute must be used instead of `BIND(C)` (which is not available in Fortran 90/95). This restriction implies that the application must be fully recompiled if one switches to an MPI library for Fortran 2003 and later because the internal memory size of the handles may have changed. For this reason, an implementor may choose not to provide the `mpi_f08` module for Fortran 90 compilers. In this case, the `mpi_f08` handle types and all routines, constants and types related to `TYPE(MPI_Status)` (see Section 16.3.5 on page 700) are also not available in the `mpi` module and `mpif.h`.

- 1 • For Fortran 95:
- 2 The quality of the MPI interface and the restrictions are the same as with Fortran 90.
- 3
- 4 • For Fortran 2003:
- 5 The major features that are needed from Fortran 2003 are:

- 6 – Interoperability with C, i.e.,
- 7 * `BIND(C, NAME='...')` interfaces.
- 8 * `BIND(C)` derived types.
- 9 * The `ISO_C_BINDING` intrinsic type `C_PTR` and routine `C_F_POINTER`.
- 10
- 11 – The ability to define an `ABSTRACT INTERFACE` and to use it for `PROCEDURE` dummy
- 12 arguments.
- 13
- 14 – The `ASYNCHRONOUS` attribute is available to protect Fortran asynchronous I/O.
- 15 This feature is not yet used by MPI, but it is the basis for the enhancement for
- 16 MPI communication in the TR 29113.

17 With these features (but still without the features of TR29113), MPI-1.1 - MPI-2.2

18 can be implemented without restrictions, but with one enhancement:

- 19 – The user application can use `TYPE(C_PTR)` together with `MPI_ALLOC_MEM` as
- 20 long as `MPI_ALLOC_MEM` is defined with an implicit interface because a `C_PTR`
- 21 and an `INTEGER(KIND=MPI_ADDRESS_KIND)` argument must both map to a `void`
- 22 * argument.
- 23

24 MPI-3.0 can be implemented with the following restrictions:

- 25 – `MPI_SUBARRAYS_SUPPORTED` equals `.FALSE..`
 - 26
 - 27 – For `S1`, only a preliminary implementation is possible. The following changes are
 - 28 necessary:
 - 29 * The routines are not `BIND(C)`.
 - 30 * `TYPE(*)`, `DIMENSION(..)` is substituted by non-standardized extensions
 - 31 like `!$PRAGMA IGNORE_TKR`.
 - 32
 - 33 – The linker names are specified in Section 16.2.5 on page 653.
 - 34
 - 35 – With `S1`, the `ASYNCHRONOUS` is required as specified in the second Fortran inter-
 - 36 faces. With `S2` and `S3` the implementation can also add this attribute if explicit
 - 37 interfaces are used.
 - 38
 - 39 – The `ASYNCHRONOUS` Fortran attribute can be used in applications to **try to** pro-
 - 40 tect buffers in nonblocking MPI calls, but the protection can work only if the
 - 41 compiler is able to protect asynchronous Fortran I/O and makes no difference
 - 42 between such asynchronous Fortran I/O and MPI communication.
 - 43
 - 44 – The `TYPE(C_PTR)` binding of the `MPI_ALLOC_MEM` and `MPI_WIN_ALLOCATE`
 - 45 routines can be used only for Fortran types that are C compatible.
 - 46
 - 47 – The same restriction as for Fortran 90 applies if non-standardized extensions like
 - 48 `!$PRAGMA IGNORE_TKR` are not available.
- 46 • For Fortran 2008 + TR 29113 and later and
 - 47 For Fortran 2003 + TR 29113:
 - 48 The major feature that are needed from TR29113 are:

- TYPE(*), DIMENSION(..) is available.
- The ASYNCHRONOUS attribute is extended to protect also nonblocking MPI communication.
- OPTIONAL dummy arguments are allowed in combination with BIND(C) interfaces.
- CHARACTER(LEN=*) dummy arguments are allowed in combination with BIND(C) interfaces.
- The array dummy argument of the ISO_C_BINDING intrinsic C_F_POINTER is not restricted to Fortran types for which a corresponding type in C exists.

Using these features, MPI-3.0 can be implemented without any restrictions.

- With S1, MPI_SUBARRAYS_SUPPORTED equals .TRUE.. The ASYNCHRONOUS attribute can be used to protect buffers in nonblocking MPI calls. The TYPE(C_PTR) binding of the MPI_ALLOC_MEM and MPI_WIN_ALLOCATE routines can be used for any Fortran type.
- With S2 and S3, the value of MPI_SUBARRAYS_SUPPORTED is implementation dependent. A high quality implementation will also provide MPI_SUBARRAYS_SUPPORTED==.TRUE. and will use the ASYNCHRONOUS attribute in the same way as in S1.
- If non-standardized extensions like !\$PRAGMA IGNORE_TKR are not available then S2 must be implemented with TYPE(*), DIMENSION(..).

Advice to implementors. If MPI_SUBARRAYS_SUPPORTED==.FALSE., the choice argument may be implemented with an explicit interface using compiler directives, for example:

```

INTERFACE
  SUBROUTINE MPI...(buf, ...)
    !DEC$ ATTRIBUTES NO_ARG_CHECK :: buf
    !$PRAGMA IGNORE_TKR buf
    !DIR$ IGNORE_TKR buf
    !IBM* IGNORE_TKR buf
    REAL, DIMENSION(*) :: buf
    ... ! declarations of the other arguments
  END SUBROUTINE
END INTERFACE

```

(End of advice to implementors.)

16.2.7 Requirements on Fortran Compilers

MPI-3.0 (and later) compliant Fortran bindings are not only a property of the MPI library itself, but rather a property of an MPI library together with the Fortran compiler suite for which it is compiled.

Advice to users. Users must take appropriate steps to ensure that proper options are specified to compilers. MPI libraries must document these options. Some MPI libraries are shipped together with special compilation scripts (e.g., mpif90, mpicc) that set these options automatically. *(End of advice to users.)*

1 An MPI library together with the Fortran compiler suite is only compliant with MPI-3.0 (and
 2 later), as referred by `MPI_GET_VERSION`, if all the solutions described in Sections 16.2.11
 3 through 16.2.19 work correctly. Based on this rule, major requirements for all three Fortran
 ticket234-F. 4 support methods (i.e., the `mpi_f08` and `mpi` modules, and `mpif.h`) are:

- 5 • The language features assumed-type and assumed-rank from Fortran 2008 TR 29113
 6 [41] are available. This is required only for `mpi_f08`. As long as this requirement is not
 ticket229.1. 7 supported by the compiler, it is valid to build [a preliminary MPI-3.0 (and not later)]an
 8 MPI library that implements the `mpi_f08` module with `MPI_SUBARRAYS_SUPPORTED`
 9 set to `.FALSE..`

- 10 ticket230-B. 11 • ‘Simply contiguous’ arrays and scalars must be passed to choice buffer dummy argu-
 12 ments of nonblocking routines with call by reference. This is needed only if one of the
 13 support methods does not use the `ASYNCHRONOUS` attribute. See Section 16.2.12 on
 ticket237-I. 14 page 675 for more details.

- 15 • `SEQUENCE` and `BIND(C)` derived types are valid as actual arguments passed to choice
 16 buffer dummy arguments, and, in the case of `MPI_SUBARRAYS_SUPPORTED==`
 17 `.FALSE..`, they are passed with call by reference, and passed by descriptor in the case
 18 of `.TRUE..`

- 19 ticket232-D. 20 • All actual arguments that are allowed for a dummy argument in an implicitly defined
 21 and separately compiled Fortran routine with the given compiler (e.g.,
 22 `CHARACTER(LEN=*)` strings and array of strings) must also be valid for choice buffer
 23 dummy arguments with all Fortran support methods.

- 24 ticket246-Q. 25 • The array dummy argument of the `ISO_C_BINDING` intrinsic module procedure
 26 `C_F_POINTER` is not restricted to Fortran types for which a corresponding type in C
 27 exists.

- 28 ticket238-J. 29 • The Fortran compiler shall not provide `TYPE(*)` unless the `ASYNCHRONOUS` attribute
 30 protects MPI communication as described in TR 29113. Specifically, the TR 29113
 31 must be implemented as a whole.

32 ticket238-J. 33 The following rules are required at least as long as the compiler does not provide the exten-
 34 sion of the `ASYNCHRONOUS` attribute as part of TR 29113 and there is still one Fortran support
 ticket229.1. 35 method with `MPI_ASYNC_PROTECTS_NONBLOCKING==.FALSE..` It is helpful when these
 36 rules are observed, especially for backward compatibility of existing applications that use
 ticket238-J. 37 the `mpi` module or the `mpif.h` include file. The rules are as follows:

- 38 • Separately compiled empty Fortran routines with implicit interfaces and separately
 39 compiled empty C routines with `BIND(C)` Fortran interfaces (e.g., `MPI_F_SYNC_REG`
 40 on page 687 and Section 16.2.8 on page 663, and `DD` on page 688) solve the problems
 41 described in Section 16.2.17 on page 682.

- 42 ticket238-J. 43 • The problems with temporary data movement (described in detail in Section 16.2.18
 44 on page 690) are solved as long as the application uses different sets of variables
 45 for the nonblocking communication (or nonblocking or split collective IO) and the
 46 computation when overlapping communication and computation.

- Problems caused by automatic and permanent data movement (e.g., within a garbage collection, see Section 16.2.19 on page 692) are resolved **without** any further requirements on the application program, neither on the usage of the buffers, nor on the declaration of application routines that are involved in calling MPI operations.

All of these rules are valid independently of whether the MPI routine interfaces in the `mpi_f08` and `mpi` modules are internally defined with an `INTERFACE` or `CONTAINS` construct, and with or without `BIND(C)`, and also when `mpif.h` uses explicit interfaces.

Advice to implementors. Some of these rules are already part of the Fortran 2003 standard if the MPI interfaces are defined without `BIND(C)`. Additional compiler support may be necessary if `BIND(C)` is used. Some of these additional requirements are defined in the Fortran 2008 TR 29113 [41]. Some of these requirements for MPI-3.0 are beyond the scope of TR 29113. (*End of advice to implementors.*)

Further requirements apply when the MPI library internally uses `BIND(C)` routine interfaces (i.e., for a full implementation of `mpi_f08`):

- Non-buffer arguments are `INTEGER`, `INTEGER(KIND=...)`, `CHARACTER(LEN=*)`, `LOGICAL`, and `BIND(C)` derived types, (handles and status in `mpi_f08`) variables and arrays; function results are `DOUBLE PRECISION`. All these types must be valid as dummy arguments in the `BIND(C)` MPI routine interfaces. When compiling an MPI application, the compiler should not issue warnings indicating that these types may not be interoperable with an existing type in C. Some of these types are already valid in `BIND(C)` interfaces since Fortran 2003, some may be valid based on TR 29113 (e.g., `CHARACTER*(*)`).
- `OPTIONAL` dummy arguments are also valid within `BIND(C)` interfaces. This requirement is fulfilled if TR 29113 is fully supported by the compiler.

16.2.8 Additional Support for Fortran Register-Memory-Synchronization

As described in Section 16.2.17 on page 682, a dummy call may be necessary to tell the compiler that registers are to be flushed for a given buffer or that accesses to a buffer may not be moved across a given point in the execution sequence. Only a Fortran binding exists for this call.

`MPI_F_SYNC_REG(buf)`

`INOUT` `buf` initial address of buffer (choice)

`MPI_F_sync_reg(buf) BIND(C)`

`TYPE(*)`, `DIMENSION(..)`, `ASYNCHRONOUS` `::` `buf`

`MPI_F_SYNC_REG(buf)`

`<type>` `buf(*)`

This routine is a no-operation. It must be compiled in the MPI library in such a manner that a Fortran compiler cannot detect in the module that the routine has an empty body. It is used only to force the compiler to flush a cached register value of a variable or buffer back to memory (when necessary), or to invalidate the register value.

1
2
3
4
5 ticket230-B.
6
7
8
9
10
11
12
13
14
15
16 ticket230-B.
17
18
19 ticket231-C.
20 ticket230-B.
21
22
23
24
25 ticket239-K.
26
27
28
29
30 ticket238-J.
31 ticket238-J.
32
33
34
35
36
37
38
39 ticket-248T.
40
41
42
43
44
45
46
47
48

1 *Rationale.* This function is not available in other languages because it would not be
 2 useful. This routine has no `ierror` return argument because there is no operation that
 3 can fail. (*End of rationale.*)

4
 5 *Advice to implementors.* This routine can be bound to a C routine to minimize
 6 the risk that the Fortran compiler can learn that this routine is empty (and that
 7 the call to this routine can be removed as part of an optimization). However, it is
 8 explicitly allowed to implement this routine within the `mpi_f08` module according to
 9 the definition for the `mpi` module or `mpif.h` to circumvent the overhead of building
 10 the internal dope vector to handle the assumed-type, assumed-rank argument. (*End*
 11 *of advice to implementors.*)

12
 13 *Rationale.* This routine is not defined with `TYPE(*)`, `DIMENSION(*)`, i.e., assumed
 ticket229.1. 14 size instead of assumed rank, because this would restrict the usability to ‘simply
 15 contiguous’ arrays and would require overloading with another interface for scalar
 16 arguments. (*End of rationale.*)

17
 18 *Advice to users.* If only a part of an array (e.g., defined by a subscript triplet) is
 19 used in a nonblocking routine, it is recommended to pass the whole array to
 20 `MPI_F_SYNC_REG` anyway to minimize the overhead of this no-operation call. Note
 ticket229.1. 21 that this routine need not to be called if `MPI_ASYNC_PROTECTS_NONBLOCKING` is
 22 `.TRUE.` and the application fully uses the facilities of `ASYNCHRONOUS` arrays. (*End of*
 23 *advice to users.*)

16.2.9 Additional Support for Fortran Numeric Intrinsic Types

ticket230-B. 24
 25
 26 [The routines in this section are part of Extended Fortran Support described in Sec-
 27 tion 16.2.3.]

28
 29 MPI provides a small number of named datatypes that correspond to named intrinsic
 30 types supported by C and Fortran. These include `MPI_INTEGER`, `MPI_REAL`, `MPI_INT`,
 31 `MPI_DOUBLE`, etc., as well as the optional types `MPI_REAL4`, `MPI_REAL8`, etc. There is a
 32 one-to-one correspondence between language declarations and MPI types.

33 Fortran (starting with Fortran 90) provides so-called `KIND`-parameterized types. These
 34 types are declared using an intrinsic type (one of `INTEGER`, `REAL`, `COMPLEX`, `LOGICAL` and
 35 `CHARACTER`) with an optional integer `KIND` parameter that selects from among one or more
 36 variants. The specific meaning of different `KIND` values themselves are implementation
 37 dependent and not specified by the language. Fortran provides the `KIND` selection functions
 38 `selected_real_kind` for `REAL` and `COMPLEX` types, and `selected_int_kind` for `INTEGER`
 39 types that allow users to declare variables with a minimum precision or number of digits.
 40 These functions provide a portable way to declare `KIND`-parameterized `REAL`, `COMPLEX` and
 41 `INTEGER` variables in Fortran. This scheme is backward compatible with Fortran 77. `REAL`
 42 and `INTEGER` Fortran variables have a default `KIND` if none is specified. Fortran `DOUBLE`
 43 `PRECISION` variables are of intrinsic type `REAL` with a non-default `KIND`. The following two
 44 declarations are equivalent:

```
45
46     double precision x
47     real(KIND(0.0d0)) x
48
```

MPI provides two orthogonal methods to communicate using numeric intrinsic types. The first method (see the following section) can be used when variables have been declared in a portable way — using default KIND or using KIND parameters obtained with the `selected_int_kind` or `selected_real_kind` functions. With this method, MPI automatically selects the correct data size (e.g., 4 or 8 bytes) and provides representation conversion in heterogeneous environments. The second method (see Support for size-specific MPI Datatypes on page 669) gives the user complete control over communication by exposing machine representations.

Parameterized Datatypes with Specified Precision and Exponent Range

MPI provides named datatypes corresponding to standard Fortran 77 numeric types — `MPI_INTEGER`, `MPI_COMPLEX`, `MPI_REAL`, `MPI_DOUBLE_PRECISION` and `MPI_DOUBLE_COMPLEX`. MPI automatically selects the correct data size and provides representation conversion in heterogeneous environments. The mechanism described in this section extends this model to support portable parameterized numeric types.

The model for supporting portable parameterized types is as follows. Real variables are declared (perhaps indirectly) using `selected_real_kind(p, r)` to determine the KIND parameter, where `p` is decimal digits of precision and `r` is an exponent range. Implicitly MPI maintains a two-dimensional array of predefined MPI datatypes `D(p, r)`. `D(p, r)` is defined for each value of `(p, r)` supported by the compiler, including pairs for which one value is unspecified. Attempting to access an element of the array with an index `(p, r)` not supported by the compiler is erroneous. MPI implicitly maintains a similar array of `COMPLEX` datatypes. For integers, there is a similar implicit array related to `selected_int_kind` and indexed by the requested number of digits `r`. Note that the predefined datatypes contained in these implicit arrays are not the same as the named MPI datatypes `MPI_REAL`, etc., but a new set.

Advice to implementors. The above description is for explanatory purposes only. It is not expected that implementations will have such internal arrays. (*End of advice to implementors.*)

Advice to users. `selected_real_kind()` maps a large number of `(p,r)` pairs to a much smaller number of KIND parameters supported by the compiler. KIND parameters are not specified by the language and are not portable. From the language point of view intrinsic types of the same base type and KIND parameter are of the same type. In order to allow interoperability in a heterogeneous environment, MPI is more stringent. The corresponding MPI datatypes match if and only if they have the same `(p,r)` value (`REAL` and `COMPLEX`) or `r` value (`INTEGER`). Thus MPI has many more datatypes than there are fundamental language types. (*End of advice to users.*)

```

1 MPI_TYPE_CREATE_F90_REAL(p, r, newtype)
2     IN      p                precision, in decimal digits (integer)
3     IN      r                decimal exponent range (integer)
4     OUT     newtype          the requested MPI datatype (handle)
5
6
7 int MPI_Type_create_f90_real(int p, int r, MPI_Datatype *newtype)

```

```

8 MPI_Type_create_f90_real(p, r, newtype, ierror) BIND(C)
9     INTEGER, INTENT(IN) :: p, r
10    TYPE(MPI_Datatype), INTENT(OUT) :: newtype
11    INTEGER, OPTIONAL, INTENT(OUT) :: ierror
12
13

```

```

14 MPI_TYPE_CREATE_F90_REAL(P, R, NEWTYPE, IERROR)
15     INTEGER P, R, NEWTYPE, IERROR
16

```

```

17 {static MPI::Datatype MPI::Datatype::Create_f90_real(int p, int r) (binding
18     deprecated, see Section 15.2) }
19

```

This function returns a predefined MPI datatype that matches a `REAL` variable of `KIND selected_real_kind(p, r)`. In the model described above it returns a handle for the element `D(p, r)`. Either `p` or `r` may be omitted from calls to `selected_real_kind(p, r)` (but not both). Analogously, either `p` or `r` may be set to `MPI_UNDEFINED`. In communication, an MPI datatype `A` returned by `MPI_TYPE_CREATE_F90_REAL` matches a datatype `B` if and only if `B` was returned by `MPI_TYPE_CREATE_F90_REAL` called with the same values for `p` and `r` or `B` is a duplicate of such a datatype. Restrictions on using the returned datatype with the “external32” data representation are given on page 668.

It is erroneous to supply values for `p` and `r` not supported by the compiler.

```

29 MPI_TYPE_CREATE_F90_COMPLEX(p, r, newtype)
30     IN      p                precision, in decimal digits (integer)
31     IN      r                decimal exponent range (integer)
32     OUT     newtype          the requested MPI datatype (handle)
33
34

```

```

35 int MPI_Type_create_f90_complex(int p, int r, MPI_Datatype *newtype)

```

```

36 MPI_Type_create_f90_complex(p, r, newtype, ierror) BIND(C)
37     INTEGER, INTENT(IN) :: p, r
38     TYPE(MPI_Datatype), INTENT(OUT) :: newtype
39     INTEGER, OPTIONAL, INTENT(OUT) :: ierror
40
41

```

```

42 MPI_TYPE_CREATE_F90_COMPLEX(P, R, NEWTYPE, IERROR)
43     INTEGER P, R, NEWTYPE, IERROR
44

```

```

45 {static MPI::Datatype MPI::Datatype::Create_f90_complex(int p,
46     int r) (binding deprecated, see Section 15.2) }
47

```

This function returns a predefined MPI datatype that matches a `COMPLEX` variable of `KIND selected_real_kind(p, r)`. Either `p` or `r` may be omitted from

calls to `selected_real_kind(p, r)` (but not both). Analogously, either `p` or `r` may be set to `MPI_UNDEFINED`. Matching rules for datatypes created by this function are analogous to the matching rules for datatypes created by `MPI_TYPE_CREATE_F90_REAL`. Restrictions on using the returned datatype with the “external32” data representation are given on page 668.

It is erroneous to supply values for `p` and `r` not supported by the compiler.

`MPI_TYPE_CREATE_F90_INTEGER(r, newtype)`

IN	<code>r</code>	decimal exponent range, i.e., number of decimal digits (integer)
OUT	<code>newtype</code>	the requested MPI datatype (handle)

`int MPI_Type_create_f90_integer(int r, MPI_Datatype *newtype)`

```
MPI_Type_create_f90_integer(r, newtype, ierror) BIND(C)
  INTEGER, INTENT(IN) :: r
  TYPE(MPI_Datatype), INTENT(OUT) :: newtype
  INTEGER, OPTIONAL, INTENT(OUT) :: ierror
```

```
MPI_TYPE_CREATE_F90_INTEGER(R, NEWTYPE, IERROR)
  INTEGER R, NEWTYPE, IERROR
```

```
{static MPI::Datatype MPI::Datatype::Create_f90_integer(int r) (binding
  deprecated, see Section 15.2) }
```

This function returns a predefined MPI datatype that matches a `INTEGER` variable of `KIND selected_int_kind(r)`. Matching rules for datatypes created by this function are analogous to the matching rules for datatypes created by `MPI_TYPE_CREATE_F90_REAL`. Restrictions on using the returned datatype with the “external32” data representation are given on page 668.

It is erroneous to supply a value for `r` that is not supported by the compiler.

Example:

```
integer      longtype, quadtype
integer, parameter :: long = selected_int_kind(15)
integer(long) ii(10)
real(selected_real_kind(30)) x(10)
call MPI_TYPE_CREATE_F90_INTEGER(15, longtype, ierror)
call MPI_TYPE_CREATE_F90_REAL(30, MPI_UNDEFINED, quadtype, ierror)
...

call MPI_SEND(ii, 10, longtype, ...)
call MPI_SEND(x, 10, quadtype, ...)
```

Advice to users. The datatypes returned by the above functions are predefined datatypes. They cannot be freed; they do not need to be committed; they can be used with predefined reduction operations. There are two situations in which they behave differently syntactically, but not semantically, from the MPI named predefined datatypes.

- 1 1. MPI_TYPE_GET_ENVELOPE returns special combiners that allow a program to
2 retrieve the values of `p` and `r`.
- 3 2. Because the datatypes are not named, they cannot be used as compile-time
4 initializers or otherwise accessed before a call to one of the
5 MPI_TYPE_CREATE_F90_XXXX routines.

6
7 If a variable was declared specifying a non-default KIND value that was not obtained
8 with `selected_real_kind()` or `selected_int_kind()`, the only way to obtain a
9 matching MPI datatype is to use the size-based mechanism described in the next
10 section.

11 (*End of advice to users.*)

12
13 *Advice to implementors.* An application may often repeat a call to
14 MPI_TYPE_CREATE_F90_XXXX with the same combination of (XXXX,p,r). The appli-
15 cation is not allowed to free the returned predefined, unnamed datatype handles. To
16 prevent the creation of a potentially huge amount of handles, a high quality MPI imple-
17 mentation should return the same datatype handle for the same (REAL/COMPLEX/
18 INTEGER,p,r) combination. Checking for the combination (p,r) in the preceding call
19 to MPI_TYPE_CREATE_F90_XXXX and using a hash[-] table to find formerly gener-
20 ated handles should limit the overhead of finding a previously generated datatype
21 with same combination of (XXXX,p,r). (*End of advice to implementors.*)

22
23 *Rationale.* The MPI_TYPE_CREATE_F90_REAL/COMPLEX/INTEGER interface
24 needs as input the original range and precision values to be able to define useful
25 and compiler-independent external (Section 13.5.2 on page 562) or user-defined (Sec-
26 tion 13.5.3 on page 563) data representations, and in order to be able to perform
27 automatic and efficient data conversions in a heterogeneous environment. (*End of*
28 *rationale.*)

29 We now specify how the datatypes described in this section behave when used with the
30 “external32” external data representation described in Section 13.5.2 on page 562.

31 The external32 representation specifies data formats for integer and floating point val-
32 ues. Integer values are represented in two’s complement big-endian format. Floating point
33 values are represented by one of three IEEE formats. These are the IEEE “Single,” “Dou-
34 ble” and “Double Extended” formats, requiring 4, 8 and 16 bytes of storage, respectively.
35 For the IEEE “Double Extended” formats, MPI specifies a Format Width of 16 bytes, with
36 15 exponent bits, bias = +10383, 112 fraction bits, and an encoding analogous to the
37 “Double” format.

38 The external32 representations of the datatypes returned by
39 MPI_TYPE_CREATE_F90_REAL/COMPLEX/INTEGER are given by the following rules.

40 For MPI_TYPE_CREATE_F90_REAL:

```
41   if      (p > 33) or (r > 4931) then  external32 representation
42                                     is undefined
43   else if (p > 15) or (r >  307) then  external32_size = 16
44   else if (p >  6) or (r >   37) then  external32_size =  8
45   else                                     external32_size =  4
```

47 For MPI_TYPE_CREATE_F90_COMPLEX: twice the size as for MPI_TYPE_CREATE_F90_REAL.

48 For MPI_TYPE_CREATE_F90_INTEGER:

```

if      (r > 38) then  external32 representation is undefined
else if (r > 18) then  external32_size = 16
else if (r >  9) then  external32_size =  8
else if (r >  4) then  external32_size =  4
else if (r >  2) then  external32_size =  2
else
                    external32_size =  1

```

If the external32 representation of a datatype is undefined, the result of using the datatype directly or indirectly (i.e., as part of another datatype or through a duplicated datatype) in operations that require the external32 representation is undefined. These operations include MPI_PACK_EXTERNAL, MPI_UNPACK_EXTERNAL and many MPI_FILE functions, when the “external32” data representation is used. The ranges for which the external32 representation is undefined are reserved for future standardization.

Support for Size-specific MPI Datatypes

MPI provides named datatypes corresponding to optional Fortran 77 numeric types that contain explicit byte lengths — MPI_REAL4, MPI_INTEGER8, etc. This section describes a mechanism that generalizes this model to support all Fortran numeric intrinsic types.

We assume that for each **typeclass** (integer, real, complex) and each word size there is a unique machine representation. For every pair (**typeclass**, **n**) supported by a compiler, MPI must provide a named size-specific datatype. The name of this datatype is of the form MPI_<TYPE>n in C and Fortran and of the form MPI::<TYPE>n in C++ where <TYPE> is one of REAL, INTEGER and COMPLEX, and **n** is the length in bytes of the machine representation. This datatype locally matches all variables of type (**typeclass**, **n**). The list of names for such types includes:

```

MPI_REAL4
MPI_REAL8
MPI_REAL16
MPI_COMPLEX8
MPI_COMPLEX16
MPI_COMPLEX32
MPI_INTEGER1
MPI_INTEGER2
MPI_INTEGER4
MPI_INTEGER8
MPI_INTEGER16

```

One datatype is required for each representation supported by the compiler. To be backward compatible with the interpretation of these types in MPI-1, we assume that the nonstandard declarations REAL*n, INTEGER*n, always create a variable whose representation is of size **n**. These datatypes may also be used for variables declared with KIND=INT8/16/32/64 or KIND=REAL32/64/128, which are defined in the ISO_FORTRAN_ENV intrinsic module. Note that the MPI datatypes and the REAL*n, INTEGER*n declarations count bytes whereas the Fortran KIND values count bits. All these datatypes are predefined.

The following functions allow a user to obtain a size-specific MPI datatype for any intrinsic Fortran type.

1 MPI_SIZEOF(x, size)

2 IN x a Fortran variable of numeric intrinsic type (choice)

3 OUT size size of machine representation of that type (integer)

4
5 ticket-248T. 6 MPI_Sizeof(x, size, ierror) BIND(C)

7 TYPE(*), DIMENSION(..) :: x

8 INTEGER, INTENT(OUT) :: size

9 INTEGER, OPTIONAL, INTENT(OUT) :: ierror

10 MPI_SIZEOF(X, SIZE, IERROR)

11 <type> X

12 INTEGER SIZE, IERROR

13
14 This function returns the size in bytes of the machine representation of the given
15 variable. It is a generic Fortran routine and has a Fortran binding only.

16
17 *Advice to users.* This function is similar to the C and C++ *sizeof* operator but
18 behaves slightly differently. If given an array argument, it returns the size of the base
19 element, not the size of the whole array. (*End of advice to users.*)

20
21 *Rationale.* This function is not available in other languages because it would not be
22 useful. (*End of rationale.*)

23
24
25 ticket252-W. MPI_TYPE_MATCH_SIZE(typeclass, size, datatype)

26 IN typeclass generic type specifier (integer)

27 IN size size, in bytes, of representation (integer)

28 OUT [ticket252-W.]datatype datatype with correct type, size (handle)

29
30
31
32 ticket252-W. int MPI_Type_match_size(int typeclass, int size, MPI_Datatype *datatype)
33 ticket-248T.

34 MPI_Type_match_size(typeclass, size, datatype, ierror) BIND(C)

35 INTEGER, INTENT(IN) :: typeclass, size

36 TYPE(MPI_Datatype), INTENT(OUT) :: datatype

37 INTEGER, OPTIONAL, INTENT(OUT) :: ierror

38 ticket252-W. MPI_TYPE_MATCH_SIZE(TYPECLASS, SIZE, DATATYPE, IERROR)

39 ticket252-W. INTEGER TYPECLASS, SIZE, DATATYPE, IERROR

40 {static MPI::Datatype MPI::Datatype::Match_size(int typeclass,
41 int size) (*binding deprecated, see Section 15.2*) }

42
43 typeclass is one of MPI_TYPECLASS_REAL, MPI_TYPECLASS_INTEGER and
44 MPI_TYPECLASS_COMPLEX, corresponding to the desired **typeclass**. The function returns
45 an MPI datatype matching a local variable of type (**typeclass**, **size**).

46 This function returns a reference (handle) to one of the predefined named datatypes, not
47 a duplicate. This type cannot be freed. MPI_TYPE_MATCH_SIZE can be used to obtain a
48 size-specific type that matches a Fortran numeric intrinsic type by first calling MPI_SIZEOF

in order to compute the variable size, and then calling `MPI_TYPE_MATCH_SIZE` to find a suitable datatype. In C and C++, one can use the C function `sizeof()`, instead of `MPI_SIZEOF`. In addition, for variables of default kind the variable's size can be computed by a call to `MPI_TYPE_GET_EXTENT`, if the `typeclass` is known. It is erroneous to specify a size not supported by the compiler.

Rationale. This is a convenience function. Without it, it can be tedious to find the correct named type. See note to implementors below. (*End of rationale.*)

Advice to implementors. This function could be implemented as a series of tests.

```
int MPI_Type_match_size(int typeclass, int size, MPI_Datatype *rtype)
{
    switch(typeclass) {
        case MPI_TYPECLASS_REAL: switch(size) {
            case 4: *rtype = MPI_REAL4; return MPI_SUCCESS;
            case 8: *rtype = MPI_REAL8; return MPI_SUCCESS;
            default: error(...);
        }
        case MPI_TYPECLASS_INTEGER: switch(size) {
            case 4: *rtype = MPI_INTEGER4; return MPI_SUCCESS;
            case 8: *rtype = MPI_INTEGER8; return MPI_SUCCESS;
            default: error(...);
        }
        ... etc. ...
    }
}
```

(*End of advice to implementors.*)

Communication With Size-specific Types

The usual type matching rules apply to size-specific datatypes: a value sent with datatype `MPI_<TYPE>n` can be received with this same datatype on another process. Most modern computers use 2's complement for integers and IEEE format for floating point. Thus, communication using these size-specific datatypes will not entail loss of precision or truncation errors.

Advice to users. Care is required when communicating in a heterogeneous environment. Consider the following code:

```
real(selected_real_kind(5)) x(100)
call MPI_SIZEOF(x, size, ierror)
call MPI_TYPE_MATCH_SIZE(MPI_TYPECLASS_REAL, size, xtype, ierror)
if (myrank .eq. 0) then
    ... initialize x ...
    call MPI_SEND(x, xtype, 100, 1, ...)
else if (myrank .eq. 1) then
    call MPI_RECV(x, xtype, 100, 0, ...)
endif
```

This may not work in a heterogeneous environment if the value of `size` is not the same on process 1 and process 0. There should be no problem in a homogeneous environment. To communicate in a heterogeneous environment, there are at least four options. The first is to declare variables of default type and use the MPI datatypes for these types, e.g., declare a variable of type `REAL` and use `MPI_REAL`. The second is to use `selected_real_kind` or `selected_int_kind` and with the functions of the previous section. The third is to declare a variable that is known to be the same size on all architectures (e.g., `selected_real_kind(12)` on almost all compilers will result in an 8-byte representation). The fourth is to carefully check representation size before communication. This may require explicit conversion to a variable of size that can be communicated and handshaking between sender and receiver to agree on a size.

Note finally that using the “external32” representation for I/O requires explicit attention to the representation sizes. Consider the following code:

```

16  real(selected_real_kind(5)) x(100)
17  call MPI_SIZEOF(x, size, ierror)
18  call MPI_TYPE_MATCH_SIZE(MPI_TYPECLASS_REAL, size, xtype, ierror)
19
20  if (myrank .eq. 0) then
21      call MPI_FILE_OPEN(MPI_COMM_SELF, 'foo',                &
22                        MPI_MODE_CREATE+MPI_MODE_WRONLY,    &
23                        MPI_INFO_NULL, fh, ierror)
24      call MPI_FILE_SET_VIEW(fh, zero, xtype, xtype, 'external32', &
25                            MPI_INFO_NULL, ierror)
26      call MPI_FILE_WRITE(fh, x, 100, xtype, status, ierror)
27      call MPI_FILE_CLOSE(fh, ierror)
28  endif
29
30  call MPI_BARRIER(MPI_COMM_WORLD, ierror)
31
32  if (myrank .eq. 1) then
33      call MPI_FILE_OPEN(MPI_COMM_SELF, 'foo', MPI_MODE_RDONLY, &
34                        MPI_INFO_NULL, fh, ierror)
35      call MPI_FILE_SET_VIEW(fh, zero, xtype, xtype, 'external32', &
36                            MPI_INFO_NULL, ierror)
37      call MPI_FILE_WRITE(fh, x, 100, xtype, status, ierror)
38      call MPI_FILE_CLOSE(fh, ierror)
39  endif
40

```

If processes 0 and 1 are on different machines, this code may not work as expected if the size is different on the two machines. (*End of advice to users.*)

16.2.10 Problems With Fortran Bindings for MPI

This section discusses a number of problems that may arise when using MPI in a Fortran program. It is intended as advice to users, and clarifies how MPI interacts with Fortran. It

does not add to the standard, but is intended to clarify the standard.

As noted in the original MPI specification, the interface violates the Fortran standard in several ways. While these **may** cause few problems for Fortran 77 programs, they become more significant for Fortran 90 programs, so that users must exercise care when using new Fortran 90 features. **With Fortran 2008 and the new semantics defined in TR 29113, most violations are resolved, and this is hinted at in an addendum to each item.** The violations were originally adopted and have been retained because they are important for the usability of MPI. The rest of this section describes the potential problems in detail. **[It supersedes and replaces the discussion of Fortran bindings in the original MPI specification (for Fortran 90, not Fortran 77).]**

The following MPI features are inconsistent with Fortran 90 **and Fortran 77.**

1. An MPI subroutine with a choice argument may be called with different argument types. **When using the `mpi_f08` module together with a compiler that supports Fortran 2008 + TR 29113, this problem is resolved.**
2. An MPI subroutine with an assumed-size dummy argument may be passed an actual scalar argument. **This is only solved for choice buffers through the use of `DIMENSION(...)`.**
3. **[Many]Nonblocking and split-collective** MPI routines assume that actual arguments are passed by address or descriptor and that arguments and the associated data are not copied on entrance to or exit from the subroutine. **This problem is solved with the use of the `ASYNCHRONOUS` attribute.**
4. An MPI implementation may read or modify user data (e.g., communication buffers used by nonblocking communications) concurrently with a user program that is executing outside of MPI calls. **This problem is resolved by relying on the extended semantics of the `ASYNCHRONOUS` attribute as specified in TR 29113.**
5. Several named “constants,” such as `MPI_BOTTOM`, `MPI_IN_PLACE`, `MPI_STATUS_IGNORE`, `MPI_STATUSES_IGNORE`, `MPI_ERRCODES_IGNORE`, `MPI_UNWEIGHTED`, `MPI_ARGV_NULL`, and `MPI_ARGVS_NULL` are not ordinary Fortran constants and require a special implementation. See Section 2.5.4 on page 15 for more information.
6. The memory allocation routine `MPI_ALLOC_MEM` can’t be usefully used in Fortran 77/90/95 without a language extension (for example, Cray pointers) that allows the allocated memory to be associated with a Fortran variable. **Therefore, address sized integers were used in MPI-2.0 - MPI-2.2. In Fortran 2003, `TYPE(C_PTR)` entities were added, which allow a standard-conforming implementation of the semantics of `MPI_ALLOC_MEM`. In MPI-3.0 and later, `MPI_ALLOC_MEM` has an additional, overloaded interface to support this language feature. The use of Cray pointers is deprecated. The `mpi_f08` module only supports `TYPE(C_PTR)` pointers.**

Additionally, MPI is inconsistent with Fortran 77 in a number of ways, as noted below.

- MPI identifiers exceed 6 characters.
- MPI identifiers may contain underscores after the first character.

- MPI requires an include file, `mpif.h`. On systems that do not support include files, the implementation should specify the values of named constants.
- Many routines in MPI have KIND-parameterized integers (e.g., `MPI_ADDRESS_KIND` and `MPI_OFFSET_KIND`) that hold address information. On systems that do not support Fortran 90-style parameterized types, `INTEGER*8` or `INTEGER` should be used instead.

MPI-1 contained several routines that take address-sized information as input or return address-sized information as output. In C such arguments were of type `MPI_Aint` and in Fortran of type `INTEGER`. On machines where integers are smaller than addresses, these routines can lose information. In MPI-2 the use of these functions has been deprecated and they have been replaced by routines taking `INTEGER` arguments of `KIND=MPI_ADDRESS_KIND`. A number of new MPI-2 functions also take `INTEGER` arguments of non-default `KIND`. See Section 2.6 on page 17 and Section 4.1.1 on page 93 for more information.

Sections 16.2.11 through 16.2.19 describe several problems in detail which concern the interaction of MPI and Fortran as well as their solutions. Some of these solutions require special capabilities from the compilers. Major requirements are summarized in Section 16.2.7 on page 661.

16.2.11 Problems Due to Strong Typing

[Problems Due to Strong Typing]

All MPI functions with choice arguments associate actual arguments of different Fortran datatypes with the same dummy argument. This is not allowed by Fortran 77, and in Fortran 90, it is technically only allowed if the function is overloaded with a different function for each type (see also Section 16.2.6 on page 658). In C, the use of `void*` formal arguments avoids these problems. Similar to C, with Fortran 2008 + TR 29113 (and later) together with the `mpi_f08` module, the problem is avoided by declaring choice arguments with `TYPE(*)`, `DIMENSION(..)`, i.e., as assumed-type and assumed-rank dummy arguments.

[The] Using `INCLUDE mpif.h`, the following code fragment is technically [illegal]invalid and may generate a compile-time error.

```
integer i(5)
real    x(5)
...
call mpi_send(x, 5, MPI_REAL, ...)
call mpi_send(i, 5, MPI_INTEGER, ...)
```

In practice, it is rare for compilers to do more than issue a warning[, though there is concern that Fortran 90 compilers are more likely to return errors]. Using the `mpi_f08` or `mpi` module, the problem is usually resolved through the assumed-type and assumed-rank declarations of the dummy arguments, or with a compiler-dependent mechanism that overrides type checking for choice arguments.

It is also technically [illegal]invalid in Fortran to pass a scalar actual argument to an array dummy argument that is not a choice buffer argument. Thus, when using the `mpi_f08`

or `mpi` module, the following code fragment [may generate] usually generates an error since the [buf argument] `dims` and `periods` arguments to `[MPI_SEND is declared as an assumed-size array <type> buf(*)]` `MPI_CART_CREATE` are declared as assumed size arrays `INTEGER :: DIMS(*)` and `LOGICAL :: PERIODS(*)`.

```
[integer a
call mpi_send(a, 1, MPI_INTEGER, ...) ]

USE mpi_f08      ! or USE mpi
INTEGER size
CALL MPI_Cart_create( comm_old,1,size,.TRUE.,.TRUE.,comm_cart,ierror )
```

Although this is a non-conforming MPI call, compiler warnings are not expected (but may occur) when using `INCLUDE 'mpif.h'` and this include file does not use Fortran explicit interfaces.

[

Advice to users. In the event that you run into one of the problems related to type checking, you may be able to work around it by using a compiler flag, by compiling separately, or by using an MPI implementation with Extended Fortran Support as described in Section 16.2.3. An alternative that will usually work with variables local to a routine but not with arguments to a function or subroutine is to use the `EQUIVALENCE` statement to create another variable with a type accepted by the compiler. (*End of advice to users.*)

]

16.2.12 Problems Due to Data Copying and Sequence Association with Subscript Triplets

[

Problems Due to Data Copying and Sequence Association

] Arrays with subscript **triplets** describe Fortran subarrays with or without strides, e.g.,

```
REAL a(100,100,100)
CALL MPI_Send( a(11:17, 12:99:3, 1:100), 7*30*100, MPI_REAL, ...)
```

The handling of subscript triplets depends on the value of the constant `MPI_SUBARRAYS_SUPPORTED`:

- If `MPI_SUBARRAYS_SUPPORTED` equals `.TRUE.:`

Choice buffer arguments are declared as `TYPE(*)`, `DIMENSION(...)`. For example, consider the following code fragment:

```
REAL s(100), r(100)
CALL MPI_Isend(s(1:100:5), 3, MPI_REAL, ..., rq, ierror)
CALL MPI_Wait(rq, status, ierror)
CALL MPI_Irecv(r(1:100:5), 3, MPI_REAL, ..., rq, ierror)
CALL MPI_Wait(rq, status, ierror)
```

In this case, the individual elements `s(1)`, `s(6)`, and `s(11)` are sent between the start of `MPI_ISEND` and the end of `MPI_WAIT` even though the compiled code will not copy `s(1:100:5)` to a real contiguous temporary scratch buffer. Instead, the compiled code will pass a descriptor to `MPI_ISEND` that allows MPI to operate directly on `s(1)`, `s(6)`, `s(11)`, ..., `s(96)`. The called `MPI_ISEND` routine will take only the first three of these elements due to the type signature “3, `MPI_REAL`”.

All nonblocking MPI functions (e.g., `MPI_ISEND`, `MPI_PUT`, `MPI_FILE_WRITE_ALL_BEGIN`) behave as if *the user-specified elements of choice buffers are copied to a contiguous scratch buffer in the MPI runtime environment*. All datatype descriptions (in the example above, “3, `MPI_REAL`”) read and store data from and to this virtual contiguous scratch buffer. Displacements in MPI derived datatypes are relative to the beginning of this virtual contiguous scratch buffer. Upon completion of a nonblocking receive operation (e.g., when `MPI_WAIT` on a corresponding `MPI_Request` returns), it is as if the received data has been copied from the virtual contiguous scratch buffer back to the non-contiguous application buffer. In the example above, `r(1)`, `r(6)`, and `r(11)` are guaranteed to be defined with the received data when `MPI_WAIT` returns.

Advice to implementors. The Fortran descriptor for `TYPE(*)`, `DIMENSION(..)` arguments contains enough information that, if desired, the MPI library can make a real contiguous copy of non-contiguous user buffers when the nonblocking operation is started, and released this buffer not before the nonblocking communication has completed (e.g., in an MPI wait routine). Efficient implementations may avoid such additional memory-to-memory data copying. (*End of advice to implementors.*)

Rationale. If `MPI_SUBARRAYS_SUPPORTED` equals `.TRUE.`, non-contiguous buffers are handled inside of the MPI library instead of by the compiler through argument association conventions. Therefore, the scope of MPI library scratch buffers can be from the beginning of a nonblocking operation until the completion of the operation although beginning and completion are implemented in different routines. (*End of rationale.*)

- If `MPI_SUBARRAYS_SUPPORTED` equals `.FALSE.`:

Implicit in MPI is the idea of a contiguous chunk of memory accessible through a linear address space. MPI copies data to and from this memory. An MPI program specifies the location of data by providing memory addresses and offsets. In the C language, sequence association rules plus pointers provide all the necessary low-level structure.

In Fortran [90], `[user]array` data is not necessarily stored contiguously. For example, the array section `A(1:N:2)` involves only the elements of `A` with indices 1, 3, 5, The same is true for a pointer array whose target is such a section. Most compilers ensure that an array that is a dummy argument is held in contiguous memory if it is declared with an explicit shape (e.g., `B(N)`) or is of assumed size (e.g., `B(*)`). If necessary, they do this by making a copy of the array into contiguous memory. [Both Fortran 77 and Fortran 90 are carefully worded to allow such copying to occur, but

few Fortran 77 compilers do it.]¹

Because MPI dummy buffer arguments are assumed-size arrays if `MPI_SUBARRAYS_SUPPORTED` equals `.FALSE.`, this leads to a serious problem for a nonblocking call: the compiler copies the temporary array back on return but MPI continues to copy data to the memory that held it. For example, consider the following code fragment:

```
real a(100)
call MPI_Irecv(a(1:100:2), MPI_REAL, 50, ...)
```

Since the first dummy argument to `MPI_Irecv` is an assumed-size array (`<type> buf(*)`), the array section `a(1:100:2)` is copied to a temporary before being passed to `MPI_Irecv`, so that it is contiguous in memory. `MPI_Irecv` returns immediately, and data is copied from the temporary back into the array `a`. Sometime later, MPI may write to the address of the deallocated temporary. Copying is also a problem for `MPI_Isend` since the temporary array may be deallocated before the data has all been sent from it.

Most Fortran 90 compilers do not make a copy if the actual argument is the whole of an explicit-shape or assumed-size array or is a ‘`[simple]simply contiguous`’ section such as `A(1:N)` of such an array. ([We define ‘simple’ more fully] ‘`Simply contiguous`’ is defined in the next paragraph.) Also, many compilers treat allocatable arrays the same as they treat explicit-shape arrays in this regard (though we know of one that does not). However, the same is not true for assumed-shape and pointer arrays; since they may be discontinuous, copying is often done. It is this copying that causes problems for MPI as described in the previous paragraph.

[Our formal definition of a ‘simple’] According to the Fortran 2008 Standard, Section 6.5.4, a ‘`simply contiguous`’ array section is

```
name ( [:,]... [<subscript>]:[<subscript>] [,<subscript>]... )
```

That is, there are zero or more dimensions that are selected in full, then one dimension selected without a stride, then zero or more dimensions that are selected with a simple subscript. The compiler can detect from analyzing the source code that the array is contiguous. Examples are

```
A(1:N), A(:,N), A(:,1:N,1), A(1:6,N), A(:, :, 1:N)
```

Because of Fortran’s column-major ordering, where the first index varies fastest, a ‘`[simple]simply contiguous`’ section of a contiguous array will also be contiguous. [

Footnoteremoved :

To keep the definition of ‘`simply contiguous`’ simple, we have chosen to require all but one of the section subscripts to be without bounds. A colon without bounds makes it obvious both to the compiler and to the reader that the whole of the dimension is selected. It would have been possible to allow cases where the whole dimension is selected with one or two bounds, but this means for the reader that the array declaration or most recent allocation has to be consulted and for the compiler that a run-time check may be required.]

The same problem can occur with a scalar argument. [Some]A compiler[s, even for

Fortran 77,] may make a copy of [some] scalar dummy arguments within a called procedure when passed as an actual argument to a choice buffer routine. That this can cause a problem is illustrated by the example

```
[ticket236-H.]real :: a
call user1(a,rq)
call MPI_WAIT(rq,status,ierr)
write (*,*) a

subroutine user1(buf,request)
call MPI_IRecv(buf,...,request,...)
end
```

If `a` is copied, `MPI_IRecv` will alter the copy when it completes the communication and will not alter `a` itself.

Note that copying will almost certainly occur for an argument that is a non-trivial expression (one with at least one operator or function call), a section that does not select a contiguous part of its parent (e.g., `A(1:n:2)`), a pointer whose target is such a section, or an assumed-shape array that is (directly or indirectly) associated with such a section.

If [there is] a compiler option exists that inhibits copying of arguments, in either the calling or called procedure, this [should]must be employed.

If a compiler makes copies in the calling procedure of arguments that are explicit-shape or assumed-size arrays, '[simple]simply contiguous' array sections of such arrays, or scalars, and if [there is no compiler option to inhibit this]no compiler option exists to inhibit such copying, then the compiler cannot be used for applications that use `MPI_GET_ADDRESS`, or any nonblocking MPI routine. If a compiler copies scalar arguments in the called procedure and there is no compiler option to inhibit this, then this compiler cannot be used for applications that use memory references across subroutine calls as in the example above.

16.2.13 Problems Due to Data Copying and Sequence Association with Vector Subscripts

Fortran arrays with **vector** subscripts describe subarrays containing a possibly irregular set of elements

```
REAL a(100)
CALL MPI_Send( A((/7,9,23,81,82/)), 5, MPI_REAL, ...)
```

Arrays with a vector subscript must not be used as actual choice buffer arguments in any nonblocking or split collective MPI operations. They may, however, be used in blocking MPI operations.

16.2.14 Special Constants

¹Technically, the Fortran standard is worded to allow non-contiguous storage of any array data, unless the dummy argument has the `CONTIGUOUS` attribute.

[
Special Constants
]

MPI requires a number of special “constants” that cannot be implemented as normal Fortran constants, e.g., MPI_BOTTOM. The complete list can be found in Section 2.5.4 on page 15. In C, these are implemented as constant pointers, usually as NULL and are used where the function prototype calls for a pointer to a variable, not the variable itself.

In Fortran, [the implementation of these special constants may require the use of language constructs that are outside the Fortran standard. Using]using special values for the constants (e.g., by defining them through parameter statements) is not possible because an implementation cannot distinguish these values from [legal]valid data. Typically these constants are implemented as predefined static variables (e.g., a variable in an MPI-declared COMMON block), relying on the fact that the target compiler passes data by address. Inside the subroutine, [this address can be extracted by some mechanism outside the Fortran standard (e.g., by Fortran extensions or by implementing the function in C)]the address of the actual choice buffer argument can be compared with the address of such a predefined static variable.

These special constants also cause an exception with the usage of Fortran INTENT: with USE mpi_f08, the attributes INTENT(IN), INTENT(OUT), and INTENT(INOUT) are used in the Fortran interface. In most cases, INTENT(IN) is used if the C interface uses call-by-value. For all buffer arguments and for dummy arguments that may be modified and allow one of these special constants as input, an INTENT is not specified.

16.2.15 Fortran Derived Types

[
Fortran 90 Derived Types
]

MPI[does not explicitly] supports passing Fortran[90] entities of BIND(C) and SEQUENCE derived types to choice dummy arguments, provided no type component has the ALLOCATABLE or POINTER attribute. [Indeed, for MPI implementations that provide explicit interfaces through the mpi module a compiler will reject derived type actual arguments at compile time. Even when no explicit interfaces are given, users should be aware that Fortran 90 provides no guarantee of sequence association for derived types or arrays of derived types. For instance, an array of a derived type consisting of two elements may be implemented as an array of the first elements followed by an array of the second. Use of the SEQUENCE attribute may help here, somewhat.]

The following code fragment shows [one possible way to send a]some possible ways to send scalars or arrays of interoperable derived type in Fortran. The example assumes that all data is passed by address.

```
type[ticket237-I.], BIND(C) :: mytype
  integer [ticket229.2.]:: i
  real [ticket229.2.]:: x
  double precision [ticket229.2.]:: d
  [ticket229.2.]logical :: l
```



```

1     end type mytype
2
3     type(mytype) [ticket250-V.]:: foo[ticket237-I.], fooarr(5)
4     integer [ticket250-V.]:: blocklen(4), type(4)
5     integer(KIND=MPI_ADDRESS_KIND) [ticket250-V.]:: disp(4), base[ticket237-I.], lb, extent
6
7     call MPI_GET_ADDRESS(foo%i, disp(1), ierr)
8     call MPI_GET_ADDRESS(foo%x, disp(2), ierr)
9     call MPI_GET_ADDRESS(foo%d, disp(3), ierr)
10    [ticket229.2.]call MPI_GET_ADDRESS(foo%l, disp(4), ierr)
11
12    base = disp(1)
13    disp(1) = disp(1) - base
14    disp(2) = disp(2) - base
15    disp(3) = disp(3) - base
16    [ticket229.2.]disp(4) = disp(4) - base
17
18    blocklen(1) = 1
19    blocklen(2) = 1
20    blocklen(3) = 1
21    [ticket229.2.]blocklen(4) = 1
22
23    type(1) = MPI_INTEGER
24    type(2) = MPI_REAL
25    type(3) = MPI_DOUBLE_PRECISION
26    [ticket229.2.]type(4) = MPI_LOGICAL
27
28    call MPI_TYPE_CREATE_STRUCT(4, blocklen, disp, type, newtype, ierr)
29    call MPI_TYPE_COMMIT(newtype, ierr)
30
31    [ticket237-I.][! unpleasant to send foo%i instead of foo, but it works for scalar]
32    [ticket237-I.][! entities of type mytype]
33    call MPI_SEND(foo%i, 1, newtype, ...)
34    [ticket237-I.]! or
35    [ticket237-I.]    call MPI_SEND(foo, 1, newtype, ...)
36    [ticket237-I.]    ! expects that base == address(foo%i) == address(foo)
37
38    [ticket237-I.]    call MPI_GET_ADDRESS(fooarr(1), disp(1), ierr)
39    [ticket237-I.]    call MPI_GET_ADDRESS(fooarr(2), disp(2), ierr)
40    [ticket237-I.]    extent = disp(2) - disp(1)
41    [ticket237-I.]    lb = 0
42    [ticket237-I.]    call MPI_TYPE_CREATE_RESIZED(newtype, lb, extent, newarrtype, ierr)
43    [ticket237-I.]    call MPI_TYPE_COMMIT(newarrtype, ierr)
44    [ticket237-I.]
45    [ticket237-I.]    call MPI_SEND(fooarr, 5, newarrtype, ...)
46
47
48

```

Using the derived type variable `foo` instead of its first basic type element `foo%i` may be impossible if the MPI library implements choice buffer arguments through overloading

instead of using `TYPE(*)`, `DIMENSION(...)`, or through a non-standardized extensions such as `!$PRAGMA IGNORE_TKR`; see Section 16.2.6 on page 658. [

To use a derived type in an array requires a correct extent of the datatype handle to take care of the alignment rules applied by the compiler. These alignment rules may imply that there are gaps between the elements of a derived type, and also between the array elements. [The extent of an iteroperable derived type (i.e., defined with `BIND(C)`) and a `SEQUENCE` derived type with the same content may be different because C and Fortran may apply different alignment rules. [mytype is a `SEQUENCE` derived type.]As recommended in the advice to users in Section 4.1 on page 91, one should add an additional fifth structure element with one numerical storage unit at the end of this structure to force in most cases that the array of structures is contiguous. Even with such an additional element, one should keep this resizing due to the special alignment rules that can be used by the compiler for structures, as also mentioned in this advice.

Using the extended semantics defined in TR 29113, it is also possible to use entities or derived types without either the `BIND(C)` or the `SEQUENCE` attribute as choice buffer arguments; some additional constraints must be observed e.g., no `ALLOCATABLE` or `POINTER` type components may exist. In this case, the `base` address in the example must be changed to become the address of `foo` instead of `foo%i`, because the Fortran compiler may rearrange type components or add padding as it may fit for such types. Sending the structure `foo` should then also be performed by providing it (and not `foo%i`) as actual argument for `MPI_Send`.

16.2.16 Optimization Problems, an Overview

[
A Problem with Register Optimization

] MPI provides operations that may be hidden from the user code and run concurrently with it, accessing the same memory as user code. Examples include the data transfer for an `MPI_IRECV`. The optimizer of a compiler will assume that it can recognize periods when a copy of a variable can be kept in a register without reloading from or storing to memory. When the user code is working with a register copy of some variable while the hidden operation reads or writes the memory copy, problems occur. [This section discusses register optimization pitfalls.] These problems are independent of the Fortran support method; i.e., they occur with the `mpi_f08` module, the `mpi` module, and the `mpif.h` include file.

This section shows four problematic usage areas (the abbreviations in parentheses are used in the table below):

- Use of nonblocking routines or persistent requests (*Nonbl.*).
- Use of one-sided routines (*1-sided*).
- Use of MPI parallel file I/O split collective operations (*Split*).
- Use of `MPI_BOTTOM` together with absolute displacements in MPI datatypes, or relative displacements between two variables in such datatypes (*Bottom*).

The following compiler optimization strategies (valid for serial code) may cause problems in MPI applications:

- 1 • Code movement and register optimization problems; see Section 16.2.17 on page 682.
- 2
- 3 • Temporary data movement and temporary memory modifications; see Section 16.2.18
- 4 on page 690.
- 5 • Permanent data movement (e.g., through garbage collection); see Section 16.2.19 on
- 6 page 692.
- 7

8 Table 16.4 shows in which usage areas the optimization problems may only occur.

Optimization may cause a problem in following usage areas			
	Nonbl.	1-sided	Split	Bottom
Code movement and register optimization	yes	yes	no	yes
Temporary data movement	yes	yes	yes	no
Permanent data movement	yes	yes	yes	yes

18 Table 16.4: Occurrence of Fortran optimization problems in several usage areas

20 The solutions in the following sections are based on compromises:

- 22 • to minimize the burden for the application programmer, e.g., as shown in Sections
- 23 “Solutions” to “VOLATILE” on pages 684-686,
- 24
- 25 • to minimize the drawbacks on compiler based optimization, and
- 26
- 27 • to minimize the requirements defined in Section 16.2.7 on page 661.
- 28

29 16.2.17 Problems with Code Movement and Register Optimization

30 Nonblocking operations

31 If a variable is local to a Fortran subroutine (i.e., not in a module or a COMMON block), the

32 compiler will assume that it cannot be modified by a called subroutine unless it is an actual

33 argument of the call. In the most common linkage convention, the subroutine is expected

34 to save and restore certain registers. Thus, the optimizer will assume that a register which

35 held a valid copy of such a variable before the call will still hold a valid copy on return.

36

37

38

39 **Example 16.11** Fortran 90 register optimization – extreme.

Source	compiled as	or compiled as
[ticket238-J.] REAL :: buf, b1 call MPI_Irecv(buf, ..req)	REAL :: buf, b1 call MPI_Irecv(buf, ..req) register = buf	REAL :: buf, b1 call MPI_Irecv(buf, ..req) b1 = buf
call MPI_WAIT(req, ..) b1 = buf	call MPI_WAIT(req, ..) b1 = register	call MPI_WAIT(req, ..)

46

47 Example 16.11 shows extreme, but allowed, possibilities. MPI_WAIT on a concurrent

48 thread modifies buf between the invocation of MPI_Irecv and the finish of MPI_WAIT.

But the compiler cannot see any possibility that `buf` can be changed after `MPI_IRecv` has returned, and may schedule the load of `buf` earlier than typed in the source. The compiler has no reason to avoid using a register to hold `buf` across the call to `MPI_WAIT`. It also may reorder the instructions as [in the case on the right]illustrated in the rightmost column.

[ticket238-J.]

Example 16.12 Similar example with `MPI_ISEND`

Source	compiled as	with a possible MPI-internal execution sequence
<code>REAL :: buf, copy</code>	<code>REAL :: buf, copy</code>	<code>REAL :: buf, copy</code>
<code>buf = val</code>	<code>buf = val</code>	<code>buf = val</code>
<code>call MPI_ISEND(buf,..req)</code>	<code>call MPI_ISEND(buf,..req)</code>	<code>addr = &buf</code>
<code>copy = buf</code>	<code>copy= buf</code>	<code>copy= buf</code>
	<code>buf = val_overwrite</code>	<code>buf = val_overwrite</code>
<code>call MPI_WAIT(req,..)</code>	<code>call MPI_WAIT(req,..)</code>	<code>send(*addr) ! within MPI_WAIT</code>
<code>buf = val_overwrite</code>		

Due to valid compiler code movement optimizations in Example 16.12, the content of `buf` may already be overwritten by the compiler when the content of `buf` is sent. The code movement is permitted because the compiler cannot detect a possible access to `buf` in `MPI_WAIT` (or in a second thread between the start of `MPI_ISEND` and the end of `MPI_WAIT`).

Such register optimization is based on moving code; here, the access to `buf` was moved from after `MPI_WAIT` to before `MPI_WAIT`. Note that code movement may also occur across subroutine boundaries when subroutines or functions are inlined.

This register optimization / code movement problem for nonblocking operations does not occur with MPI parallel file I/O split collective operations, because in the `..._BEGIN` and `..._END` calls, the same buffer has to be provided as an actual argument. The register optimization / code movement problem for `MPI_BOTTOM` and derived MPI datatypes may occur in each blocking and nonblocking communication or parallel file I/O operation.

One-sided communication

An example with instruction reordering due to register optimization can be found in Section 11.7.4 on page 485.

`MPI_BOTTOM` and combining independent variables in datatypes

[Normally users are not afflicted with this. But the user should pay attention to this section if in his/her program]This section is only relevant if the MPI program uses a buffer argument to an `MPI_SEND`, `MPI_RECV` etc.,[uses a name] which hides the actual variables involved. `MPI_BOTTOM` with an `MPI_Datatype` containing absolute addresses is one example. Creating a datatype which uses one variable as an anchor and brings along others by using `MPI_GET_ADDRESS` to determine their offsets from the anchor is another. The anchor variable would be the only one [mentioned]referenced in the call. Also attention must be paid if MPI operations are used that run in parallel with the user's application.

Example 16.13 shows what Fortran compilers are allowed to do.

[The]In Example 16.13, the compiler does not invalidate the register because it cannot see that `MPI_RECV` changes the value of `buf`. The access [of]to `buf` is hidden by the use of

Example 16.13 Fortran 90 register optimization.

<p>This source ...</p> <pre> call MPI_GET_ADDRESS(buf,bufaddr, ierror) call MPI_TYPE_CREATE_STRUCT(1,1, bufaddr, MPI_REAL,type,ierror) call MPI_TYPE_COMMIT(type,ierror) val_old = buf call MPI_RECV(MPI_BOTTOM,1,type,...) val_new = buf </pre>	<p>can be compiled as:</p> <pre> call MPI_GET_ADDRESS(buf,...) call MPI_TYPE_CREATE_STRUCT(...) call MPI_TYPE_COMMIT(...) register = buf val_old = register call MPI_RECV(MPI_BOTTOM,...) val_new = register </pre>
---	--

MPI_GET_ADDRESS and MPI_BOTTOM.

[ticket238-J.]

Example 16.14 Similar example with MPI_SEND

<p>This source ...</p> <pre> ! buf contains val_old buf = val_new call MPI_SEND(MPI_BOTTOM,1,type,...) ! with buf as a displacement in type buf = val_overwrite </pre>	<p>can be compiled as:</p> <pre> ! buf contains val_old call MPI_SEND(...) ! i.e. val_old is sent ! ! buf=val_new is moved to here ! and detected as dead code ! and therefore removed ! buf = val_overwrite </pre>
---	--

In Example 16.14, several successive assignments to the same variable `buf` can be combined in a way such that only the last assignment is executed. “Successive” means that no interfering load access to this variable occurs between the assignments. The compiler cannot detect that the call to `MPI_SEND` statement is interfering because the load access to `buf` is hidden by the usage of `MPI_BOTTOM`.

Solutions

The following sections show in detail how the problems with code movement and register optimization can be solved in a portable way. Application writers can partially or fully avoid these compiler optimization problems by using one or more of the special Fortran declarations with the send and receive buffers used in nonblocking operations, or in operations in which `MPI_BOTTOM` is used, or datatype handles that combine several variables are used:

- Use of the Fortran `ASYNCHRONOUS` attribute.

- Use of the helper routine `MPI_F_SYNC_REG`, or an equivalent user-written dummy routine.
- Declare the buffer as a Fortran module variable or within a Fortran common block.
- Use of the Fortran `VOLATILE` attribute.

[ticket238-J.]

Example 16.15 Protecting nonblocking communication with the `ASYNCHRONOUS` attribute.

```

USE mpi_f08
REAL, ASYNCHRONOUS :: b(0:101) ! elements 0 and 101 are halo cells
REAL :: bnew(0:101)           ! elements 1 and 100 are newly computed
TYPE(MPI_Request) :: req(4)
INTEGER :: left, right, i
CALL MPI_Cart_shift(...,left,right,...)
CALL MPI_Irecv(b( 0), ..., left, ..., req(1), ...)
CALL MPI_Irecv(b(101), ..., right, ..., req(2), ...)
CALL MPI_Isend(b( 1), ..., left, ..., req(3), ...)
CALL MPI_Isend(b(100), ..., right, ..., req(4), ...)

#ifdef WITHOUT_OVERLAPPING_COMMUNICATION_AND_COMPUTATION
! Case (a)
CALL MPI_Waitall(4,req,...)
DO i=1,100 ! compute all new local data
  bnew(i) = function(b(i-1), b(i), b(i+1))
END DO
#endif

#ifdef WITH_OVERLAPPING_COMMUNICATION_AND_COMPUTATION
! Case (b)
DO i=2,99 ! compute only elements for which halo data is not needed
  bnew(i) = function(b(i-1), b(i), b(i+1))
END DO
CALL MPI_Waitall(4,req,...)
i=1 ! compute leftmost element
  bnew(i) = function(b(i-1), b(i), b(i+1))
i=100 ! compute rightmost element
  bnew(i) = function(b(i-1), b(i), b(i+1))
#endif

```

Each of these methods solves the problems of code movement and register optimization, but may involve different degrees of performance impact, and may not be usable in every application context. These methods may not be guaranteed by the Fortran standard, but they must be guaranteed by a MPI-3.0 compliant (and later) MPI library and their compiler according to the requirements listed in Section 16.2.7 on page 661. The methods may have

different impact on performance. `MPI_F_SYNC_REG` may have low impact, module data and the `ASYNCHRONOUS` attribute low through medium, and the `VOLATILE` attribute may have the most negative impact on performance. Note that there is one attribute that cannot be used for this purpose: the Fortran `TARGET` attribute does not solve code movement problems in MPI applications.

The Fortran `ASYNCHRONOUS` attribute

Declaring an actual buffer argument with the `ASYNCHRONOUS` Fortran attribute in a scoping unit (or `BLOCK`) tells the compiler that any statement in the scoping unit may be executed while the buffer is affected by a pending asynchronous Fortran input/output operation (since Fortran 2003) or by an asynchronous communication (TR 29113 extension). Without the extensions specified in TR 29113, a Fortran compiler may totally ignore this attribute if the Fortran compiler implements asynchronous Fortran input/output operations with blocking I/O. The `ASYNCHRONOUS` attribute protects the buffer accesses from optimizations through code movements across routine calls, and the buffer itself from temporary and permanent data movements. If the choice buffer dummy argument of a nonblocking MPI routine is declared with `ASYNCHRONOUS` (which is mandatory for the `mpi_f08` module, with allowable exceptions listed in Section 16.2.6 on page 658), then the compiler has to guarantee call by reference and should report a compile-time error if call by reference is impossible, e.g., if vector subscripts are used. The `MPI_ASYNC_PROTECTS_NONBLOCKING` is set to `.TRUE.` if both the protection of the actual buffer argument through `ASYNCHRONOUS` according to the TR 29113 extension and the declaration of the dummy argument with `ASYNCHRONOUS` in the Fortran support method is guaranteed for all nonblocking routines, otherwise it is set to `.FALSE.`

The `ASYNCHRONOUS` attribute has some restrictions. The TR 29113 defines (in the PDTR N1869):

“Asynchronous communication for a Fortran variable occurs through the action of procedures defined by means other than Fortran. It is initiated by execution of an asynchronous communication initiation procedure and completed by execution of an asynchronous communication completion procedure. Between the execution of the initiation and completion procedures, any variable of which any part is associated with any part of the asynchronous communication variable is a pending communication affector. Whether a procedure is an asynchronous communication initiation or completion procedure is processor dependent. Asynchronous communication is either input communication or output communication. For input communication, a pending communication affector shall not be referenced, become defined, become undefined, become associated with a dummy argument that has the `VALUE` attribute, or have its pointer association status changed. For output communication, a pending communication affector shall not be redefined, become undefined, or have its pointer association status changed.”

In Example 16.15 Case (a) on page 685, the read accesses to `b` within `function(b(i-1), b(i), b(i+1))` cannot be moved by compiler optimizations to before the wait call because `b` was declared as `ASYNCHRONOUS`. Note that only the elements 0, 1, 100, and 101 of `b` are involved in asynchronous communication but by definition, the total variable `b` is the pending communication affector and is usable for input and output asynchronous communication

between the `MPI_I...` routines and `MPI_Waitall`. Case (a) works fine because the read accesses to `b` occur after the communication completed.

In Case (b), the read accesses to `b(1:100)` in the loop `i=2,99` are read accesses to a pending communication affector while input communication (i.e., the two `MPI_Irecv` calls) is pending. This is a contradiction to the rule that *for input communication, a pending communication affector shall not be referenced*. The problem can be solved by using separate variables for the halos and the inner array, or by splitting a common array into disjunct subarrays which are passed through different dummy arguments into a subroutine, as shown in Example 16.19 on page 694.

If one does not overlap communication and computation on the same variable, then all optimization problems can be solved through the `ASYNCHRONOUS` attribute.

The problems with `MPI_BOTTOM`, as shown in Example 16.13 and Example 16.14, can also be solved by declaring the buffer `buf` with the `ASYNCHRONOUS` attribute.

In some MPI routines, a buffer dummy argument is defined as `ASYNCHRONOUS` to guarantee passing by reference, provided that the actual argument is also defined as `ASYNCHRONOUS`.

[(Example 16.11 and its following paragraph were moved to an earlier position)]

[To prevent instruction reordering or the allocation of a buffer in a register there are two possibilities in portable Fortran code:]

Calling `MPI_F_SYNC_REG`

The compiler may be prevented from moving a reference to a buffer across a call to an MPI subroutine by surrounding the call by calls to an external subroutine with the buffer as an actual argument. The MPI library provides the `MPI_F_SYNC_REG` routine for this purpose; see Section 16.2.8 on page 663.

□

- The problems illustrated by the Examples 16.11 and 16.12 can be solved by calling `MPI_F_SYNC_REG(buf)` once immediately after `MPI_WAIT`.

Example 16.11

can be solved with

```
call MPI_Irecv(buf,..req)
```

```
call MPI_WAIT(req,..)
```

```
call MPI_F_SYNC_REG(buf)
```

```
b1 = buf
```

Example 16.12

can be solved with

```
buf = val
```

```
call MPI_Isend(buf,..req)
```

```
copy = buf
```

```
call MPI_WAIT(req,..)
```

```
call MPI_F_SYNC_REG(buf)
```

```
buf = val_overwrite
```

The call to `MPI_F_SYNC_REG(buf)` prevents moving the last line before the `MPI_WAIT` call. Further calls to `MPI_F_SYNC_REG(buf)` are not needed because it is still correct if the additional read access `copy=buf` is moved below `MPI_WAIT` and before `buf=val_overwrite`.

- The problems illustrated by the Examples 16.13 and 16.14 can be solved with two additional `MPI_F_SYNC_REG(buf)` statements; one directly before `MPI_RECV/MPI_SEND`, and one directly after this communication operation.

Example 16.13

```

can be solved with
call MPI_F_SYNC_REG(buf)
call MPI_RECV(MPI_BOTTOM,...)
call MPI_F_SYNC_REG(buf)

```

Example 16.14

```

can be solved with
call MPI_F_SYNC_REG(buf)
call MPI_SEND(MPI_BOTTOM,...)
call MPI_F_SYNC_REG(buf)

```

The first call to `MPI_F_SYNC_REG(buf)` is needed to finish all load and store references to `buf` prior to `MPI_RECV/MPI_SEND`; the second call is needed to assure that the subsequent access to `buf` are not moved before `MPI_RECV/SEND`.

- In the example in Section 11.7.4 on page 485, two asynchronous accesses must be protected: in Process 1, the access to `bbbb` must be protected similar to Example 16.11, i.e., a call to `MPI_F_SYNC_REG(bbbb)` is needed after the second `MPI_WIN_FENCE` to guarantee that further accesses to `bbbb` are not moved ahead of the call to `MPI_WIN_FENCE`. In Process 2, both calls to `MPI_WIN_FENCE` together act as a communication call with `MPI_BOTTOM` as the buffer. That is, before the first fence and after the second fence, a call to `MPI_F_SYNC_REG(buff)` is needed to guarantee that accesses to `buff` are not moved after or ahead of the calls to `MPI_WIN_FENCE`. Using `MPI_GET` instead of `MPI_PUT`, the same calls to `MPI_F_SYNC_REG` are necessary.

Source of Process 1

```

bbbb = 777

call MPI_WIN_FENCE
call MPI_PUT(bbbb
into buff of process 2)

call MPI_WIN_FENCE
call MPI_F_SYNC_REG(bbbb)

```

Source of Process 2

```

buff = 999
call MPI_F_SYNC_REG(buff)
call MPI_WIN_FENCE

call MPI_WIN_FENCE
call MPI_F_SYNC_REG(buff)
ccc = buff

```

- The temporary memory modification problem, i.e., Example 16.16 on page 690, can **not** be solved with this method.

□

A user defined routine instead of `MPI_F_SYNC_REG`

Instead of `MPI_F_SYNC_REG`, one can also use a user defined external subroutine, which is separately compiled: [with the separately compiled]

```

subroutine DD(buf)
integer buf
end

```

Note that if the intent is declared in an explicit interface for the external subroutine, it must be `OUT` or `INOUT`. The subroutine itself may have an empty body, but the compiler does not know this and has to assume that the buffer may be altered. For example, [the above] a call [of] to `MPI_RECV` with `MPI_BOTTOM` as buffer might be replaced by

```

call DD(buf)
call MPI_RECV(MPI_BOTTOM,...)
call DD(buf)

```

Such a user-defined routine was introduced in MPI-2.0 and is still included here to document such usage in existing application programs although new applications should prefer MPI_F_SYNC_REG or one of the other possibilities. In an existing application, calls to such a user-written routine should be substituted by a call to MPI_F_SYNC_REG because the user-written routine may not be implemented according to the rules specified in Section 16.2.7 on page 661.

[(assuming that buf has type INTEGER). The compiler may be similarly prevented from moving a reference to a variable across a call to an MPI subroutine.

In the case of a nonblocking call, as in the above call of MPI_WAIT, no reference to the buffer is permitted until it has been verified that the transfer has been completed. Therefore, in this case, the extra call ahead of the MPI call is not necessary, i.e., the call of MPI_WAIT in the example might be replaced by

```

/tt call MPI_WAIT(req,..)
call DD(buf) ]
[]

```

Module variables and COMMON blocks

An alternative to the already mentioned methods is to put the buffer or variable into a module or a common block and access it through a USE or COMMON statement in each scope where it is referenced, defined or appears as an actual argument in a call to an MPI routine. The compiler will then have to assume that the MPI procedure [(MPI_RECV in the above example)] may alter the buffer or variable, provided that the compiler cannot [analyze]infer that the MPI procedure does not reference the module or common block.

- This method solves problems of instruction reordering, code movement, and register optimization related to nonblocking and one-sided communication, or related to the usage of MPI_BOTTOM and derived datatype handles.
- Unfortunately, this method does **not** solve problems caused by asynchronous accesses between the start and end of a nonblocking or one-sided communication. Specifically, problems caused by temporary memory modifications are not solved.

[]

The (poorly performing) Fortran VOLATILE attribute

The VOLATILE attribute[, available in later versions of Fortran,] gives the buffer or variable the properties needed, but it may inhibit optimization of any code containing references or definitions of the buffer or variable.

The Fortran TARGET attribute

The TARGET attribute does not solve the code movement problem because it is not specified for the choice buffer dummy arguments of nonblocking routines. If the compiler detects that the application program specifies the TARGET attribute for an actual buffer argument used

in the call to a nonblocking routine, the compiler may ignore this attribute if no pointer reference to this buffer exists.

Rationale. The Fortran standardization body decided to extend the `ASYNCHRONOUS` attribute within the TR 29113 to protect buffers in nonblocking calls from all kinds of optimization, instead of extending the `TARGET` attribute. (*End of rationale.*)

16.2.18 Temporary Data Movement and Temporary Memory Modification

The compiler is allowed to temporarily modify data in memory. Normally, this problem may occur only when overlapping communication and computation, as in Example 16.15, Case (b) on page 685. Example 16.16 on page 690 shows a possibility that could be problematic.

[ticket238-J.]

Example 16.16 Overlapping Communication and Computation.

```

USE mpi_f08
REAL :: buf(100,100)
CALL MPI_Irecv(buf(1,1:100),...req,...)
DO j=1,100
  DO i=2,100
    buf(i,j)=....
  END DO
END DO
CALL MPI_Wait(req,...)

```

[ticket238-J.]

Example 16.17 The compiler may substitute the nested loops through loop fusion.

```

REAL :: buf(100,100), buf_1dim(10000)
EQUIVALENCE (buf(1,1), buf_1dim(1))
CALL MPI_Irecv(buf(1,1:100),...req,...)
tmp(1:100) = buf(1,1:100)
DO j=1,10000
  buf_1dim(h)=...
END DO
buf(1,1:100) = tmp(1:100)
CALL MPI_Wait(req,...)

```

In the compiler-generated, possible optimization in Example 16.17, `buf(100,100)` from Example 16.16 is equivalenced with the 1-dimensional array `buf_1dim(10000)`. The nonblocking receive may asynchronously receive the data in the boundary `buf(1,1:100)` while the fused loop is temporarily using this part of the buffer. When the `tmp` data is written back to `buf`, the previous data of `buf(1,1:100)` is restored and

[ticket238-J.]

Example 16.18 Another optimization is based on the usage of a separate memory storage area, e.g., in a GPU.

```

REAL :: buf(100,100), local_buf(100,100)
CALL MPI_Irecv(buf(1,1:100),...req,...)
local_buf = buf
DO j=1,100
  DO i=2,100
    local_buf(i,j)=....
  END DO
END DO
buf = local_buf ! may overwrite asynchronously received
                ! data in buf(1,1:100)
CALL MPI_Wait(req,...)

```

the received data is lost. The principle behind this optimization is that the receive buffer data `buf(1,1:100)` was temporarily moved to `tmp`.

Example 16.18 shows a second possible optimization. The whole array is temporarily moved to `local_buf`. When storing `local_buf` back to the original location `buf`, then this includes also an overwriting of the receive buffer part `buf(1,1:100)`, i.e., this storing back may overwrite the asynchronously received data.

Note, that this problem may also occur:

- With the local buffer at the origin process, between an RMA communication call and the ensuing synchronization call; see Chapter 11 on page 423.
- With the window buffer at the target process between two ensuing RMA synchronization calls.
- With the local buffer in MPI parallel file I/O split collective operations with between the `..._BEGIN` and `..._END` calls; see Section 13.4.5 on page 550.

As already mentioned in subsection *The Fortran ASYNCHRONOUS attribute* on page 686 in Section 16.2.17 on page 682, the `ASYNCHRONOUS` attribute can prevent compiler optimization with temporary data movement, but only if the receive buffer and the numerical read accesses are separated into different variables, as shown in Example 16.19 on page 694 and in Example 16.20 on page 695.

Note also that the methods

- calling `MPI_F_SYNC_REG` (or such a user-defined routine),
- using module variables and `COMMON` blocks, and
- the `TARGET` attribute

cannot be used to prevent such temporary data movement. These methods influence compiler optimization when library routines are called. They cannot prevent the optimizations of the numerical code shown in Example 16.16 and 16.17.

Note also that compiler optimization with temporary data movement should **not** be prevented by declaring `buf` as `VOLATILE` because the `VOLATILE` implies that all accesses to any storage unit (word) of `buf` must be directly done in the main memory exactly in the sequence defined by the application program. The `VOLATILE` attribute prevents all register and cache optimizations. Therefore, `VOLATILE` may cause a huge performance degradation.

Instead of solving the problem, it is needed to **prevent** the problem. When overlapping communication and computation, the nonblocking communication (or nonblocking or split collective IO) and the computation should be executed **on different sets of variables**. In this case, the temporary memory modifications are done only on the variables used in the computation and cannot have any side effect on the data used in the nonblocking MPI operations.

Rationale. This is a strong restriction for application programs. To weaken this restriction, a new or modified asynchronous feature in the Fortran language would be necessary: an asynchronous attribute that can be used on parts of an array and together with asynchronous operations outside the scope of Fortran. If such a feature is available in a later version of the Fortran standard, then this restriction also may be weakened in a later version of the MPI standard. (*End of rationale.*)

In Example 16.19 on page 694 (which is a solution for the problem shown in Example 16.15 on page 685) and in Example 16.20 on page 695 (which is a solution for the problem shown in Example 16.18 on page 691), the array is split into inner and halo part and both disjunct parts are passed to a subroutine `separated_sections`. This routine overlaps the receiving of the halo data and the calculations on the inner part of the array. In a second step, the whole array is used to do the calculation on the elements where inner+halo is needed. Note that the halo and the inner area are strided arrays. Those can be used in non-blocking communication only with a TR 29113 based MPI library.

16.2.19 Permanent Data Movement

A Fortran compiler may implement permanent data movement during the execution of a Fortran program. This would require that pointers to such data are appropriately updated. Automatic garbage collection implementation is one use case. Such permanent data movement is in conflict with MPI in several areas:

- MPI datatype handles with absolute addresses in combination with `MPI_BOTTOM`.
- Nonblocking MPI operations (communication, one-sided, I/O) if the internally used pointers to the buffers are not updated by the Fortran runtime, or if within an MPI process, the data movement is executed in parallel with the MPI operation.

This problem can be also solved by using the `ASYNCHRONOUS` attribute for such buffers. This MPI standard requires that the problems with permanent data movement do not occur by imposing suitable restrictions on the MPI library together with the compiler used; see Section 16.2.7 on page 661.

16.2.20 Comparison with C

In C, subroutines which modify variables that are not in the argument list will not cause register optimization problems. This is because taking pointers to storage objects by using

the & operator and later referencing the objects by way of the pointer is an integral part of the language. A C compiler understands the implications, so that the problem should not occur, in general. However, some compilers do offer optional aggressive optimization levels which may not be safe. **Problems due to temporary memory modifications can also occur in C. As above, the best advice is to avoid the problem: use different variables for buffers in nonblocking MPI operations and computation that is executed while the nonblocking operations are pending.**

[
]

1
2
3
4 ticket238-J.
5
6
7 ticket238-J.
8
9 ticket229.4.
10
11
12
13
14
15
16
17
18
19
20
21
22
23
24
25
26
27
28
29
30
31
32
33
34
35
36
37
38
39
40
41
42
43
44
45
46
47
48

[ticket238-J.]

Example 16.19 Using separated variables for overlapping communication and computation to allow the protection of nonblocking communication with the `ASYNCHRONOUS` attribute.

```

11 USE mpi_f08
12 REAL :: b(0:101)      ! elements 0 and 101 are halo cells
13 REAL :: bnew(0:101)  ! elements 1 and 100 are newly computed
14 INTEGER :: i
15 CALL separated_sections(b(0), b(1:100), b(101), bnew(0:101))
16 i=1 ! compute leftmost element
17   bnew(i) = function(b(i-1), b(i), b(i+1))
18 i=100 ! compute rightmost element
19   bnew(i) = function(b(i-1), b(i), b(i+1))
20 END
21
22 SUBROUTINE separated_sections(b_lefthalo, b_inner, b_righthalo, bnew)
23 USE mpi_f08
24 REAL, ASYNCHRONOUS :: b_lefthalo(0:0), b_inner(1:100), b_righthalo(101:101)
25 REAL :: bnew(0:101) ! elements 1 and 100 are newly computed
26 TYPE(MPI_Request) :: req(4)
27 INTEGER :: left, right, i
28 CALL MPI_Cart_shift(...,left,right,...)
29 CALL MPI_Irecv(b_lefthalo ( 0), ..., left, ..., req(1), ...)
30 CALL MPI_Irecv(b_righthalo(101), ..., right, ..., req(2), ...)
31 ! b_lefthalo and b_righthalo is written asynchronously.
32 ! There is no other concurrent access to b_lefthalo and b_righthalo.
33 CALL MPI_Isend(b_inner( 1), ..., left, ..., req(3), ...)
34 CALL MPI_Isend(b_inner(100), ..., right, ..., req(4), ...)
35
36 DO i=2,99 ! compute only elements for which halo data is not needed
37   bnew(i) = function(b_inner(i-1), b_inner(i), b_inner(i+1))
38   ! b_inner is read and send at the same time.
39   ! This is allowed based on the rules for ASYNCHRONOUS.
40 END DO
41 CALL MPI_Waitall(4,req,...)
42 END SUBROUTINE

```

[ticket238-J.]

Example 16.20 Protecting GPU optimizations with the `ASYNCHRONOUS` attribute.

```
USE mpi_f08
REAL :: buf(100,100)
CALL separated_sections(buf(1:1,1:100), buf(2:100,1:100))
END
```

```
SUBROUTINE separated_sections(buf_halo, buf_inner)
REAL, ASYNCHRONOUS :: buf_halo(1:1,1:100)
REAL :: buf_inner(2:100,1:100)
REAL :: local_buf(2:100,100)
```

```
CALL MPI_Irecv(buf_halo(1,1:100),...req,...)
local_buf = buf_inner
DO j=1,100
  DO i=2,100
    local_buf(i,j)=....
  END DO
END DO
buf_inner = local_buf ! buf_halo is not touched!!!

CALL MPI_Wait(req,...)
```

16.3 Language Interoperability

16.3.1 Introduction

It is not uncommon for library developers to use one language to develop an applications library that may be called by an application program written in a different language. MPI currently supports ISO (previously ANSI) C, C++, and Fortran bindings. It should be possible for applications in any of the supported languages to call MPI-related functions in another language.

Moreover, MPI allows the development of client-server code, with MPI communication used between a parallel client and a parallel server. It should be possible to code the server in one language and the clients in another language. To do so, communications should be possible between applications written in different languages.

There are several issues that need to be addressed in order to achieve interoperability.

Initialization We need to specify how the MPI environment is initialized for all languages.

Interlanguage passing of MPI opaque objects We need to specify how MPI object handles are passed between languages. We also need to specify what happens when an MPI object is accessed in one language, to retrieve information (e.g., attributes) set in another language.

Interlanguage communication We need to specify how messages sent in one language can be received in another language.

It is highly desirable that the solution for interlanguage interoperability be extensible to new languages, should MPI bindings be defined for such languages.

16.3.2 Assumptions

We assume that conventions exist for programs written in one language to call routines written in another language. These conventions specify how to link routines in different languages into one program, how to call functions in a different language, how to pass arguments between languages, and the correspondence between basic data types in different languages. In general, these conventions will be implementation dependent. Furthermore, not every basic datatype may have a matching type in other languages. For example, C/C++ character strings may not be compatible with Fortran CHARACTER variables. However, we assume that a Fortran INTEGER, as well as a (sequence associated) Fortran array of INTEGERS, can be passed to a C or C++ program. We also assume that Fortran, C, and C++ have address-sized integers. This does not mean that the default-size integers are the same size as default-sized pointers, but only that there is some way to hold (and pass) a C address in a Fortran integer. It is also assumed that INTEGER(KIND=MPI_OFFSET_KIND) can be passed from Fortran to C as MPI_Offset.

16.3.3 Initialization

A call to MPI_INIT or MPI_INIT_THREAD, from any language, initializes MPI for execution in all languages.

Advice to users. Certain implementations use the (inout) argc, argv arguments of the C/C++ version of MPI_INIT in order to propagate values for argc and argv to

all executing processes. Use of the Fortran version of MPI_INIT to initialize MPI may result in a loss of this ability. (*End of advice to users.*)

The function MPI_INITIALIZED returns the same answer in all languages.

The function MPI_FINALIZE finalizes the MPI environments for all languages.

The function MPI_FINALIZED returns the same answer in all languages.

The function MPI_ABORT kills processes, irrespective of the language used by the caller or by the processes killed.

The MPI environment is initialized in the same manner for all languages by MPI_INIT. E.g., MPI_COMM_WORLD carries the same information regardless of language: same processes, same environmental attributes, same error handlers.

Information can be added to info objects in one language and retrieved in another.

Advice to users. The use of several languages in one MPI program may require the use of special options at compile and/or link time. (*End of advice to users.*)

Advice to implementors. Implementations may selectively link language specific MPI libraries only to codes that need them, so as not to increase the size of binaries for codes that use only one language. The MPI initialization code need perform initialization for a language only if that language library is loaded. (*End of advice to implementors.*)

16.3.4 Transfer of Handles

Handles are passed between Fortran and C or C++ by using an explicit C wrapper to convert Fortran handles to C handles. There is no direct access to C or C++ handles in Fortran. Handles are passed between C and C++ using overloaded C++ operators called from C++ code. There is no direct access to C++ objects from C.

The type definition MPI_Fint is provided in C/C++ for an integer of the size that matches a Fortran INTEGER; usually, MPI_Fint will be equivalent to int. **With the Fortran mpi module or the mpif.h include file, a Fortran handle is a Fortran INTEGER value that can be used in the following conversion functions. With the Fortran mpi_f08 module, a Fortran handle is a BIND(C) derived type that contains an INTEGER field named MPI_VAL. This INTEGER value can be used in the following conversion functions.**

The following functions are provided in C to convert from a Fortran communicator handle (which is an integer) to a C communicator handle, and vice versa. See also Section 2.6.5 on page 23.

```
MPI_Comm MPI_Comm_f2c(MPI_Fint comm)
```

If comm is a valid Fortran handle to a communicator, then MPI_Comm_f2c returns a valid C handle to that same communicator; if comm = MPI_COMM_NULL (Fortran value), then MPI_Comm_f2c returns a null C handle; if comm is an invalid Fortran handle, then MPI_Comm_f2c returns an invalid C handle.

```
MPI_Fint MPI_Comm_c2f(MPI_Comm comm)
```

The function MPI_Comm_c2f translates a C communicator handle into a Fortran handle to the same communicator; it maps a null handle into a null handle and an invalid handle into an invalid handle.

Similar functions are provided for the other types of opaque objects.

```

1 MPI_Datatype MPI_Type_f2c(MPI_Fint datatype)
2
3 MPI_Fint MPI_Type_c2f(MPI_Datatype datatype)
4
5 MPI_Group MPI_Group_f2c(MPI_Fint group)
6 MPI_Fint MPI_Group_c2f(MPI_Group group)
7
8 MPI_Request MPI_Request_f2c(MPI_Fint request)
9 MPI_Fint MPI_Request_c2f(MPI_Request request)
10
11 MPI_File MPI_File_f2c(MPI_Fint file)
12 MPI_Fint MPI_File_c2f(MPI_File file)
13
14 MPI_Win MPI_Win_f2c(MPI_Fint win)
15 MPI_Fint MPI_Win_c2f(MPI_Win win)
16
17 MPI_Op MPI_Op_f2c(MPI_Fint op)
18 MPI_Fint MPI_Op_c2f(MPI_Op op)
19
20 MPI_Info MPI_Info_f2c(MPI_Fint info)
21 MPI_Fint MPI_Info_c2f(MPI_Info info)
22
23 MPI_Errhandler MPI_Errhandler_f2c(MPI_Fint errhandler)
24 MPI_Fint MPI_Errhandler_c2f(MPI_Errhandler errhandler)
25
26 MPI_Message MPI_Message_f2c(MPI_Fint message)
27 MPI_Fint MPI_Message_c2f(MPI_Message message)
28

```

ticket274.

Example 16.21 The example below illustrates how the Fortran MPI function `MPI_TYPE_COMMIT` can be implemented by wrapping the C MPI function `MPI_Type_commit` with a C wrapper to do handle conversions. In this example a Fortran-C interface is assumed where a Fortran function is all upper case when referred to from C and arguments are passed by addresses.

```

35 ! FORTRAN PROCEDURE
36 SUBROUTINE MPI_TYPE_COMMIT( DATATYPE, IERR)
37 INTEGER [ticket250-V.]:: DATATYPE, IERR
38 CALL MPI_X_TYPE_COMMIT(DATATYPE, IERR)
39 RETURN
40 END
41
42 /* C wrapper */
43
44 void MPI_X_TYPE_COMMIT( MPI_Fint *f_handle, MPI_Fint *ierr)
45 {
46     MPI_Datatype datatype;
47
48     datatype = MPI_Type_f2c( *f_handle);

```

```

    *ierr = (MPI_Fint)MPI_Type_commit( &datatype);
    *f_handle = MPI_Type_c2f(datatype);
    return;
}

```

The same approach can be used for all other MPI functions. The call to MPI_XXX_f2c (resp. MPI_XXX_c2f) can be omitted when the handle is an OUT (resp. IN) argument, rather than INOUT.

Rationale. The design here provides a convenient solution for the prevalent case, where a C wrapper is used to allow Fortran code to call a C library, or C code to call a Fortran library. The use of C wrappers is much more likely than the use of Fortran wrappers, because it is much more likely that a variable of type INTEGER can be passed to C, than a C handle can be passed to Fortran.

Returning the converted value as a function value rather than through the argument list allows the generation of efficient inlined code when these functions are simple (e.g., the identity). The conversion function in the wrapper does not catch an invalid handle argument. Instead, an invalid handle is passed below to the library function, which, presumably, checks its input arguments. (*End of rationale.*)

C and C++ The C++ language interface provides the functions listed below for mixed-language interoperability. The token <CLASS> is used below to indicate any valid MPI opaque handle name (e.g., Group), except where noted. For the case where the C++ class corresponding to <CLASS> has derived classes, functions are also provided for converting between the derived classes and the C MPI_<CLASS>.

The following function allows assignment from a C MPI handle to a C++ MPI handle.

```
MPI::<CLASS>& MPI::<CLASS>::operator=(const MPI_<CLASS>& data)
```

The constructor below creates a C++ MPI object from a C MPI handle. This allows the automatic promotion of a C MPI handle to a C++ MPI handle.

```
MPI::<CLASS>::<CLASS>(const MPI_<CLASS>& data)
```

Example 16.22 In order for a C program to use a C++ library, the C++ library must export a C interface that provides appropriate conversions before invoking the underlying C++ library call. This example shows a C interface function that invokes a C++ library call with a C communicator; the communicator is automatically promoted to a C++ handle when the underlying C++ function is invoked.

```

// C++ library function prototype
void cpp_lib_call(MPI::Intracomm cpp_comm);

```

```

// Exported C function prototype
extern "C" {
    void c_interface(MPI_Comm c_comm);
}

```

```
void c_interface(MPI_Comm c_comm)
```

```

1  {
2      // the MPI_Comm (c_comm) is automatically promoted to MPI::Intracomm
3      cpp_lib_call(c_comm);
4  }

```

The following function allows conversion from C++ objects to C MPI handles. In this case, the casting operator is overloaded to provide the functionality.

```

8  MPI::<CLASS>::operator MPI_<CLASS>() const
9

```

Example 16.23 A C library routine is called from a C++ program. The C library routine is prototyped to take an MPI_Comm as an argument.

```

13 // C function prototype
14 extern "C" {
15     void c_lib_call(MPI_Comm c_comm);
16 }
17
18 void cpp_function()
19 {
20     // Create a C++ communicator, and initialize it with a dup of
21     // MPI::COMM_WORLD
22     MPI::Intracomm cpp_comm(MPI::COMM_WORLD.Dup());
23     c_lib_call(cpp_comm);
24 }
25

```

Rationale. Providing conversion from C to C++ via constructors and from C++ to C via casting allows the compiler to make automatic conversions. Calling C from C++ becomes trivial, as does the provision of a C or Fortran interface to a C++ library. (*End of rationale.*)

Advice to users. Note that the casting and promotion operators return new handles by value. Using these new handles as INOUT parameters will affect the internal MPI object, but will *not* affect the original handle from which it was cast. (*End of advice to users.*)

It is important to note that all C++ objects with corresponding C handles can be used interchangeably by an application. For example, an application can cache an attribute on MPI_COMM_WORLD and later retrieve it from MPI::COMM_WORLD.

16.3.5 Status

The following two procedures are provided in C to convert from a Fortran (**with the mpi module or mpif.h**) status (which is an array of integers) to a C status (which is a structure), and vice versa. The conversion occurs on all the information in status, including that which is hidden. That is, no status information is lost in the conversion.

```

45 int MPI_Status_f2c(const MPI_Fint *f_status, MPI_Status *c_status)
46

```

If f_status is a valid Fortran status, but not the Fortran value of MPI_STATUS_IGNORE or MPI_STATUSES_IGNORE, then MPI_Status_f2c returns in c_status a valid C status with

the same content. If `f_status` is the Fortran value of `MPI_STATUS_IGNORE` or `MPI_STATUSES_IGNORE`, or if `f_status` is not a valid Fortran status, then the call is erroneous.

The C status has the same source, tag and error code values as the Fortran status, and returns the same answers when queried for count, elements, and cancellation. The conversion function may be called with a Fortran status argument that has an undefined error field, in which case the value of the error field in the C status argument is undefined.

Two global variables of type `MPI_Fint*`, `MPI_F_STATUS_IGNORE` and `MPI_F_STATUSES_IGNORE` are declared in `mpi.h`. They can be used to test, in C, whether `f_status` is the Fortran value of `MPI_STATUS_IGNORE` or `MPI_STATUSES_IGNORE`, [respectively.] defined in the `mpi` module or `mpif.h`. These are global variables, not C constant expressions and cannot be used in places where C requires constant expressions. Their value is defined only between the calls to `MPI_INIT` and `MPI_FINALIZE` and should not be changed by user code.

To do the conversion in the other direction, we have the following:

```
int MPI_Status_c2f(const MPI_Status *c_status, MPI_Fint *f_status)
```

This call converts a C status into a Fortran status, and has a behavior similar to `MPI_Status_f2c`. That is, the value of `c_status` must not be either `MPI_STATUS_IGNORE` or `MPI_STATUSES_IGNORE`.

Advice to users. There [is not a]exists no separate conversion function for arrays of statuses, since one can simply loop through the array, converting each status with the routines in Fig. 16.1 on page 702. (End of advice to users.)

Rationale. The handling of `MPI_STATUS_IGNORE` is required in order to layer libraries with only a C wrapper: if the Fortran call has passed `MPI_STATUS_IGNORE`, then the C wrapper must handle this correctly. Note that this constant need not have the same value in Fortran and C. If `MPI_Status_f2c` were to handle `MPI_STATUS_IGNORE`, then the type of its result would have to be `MPI_Status**`, which was considered an inferior solution. (End of rationale.)

Using the `mpi_f08` Fortran module, a status is declared as `TYPE(MPI_Status)`. The C type `MPI_F08_status` can be used to pass a Fortran `TYPE(MPI_Status)` argument into a C routine. Figure 16.1 illustrates all status conversion routines. Some are only available in C, some in both C and Fortran.

```
int MPI_Status_f082c(const MPI_F08_status *f08_status, MPI_Status
                    *c_status)
```

This C routine converts a Fortran `mpi_f08 TYPE(MPI_Status)` into a C `MPI_Status`.

```
int MPI_Status_c2f08(const MPI_Status *c_status, MPI_F08_status
                    *f08_status)
```

This C routine converts a C `MPI_Status` into a Fortran `mpi_f08 TYPE(MPI_Status)`. Two global variables of type `MPI_F08_status*`, `MPI_F08_STATUS_IGNORE` and `MPI_F08_STATUSES_IGNORE` are declared in `mpi.h`. They can be used to test, in C, whether `f_status` is the Fortran value of `MPI_STATUS_IGNORE` or `MPI_STATUSES_IGNORE` defined in the `mpi_f08` module. These are global variables, not C constant expressions and cannot be used in places where C requires constant expressions. Their value is defined only between the calls to `MPI_INIT` and `MPI_FINALIZE` and should not be changed by user code.

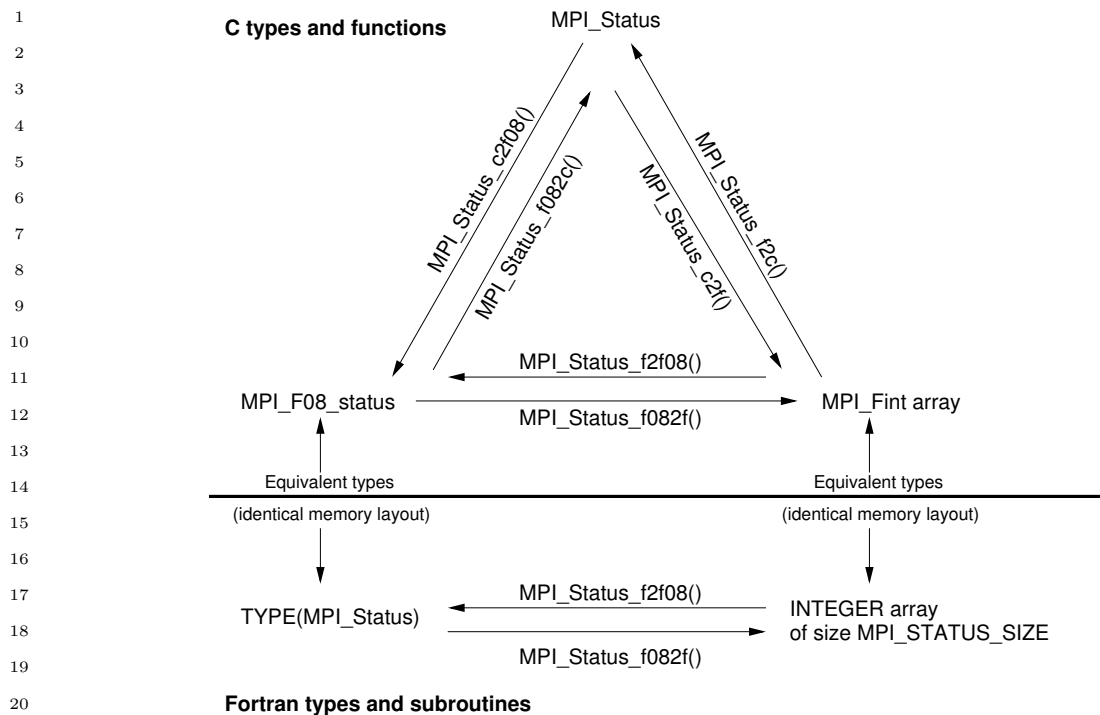

Figure 16.1: Status conversion routines

Conversion between the two Fortran versions of a status can be done with:

`MPI_STATUS_F2F08(f_status, f08_status)`

IN `f_status` status object declared as array
 OUT `f08_status` status object declared as named type

`int MPI_Status_f2f08(MPI_Fint *f_status, MPI_F08_status *f08_status)`

`MPI_Status_f2f08(f_status, f08_status, ierror) BIND(C)`

`INTEGER, INTENT(IN) :: f_status(MPI_STATUS_SIZE)`

`TYPE(MPI_Status), INTENT(OUT) :: f08_status`

`INTEGER, OPTIONAL, INTENT(OUT) :: ierror`

`MPI_STATUS_F2F08(F_STATUS, F08_STATUS, IERROR)`

`INTEGER :: F_STATUS(MPI_STATUS_SIZE)`

`TYPE(MPI_Status) :: F08_STATUS`

`INTEGER IERROR`

This routine converts a Fortran `INTEGER, DIMENSION(MPI_STATUS_SIZE)` status array into a Fortran `mpi_f08 TYPE(MPI_Status)`.

```
MPI_STATUS_F082F(f08_status, f_status)
```

```
IN      f08_status      status object declared as named type
OUT     f_status        status object declared as array
```

```
int MPI_Status_f082f(MPI_F08_status *f08_status, MPI_Fint *f_status)
```

```
MPI_Status_f082f(f08_status, f_status, ierror) BIND(C)
  TYPE(MPI_Status), INTENT(IN) :: f08_status
  INTEGER, INTENT(OUT) :: f_status(MPI_STATUS_SIZE)
  INTEGER, OPTIONAL, INTENT(OUT) :: ierror
```

```
MPI_STATUS_F082F(F08_STATUS, F_STATUS, IERROR)
  TYPE(MPI_Status) :: F08_STATUS
  INTEGER :: F_STATUS(MPI_STATUS_SIZE)
  INTEGER IERROR
```

This routine converts a Fortran `mpi_f08` `TYPE(MPI_Status)` into a Fortran `INTEGER`, `DIMENSION(MPI_STATUS_SIZE)` status array.

16.3.6 MPI Opaque Objects

Unless said otherwise, opaque objects are “the same” in all languages: they carry the same information, and have the same meaning in both languages. The mechanism described in the previous section can be used to pass references to MPI objects from language to language. An object created in one language can be accessed, modified or freed in another language.

We examine below in more detail, issues that arise for each type of MPI object.

Datatypes

Datatypes encode the same information in all languages. E.g., a datatype accessor like `MPI_TYPE_GET_EXTENT` will return the same information in all languages. If a datatype defined in one language is used for a communication call in another language, then the message sent will be identical to the message that would be sent from the first language: the same communication buffer is accessed, and the same representation conversion is performed, if needed. All predefined datatypes can be used in datatype constructors in any language. If a datatype is committed, it can be used for communication in any language.

The function `MPI_GET_ADDRESS` returns the same value in all languages. Note that we do not require that the constant `MPI_BOTTOM` have the same value in all languages (see [16.3.9](#), page 710).

Example 16.24

```
! FORTRAN CODE
REAL [ticket250-V.]:: R(5)
INTEGER [ticket250-V.]:: TYPE, IERR, AOBLN(1), AOTYPE(1)
INTEGER (KIND=MPI_ADDRESS_KIND) [ticket250-V.]:: AODISP(1)

! create an absolute datatype for array R
```

```

1  AOBLEN(1) = 5
2  CALL MPI_GET_ADDRESS( R, AODISP(1), IERR)
3  AOTYPE(1) = MPI_REAL
4  CALL MPI_TYPE_CREATE_STRUCT(1, AOBLEN,AODISP,AOTYPE, TYPE, IERR)
5  CALL C_ROUTINE(TYPE)
6
7  /* C code */
8
9  void C_ROUTINE(MPI_Fint *ftype)
10 {
11     int count = 5;
12     int lens[2] = {1,1};
13     MPI_Aint displs[2];
14     MPI_Datatype types[2], newtype;
15
16     /* create an absolute datatype for buffer that consists */
17     /* of count, followed by R(5) */
18
19     MPI_Get_address(&count, &displs[0]);
20     displs[1] = 0;
21     types[0] = MPI_INT;
22     types[1] = MPI_Type_f2c(*ftype);
23     MPI_Type_create_struct(2, lens, displs, types, &newtype);
24     MPI_Type_commit(&newtype);
25
26     MPI_Send(MPI_BOTTOM, 1, newtype, 1, 0, MPI_COMM_WORLD);
27     /* the message sent contains an int count of 5, followed */
28     /* by the 5 REAL entries of the Fortran array R. */
29 }
30

```

Advice to implementors. The following implementation can be used: MPI addresses, as returned by `MPI_GET_ADDRESS`, will have the same value in all languages. One obvious choice is that MPI addresses be identical to regular addresses. The address is stored in the datatype, when datatypes with absolute addresses are constructed. When a send or receive operation is performed, then addresses stored in a datatype are interpreted as displacements that are all augmented by a base address. This base address is (the address of) `buf`, or zero, if `buf = MPI_BOTTOM`. Thus, if `MPI_BOTTOM` is zero then a send or receive call with `buf = MPI_BOTTOM` is implemented exactly as a call with a regular buffer argument: in both cases the base address is `buf`. On the other hand, if `MPI_BOTTOM` is not zero, then the implementation has to be slightly different. A test is performed to check whether `buf = MPI_BOTTOM`. If true, then the base address is zero, otherwise it is `buf`. In particular, if `MPI_BOTTOM` does not have the same value in Fortran and C/C++, then an additional test for `buf = MPI_BOTTOM` is needed in at least one of the languages.

It may be desirable to use a value other than zero for `MPI_BOTTOM` even in C/C++, so as to distinguish it from a NULL pointer. If `MPI_BOTTOM = c` then one can still avoid the test `buf = MPI_BOTTOM`, by using the displacement from `MPI_BOTTOM`,

i.e., the regular address - c, as the MPI address returned by `MPI_GET_ADDRESS` and stored in absolute datatypes. (*End of advice to implementors.*)

Callback Functions

MPI calls may associate callback functions with MPI objects: error handlers are associated with communicators and files, attribute copy and delete functions are associated with attribute keys, reduce operations are associated with operation objects, etc. In a multilanguage environment, a function passed in an MPI call in one language may be invoked by an MPI call in another language. MPI implementations must make sure that such invocation will use the calling convention of the language the function is bound to.

Advice to implementors. Callback functions need to have a language tag. This tag is set when the callback function is passed in by the library function (which is presumably different for each language **and language support method**), and is used to generate the right calling sequence when the callback function is invoked. (*End of advice to implementors.*)

Advice to users. If a subroutine written in one language or Fortran support method wants to pass a callback routine including the predefined Fortran functions (e.g., `MPI_COMM_NULL_COPY_FN`) to another application routine written in another language or Fortran support method, then it must be guaranteed that both routines use the callback interface definition that is defined for the argument when passing the callback to an MPI routine (e.g., `MPI_COMM_CREATE_KEYVAL`); see also the advice to users on page 282. (*End of advice to users.*)

Error Handlers

Advice to implementors. Error handlers, have, in C and C++, a “`stdargs`” argument list. It might be useful to provide to the handler information on the language environment where the error occurred. (*End of advice to implementors.*)

Reduce Operations

Advice to users. Reduce operations receive as one of their arguments the datatype of the operands. Thus, one can define “polymorphic” reduce operations that work for C, C++, and Fortran datatypes. (*End of advice to users.*)

Addresses

Some of the datatype accessors and constructors have arguments of type `MPI_Aint` (in C) or `MPI::Aint` in C++, to hold addresses. The corresponding arguments, in Fortran, have type `INTEGER`. This causes Fortran and C/C++ to be incompatible, in an environment where addresses have 64 bits, but Fortran `INTEGER`s have 32 bits.

This is a problem, irrespective of interlanguage issues. Suppose that a Fortran process has an address space of ≥ 4 GB. What should be the value returned in Fortran by `MPI_ADDRESS`, for a variable with an address above 2^{32} ? The design described here addresses this issue, while maintaining compatibility with current Fortran codes.

1 The constant `MPI_ADDRESS_KIND` is defined so that, in Fortran 90,
2 `INTEGER(KIND=MPI_ADDRESS_KIND)` is an address sized integer type (typically, but not
3 necessarily, the size of an `INTEGER(KIND=MPI_ADDRESS_KIND)` is 4 on 32 bit address ma-
4 chines and 8 on 64 bit address machines). Similarly, the constant `MPI_INTEGER_KIND` is
5 defined so that `INTEGER(KIND=MPI_INTEGER_KIND)` is a default size `INTEGER`.

6 There are seven functions that have address arguments: `MPI_TYPE_HVECTOR`,
7 `MPI_TYPE_HINDEXED`, `MPI_TYPE_STRUCT`, `MPI_ADDRESS`, `MPI_TYPE_EXTENT`
8 `MPI_TYPE_LB` and `MPI_TYPE_UB`.

9 Four new functions are provided to supplement the first four functions in this list.
10 These functions are described in Section 4.1.1 on page 93. The remaining three functions
11 are supplemented by the new function `MPI_TYPE_GET_EXTENT`, described in that same
12 section. The new functions have the same functionality as the old functions in C/C++,
13 or on Fortran systems where default `INTEGER`s are address sized. In Fortran, they accept
14 arguments of type `INTEGER(KIND=MPI_ADDRESS_KIND)`, wherever arguments of type
15 `MPI_Aint` and `MPI::Aint` are used in C and C++. On Fortran 77 systems that do not support
16 the Fortran 90 `KIND` notation, and where addresses are 64 bits whereas default `INTEGER`s
17 are 32 bits, these arguments will be of an appropriate integer type. The old functions will
18 continue to be provided, for backward compatibility. However, users are encouraged to
19 switch to the new functions, in Fortran, so as to avoid problems on systems with an address
20 range $> 2^{32}$, and to provide compatibility across languages.

22 16.3.7 Attributes

23 Attribute keys can be allocated in one language and freed in another. Similarly, attribute
24 values can be set in one language and accessed in another. To achieve this, attribute keys
25 will be allocated in an integer range that is valid all languages. The same holds true for
26 system-defined attribute values (such as `MPI_TAG_UB`, `MPI_WTIME_IS_GLOBAL`, etc.)

27 Attribute keys declared in one language are associated with copy and delete functions in
28 that language (the functions provided by the `MPI_{TYPE,COMM,WIN}_CREATE_KEYVAL`
29 call). When a communicator is duplicated, for each attribute, the corresponding copy
30 function is called, using the right calling convention for the language of that function; and
31 similarly, for the delete callback function.
32

33 *Advice to implementors.* This requires that attributes be tagged either as “C,”
34 “C++” or “Fortran,” and that the language tag be checked in order to use the right
35 calling convention for the callback function. (*End of advice to implementors.*)
36

37 The attribute manipulation functions described in Section 6.7 on page 277 define at-
38 tributes arguments to be of type `void*` in C, and of type `INTEGER`, in Fortran. On some
39 systems, `INTEGER`s will have 32 bits, while C/C++ pointers will have 64 bits. This is a
40 problem if communicator attributes are used to move information from a Fortran caller to
41 a C/C++ callee, or vice-versa.

42 MPI behaves as if it stores, internally, address sized attributes. If Fortran `INTEGER`s
43 are smaller, then the Fortran function `MPI_ATTR_GET` will return the least significant part
44 of the attribute word; the Fortran function `MPI_ATTR_PUT` will set the least significant
45 part of the attribute word, which will be sign extended to the entire word. (These two
46 functions may be invoked explicitly by user code, or implicitly, by attribute copying callback
47 functions.)
48

As for addresses, new functions are provided that manipulate Fortran address sized attributes, and have the same functionality as the old functions in C/C++. These functions are described in Section 6.7, page 277. Users are encouraged to use these new functions.

MPI supports two types of attributes: address-valued (pointer) attributes, and integer valued attributes. C and C++ attribute functions put and get address valued attributes. Fortran attribute functions put and get integer valued attributes. When an integer valued attribute is accessed from C or C++, then `MPI_xxx_get_attr` will return the address of (a pointer to) the integer valued attribute, which is a pointer to `MPI_Aint` if the attribute was stored with Fortran `MPI_xxx_SET_ATTR`, and a pointer to `int` if it was stored with the deprecated Fortran `MPI_ATTR_PUT`. When an address valued attribute is accessed from Fortran, then `MPI_xxx_GET_ATTR` will convert the address into an integer and return the result of this conversion. This conversion is lossless if new style attribute functions are used, and an integer of kind `MPI_ADDRESS_KIND` is returned. The conversion may cause truncation if deprecated attribute functions are used. In C, the deprecated routines `MPI_Attr_put` and `MPI_Attr_get` behave identical to `MPI_Comm_set_attr` and `MPI_Comm_get_attr`.

Example 16.25

A. Setting an attribute value in C

```
int set_val = 3;
struct foo set_struct;

/* Set a value that is a pointer to an int */

MPI_Comm_set_attr(MPI_COMM_WORLD, keyval1, &set_val);
/* Set a value that is a pointer to a struct */
MPI_Comm_set_attr(MPI_COMM_WORLD, keyval2, &set_struct);
/* Set an integer value */
MPI_Comm_set_attr(MPI_COMM_WORLD, keyval3, (void *) 17);
```

B. Reading the attribute value in C

```
int flag, *get_val;
struct foo *get_struct;

/* Upon successful return, get_val == &set_val
   (and therefore *get_val == 3) */
MPI_Comm_get_attr(MPI_COMM_WORLD, keyval1, &get_val, &flag);
/* Upon successful return, get_struct == &set_struct */
MPI_Comm_get_attr(MPI_COMM_WORLD, keyval2, &get_struct, &flag);
/* Upon successful return, get_val == (void*) 17 */
/*      i.e., (MPI_Aint) get_val == 17 */
MPI_Comm_get_attr(MPI_COMM_WORLD, keyval3, &get_val, &flag);
```

C. Reading the attribute value with (deprecated) Fortran MPI-1 calls

```

1 LOGICAL FLAG
2 INTEGER IERR, GET_VAL, GET_STRUCT
3
4 ! Upon successful return, GET_VAL == &set_val, possibly truncated
5 CALL MPI_ATTR_GET(MPI_COMM_WORLD, KEYVAL1, GET_VAL, FLAG, IERR)
6 ! Upon successful return, GET_STRUCT == &set_struct, possibly truncated
7 CALL MPI_ATTR_GET(MPI_COMM_WORLD, KEYVAL2, GET_STRUCT, FLAG, IERR)
8 ! Upon successful return, GET_VAL == 17
9 CALL MPI_ATTR_GET(MPI_COMM_WORLD, KEYVAL3, GET_VAL, FLAG, IERR)

```

10
11 D. Reading the attribute value with Fortran MPI-2 calls

```

12
13 LOGICAL FLAG
14 INTEGER IERR
15 INTEGER (KIND=MPI_ADDRESS_KIND) GET_VAL, GET_STRUCT
16
17 ! Upon successful return, GET_VAL == &set_val
18 CALL MPI_COMM_GET_ATTR(MPI_COMM_WORLD, KEYVAL1, GET_VAL, FLAG, IERR)
19 ! Upon successful return, GET_STRUCT == &set_struct
20 CALL MPI_COMM_GET_ATTR(MPI_COMM_WORLD, KEYVAL2, GET_STRUCT, FLAG, IERR)
21 ! Upon successful return, GET_VAL == 17
22 CALL MPI_COMM_GET_ATTR(MPI_COMM_WORLD, KEYVAL3, GET_VAL, FLAG, IERR)

```

25 Example 16.26

26 A. Setting an attribute value with the (deprecated) Fortran MPI-1 call

```

27
28 INTEGER IERR, VAL
29 VAL = 7
30 CALL MPI_ATTR_PUT(MPI_COMM_WORLD, KEYVAL, VAL, IERR)

```

31 B. Reading the attribute value in C

```

32
33 int flag;
34 int *value;
35
36 /* Upon successful return, value points to internal MPI storage and
37 *value == (int) 7 */
38 MPI_Comm_get_attr(MPI_COMM_WORLD, keyval, &value, &flag);

```

39
40 C. Reading the attribute value with (deprecated) Fortran MPI-1 calls

```

41
42 LOGICAL FLAG
43 INTEGER IERR, VALUE
44
45 ! Upon successful return, VALUE == 7
46 CALL MPI_ATTR_GET(MPI_COMM_WORLD, KEYVAL, VALUE, FLAG, IERR)

```

47
48 D. Reading the attribute value with Fortran MPI-2 calls

```

LOGICAL FLAG 1
INTEGER IERR 2
INTEGER (KIND=MPI_ADDRESS_KIND) VALUE 3
4
! Upon successful return, VALUE == 7 (sign extended) 5
CALL MPI_COMM_GET_ATTR(MPI_COMM_WORLD, KEYVAL, VALUE, FLAG, IERR) 6
7

```

Example 16.27 A. Setting an attribute value via a Fortran MPI-2 call

```

INTEGER IERR 10
INTEGER(KIND=MPI_ADDRESS_KIND) VALUE1 11
INTEGER(KIND=MPI_ADDRESS_KIND) VALUE2 12
VALUE1 = 42 13
VALUE2 = INT(2, KIND=MPI_ADDRESS_KIND) ** 40 14
15
CALL MPI_COMM_SET_ATTR(MPI_COMM_WORLD, KEYVAL1, VALUE1, IERR) 16
CALL MPI_COMM_SET_ATTR(MPI_COMM_WORLD, KEYVAL2, VALUE2, IERR) 17
18

```

B. Reading the attribute value in C

```

int flag; 20
MPI_Aint *value1, *value2; 21
22
/* Upon successful return, value1 points to internal MPI storage and 23
   *value1 == 42 */ 24
MPI_Comm_get_attr(MPI_COMM_WORLD, keyval1, &value1, &flag); 25
/* Upon successful return, value2 points to internal MPI storage and 26
   *value2 == 2^40 */ 27
MPI_Comm_get_attr(MPI_COMM_WORLD, keyval2, &value2, &flag); 28
29

```

C. Reading the attribute value with (deprecated) Fortran MPI-1 calls

```

LOGICAL FLAG 31
INTEGER IERR, VALUE1, VALUE2 32
33
! Upon successful return, VALUE1 == 42 34
CALL MPI_ATTR_GET(MPI_COMM_WORLD, KEYVAL1, VALUE1, FLAG, IERR) 35
! Upon successful return, VALUE2 == 2^40, or 0 if truncation 36
! needed (i.e., the least significant part of the attribute word) 37
CALL MPI_ATTR_GET(MPI_COMM_WORLD, KEYVAL2, VALUE2, FLAG, IERR) 38
39

```

D. Reading the attribute value with Fortran MPI-2 calls

```

LOGICAL FLAG 41
INTEGER IERR 42
INTEGER (KIND=MPI_ADDRESS_KIND) VALUE1, VALUE2 43
44
! Upon successful return, VALUE1 == 42 45
CALL MPI_COMM_GET_ATTR(MPI_COMM_WORLD, KEYVAL1, VALUE1, FLAG, IERR) 46
! Upon successful return, VALUE2 == 2^40 47
CALL MPI_COMM_GET_ATTR(MPI_COMM_WORLD, KEYVAL2, VALUE2, FLAG, IERR) 48

```

1 The predefined MPI attributes can be integer valued or address valued. Predefined
 2 integer valued attributes, such as `MPI_TAG_UB`, behave as if they were put by a call to
 3 the deprecated Fortran routine `MPI_ATTR_PUT`, i.e., in Fortran,
 4 `MPI_COMM_GET_ATTR(MPI_COMM_WORLD, MPI_TAG_UB, val, flag, ierr)` will return
 5 in `val` the upper bound for tag value; in C, `MPI_Comm_get_attr(MPI_COMM_WORLD,`
 6 `MPI_TAG_UB, &p, &flag)` will return in `p` a pointer to an int containing the upper bound
 7 for tag value.

8 Address valued predefined attributes, such as `MPI_WIN_BASE` behave as if they were
 9 put by a C call, i.e., in Fortran, `MPI_WIN_GET_ATTR(win, MPI_WIN_BASE, val, flag,`
 10 `ierror)` will return in `val` the base address of the window, converted to an integer. In C,
 11 `MPI_Win_get_attr(win, MPI_WIN_BASE, &p, &flag)` will return in `p` a pointer to the window
 12 base, cast to `(void *)`.

13
 14 *Rationale.* The design is consistent with the behavior specified for predefined at-
 15 tributes, and ensures that no information is lost when attributes are passed from
 16 language to language. Because the language interoperability for predefined attributes
 17 was defined based on `MPI_ATTR_PUT`, this definition is kept for compatibility reasons
 18 although the routine itself is now deprecated. (*End of rationale.*)

19
 20 *Advice to implementors.* Implementations should tag attributes either as (1) address
 21 attributes, (2) as `INTEGER(KIND=MPI_ADDRESS_KIND)` attributes or (3) as `INTEGER`
 22 attributes, according to whether they were set in (1) C (with `MPI_Attr_put` or
 23 `MPI_Xxx_set_attr`), (2) in Fortran with `MPI_XXX_SET_ATTR` or (3) with the depre-
 24 cated Fortran routine `MPI_ATTR_PUT`. Thus, the right choice can be made when the
 25 attribute is retrieved. (*End of advice to implementors.*)

26 16.3.8 Extra State

27
 28 Extra-state should not be modified by the copy or delete callback functions. (This is obvious
 29 from the C binding, but not obvious from the Fortran binding). However, these functions
 30 may update state that is indirectly accessed via extra-state. E.g., in C, extra-state can be
 31 a pointer to a data structure that is modified by the copy or callback functions; in Fortran,
 32 extra-state can be an index into an entry in a `COMMON` array that is modified by the copy
 33 or callback functions. In a multithreaded environment, users should be aware that distinct
 34 threads may invoke the same callback function concurrently: if this function modifies state
 35 associated with extra-state, then mutual exclusion code must be used to protect updates
 36 and accesses to the shared state.
 37

38 16.3.9 Constants

39
 40 MPI constants have the same value in all languages, unless specified otherwise. This does not
 41 apply to constant handles (`MPI_INT`, `MPI_COMM_WORLD`, `MPI_ERRORS_RETURN`, `MPI_SUM`,
 42 etc.) These handles need to be converted, as explained in Section 16.3.4. Constants that
 43 specify maximum lengths of strings (see Section A.1.1 for a listing) have a value one less in
 44 Fortran than C/C++ since in C/C++ the length includes the null terminating character.
 45 Thus, these constants represent the amount of space which must be allocated to hold the
 46 largest possible such string, rather than the maximum number of printable characters the
 47 string could contain.
 48

Advice to users. This definition means that it is safe in C/C++ to allocate a buffer to receive a string using a declaration like

```
char name [MPI_MAX_OBJECT_NAME];
```

(End of advice to users.)

Also constant “addresses,” i.e., special values for reference arguments that are not handles, such as MPI_BOTTOM or MPI_STATUS_IGNORE may have different values in different languages.

Rationale. The current MPI standard specifies that MPI_BOTTOM can be used in initialization expressions in C, but not in Fortran. Since Fortran does not normally support call by value, then MPI_BOTTOM must be in Fortran the name of a predefined static variable, e.g., a variable in an MPI declared COMMON block. On the other hand, in C, it is natural to take MPI_BOTTOM = 0 (Caveat: Defining MPI_BOTTOM = 0 implies that NULL pointer cannot be distinguished from MPI_BOTTOM; it may be that MPI_BOTTOM = 1 is better ...) Requiring that the Fortran and C values be the same will complicate the initialization process. *(End of rationale.)*

16.3.10 Interlanguage Communication

The type matching rules for communication[s] in MPI are not changed: the datatype specification for each item sent should match, in type signature, the datatype specification used to receive this item (unless one of the types is MPI_PACKED). Also, the type of a message item should match the type declaration for the corresponding communication buffer location, unless the type is MPI_BYTE or MPI_PACKED. Interlanguage communication is allowed if it complies with these rules.

Example 16.28 In the example below, a Fortran array is sent from Fortran and received in C.

```
! FORTRAN CODE
USE mpi_f08
REAL [ticket250-V.]:: R(5)
INTEGER [ticket250-V.]:: IERR, MYRANK, AOBLEN(1), AOTYPE(1)
[ticket250-V.]TYPE(MPI_Type) :: TYPE
INTEGER (KIND=MPI_ADDRESS_KIND) [ticket250-V.]:: AODISP(1)

! create an absolute datatype for array R
AOBLEN(1) = 5
CALL MPI_GET_ADDRESS( R, AODISP(1), IERR)
AOTYPE(1) = MPI_REAL
CALL MPI_TYPE_CREATE_STRUCT(1, AOBLEN,AODISP,AOTYPE, TYPE, IERR)
CALL MPI_TYPE_COMMIT(TYPE, IERR)

CALL MPI_COMM_RANK( MPI_COMM_WORLD, MYRANK, IERR)
IF (MYRANK.EQ.0) THEN
  CALL MPI_SEND( MPI_BOTTOM, 1, TYPE, 1, 0, MPI_COMM_WORLD, IERR)
```

```
1  ELSE
2      CALL C_ROUTINE(TYPE[ticket250-V.]%MPI_VAL)
3  END IF
4
5
6  /* C code */
7
8  void C_ROUTINE(MPI_Fint *fhandle)
9  {
10     MPI_Datatype type;
11     MPI_Status status;
12
13     type = MPI_Type_f2c(*fhandle);
14
15     MPI_Recv( MPI_BOTTOM, 1, type, 0, 0, MPI_COMM_WORLD, &status);
16 }
17
```

18 MPI implementors may weaken these type matching rules, and allow messages to be
19 sent with Fortran types and received with C types, and vice versa, when those types match.
20 I.e., if the Fortran type INTEGER is identical to the C type int, then an MPI implementation
21 may allow data to be sent with datatype MPI_INTEGER and be received with datatype
22 MPI_INT. However, such code is not portable.

23
24
25
26
27
28
29
30
31
32
33
34
35
36
37
38
39
40
41
42
43
44
45
46
47
48

1
2
3
4
5
6
7
8
9
10
11
12
13
14
15
16
17
18
19
20
21
22
23
24
25
26
27
28
29
30
31
32
33
34
35
36
37
38
39
40
41
42
43
44
45
46
47
48

Annex A

Language Bindings Summary

In this section we summarize the specific bindings for C, Fortran, and C++. First we present the constants, type definitions, info values and keys. Then we present the routine prototypes separately for each binding. Listings are alphabetical within chapter.

A.1 Defined Values and Handles

A.1.1 Defined Constants

The C and Fortran name is listed in the left column and the C++ name is listed in the middle or right column. Constants with the type `const int` may also be implemented as literal integer constants substituted by the preprocessor.

Return Codes	
C type: <code>const int</code> (or unnamed <code>enum</code>)	C++ type: <code>const int</code>
Fortran type: <code>INTEGER</code>	(or unnamed <code>enum</code>)
<code>MPI_SUCCESS</code>	<code>MPI::SUCCESS</code>
<code>MPI_ERR_BUFFER</code>	<code>MPI::ERR_BUFFER</code>
<code>MPI_ERR_COUNT</code>	<code>MPI::ERR_COUNT</code>
<code>MPI_ERR_TYPE</code>	<code>MPI::ERR_TYPE</code>
<code>MPI_ERR_TAG</code>	<code>MPI::ERR_TAG</code>
<code>MPI_ERR_COMM</code>	<code>MPI::ERR_COMM</code>
<code>MPI_ERR_RANK</code>	<code>MPI::ERR_RANK</code>
<code>MPI_ERR_REQUEST</code>	<code>MPI::ERR_REQUEST</code>
<code>MPI_ERR_ROOT</code>	<code>MPI::ERR_ROOT</code>
<code>MPI_ERR_GROUP</code>	<code>MPI::ERR_GROUP</code>
<code>MPI_ERR_OP</code>	<code>MPI::ERR_OP</code>
<code>MPI_ERR_TOPOLOGY</code>	<code>MPI::ERR_TOPOLOGY</code>
<code>MPI_ERR_DIMS</code>	<code>MPI::ERR_DIMS</code>
<code>MPI_ERR_ARG</code>	<code>MPI::ERR_ARG</code>
<code>MPI_ERR_UNKNOWN</code>	<code>MPI::ERR_UNKNOWN</code>
<code>MPI_ERR_TRUNCATE</code>	<code>MPI::ERR_TRUNCATE</code>
<code>MPI_ERR_OTHER</code>	<code>MPI::ERR_OTHER</code>
<code>MPI_ERR_INTERN</code>	<code>MPI::ERR_INTERN</code>
<code>MPI_ERR_PENDING</code>	<code>MPI::ERR_PENDING</code>

(Continued on next page)

Return Codes (continued)

1		
2	MPI_ERR_IN_STATUS	MPI::ERR_IN_STATUS
3	MPI_ERR_ACCESS	MPI::ERR_ACCESS
4	MPI_ERR_AMODE	MPI::ERR_AMODE
5	MPI_ERR_ASSERT	MPI::ERR_ASSERT
6	MPI_ERR_BAD_FILE	MPI::ERR_BAD_FILE
7	MPI_ERR_BASE	MPI::ERR_BASE
8	MPI_ERR_CONVERSION	MPI::ERR_CONVERSION
9	MPI_ERR_DISP	MPI::ERR_DISP
10	MPI_ERR_DUP_DATAREP	MPI::ERR_DUP_DATAREP
11	MPI_ERR_FILE_EXISTS	MPI::ERR_FILE_EXISTS
12	MPI_ERR_FILE_IN_USE	MPI::ERR_FILE_IN_USE
13	MPI_ERR_FILE	MPI::ERR_FILE
14	MPI_ERR_INFO_KEY	MPI::ERR_INFO_VALUE
15	MPI_ERR_INFO_NOKEY	MPI::ERR_INFO_NOKEY
16	MPI_ERR_INFO_VALUE	MPI::ERR_INFO_KEY
17	MPI_ERR_INFO	MPI::ERR_INFO
18	MPI_ERR_IO	MPI::ERR_IO
19	MPI_ERR_KEYVAL	MPI::ERR_KEYVAL
20	MPI_ERR_LOCKTYPE	MPI::ERR_LOCKTYPE
21	MPI_ERR_NAME	MPI::ERR_NAME
22	MPI_ERR_NO_MEM	MPI::ERR_NO_MEM
23	MPI_ERR_NOT_SAME	MPI::ERR_NOT_SAME
24	MPI_ERR_NO_SPACE	MPI::ERR_NO_SPACE
25	MPI_ERR_NO_SUCH_FILE	MPI::ERR_NO_SUCH_FILE
26	MPI_ERR_PORT	MPI::ERR_PORT
27	MPI_ERR_QUOTA	MPI::ERR_QUOTA
28	MPI_ERR_READ_ONLY	MPI::ERR_READ_ONLY
29	MPI_ERR_RMA_CONFLICT	MPI::ERR_RMA_CONFLICT
30	MPI_ERR_RMA_SYNC	MPI::ERR_RMA_SYNC
31	MPI_ERR_SERVICE	MPI::ERR_SERVICE
32	MPI_ERR_SIZE	MPI::ERR_SIZE
33	MPI_ERR_SPAWN	MPI::ERR_SPAWN
34	MPI_ERR_UNSUPPORTED_DATAREP	MPI::ERR_UNSUPPORTED_DATAREP
35	MPI_ERR_UNSUPPORTED_OPERATION	MPI::ERR_UNSUPPORTED_OPERATION
36	MPI_ERR_WIN	MPI::ERR_WIN
37	MPI_ERR_LASTCODE	MPI::ERR_LASTCODE
38	[ticket270.]MPI_ERR_RMA_RANGE	[ticket270.]Not defined for C++
39	[ticket270.]MPI_ERR_RMA_ATTACH	[ticket270.]Not defined for C++

ticket266.

40
41
42
43
44
45
46
47
48

Return Codes for the MPI tool information interface

MPI_T_ERR_CANTINIT
 MPI_T_ERR_NOTINITIALIZED
 MPI_T_ERR_MEMORY
 MPI_T_ERR_INVALIDINDEX
 MPI_T_ERR_INVALIDITEM
 MPI_T_ERR_INVALIDSESSION
 MPI_T_ERR_INVALIDHANDLE
 MPI_T_ERR_OUTOFHANDLES
 MPI_T_ERR_OUTOFSESSIONS
 MPI_T_ERR_CVAR_SETNOTNOW
 MPI_T_ERR_CVAR_SETNEVER
 MPI_T_ERR_PVAR_NOWRITE
 MPI_T_ERR_PVAR_NOSTARTSTOP
 MPI_T_ERR_PVAR_NOATOMIC

Buffer Address Constants

C type: void * const	C++ type:
Fortran type: (predefined memory location)	void * const
MPI_BOTTOM	MPI::BOTTOM
MPI_IN_PLACE	MPI::IN_PLACE

Assorted Constants

C type: const int (or unnamed enum)	C++ type:
Fortran type: INTEGER	const int (or unnamed enum)
MPI_PROC_NULL	MPI::PROC_NULL
MPI_ANY_SOURCE	MPI::ANY_SOURCE
MPI_ANY_TAG	MPI::ANY_TAG
MPI_UNDEFINED	MPI::UNDEFINED
MPI_BSEND_OVERHEAD	MPI::BSEND_OVERHEAD
MPI_KEYVAL_INVALID	MPI::KEYVAL_INVALID
MPI_LOCK_EXCLUSIVE	MPI::LOCK_EXCLUSIVE
MPI_LOCK_SHARED	MPI::LOCK_SHARED
MPI_ROOT	MPI::ROOT

[ticket247-S.] Fortran Support Method Specific Constants

Fortran type: LOGICAL

[ticket234-F.] MPI_SUBARRAYS_SUPPORTED (Fortran only)

[ticket238-J.] [ticket229.1.] MPI_ASYNC_PROTECTS_NONBLOCKING (Fortran only)

Status size and reserved index values (Fortran only)

Fortran type: INTEGER

MPI_STATUS_SIZE	Not defined for C++
MPI_SOURCE	Not defined for C++
MPI_TAG	Not defined for C++
MPI_ERROR	Not defined for C++

Variable Address Size (Fortran only)

Fortran type: INTEGER

MPI_ADDRESS_KIND	Not defined for C++
[ticket265.]MPI_COUNT_KIND	[ticket265.]Not defined for C++
MPI_INTEGER_KIND	Not defined for C++
MPI_OFFSET_KIND	Not defined for C++

Error-handling specifiers

C type: MPI_Errhandler	C++ type: MPI::Errhandler
Fortran type: INTEGER	
[ticket231-C.]or TYPE(MPI_Errhandler)	
MPI_ERRORS_ARE_FATAL	MPI::ERRORS_ARE_FATAL
MPI_ERRORS_RETURN	MPI::ERRORS_RETURN
	MPI::ERRORS_THROW_EXCEPTIONS

Maximum Sizes for Strings

C type: const int (or unnamed enum)	C++ type:
Fortran type: INTEGER	const int (or unnamed enum)
MPI_MAX_PROCESSOR_NAME	MPI::MAX_PROCESSOR_NAME
[ticket204.]MPI_MAX_LIBRARY_VERSION_STRING	
MPI_MAX_ERROR_STRING	MPI::MAX_ERROR_STRING
MPI_MAX_DATAREP_STRING	MPI::MAX_DATAREP_STRING
MPI_MAX_INFO_KEY	MPI::MAX_INFO_KEY
MPI_MAX_INFO_VAL	MPI::MAX_INFO_VAL
MPI_MAX_OBJECT_NAME	MPI::MAX_OBJECT_NAME
MPI_MAX_PORT_NAME	MPI::MAX_PORT_NAME

Named Predefined Datatypes		C/C++ types	1 2
C type: MPI_Datatype	C++ type: MPI::Datatype		3
Fortran type: INTEGER			4
[ticket231-C.]or TYPE(MPI_Datatype)			5
MPI_CHAR	MPI::CHAR	char (treated as printable character)	6 8
MPI_SHORT	MPI::SHORT	signed short int	
MPI_INT	MPI::INT	signed int	10
MPI_LONG	MPI::LONG	signed long	11
MPI_LONG_LONG_INT	MPI::LONG_LONG_INT	signed long long	
MPI_LONG_LONG	MPI::LONG_LONG	long long (synonym)	
MPI_SIGNED_CHAR	MPI::SIGNED_CHAR	signed char (treated as integral value)	14
MPI_UNSIGNED_CHAR	MPI::UNSIGNED_CHAR	unsigned char (treated as integral value)	16
MPI_UNSIGNED_SHORT	MPI::UNSIGNED_SHORT	unsigned short	18
MPI_UNSIGNED	MPI::UNSIGNED	unsigned int	19
MPI_UNSIGNED_LONG	MPI::UNSIGNED_LONG	unsigned long	20
MPI_UNSIGNED_LONG_LONG	MPI::UNSIGNED_LONG_LONG	unsigned long long	
MPI_FLOAT	MPI::FLOAT	float	22
MPI_DOUBLE	MPI::DOUBLE	double	23
MPI_LONG_DOUBLE	MPI::LONG_DOUBLE	long double	24
MPI_WCHAR	MPI::WCHAR	wchar_t (defined in <stddef.h> (treated as printable character))	25 28
MPI_C_BOOL	(use C datatype handle)	_Bool	29
MPI_INT8_T	(use C datatype handle)	int8_t	30
MPI_INT16_T	(use C datatype handle)	int16_t	31
MPI_INT32_T	(use C datatype handle)	int32_t	32
MPI_INT64_T	(use C datatype handle)	int64_t	33
MPI_UINT8_T	(use C datatype handle)	uint8_t	34
MPI_UINT16_T	(use C datatype handle)	uint16_t	35
MPI_UINT32_T	(use C datatype handle)	uint32_t	36
MPI_UINT64_T	(use C datatype handle)	uint64_t	37
MPI_AINT	(use C datatype handle)	MPI_Aint	38
[ticket265.]MPI_COUNT	[ticket265.](use C datatype handle)	[ticket265.]MPI_Count	39
MPI_OFFSET	(use C datatype handle)	MPI_Offset	40
MPI_C_COMPLEX	(use C datatype handle)	float _Complex	41
MPI_C_FLOAT_COMPLEX	(use C datatype handle)	float _Complex	42
MPI_C_DOUBLE_COMPLEX	(use C datatype handle)	double _Complex	43
MPI_C_LONG_DOUBLE_COMPLEX	(use C datatype handle)	long double _Complex	44
MPI_BYTE	MPI::BYTE	(any C/C++ type)	
MPI_PACKED	MPI::PACKED	(any C/C++ type)	

47

48

Named Predefined Datatypes		Fortran types
C type: MPI_Datatype	C++ type: MPI::Datatype	
Fortran type: INTEGER		
[ticket231-C.]or TYPE(MPI_Datatype)		
MPI_INTEGER	MPI::INTEGER	INTEGER
MPI_REAL	MPI::REAL	REAL
MPI_DOUBLE_PRECISION	MPI::DOUBLE_PRECISION	DOUBLE PRECISION
MPI_COMPLEX	MPI::F_COMPLEX	COMPLEX
MPI_LOGICAL	MPI::LOGICAL	LOGICAL
MPI_CHARACTER	MPI::CHARACTER	CHARACTER(1)
MPI_AINT	(use C datatype handle)	INTEGER (KIND=MPI_ADDRESS_KIND)
[ticket265.]MPI_COUNT	(use C datatype handle)	[ticket265.]INTEGER (KIND=MPI_COUNT_KIND)
MPI_OFFSET	(use C datatype handle)	INTEGER (KIND=MPI_OFFSET_KIND)
MPI_BYTE	MPI::BYTE	(any Fortran type)
MPI_PACKED	MPI::PACKED	(any Fortran type)

C++-Only Named Predefined Datatypes	C++ types
-------------------------------------	-----------

C++ type: MPI::Datatype	
MPI::BOOL	bool
MPI::COMPLEX	Complex<float>
MPI::DOUBLE_COMPLEX	Complex<double>
MPI::LONG_DOUBLE_COMPLEX	Complex<long double>

Optional datatypes (Fortran)		Fortran types
C type: MPI_Datatype	C++ type: MPI::Datatype	
Fortran type: INTEGER		
[ticket231-C.]or TYPE(MPI_Datatype)		
MPI_DOUBLE_COMPLEX	MPI::F_DOUBLE_COMPLEX	DOUBLE COMPLEX
MPI_INTEGER1	MPI::INTEGER1	INTEGER*1
MPI_INTEGER2	MPI::INTEGER2	INTEGER*[ticket231-C.] [8] 2
MPI_INTEGER4	MPI::INTEGER4	INTEGER*4
MPI_INTEGER8	MPI::INTEGER8	INTEGER*8
MPI_INTEGER16	[ticket0.202.]MPI::INTEGER16	INTEGER*16
MPI_REAL2	MPI::REAL2	REAL*2
MPI_REAL4	MPI::REAL4	REAL*4
MPI_REAL8	MPI::REAL8	REAL*8
MPI_REAL16	[ticket0.202.]MPI::REAL16	REAL*16
MPI_COMPLEX4	[ticket0.202.]MPI::F_COMPLEX4	COMPLEX*4
MPI_COMPLEX8	[ticket0.202.]MPI::F_COMPLEX8	COMPLEX*8
MPI_COMPLEX16	[ticket0.202.]MPI::F_COMPLEX16	COMPLEX*16
MPI_COMPLEX32	[ticket0.202.]MPI::F_COMPLEX32	COMPLEX*32

Datatypes for reduction functions (C and C++)

C type: MPI_Datatype	C++ type: MPI::Datatype
Fortran type: INTEGER	
[ticket231-C.]or TYPE(MPI_Datatype)	
MPI_FLOAT_INT	MPI::FLOAT_INT
MPI_DOUBLE_INT	MPI::DOUBLE_INT
MPI_LONG_INT	MPI::LONG_INT
MPI_2INT	MPI::TWOINT
MPI_SHORT_INT	MPI::SHORT_INT
MPI_LONG_DOUBLE_INT	MPI::LONG_DOUBLE_INT

Datatypes for reduction functions (Fortran)

C type: MPI_Datatype	C++ type: MPI::Datatype
Fortran type: INTEGER	
[ticket231-C.]or TYPE(MPI_Datatype)	
MPI_2REAL	MPI::TWOREAL
MPI_2DOUBLE_PRECISION	MPI::TWODOUBLE_PRECISION
MPI_2INTEGER	MPI::TWOINTEGER

Special datatypes for constructing derived datatypes

C type: MPI_Datatype	C++ type: MPI::Datatype
Fortran type: INTEGER	
[ticket231-C.]or TYPE(MPI_Datatype)	
MPI_UB	MPI::UB
MPI_LB	MPI::LB

Reserved communicators

C type: MPI_Comm	C++ type: MPI::Intracomm
Fortran type: INTEGER	
[ticket231-C.]or TYPE(MPI_Comm)	
MPI_COMM_WORLD	MPI::COMM_WORLD
MPI_COMM_SELF	MPI::COMM_SELF

Communicator split type constants

C type: `const int` (or unnamed `enum`)

Fortran type: `INTEGER`

`MPI_COMM_TYPE_SHARED`

ticket287.

Results of communicator and group comparisons

C type: <code>const int</code> (or unnamed enum)	C++ type: <code>const int</code>
Fortran type: <code>INTEGER</code>	(or unnamed enum)
<code>MPI_IDENT</code>	<code>MPI::IDENT</code>
<code>MPI_CONGRUENT</code>	<code>MPI::CONGRUENT</code>
<code>MPI_SIMILAR</code>	<code>MPI::SIMILAR</code>
<code>MPI_UNEQUAL</code>	<code>MPI::UNEQUAL</code>

Environmental inquiry keys

C type: <code>const int</code> (or unnamed enum)	C++ type: <code>const int</code>
Fortran type: <code>INTEGER</code>	(or unnamed enum)
<code>MPI_TAG_UB</code>	<code>MPI::TAG_UB</code>
<code>MPI_IO</code>	<code>MPI::IO</code>
<code>MPI_HOST</code>	<code>MPI::HOST</code>
<code>MPI_WTIME_IS_GLOBAL</code>	<code>MPI::WTIME_IS_GLOBAL</code>

Collective Operations

C type: <code>MPI_Op</code>	C++ type: <code>const MPI::Op</code>
Fortran type: <code>INTEGER</code>	
[ticket231-C.]or <code>TYPE(MPI_Op)</code>	
<code>MPI_MAX</code>	<code>MPI::MAX</code>
<code>MPI_MIN</code>	<code>MPI::MIN</code>
<code>MPI_SUM</code>	<code>MPI::SUM</code>
<code>MPI_PROD</code>	<code>MPI::PROD</code>
<code>MPI_MAXLOC</code>	<code>MPI::MAXLOC</code>
<code>MPI_MINLOC</code>	<code>MPI::MINLOC</code>
<code>MPI_BAND</code>	<code>MPI::BAND</code>
<code>MPI_BOR</code>	<code>MPI::BOR</code>
<code>MPI_BXOR</code>	<code>MPI::BXOR</code>
<code>MPI_LAND</code>	<code>MPI::LAND</code>
<code>MPI_LOR</code>	<code>MPI::LOR</code>
<code>MPI_LXOR</code>	<code>MPI::LXOR</code>
<code>MPI_REPLACE</code>	<code>MPI::REPLACE</code>
[ticket270.] <code>MPI_NO_OP</code>	i[ticket270.]Not defined for C++

Null Handles		1
C/Fortran name	C++ name	2
C type / Fortran type	C++ type	3
MPI_GROUP_NULL	MPI::GROUP_NULL	4
MPI_Group / INTEGER	const MPI::Group	5
[ticket231-C.] or TYPE(MPI_Group)		6
MPI_COMM_NULL	MPI::COMM_NULL	7
MPI_Comm / INTEGER	¹⁾	8
[ticket231-C.] or TYPE(MPI_Comm)		9
MPI_DATATYPE_NULL	MPI::DATATYPE_NULL	10
MPI_Datatype / INTEGER	const MPI::Datatype	11
[ticket231-C.] or TYPE(MPI_Datatype)		12
MPI_REQUEST_NULL	MPI::REQUEST_NULL	13
MPI_Request / INTEGER	const MPI::Request	14
[ticket231-C.] or TYPE(MPI_Request)		15
MPI_OP_NULL	MPI::OP_NULL	16
MPI_Op / INTEGER	const MPI::Op	17
[ticket231-C.] or TYPE(MPI_Op)		18
MPI_ERRHANDLER_NULL	MPI::ERRHANDLER_NULL	19
MPI_Errhandler / INTEGER	const MPI::Errhandler	20
[ticket231-C.] or TYPE(MPI_Errhandler)		21
MPI_FILE_NULL	MPI::FILE_NULL	22
MPI_File / INTEGER		23
[ticket231-C.] or TYPE(MPI_File)		24
MPI_INFO_NULL	MPI::INFO_NULL	25
MPI_Info / INTEGER	const MPI::Info	26
[ticket231-C.] or TYPE(MPI_Info)		27
MPI_WIN_NULL	MPI::WIN_NULL	28
MPI_Win / INTEGER		29
[ticket231-C.] or TYPE(MPI_Win)		30
[ticket274.]MPI_MESSAGE_NULL	[ticket274.]Not defined for C++	31
[ticket274.] MPI_Message / INTEGER		32
[ticket231-C.] or TYPE(MPI_Message)		33
¹⁾ C++ type: See Section 16.1.7 on page 638 regarding		34
class hierarchy and the specific type of MPI::COMM_NULL		35
		36
		37
Empty group		38
C type: MPI_Group	C++ type: const MPI::Group	39
Fortran type: INTEGER		40
[ticket231-C.] or TYPE(MPI_Group)		41
MPI_GROUP_EMPTY	MPI::GROUP_EMPTY	42
		43
		44
		45
		46
		47
		48

Topologies

C type: <code>const int</code> (or unnamed <code>enum</code>)	C++ type: <code>const int</code> (or unnamed <code>enum</code>)
Fortran type: <code>INTEGER</code>	
<code>MPI_GRAPH</code>	<code>MPI::GRAPH</code>
<code>MPI_CART</code>	<code>MPI::CART</code>
<code>MPI_DIST_GRAPH</code>	<code>MPI::DIST_GRAPH</code>

1
2
3
4
5
6
7
8
9
10
11
12
13
14
15
16
17
18
19
20
21
22
23
24
25
26
27
28
29
30
31
32
33
34
35
36
37
38
39
40
41
42
43
44
45
46
47
48

Predefined functions		1
C/Fortran name	C++ name	2
C type / Fortran type [ticket230-B.]with <code>mpi</code> module	C++ type	3
[ticket230-B.]/ Fortran type with <code>mpi_f08</code> module		4
		5
MPI_COMM_NULL_COPY_FN	MPI_COMM_NULL_COPY_FN	6
MPI_Comm_copy_attr_function	same as in C ¹⁾	7
/ COMM_COPY_ATTR_[ticket250-V.] [FN] FUNCTION		8
/ [ticket230-B.]PROCEDURE(MPI_Comm_copy_attr_function) ²⁾		9
MPI_COMM_DUP_FN	MPI_COMM_DUP_FN	10
MPI_Comm_copy_attr_function	same as in C ¹⁾	11
/ COMM_COPY_ATTR_[ticket250-V.] [FN] FUNCTION		12
/ [ticket230-B.]PROCEDURE(MPI_Comm_copy_attr_function) ²⁾		13
MPI_COMM_NULL_DELETE_FN	MPI_COMM_NULL_DELETE_FN	14
MPI_Comm_delete_attr_function	same as in C ¹⁾	15
/ COMM_DELETE_ATTR_[ticket250-V.] [FN] FUNCTION		16
/ [ticket230-B.]PROCEDURE(MPI_Comm_delete_attr_function) ²⁾		17
MPI_WIN_NULL_COPY_FN	MPI_WIN_NULL_COPY_FN	18
MPI_Win_copy_attr_function	same as in C ¹⁾	19
/ WIN_COPY_ATTR_[ticket250-V.] [FN] FUNCTION		20
/ [ticket230-B.]PROCEDURE(MPI_Win_copy_attr_function) ²⁾		21
MPI_WIN_DUP_FN	MPI_WIN_DUP_FN	22
MPI_Win_copy_attr_function	same as in C ¹⁾	23
/ WIN_COPY_ATTR_[ticket250-V.] [FN] FUNCTION		24
/ [ticket230-B.]PROCEDURE(MPI_Win_copy_attr_function) ²⁾		25
MPI_WIN_NULL_DELETE_FN	MPI_WIN_NULL_DELETE_FN	26
MPI_Win_delete_attr_function	same as in C ¹⁾	27
/ WIN_DELETE_ATTR_[ticket250-V.] [FN] FUNCTION		28
/ [ticket230-B.]PROCEDURE(MPI_Win_delete_attr_function) ²⁾		29
MPI_TYPE_NULL_COPY_FN	MPI_TYPE_NULL_COPY_FN	30
MPI_Type_copy_attr_function	same as in C ¹⁾	31
/ TYPE_COPY_ATTR_[ticket250-V.] [FN] FUNCTION		32
/ [ticket230-B.]PROCEDURE(MPI_Type_copy_attr_function) ²⁾		33
MPI_TYPE_DUP_FN	MPI_TYPE_DUP_FN	34
MPI_Type_copy_attr_function	same as in C ¹⁾	35
/ TYPE_COPY_ATTR_[ticket250-V.] [FN] FUNCTION		36
/ [ticket230-B.]PROCEDURE(MPI_Type_copy_attr_function) ²⁾		37
MPI_TYPE_NULL_DELETE_FN	MPI_TYPE_NULL_DELETE_FN	38
MPI_Type_delete_attr_function	same as in C ¹⁾	39
/ TYPE_DELETE_ATTR_[ticket250-V.] [FN] FUNCTION		40
/ [ticket230-B.]PROCEDURE(MPI_Type_delete_attr_function) ²⁾		41
¹ See the advice to implementors [ticket230-B.](on page 282) and advice to users (on page 282)		42
on [ticket230-B.]the predefined C functions MPI_COMM_NULL_COPY_FN, ... in		43
Section 6.7.2 on page 279		44
[ticket230-B.] ² See the advice to implementors (on page 282) and advice to users (on page 282)		45
[ticket230-B.] on the predefined Fortran functions MPI_COMM_NULL_COPY_FN, ... in		46
[ticket230-B.] Section 6.7.2 on page 279		47
		48

Deprecated predefined functions

C/Fortran name	C++ name
C type / Fortran type	C++ type
MPI_NULL_COPY_FN	MPI::NULL_COPY_FN
MPI_Copy_function / COPY_FUNCTION	MPI::Copy_function
MPI_DUP_FN	MPI::DUP_FN
MPI_Copy_function / COPY_FUNCTION	MPI::Copy_function
MPI_NULL_DELETE_FN	MPI::NULL_DELETE_FN
MPI_Delete_function / DELETE_FUNCTION	MPI::Delete_function

Predefined Attribute Keys

C type: <code>const int</code> (or unnamed <code>enum</code>)	C++ type:
Fortran type: <code>INTEGER</code>	<code>const int</code> (or unnamed <code>enum</code>)
MPI_APPNUM	MPI::APPNUM
MPI_LASTUSED_CODE	MPI::LASTUSED_CODE
MPI_UNIVERSE_SIZE	MPI::UNIVERSE_SIZE
MPI_WIN_BASE	MPI::WIN_BASE
MPI_WIN_DISP_UNIT	MPI::WIN_DISP_UNIT
MPI_WIN_SIZE	MPI::WIN_SIZE
[ticket270.]MPI_WIN_CREATE_FLAVOR	[ticket270.]Not defined for C++
[ticket270.]MPI_WIN_MODEL	[ticket270.]Not defined for C++

ticket270.

MPI Window Create FlavorsC type: `const int` (or unnamed `enum`)Fortran type: `INTEGER`

MPI_WIN_FLAVOR_CREATE

MPI_WIN_FLAVOR_ALLOCATE

MPI_WIN_FLAVOR_DYNAMIC

[ticket284.]MPI_WIN_FLAVOR_SHARED

ticket270.

MPI Window ModelsC type: `const int` (or unnamed `enum`)Fortran type: `INTEGER`

MPI_WIN_SEPARATE

MPI_WIN_UNIFIED

Mode Constants

C type: <code>const int</code> (or unnamed <code>enum</code>)	C++ type:	
Fortran type: <code>INTEGER</code>	<code>const int</code> (or unnamed <code>enum</code>)	
<code>MPI_MODE_APPEND</code>	<code>MPI::MODE_APPEND</code>	1
<code>MPI_MODE_CREATE</code>	<code>MPI::MODE_CREATE</code>	2
<code>MPI_MODE_DELETE_ON_CLOSE</code>	<code>MPI::MODE_DELETE_ON_CLOSE</code>	3
<code>MPI_MODE_EXCL</code>	<code>MPI::MODE_EXCL</code>	4
<code>MPI_MODE_NOCHECK</code>	<code>MPI::MODE_NOCHECK</code>	5
<code>MPI_MODE_NOPRECEDE</code>	<code>MPI::MODE_NOPRECEDE</code>	6
<code>MPI_MODE_NOPUT</code>	<code>MPI::MODE_NOPUT</code>	7
<code>MPI_MODE_NOSTORE</code>	<code>MPI::MODE_NOSTORE</code>	8
<code>MPI_MODE_NOSUCCEED</code>	<code>MPI::MODE_NOSUCCEED</code>	9
<code>MPI_MODE_RDONLY</code>	<code>MPI::MODE_RDONLY</code>	10
<code>MPI_MODE_RDWR</code>	<code>MPI::MODE_RDWR</code>	11
<code>MPI_MODE_SEQUENTIAL</code>	<code>MPI::MODE_SEQUENTIAL</code>	12
<code>MPI_MODE_UNIQUE_OPEN</code>	<code>MPI::MODE_UNIQUE_OPEN</code>	13
<code>MPI_MODE_WRONLY</code>	<code>MPI::MODE_WRONLY</code>	14

Datatype Decoding Constants

C type: <code>const int</code> (or unnamed <code>enum</code>)	C++ type:	
Fortran type: <code>INTEGER</code>	<code>const int</code> (or unnamed <code>enum</code>)	
<code>MPI_COMBINER_CONTIGUOUS</code>	<code>MPI::COMBINER_CONTIGUOUS</code>	15
<code>MPI_COMBINER_DARRAY</code>	<code>MPI::COMBINER_DARRAY</code>	16
<code>MPI_COMBINER_DUP</code>	<code>MPI::COMBINER_DUP</code>	17
<code>MPI_COMBINER_F90_COMPLEX</code>	<code>MPI::COMBINER_F90_COMPLEX</code>	18
<code>MPI_COMBINER_F90_INTEGER</code>	<code>MPI::COMBINER_F90_INTEGER</code>	19
<code>MPI_COMBINER_F90_REAL</code>	<code>MPI::COMBINER_F90_REAL</code>	20
<code>MPI_COMBINER_HINDEXED_INTEGER</code>	<code>MPI::COMBINER_HINDEXED_INTEGER</code>	21
<code>MPI_COMBINER_HINDEXED</code>	<code>MPI::COMBINER_HINDEXED</code>	22
<code>MPI_COMBINER_HVECTOR_INTEGER</code>	<code>MPI::COMBINER_HVECTOR_INTEGER</code>	23
<code>MPI_COMBINER_HVECTOR</code>	<code>MPI::COMBINER_HVECTOR</code>	24
<code>MPI_COMBINER_INDEXED_BLOCK</code>	<code>MPI::COMBINER_INDEXED_BLOCK</code>	25
[ticket280.] <code>MPI_COMBINER_HINDEXED_BLOCK</code>		26
<code>MPI_COMBINER_INDEXED</code>	<code>MPI::COMBINER_INDEXED</code>	27
<code>MPI_COMBINER_NAMED</code>	<code>MPI::COMBINER_NAMED</code>	28
<code>MPI_COMBINER_RESIZED</code>	<code>MPI::COMBINER_RESIZED</code>	29
<code>MPI_COMBINER_STRUCT_INTEGER</code>	<code>MPI::COMBINER_STRUCT_INTEGER</code>	30
<code>MPI_COMBINER_STRUCT</code>	<code>MPI::COMBINER_STRUCT</code>	31
<code>MPI_COMBINER_SUBARRAY</code>	<code>MPI::COMBINER_SUBARRAY</code>	32
<code>MPI_COMBINER_VECTOR</code>	<code>MPI::COMBINER_VECTOR</code>	33

Threads Constants

C type: <code>const int</code> (or unnamed <code>enum</code>)	C++ type:
Fortran type: <code>INTEGER</code>	<code>const int</code> (or unnamed <code>enum</code>)
<code>MPI_THREAD_FUNNELED</code>	<code>MPI::THREAD_FUNNELED</code>
<code>MPI_THREAD_MULTIPLE</code>	<code>MPI::THREAD_MULTIPLE</code>
<code>MPI_THREAD_SERIALIZED</code>	<code>MPI::THREAD_SERIALIZED</code>
<code>MPI_THREAD_SINGLE</code>	<code>MPI::THREAD_SINGLE</code>

File Operation Constants, Part 1

C type: <code>const MPI_Offset</code> (or unnamed <code>enum</code>)	C++ type:
Fortran type: <code>INTEGER (KIND=MPI_OFFSET_KIND)</code>	<code>const MPI::Offset</code> (or unnamed <code>enum</code>)
<code>MPI_DISPLACEMENT_CURRENT</code>	<code>MPI::DISPLACEMENT_CURRENT</code>

File Operation Constants, Part 2

C type: <code>const int</code> (or unnamed <code>enum</code>)	C++ type:
Fortran type: <code>INTEGER</code>	<code>const int</code> (or unnamed <code>enum</code>)
<code>MPI_DISTRIBUTE_BLOCK</code>	<code>MPI::DISTRIBUTE_BLOCK</code>
<code>MPI_DISTRIBUTE_CYCLIC</code>	<code>MPI::DISTRIBUTE_CYCLIC</code>
<code>MPI_DISTRIBUTE_DFLT_DARG</code>	<code>MPI::DISTRIBUTE_DFLT_DARG</code>
<code>MPI_DISTRIBUTE_NONE</code>	<code>MPI::DISTRIBUTE_NONE</code>
<code>MPI_ORDER_C</code>	<code>MPI::ORDER_C</code>
<code>MPI_ORDER_FORTRAN</code>	<code>MPI::ORDER_FORTRAN</code>
<code>MPI_SEEK_CUR</code>	<code>MPI::SEEK_CUR</code>
<code>MPI_SEEK_END</code>	<code>MPI::SEEK_END</code>
<code>MPI_SEEK_SET</code>	<code>MPI::SEEK_SET</code>

F90 Datatype Matching Constants

C type: <code>const int</code> (or unnamed <code>enum</code>)	C++ type:
Fortran type: <code>INTEGER</code>	<code>const int</code> (or unnamed <code>enum</code>)
<code>MPI_TYPECLASS_COMPLEX</code>	<code>MPI::TYPECLASS_COMPLEX</code>
<code>MPI_TYPECLASS_INTEGER</code>	<code>MPI::TYPECLASS_INTEGER</code>
<code>MPI_TYPECLASS_REAL</code>	<code>MPI::TYPECLASS_REAL</code>

Constants Specifying Empty or Ignored Input		1
C/Fortran name	C++ name	2
C type / Fortran type	C++ type	3
MPI_ARGVS_NULL	MPI::ARGVS_NULL	4
char*** / 2-dim. array of CHARACTER*(*)	const char ***	5
MPI_ARGV_NULL	MPI::ARGV_NULL	6
char** / array of CHARACTER*(*)	const char **	7
MPI_ERRCODES_IGNORE	Not defined for C++	8
int* / INTEGER array		9
MPI_STATUSES_IGNORE	Not defined for C++	10
MPI_Status* / INTEGER, DIMENSION(MPI_STATUS_SIZE,*)		11
[ticket231-C.] or TYPE(MPI_Status), DIMENSION(*)		12
MPI_STATUS_IGNORE	Not defined for C++	13
MPI_Status* / INTEGER, DIMENSION(MPI_STATUS_SIZE)		14
[ticket231-C.] or TYPE(MPI_Status)		15
MPI_UNWEIGHTED	Not defined for C++	16
[ticket0.172.] int* / INTEGER array		17
		18
		19
C Constants Specifying Ignored Input (no C++ or Fortran)		20
C type: MPI_Fint*	[ticket243-O.] equivalent to Fortran	21
MPI_F_STATUSES_IGNORE	[ticket243-O.] MPI_STATUSES_IGNORE in mpi / mpif.h	22
MPI_F_STATUS_IGNORE	[ticket243-O.] MPI_STATUS_IGNORE in mpi / mpif.h	23
[ticket243-O.] C type: MPI_F08_status*	[ticket243-O.] equivalent to Fortran	24
[ticket243-O.] MPI_F08_STATUSES_IGNORE	[ticket243-O.] MPI_STATUSES_IGNORE in mpi_f08	25
[ticket243-O.] MPI_F08_STATUS_IGNORE	[ticket243-O.] MPI_STATUS_IGNORE in mpi_f08	26
		27
		28
C and C++ preprocessor Constants and Fortran Parameters		29
C/C++ type: const int (or unnamed enum)		30
Fortran type: INTEGER		31
MPI_SUBVERSION		32
MPI_VERSION		33
		34
		35
		36
Null handles used in the MPI tool information interface		37
MPI_T_ENUM_NULL		38
MPI_T_CVAR_HANDLE_NULL		39
MPI_T_PVAR_HANDLE_NULL		40
MPI_T_PVAR_SESSION_NULL		41
		42
		43
		44
		45
		46
		47
		48

ticket266.

Verbosity Levels in the MPI tool information interface

MPI_T_VERBOSITY_USER_BASIC
MPI_T_VERBOSITY_USER_DETAIL
MPI_T_VERBOSITY_USER_ALL
MPI_T_VERBOSITY_TUNER_BASIC
MPI_T_VERBOSITY_TUNER_DETAIL
MPI_T_VERBOSITY_TUNER_ALL
MPI_T_VERBOSITY_MPIDEV_BASIC
MPI_T_VERBOSITY_MPIDEV_DETAIL
MPI_T_VERBOSITY_MPIDEV_ALL

**Constants to identify associations of variables
in the MPI tool information interface**

MPI_T_BIND_NO_OBJECT
MPI_T_BIND_MPI_COMM
MPI_T_BIND_MPI_DATATYPE
MPI_T_BIND_MPI_ERRHANDLER
MPI_T_BIND_MPI_FILE
MPI_T_BIND_MPI_GROUP
MPI_T_BIND_MPI_OP
MPI_T_BIND_MPI_REQUEST
MPI_T_BIND_MPI_WIN
MPI_T_BIND_MPI_MESSAGE
MPI_T_BIND_MPI_INFO

**Constants describing the scope of a control variable
in the MPI tool information interface**

MPI_T_SCOPE_READONLY
MPI_T_SCOPE_LOCAL
MPI_T_SCOPE_GROUP
MPI_T_SCOPE_GROUP_EQ
MPI_T_SCOPE_GLOBAL
MPI_T_SCOPE_GLOBAL_EQ

**Additional constants used
by the MPI tool information interface**

MPI_T_PVAR_ALL_HANDLES

**Performance variables classes used by the
MPI tool information interface**

MPI_T_PVAR_CLASS_STATE

MPI_T_PVAR_CLASS_LEVEL

MPI_T_PVAR_CLASS_SIZE

MPI_T_PVAR_CLASS_PERCENTAGE

MPI_T_PVAR_CLASS_HIGHWATERMARK

MPI_T_PVAR_CLASS_LOWWATERMARK

MPI_T_PVAR_CLASS_COUNTER

MPI_T_PVAR_CLASS_AGGREGATE

MPI_T_PVAR_CLASS_TIMER

MPI_T_PVAR_CLASS_GENERIC

A.1.2 Types

The following are defined C type definitions, included in the file `mpi.h`.

```
/* C opaque types */
```

MPI_Aint

MPI_Count

MPI_Fint

MPI_Offset

MPI_Status

MPI_F08_status

```
/* C handles to assorted structures */
```

MPI_Comm

MPI_Datatype

MPI_Errhandler

MPI_File

MPI_Group

MPI_Info

MPI_Message

MPI_Op

MPI_Request

MPI_Win

```
/* Types for the MPI_T interface */
```

MPI_T_enum

MPI_T_cvar_handle

MPI_T_pvar_handle

MPI_T_pvar_session

```
// C++ opaque types (all within the MPI namespace)
```

MPI::Aint

MPI::Offset

MPI::Status

```

1
2 // C++ handles to assorted structures (classes,
3 // all within the MPI namespace)
4 MPI::Comm
5 MPI::Intracomm
6 MPI::Graphcomm
7 MPI::Distgraphcomm
8 MPI::Cartcomm
9 MPI::Intercomm
10 MPI::Datatype
11 MPI::Errhandler
12 MPI::Exception
13 MPI::File
14 MPI::Group
15 MPI::Info
16 MPI::Op
17 MPI::Request
18 MPI::Prequest
19 MPI::Grequest
20 MPI::Win

```

ticket243-O.

The following are defined Fortran type definitions, included in the `mpi_f08` and `mpi` module.

```

24 ! Fortran opaque types in the mpi_f08 and mpi module
25 TYPE(MPI_Status)
26

```

ticket231-C.

```

27 ! Fortran handles in the mpi_f08 and mpi module
28 TYPE(MPI_Comm)
29 TYPE(MPI_Datatype)
30 TYPE(MPI_Errhandler)
31 TYPE(MPI_File)
32 TYPE(MPI_Group)
33 TYPE(MPI_Info)
34 TYPE(MPI_Op)
35 TYPE(MPI_Request)
36 TYPE(MPI_Win)
37

```

ticket0. A.1.3 Prototype [d]Definitions

ticket230-B.

C Bindings

The following are defined C typedefs for user-defined functions, also included in the file `mpi.h`.

```

44 /* prototypes for user-defined functions */
45 typedef void MPI_User_function(void *invec, void *inoutvec, int *len,
46                               MPI_Datatype *datatype);
47
48

```

```

typedef int MPI_Comm_copy_attr_function(MPI_Comm oldcomm,
    int comm_keyval, void *extra_state, void *attribute_val_in,
    void *attribute_val_out, int*flag);
typedef int MPI_Comm_delete_attr_function(MPI_Comm comm,
    int comm_keyval, void *attribute_val, void *extra_state);

typedef int MPI_Win_copy_attr_function(MPI_Win oldwin, int win_keyval,
    void *extra_state, void *attribute_val_in,
    void *attribute_val_out, int *flag);
typedef int MPI_Win_delete_attr_function(MPI_Win win, int win_keyval,
    void *attribute_val, void *extra_state);

typedef int MPI_Type_copy_attr_function(MPI_Datatype oldtype,
    int type_keyval, void *extra_state,
    void *attribute_val_in, void *attribute_val_out, int *flag);
typedef int MPI_Type_delete_attr_function(MPI_Datatype [ticket252-W.]datatype,
    int type_keyval, void *attribute_val, void *extra_state);

typedef void MPI_Comm_errhandler_function(MPI_Comm *, int *, ...);
typedef void MPI_Win_errhandler_function(MPI_Win *, int *, ...);
typedef void MPI_File_errhandler_function(MPI_File *, int *, ...);

typedef int MPI_Grequest_query_function(void *extra_state,
    MPI_Status *status);
typedef int MPI_Grequest_free_function(void *extra_state);
typedef int MPI_Grequest_cancel_function(void *extra_state, int complete);

typedef int MPI_Datarep_extent_function(MPI_Datatype datatype,
    MPI_Aint *file_extent, void *extra_state);
typedef int MPI_Datarep_conversion_function(void *userbuf,
    MPI_Datatype datatype, int count, void *filebuf,
    MPI_Offset position, void *extra_state);

```

Fortran 2008 Bindings with the mpi_f08 Module

With the Fortran `mpi_f08` module, the callback prototypes are:

The user-function argument to `MPI_Op_create` should be declared according to:

ABSTRACT INTERFACE

```

SUBROUTINE MPI_User_function(invec, inoutvec, len, datatype) BIND(C)
    USE, INTRINSIC :: ISO_C_BINDING, ONLY : C_PTR
    TYPE(C_PTR), VALUE :: invec, inoutvec
    INTEGER :: len
    TYPE(MPI_Datatype) :: datatype

```

The copy and delete function arguments to `MPI_Comm_create_keyval` should be declared according to:

ABSTRACT INTERFACE

```

1      SUBROUTINE MPI_Comm_copy_attr_function(oldcomm, comm_keyval, extra_state,
2      attribute_val_in, attribute_val_out, flag, ierror) BIND(C)
3          TYPE(MPI_Comm) :: oldcomm
4          INTEGER :: comm_keyval, ierror
5          INTEGER(KIND=MPI_ADDRESS_KIND) :: extra_state, attribute_val_in,
6          attribute_val_out
7          LOGICAL :: flag

```

ticket-248T.

ABSTRACT INTERFACE

```

9      SUBROUTINE MPI_Comm_delete_attr_function(comm, comm_keyval,
10     attribute_val, extra_state, ierror) BIND(C)
11          TYPE(MPI_Comm) :: comm
12          INTEGER :: comm_keyval, ierror
13          INTEGER(KIND=MPI_ADDRESS_KIND) :: attribute_val, extra_state

```

ticket230-B.

The copy and delete function arguments to MPI_Win_create_keyval should be declared according to:

ticket-248T.

ABSTRACT INTERFACE

```

17     SUBROUTINE MPI_Win_copy_attr_function(oldwin, win_keyval, extra_state,
18     attribute_val_in, attribute_val_out, flag, ierror) BIND(C)
19         TYPE(MPI_Win) :: oldwin
20         INTEGER :: win_keyval, ierror
21         INTEGER(KIND=MPI_ADDRESS_KIND) :: extra_state, attribute_val_in,
22         attribute_val_out
23         LOGICAL :: flag

```

ticket-248T.

ABSTRACT INTERFACE

```

26     SUBROUTINE MPI_Win_delete_attr_function(win, win_keyval, attribute_val,
27     extra_state, ierror) BIND(C)
28         TYPE(MPI_Win) :: win
29         INTEGER :: win_keyval, ierror
30         INTEGER(KIND=MPI_ADDRESS_KIND) :: attribute_val, extra_state

```

ticket230-B.

The copy and delete function arguments to MPI_Type_create_keyval should be declared according to:

ticket-248T.

ABSTRACT INTERFACE

```

35     SUBROUTINE MPI_Type_copy_attr_function(oldtype, type_keyval, extra_state,
36     attribute_val_in, attribute_val_out, flag, ierror) BIND(C)
37         TYPE(MPI_Datatype) :: oldtype
38         INTEGER :: type_keyval, ierror
39         INTEGER(KIND=MPI_ADDRESS_KIND) :: extra_state, attribute_val_in,
40         attribute_val_out
41         LOGICAL :: flag

```

ticket-248T.

ABSTRACT INTERFACE

```

44     SUBROUTINE MPI_Type_delete_attr_function(datatype, type_keyval,
45     attribute_val, extra_state, ierror) BIND(C)
46         TYPE(MPI_Datatype) :: datatype
47         INTEGER :: type_keyval, ierror
48         INTEGER(KIND=MPI_ADDRESS_KIND) :: attribute_val, extra_state

```

The handler-function argument to `MPI_Comm_create_errhandler` should be declared like this:

```
ABSTRACT INTERFACE
```

```
  SUBROUTINE MPI_Comm_errhandler_function(comm, error_code) BIND(C)
    TYPE(MPI_Comm) :: comm
    INTEGER :: error_code
```

The handler-function argument to `MPI_Win_create_errhandler` should be declared like this:

```
ABSTRACT INTERFACE
```

```
  SUBROUTINE MPI_Win_errhandler_function(win, error_code) BIND(C)
    TYPE(MPI_Win) :: win
    INTEGER :: error_code
```

The handler-function argument to `MPI_File_create_errhandler` should be declared like this:

```
ABSTRACT INTERFACE
```

```
  SUBROUTINE MPI_File_errhandler_function(file, error_code) BIND(C)
    TYPE(MPI_File) :: file
    INTEGER :: error_code
```

The query, free, and cancel function arguments to `MPI_Grequest_start` should be declared according to:

```
ABSTRACT INTERFACE
```

```
  SUBROUTINE MPI_Grequest_query_function(extra_state, status, ierror)
    BIND(C)
    TYPE(MPI_Status) :: status
    INTEGER :: ierror
    INTEGER(KIND=MPI_ADDRESS_KIND) :: extra_state
```

```
ABSTRACT INTERFACE
```

```
  SUBROUTINE MPI_Grequest_free_function(extra_state, ierror) BIND(C)
    INTEGER :: ierror
    INTEGER(KIND=MPI_ADDRESS_KIND) :: extra_state
```

```
ABSTRACT INTERFACE
```

```
  SUBROUTINE MPI_Grequest_cancel_function(extra_state, complete, ierror)
    BIND(C)
    INTEGER :: ierror
    INTEGER(KIND=MPI_ADDRESS_KIND) :: extra_state
    LOGICAL :: complete
```

The extend and conversion function arguments to `MPI_Register_datarep` should be declared according to:

```
ABSTRACT INTERFACE
```

```
  SUBROUTINE MPI_Datarep_extent_function(datatype, extent, extra_state,
    ierror) BIND(C)
    TYPE(MPI_Datatype) :: datatype
    INTEGER(KIND=MPI_ADDRESS_KIND) :: extent, extra_state
```

1
2 ticket230-B.
3 ticket-248T.
4
5
6
7
8 ticket230-B.
9
10 ticket-248T.
11
12
13
14 ticket230-B.
15
16 ticket-248T.
17
18
19
20
21 ticket230-B.
22
23 ticket-248T.
24
25
26
27
28
29 ticket-248T.
30
31
32
33
34 ticket-248T.
35
36
37
38
39
40
41 ticket230-B.
42 ticket229.1.
43 ticket-248T.
44
45
46
47
48

```

1         INTEGER :: ierror
ticket-248T. 2
3     ABSTRACT INTERFACE
4         SUBROUTINE MPI_Datarep_conversion_function(userbuf, datatype, count,
5         filebuf, position, extra_state, ierror) BIND(C)
6         USE, INTRINSIC :: ISO_C_BINDING, ONLY : C_PTR
7         TYPE(C_PTR), VALUE :: userbuf, filebuf
8         TYPE(MPI_Datatype) :: datatype
9         INTEGER :: count, ierror
10        INTEGER(KIND=MPI_OFFSET_KIND) :: position
ticket230-B. 11        INTEGER(KIND=MPI_ADDRESS_KIND) :: extra_state

```

Fortran Bindings with mpif.h or the mpi Module

[For Fortran]With the Fortran `mpi` module or `mpif.h`, here are examples of how each of the user-defined subroutines should be declared.

The user-function argument to `MPI_OP_CREATE` should be declared like this:

```

17 SUBROUTINE USER_FUNCTION(INVEC, INOUTVEC, LEN, [ticket252-W.]DATATYPE)
18     <type> INVEC(LEN), INOUTVEC(LEN)
19     INTEGER LEN, [ticket252-W.]DATATYPE

```

The copy and delete function arguments to `MPI_COMM_CREATE_KEYVAL` should be declared like these:

```

23 SUBROUTINE COMM_COPY_ATTR_[ticket250-V.] [FN]FUNCTION(OLDCOMM, COMM_KEYVAL, EXTRA_STATE,
24     ATTRIBUTE_VAL_IN, ATTRIBUTE_VAL_OUT, FLAG, IERROR)
25     INTEGER OLDCOMM, COMM_KEYVAL, IERROR
26     INTEGER(KIND=MPI_ADDRESS_KIND) EXTRA_STATE, ATTRIBUTE_VAL_IN,
27     ATTRIBUTE_VAL_OUT
28     LOGICAL FLAG
29
30 SUBROUTINE COMM_DELETE_ATTR_[ticket250-V.] [FN]FUNCTION(COMM, COMM_KEYVAL, ATTRIBUTE_VAL,
31     EXTRA_STATE, IERROR)
32     INTEGER COMM, COMM_KEYVAL, IERROR
33     INTEGER(KIND=MPI_ADDRESS_KIND) ATTRIBUTE_VAL, EXTRA_STATE
34

```

The copy and delete function arguments to `MPI_WIN_CREATE_KEYVAL` should be declared like these:

```

38 SUBROUTINE WIN_COPY_ATTR_[ticket250-V.] [FN]FUNCTION(OLDWIN, WIN_KEYVAL, EXTRA_STATE,
39     ATTRIBUTE_VAL_IN, ATTRIBUTE_VAL_OUT, FLAG, IERROR)
40     INTEGER OLDWIN, WIN_KEYVAL, IERROR
41     INTEGER(KIND=MPI_ADDRESS_KIND) EXTRA_STATE, ATTRIBUTE_VAL_IN,
42     ATTRIBUTE_VAL_OUT
43     LOGICAL FLAG
44
45 SUBROUTINE WIN_DELETE_ATTR_[ticket250-V.] [FN]FUNCTION(WIN, WIN_KEYVAL, ATTRIBUTE_VAL,
46     EXTRA_STATE, IERROR)
47     INTEGER WIN, WIN_KEYVAL, IERROR
48     INTEGER(KIND=MPI_ADDRESS_KIND) ATTRIBUTE_VAL, EXTRA_STATE

```

The copy and delete function arguments to MPI_TYPE_CREATE_KEYVAL should be declared like these:

```

1
2
3
SUBROUTINE TYPE_COPY_ATTR_[ticket250-V.] [FN]FUNCTION(OLDTYPE, TYPE_KEYVAL, EXTRA_STATE,
4
5     ATTRIBUTE_VAL_IN, ATTRIBUTE_VAL_OUT, FLAG, IERROR)
6
7     INTEGER OLDTYPE, TYPE_KEYVAL, IERROR
8
9     INTEGER(KIND=MPI_ADDRESS_KIND) EXTRA_STATE,
10
11     ATTRIBUTE_VAL_IN, ATTRIBUTE_VAL_OUT
12
13     LOGICAL FLAG
14
15
16
SUBROUTINE TYPE_DELETE_ATTR_[ticket250-V.] [FN]FUNCTION([ticket252-W.]DATATYPE, TYPE_KEYVAL,
17
18     EXTRA_STATE, IERROR)
19
20     INTEGER [ticket252-W.]DATATYPE, TYPE_KEYVAL, IERROR
21
22     INTEGER(KIND=MPI_ADDRESS_KIND) ATTRIBUTE_VAL, EXTRA_STATE
23
24
25

```

The handler-function argument to MPI_COMM_CREATE_ERRHANDLER should be declared like this:

```

18
19
20
SUBROUTINE COMM_ERRHANDLER_FUNCTION(COMM, ERROR_CODE)
21
22     INTEGER COMM, ERROR_CODE
23
24

```

The handler-function argument to MPI_WIN_CREATE_ERRHANDLER should be declared like this:

```

24
25
26
SUBROUTINE WIN_ERRHANDLER_FUNCTION(WIN, ERROR_CODE)
27
28     INTEGER WIN, ERROR_CODE
29
30

```

The handler-function argument to MPI_FILE_CREATE_ERRHANDLER should be declared like this:

```

30
31
32
SUBROUTINE FILE_ERRHANDLER_FUNCTION(FILE, ERROR_CODE)
33
34     INTEGER FILE, ERROR_CODE
35
36

```

The query, free, and cancel function arguments to MPI_GREQUEST_START should be declared like these:

```

36
37
38
SUBROUTINE GREQUEST_QUERY_FUNCTION(EXTRA_STATE, STATUS, IERROR)
39
40     INTEGER STATUS(MPI_STATUS_SIZE), IERROR
41
42     INTEGER(KIND=MPI_ADDRESS_KIND) EXTRA_STATE
43
44
45
SUBROUTINE GREQUEST_FREE_FUNCTION(EXTRA_STATE, IERROR)
46
47     INTEGER IERROR
48
49     INTEGER(KIND=MPI_ADDRESS_KIND) EXTRA_STATE
50
51
52
SUBROUTINE GREQUEST_CANCEL_FUNCTION(EXTRA_STATE, COMPLETE, IERROR)
53
54     INTEGER IERROR
55
56     INTEGER(KIND=MPI_ADDRESS_KIND) EXTRA_STATE
57
58     LOGICAL COMPLETE
59
60

```

1 The extend and conversion function arguments to MPI_REGISTER_DATAREP should
2 be declared like these:

```
3
4 SUBROUTINE DATAREP_EXTENT_FUNCTION(DATATYPE, EXTENT, EXTRA_STATE, IERROR)
5     INTEGER DATATYPE, IERROR
6     INTEGER(KIND=MPI_ADDRESS_KIND) EXTENT, EXTRA_STATE
```

```
7
8 SUBROUTINE DATAREP_CONVERSION_FUNCTION(USERBUF, DATATYPE, COUNT, FILEBUF,
9     POSITION, EXTRA_STATE, IERROR)
10    <TYPE> USERBUF(*), FILEBUF(*)
11    INTEGER COUNT, DATATYPE, IERROR
12    INTEGER(KIND=MPI_OFFSET_KIND) POSITION
13    INTEGER(KIND=MPI_ADDRESS_KIND) EXTRA_STATE
```

ticket230-B.

15 C++ Bindings (deprecated)

ticket185. 17 The following are **deprecated** defined C++ typedefs, also included in the file `mpi.h`.
18 namespace MPI {

```
19     typedef void User_function(const void* invec, void *inoutvec,
20         int len, const Datatype& datatype);
```

```
21
22     typedef int Comm::Copy_attr_function(const Comm& oldcomm,
23         int comm_keyval, void* extra_state, void* attribute_val_in,
24         void* attribute_val_out, bool& flag);
```

```
25     typedef int Comm::Delete_attr_function(Comm& comm, int
26         comm_keyval, void* attribute_val, void* extra_state);
```

```
27
28     typedef int Win::Copy_attr_function(const Win& oldwin,
29         int win_keyval, void* extra_state, void* attribute_val_in,
30         void* attribute_val_out, bool& flag);
```

```
31     typedef int Win::Delete_attr_function(Win& win, int
32         win_keyval, void* attribute_val, void* extra_state);
```

```
33
34     typedef int Datatype::Copy_attr_function(const Datatype& oldtype,
35         int type_keyval, void* extra_state,
36         const void* attribute_val_in, void* attribute_val_out,
37         bool& flag);
```

```
38     typedef int Datatype::Delete_attr_function(Datatype& [ticket3.] .0){252-W}{data}type,
39         int type_keyval, void* attribute_val, void* extra_state);
```

```
40
41     typedef void Comm::Errhandler_function(Comm &, int *, ...);
```

```
42     typedef void Win::Errhandler_function(Win &, int *, ...);
```

```
43     typedef void File::Errhandler_function(File &, int *, ...);
```

```
44
45     typedef int Grequest::Query_function(void* extra_state, Status& status);
```

```
46     typedef int Grequest::Free_function(void* extra_state);
```

```
47     typedef int Grequest::Cancel_function(void* extra_state, bool complete);
```

48

```

typedef void Datarep_extent_function(const Datatype& datatype,
                                     Aint& file_extent, void* extra_state);
typedef void Datarep_conversion_function(void* userbuf,
                                         Datatype& datatype, int count, void* filebuf,
                                         Offset position, void* extra_state);
}

```

A.1.4 Deprecated [p]Prototype [d]Definitions

The following are defined C typedefs for deprecated user-defined functions, also included in the file `mpi.h`.

```

/* prototypes for user-defined functions */
typedef int MPI_Copy_function(MPI_Comm oldcomm, int keyval,
                              void *extra_state, void *attribute_val_in,
                              void *attribute_val_out, int *flag);
typedef int MPI_Delete_function(MPI_Comm comm, int keyval,
                                void *attribute_val, void *extra_state);
typedef void MPI_Handler_function(MPI_Comm *, int *, ...);

```

The following are deprecated Fortran user-defined callback subroutine prototypes. The deprecated copy and delete function arguments to `MPI_KEYVAL_CREATE` should be declared like these:

```

SUBROUTINE COPY_FUNCTION(OLDCOMM, KEYVAL, EXTRA_STATE,
                        ATTRIBUTE_VAL_IN, ATTRIBUTE_VAL_OUT, FLAG, IERR)
  INTEGER OLDCOMM, KEYVAL, EXTRA_STATE, ATTRIBUTE_VAL_IN,
          ATTRIBUTE_VAL_OUT, IERR
  LOGICAL FLAG

SUBROUTINE DELETE_FUNCTION(COMM, KEYVAL, ATTRIBUTE_VAL, EXTRA_STATE, IERR)
  INTEGER COMM, KEYVAL, ATTRIBUTE_VAL, EXTRA_STATE, IERR

```

The deprecated handler-function for error handlers should be declared like this:

```

SUBROUTINE HANDLER_FUNCTION(COMM, ERROR_CODE)
  INTEGER COMM, ERROR_CODE

```

A.1.5 Info Keys

```

access_style
appnum
arch
cb_block_size
cb_buffer_size
cb_nodes
chunked_item
chunked_size
chunked

```

1 collective_buffering
2 file_perm
3 filename
4 file
5 host
6 io_node_list
7 ip_address
8 ip_port
9 nb_proc
10 no_locks
11 num_io_nodes
12 path
13 soft
14 striping_factor
15 striping_unit
16 wdir
17
18

19 A.1.6 Info Values

20
21 false
22 random
23 read_mostly
24 read_once
25 reverse_sequential
26 sequential
27 true
28 write_mostly
29 write_once
30
31
32
33
34
35
36
37
38
39
40
41
42
43
44
45
46
47
48

A.2 C Bindings

A.2.1 Point-to-Point Communication C Bindings

```
int MPI_Bsend_init(const void* buf, int count, MPI_Datatype datatype,
                  int dest, int tag, MPI_Comm comm, MPI_Request *request)
int MPI_Bsend(const void* buf, int count, MPI_Datatype datatype, int dest,
              int tag, MPI_Comm comm)
int MPI_Buffer_attach(void* buffer, int size)
int MPI_Buffer_detach(void* buffer_addr, int* size)
int MPI_Cancel(MPI_Request *request)
int MPI_Get_count(const MPI_Status *status, MPI_Datatype datatype,
                 int *count)
int MPI_Ibsend(const void* buf, int count, MPI_Datatype datatype, int dest,
              int tag, MPI_Comm comm, MPI_Request *request)
int MPI_Improbe(int source, int tag, MPI_Comm comm, int *flag,
                MPI_Message *message, MPI_Status *status)
int MPI_Imrecv(void* buf, int count, MPI_Datatype datatype,
               MPI_Message *message, MPI_Request *request)
int MPI_Iprobe(int source, int tag, MPI_Comm comm, int *flag,
               MPI_Status *status)
int MPI_Irecv(void* buf, int count, MPI_Datatype datatype, int source,
              int tag, MPI_Comm comm, MPI_Request *request)
int MPI_Irsend(const void* buf, int count, MPI_Datatype datatype, int dest,
               int tag, MPI_Comm comm, MPI_Request *request)
int MPI_Isend(const void* buf, int count, MPI_Datatype datatype, int dest,
              int tag, MPI_Comm comm, MPI_Request *request)
int MPI_Issend(const void* buf, int count, MPI_Datatype datatype, int dest,
               int tag, MPI_Comm comm, MPI_Request *request)
int MPI_Mprobe(int source, int tag, MPI_Comm comm, MPI_Message *message,
               MPI_Status *status)
int MPI_Mrecv(void* buf, int count, MPI_Datatype datatype,
               MPI_Message *message, MPI_Status *status)
int MPI_Probe(int source, int tag, MPI_Comm comm, MPI_Status *status)
int MPI_Recv_init(void* buf, int count, MPI_Datatype datatype, int source,
                  int tag, MPI_Comm comm, MPI_Request *request)
int MPI_Recv(void* buf, int count, MPI_Datatype datatype, int source,
              int tag, MPI_Comm comm, MPI_Status *status)
```

```

1  int MPI_Request_free(MPI_Request *request)
2
3  int MPI_Request_get_status(MPI_Request request, int *flag,
4      MPI_Status *status)
ticket140. 5  int MPI_Rsend_init(const void* buf, int count, MPI_Datatype datatype,
6      int dest, int tag, MPI_Comm comm, MPI_Request *request)
7
ticket140. 8  int MPI_Rsend(const void* buf, int count, MPI_Datatype datatype, int dest,
9      int tag, MPI_Comm comm)
10
ticket140. 11 int MPI_Send_init(const void* buf, int count, MPI_Datatype datatype,
12     int dest, int tag, MPI_Comm comm, MPI_Request *request)
13
ticket140. 14 int MPI_Send(const void* buf, int count, MPI_Datatype datatype, int dest,
15     int tag, MPI_Comm comm)
16
ticket140. 17 int MPI_Sendrecv(const void *sendbuf, int sendcount, MPI_Datatype sendtype,
18     int dest, int sendtag, void *recvbuf, int recvcount,
19     MPI_Datatype recvtype, int source, int recvtag, MPI_Comm comm,
20     MPI_Status *status)
21
22 int MPI_Sendrecv_replace(void* buf, int count, MPI_Datatype datatype,
23     int dest, int sendtag, int source, int recvtag, MPI_Comm comm,
24     MPI_Status *status)
25
ticket140. 26 int MPI_Ssend_init(const void* buf, int count, MPI_Datatype datatype,
27     int dest, int tag, MPI_Comm comm, MPI_Request *request)
28
ticket140. 29 int MPI_Ssend(const void* buf, int count, MPI_Datatype datatype, int dest,
30     int tag, MPI_Comm comm)
31
ticket125. 32 int MPI_Startall(int count, MPI_Request [*]array_of_requests [])
33
ticket125. 34 int MPI_Start(MPI_Request *request)
35
ticket125. 36 int MPI_Testall(int count, MPI_Request [*]array_of_requests [], int *flag,
37     MPI_Status [*]array_of_statuses [])
38
ticket125. 39 int MPI_Testany(int count, MPI_Request [*]array_of_requests [], int *index,
40     int *flag, MPI_Status *status)
41
ticket125. 42 int MPI_Test_cancelled(const MPI_Status *status, int *flag)
43
ticket140. 44 int MPI_Test(MPI_Request *request, int *flag, MPI_Status *status)
45
46 int MPI_Testsome(int incount, MPI_Request [*]array_of_requests [],
47     int *outcount, int [*]array_of_indices [],
48     MPI_Status [*]array_of_statuses [])
49
50 int MPI_Waitall(int count, MPI_Request [*]array_of_requests [],
51     MPI_Status [*]array_of_statuses [])
52
53 int MPI_Waitany(int count, MPI_Request [*]array_of_requests [], int *index,
54     MPI_Status *status)
55
56
57
58
59
60
61
62
63
64
65
66
67
68
69
70
71
72
73
74
75
76
77
78
79
80
81
82
83
84
85
86
87
88
89
90
91
92
93
94
95
96
97
98
99

```

```

int MPI_Wait(MPI_Request *request, MPI_Status *status) 1
int MPI_Waitsome(int incount, MPI_Request [*]array_of_requests [], 2
    int *outcount, int [*]array_of_indices [], 3 ticket125.
    MPI_Status [*]array_of_statuses []) 4 ticket125.
5 ticket125.
6 ticket125.
7 ticket125.
8
A.2.2 Datatypes C Bindings
int MPI_Get_address(const void *location, MPI_Aint *address) 9 ticket140.
int MPI_Get_elements(const MPI_Status *status, MPI_Datatype datatype, 10 ticket140.
    int *count) 11
12
int MPI_Get_elements_x(MPI_Status *status, MPI_Datatype datatype, 13
    MPI_Count *count) 14
int MPI_Pack_external(const char *datarep, const void *inbuf, int incount, 15 ticket140.
    MPI_Datatype datatype, void *outbuf, MPI_Aint outsize, 16 ticket140.
    MPI_Aint *position) 17
18
int MPI_Pack_external_size(const char *datarep, int incount, 19 ticket140.
    MPI_Datatype datatype, MPI_Aint *size) 20
int MPI_Pack(const void* inbuf, int incount, MPI_Datatype datatype, 21 ticket140.
    void *outbuf, int outsize, int *position, MPI_Comm comm) 22
23
int MPI_Pack_size(int incount, MPI_Datatype datatype, MPI_Comm comm, 24
    int *size) 25
26
int MPI_Type_commit(MPI_Datatype *datatype) 27
int MPI_Type_contiguous(int count, MPI_Datatype oldtype, 28
    MPI_Datatype *newtype) 29
30
int MPI_Type_create_darray(int size, int rank, int ndims, const 31 ticket140.
    int array_of_gsizes[], const int array_of_distrib[], const 32 ticket140.
    int array_of_dargs[], const int array_of_psizes[], int order, 33 ticket140.
    MPI_Datatype oldtype, MPI_Datatype *newtype) 34 ticket140.
35
int MPI_Type_create_hindexed_block(int count, int blocklength, 36
    MPI_Aint array_of_displacements[], MPI_Datatype oldtype, 37
    MPI_Datatype *newtype) 38
int MPI_Type_create_hindexed(int count, const int array_of_blocklengths[], 39 ticket140.
    const MPI_Aint array_of_displacements[], MPI_Datatype oldtype, 40 ticket140.
    MPI_Datatype *newtype) 41
42
int MPI_Type_create_hvector(int count, int blocklength, MPI_Aint stride, 43
    MPI_Datatype oldtype, MPI_Datatype *newtype) 44
int MPI_Type_create_indexed_block(int count, int blocklength, const 45 ticket140.
    int array_of_displacements[], MPI_Datatype oldtype, 46
    MPI_Datatype *newtype) 47
48

```

```

1 int MPI_Type_create_resized(MPI_Datatype oldtype, MPI_Aint lb, MPI_Aint
2     extent, MPI_Datatype *newtype)
3
ticket140. 4 int MPI_Type_create_struct(int count, const int array_of_blocklengths[],
ticket140. 5     const MPI_Aint array_of_displacements[], const
ticket140. 6     MPI_Datatype array_of_types[], MPI_Datatype *newtype)
7
ticket140. 8 int MPI_Type_create_subarray(int ndims, const int array_of_sizes[], const
ticket140. 9     int array_of_subsizes[], const int array_of_starts[], int
10     order, MPI_Datatype oldtype, MPI_Datatype *newtype)
ticket252-W. 11 int MPI_Type_dup(MPI_Datatype oldtype, MPI_Datatype *newtype)
12
13 int MPI_Type_free(MPI_Datatype *datatype)
14
15 int MPI_Type_get_contents(MPI_Datatype datatype, int max_integers,
16     int max_addresses, int max_datatypes, int array_of_integers[],
17     MPI_Aint array_of_addresses[],
18     MPI_Datatype array_of_datatypes[])
19
20 int MPI_Type_get_envelope(MPI_Datatype datatype, int *num_integers,
21     int *num_addresses, int *num_datatypes, int *combiner)
22
23 int MPI_Type_get_extent(MPI_Datatype datatype, MPI_Aint *lb,
24     MPI_Aint *extent)
25
ticket140. 26 int MPI_Type_indexed(int count, const int *array_of_blocklengths, const
ticket140. 27     int *array_of_displacements, MPI_Datatype oldtype,
28     MPI_Datatype *newtype)
29
30 int MPI_Type_size(MPI_Datatype datatype, int *size)
31
32 int MPI_Type_vector(int count, int blocklength, int stride,
33     MPI_Datatype oldtype, MPI_Datatype *newtype)
ticket140. 34 int MPI_Unpack_external(const char *datarep, const void *inbuf,
ticket140. 35     MPI_Aint insize, MPI_Aint *position, void *outbuf,
36     int outcount, MPI_Datatype datatype)
37
ticket140. 38 int MPI_Unpack(const void* inbuf, int insize, int *position, void *outbuf,
39     int outcount, MPI_Datatype datatype, MPI_Comm comm)
40

```

A.2.3 Collective Communication C Bindings

```

ticket140. 42 int MPI_Allgather(const void* sendbuf, int sendcount,
43     MPI_Datatype sendtype, void* recvbuf, int recvcount,
44     MPI_Datatype recvtype, MPI_Comm comm)
45
ticket140. 46 int MPI_Allgatherv(const void* sendbuf, int sendcount,
ticket140. 47     MPI_Datatype sendtype, void* recvbuf, const int recvcounts[],
ticket140. 48     const int displs[], MPI_Datatype recvtype, MPI_Comm comm)

```

```

int MPI_Allreduce(const void* sendbuf, void* recvbuf, int count,
                 MPI_Datatype datatype, MPI_Op op, MPI_Comm comm)
int MPI_Alltoall(const void* sendbuf, int sendcount, MPI_Datatype sendtype,
                void* recvbuf, int recvcount, MPI_Datatype recvtype,
                MPI_Comm comm)
int MPI_Alltoallv(const void* sendbuf, const int sendcounts[], const
                 int sdispls[], MPI_Datatype sendtype, void* recvbuf, const
                 int recvcnts[], const int rdispls[], MPI_Datatype recvtype,
                 MPI_Comm comm)
int MPI_Alltoallw(const void* sendbuf, const int sendcounts[], const
                 int sdispls[], const MPI_Datatype sendtypes[], void* recvbuf,
                 const int recvcnts[], const int rdispls[], const
                 MPI_Datatype recvtypes[], MPI_Comm comm)
int MPI_Barrier(MPI_Comm comm)
int MPI_Bcast(void* buffer, int count, MPI_Datatype datatype, int root,
              MPI_Comm comm)
int MPI_Exscan(const void* sendbuf, void* recvbuf, int count,
               MPI_Datatype datatype, MPI_Op op, MPI_Comm comm)
int MPI_Gather(const void* sendbuf, int sendcount, MPI_Datatype sendtype,
               void* recvbuf, int recvcount, MPI_Datatype recvtype, int root,
               MPI_Comm comm)
int MPI_Gatherv(const void* sendbuf, int sendcount, MPI_Datatype sendtype,
                void* recvbuf, const int recvcnts[], const int displs[],
                MPI_Datatype recvtype, int root, MPI_Comm comm)
int MPI_Iallgather(const void* sendbuf, int sendcount,
                  MPI_Datatype sendtype, void* recvbuf, int recvcount,
                  MPI_Datatype recvtype, MPI_Comm comm, MPI_Request *request)
int MPI_Iallgatherv(const void* sendbuf, int sendcount,
                   MPI_Datatype sendtype, void* recvbuf, const int recvcnts[],
                   const int displs[], MPI_Datatype recvtype, MPI_Comm comm,
                   MPI_Request* request)
int MPI_Iallreduce(const void* sendbuf, void* recvbuf, int count,
                  MPI_Datatype datatype, MPI_Op op, MPI_Comm comm,
                  MPI_Request *request)
int MPI_Ialltoall(const void* sendbuf, int sendcount,
                  MPI_Datatype sendtype, void* recvbuf, int recvcount,
                  MPI_Datatype recvtype, MPI_Comm comm, MPI_Request *request)
int MPI_Ialltoallv(const void* sendbuf, const int sendcounts[], const
                  int sdispls[], MPI_Datatype sendtype, void* recvbuf, const
                  int recvcnts[], const int rdispls[], MPI_Datatype recvtype,
                  MPI_Comm comm, MPI_Request *request)

```

```

ticket140. 1 int MPI_Ialltoallw(const void* sendbuf, const int sendcounts[], const
ticket140. 2     int sdispls[], const MPI_Datatype sendtypes[], void* recvbuf,
ticket140. 3     const int recvcounts[], const int rdispls[], const
ticket140. 4     MPI_Datatype recvtypes[], MPI_Comm comm, MPI_Request *request)
ticket140. 5
ticket140. 6 int MPI_IbARRIER(MPI_Comm comm, MPI_Request *request)
ticket140. 7
ticket140. 8 int MPI_Ibcast(const void* buffer, int count, MPI_Datatype datatype,
ticket140. 9     int root, MPI_Comm comm, MPI_Request *request)
ticket140. 10
ticket140. 11 int MPI_Iexscan(const void* sendbuf, void* recvbuf, int count,
ticket140. 12     MPI_Datatype datatype, MPI_Op op, MPI_Comm comm,
ticket140. 13     MPI_Request *request)
ticket140. 14
ticket140. 15 int MPI_Igather(const void* sendbuf, int sendcount, MPI_Datatype sendtype,
ticket140. 16     void* recvbuf, int recvcount, MPI_Datatype recvtype, int root,
ticket140. 17     MPI_Comm comm, MPI_Request *request)
ticket140. 18
ticket140. 19 int MPI_Igatherv(const void* sendbuf, int sendcount, MPI_Datatype sendtype,
ticket140. 20     void* recvbuf, const int recvcounts[], const int displs[],
ticket140. 21     MPI_Datatype recvtype, int root, MPI_Comm comm,
ticket140. 22     MPI_Request *request)
ticket140. 23
ticket140. 24 int MPI_Ireduce(const void* sendbuf, void* recvbuf, int count,
ticket140. 25     MPI_Datatype datatype, MPI_Op op, int root, MPI_Comm comm,
ticket140. 26     MPI_Request *request)
ticket140. 27
ticket140. 28 int MPI_Ireduce_scatter_block(const void* sendbuf, void* recvbuf,
ticket140. 29     int recvcount, MPI_Datatype datatype, MPI_Op op,
ticket140. 30     MPI_Comm comm, MPI_Request *request)
ticket140. 31
ticket140. 32 int MPI_Iscan(const void* sendbuf, void* recvbuf, int count,
ticket140. 33     MPI_Datatype datatype, MPI_Op op, MPI_Comm comm,
ticket140. 34     MPI_Request *request)
ticket140. 35
ticket140. 36 int MPI_Iscatter(const void* sendbuf, int sendcount, MPI_Datatype sendtype,
ticket140. 37     void* recvbuf, int recvcount, MPI_Datatype recvtype, int root,
ticket140. 38     MPI_Comm comm, MPI_Request *request)
ticket140. 39
ticket140. 40 int MPI_Iscatterv(const void* sendbuf, const int sendcounts[], const
ticket140. 41     int displs[], MPI_Datatype sendtype, void* recvbuf,
ticket140. 42     int recvcount, MPI_Datatype recvtype, int root, MPI_Comm comm,
ticket140. 43     MPI_Request *request)
ticket140. 44
ticket252-W. 45 int MPI_Op_create(MPI_User_function* [function]user_fn, int commute,
ticket140. 46     MPI_Op* op)
ticket140. 47
ticket140. 48 int MPI_Op_free(MPI_Op *op)

```



```

int MPI_Reduce_local(const void* inbuf, void* inoutbuf, int count,
                    MPI_Datatype datatype, MPI_Op op)
int MPI_Reduce(const void* sendbuf, void* recvbuf, int count,
              MPI_Datatype datatype, MPI_Op op, int root, MPI_Comm comm)
int MPI_Reduce_scatter_block(const void* sendbuf, void* recvbuf,
                             int recvcnt, MPI_Datatype datatype, MPI_Op op,
                             MPI_Comm comm)
int MPI_Reduce_scatter(const void* sendbuf, void* recvbuf, const
                       int recvcnts[], MPI_Datatype datatype, MPI_Op op,
                       MPI_Comm comm)
int MPI_Scan(const void* sendbuf, void* recvbuf, int count,
            MPI_Datatype datatype, MPI_Op op, MPI_Comm comm)
int MPI_Scatter(const void* sendbuf, int sendcount, MPI_Datatype sendtype,
               void* recvbuf, int recvcnt, MPI_Datatype recvttype, int root,
               MPI_Comm comm)
int MPI_Scatterv(const void* sendbuf, const int sendcounts[], const
                int displs[], MPI_Datatype sendtype, void* recvbuf,
                int recvcnt, MPI_Datatype recvttype, int root, MPI_Comm comm)

```

1 ticket140.
2
3
4 ticket140.
5
6 ticket140.
7
8
9
10 ticket140.
11 ticket140.
12
13 ticket140.
14
15
16 ticket140.
17
18
19 ticket140.
20 ticket140.
21 ticket140.
22
23
24
25
26
27
28
29
30
31
32
33
34
35
36
37
38
39
40
41
42
43
44
45
46
47
48

A.2.4 Groups, Contexts, Communicators, and Caching C Bindings

```

int MPI_Comm_compare(MPI_Comm comm1, MPI_Comm comm2, int *result)
int MPI_Comm_create_keyval(MPI_Comm_copy_attr_function *comm_copy_attr_fn,
                           MPI_Comm_delete_attr_function *comm_delete_attr_fn,
                           int *comm_keyval, void *extra_state)
int MPI_Comm_create(MPI_Comm comm, MPI_Group group, MPI_Comm *newcomm)
int MPI_Comm_delete_attr(MPI_Comm comm, int comm_keyval)
int MPI_COMM_DUP_FN(MPI_Comm oldcomm, int comm_keyval, void *extra_state,
                    void *attribute_val_in, void *attribute_val_out, int *flag)
int MPI_Comm_dup(MPI_Comm comm, MPI_Comm *newcomm)
int MPI_Comm_free_keyval(int *comm_keyval)
int MPI_Comm_free(MPI_Comm *comm)
int MPI_Comm_get_attr(MPI_Comm comm, int comm_keyval, void *attribute_val,
                      int *flag)
int MPI_Comm_get_name(MPI_Comm comm, char *comm_name, int *resultlen)
int MPI_Comm_group(MPI_Comm comm, MPI_Group *group)
int MPI_COMM_NULL_COPY_FN(MPI_Comm oldcomm, int comm_keyval,
                           void *extra_state, void *attribute_val_in,

```

25
26
27
28
29
30
31
32
33
34
35
36
37
38
39
40
41
42
43
44
45
46
47
48

```

1         void *attribute_val_out, int *flag)
2
3     int MPI_COMM_NULL_DELETE_FN(MPI_Comm comm, int comm_keyval, void
4         *attribute_val, void *extra_state)
5
6     int MPI_Comm_rank(MPI_Comm comm, int *rank)
7
8     int MPI_Comm_remote_group(MPI_Comm comm, MPI_Group *group)
9
10    int MPI_Comm_remote_size(MPI_Comm comm, int *size)
11
12    int MPI_Comm_set_attr(MPI_Comm comm, int comm_keyval, void *attribute_val)
13
14    int MPI_Comm_set_name(MPI_Comm comm, const char *comm_name)
15
16    int MPI_Comm_size(MPI_Comm comm, int *size)
17
18    int MPI_Comm_split(MPI_Comm comm, int color, int key, MPI_Comm *newcomm)
19
20    int MPI_Comm_split_type(MPI_Comm comm, int split_type, int key, MPI_Info
21        info, MPI_Comm *newcomm)
22
23    int MPI_Comm_test_inter(MPI_Comm comm, int *flag)
24
25    int MPI_Group_compare(MPI_Group group1, MPI_Group group2, int *result)
26
27    int MPI_Group_difference(MPI_Group group1, MPI_Group group2,
28        MPI_Group *newgroup)
29
30    int MPI_Group_excl(MPI_Group group, int n, const int *ranks,
31        MPI_Group *newgroup)
32
33    int MPI_Group_free(MPI_Group *group)
34
35    int MPI_Group_incl(MPI_Group group, int n, const int *ranks,
36        MPI_Group *newgroup)
37
38    int MPI_Group_intersection(MPI_Group group1, MPI_Group group2,
39        MPI_Group *newgroup)
40
41    int MPI_Group_range_excl(MPI_Group group, int n, int ranges[][3],
42        MPI_Group *newgroup)
43
44    int MPI_Group_range_incl(MPI_Group group, int n, int ranges[][3],
45        MPI_Group *newgroup)
46
47    int MPI_Group_rank(MPI_Group group, int *rank)
48
49    int MPI_Group_size(MPI_Group group, int *size)
50
51    int MPI_Group_translate_ranks (MPI_Group group1, int n, const int *ranks1,
52        MPI_Group group2, int *ranks2)
53
54    int MPI_Group_union(MPI_Group group1, MPI_Group group2,
55        MPI_Group *newgroup)
56
57    int MPI_Intercomm_create(MPI_Comm local_comm, int local_leader,
58        MPI_Comm peer_comm, int remote_leader, int tag,
59

```

```

        MPI_Comm *newintercomm)
1
2
int MPI_Intercomm_merge(MPI_Comm intercomm, int high,
3
4
5
6
7
8
9
10
11
12
13
14
15
16
17
18
19
20
21
22
23
24
25
26
27
28
29
30
31
32
33
34
35
36
37
38
39
40
41
42
43
44
45
46
47
48
        MPI_Comm *newintracomm)
int MPI_Type_create_keyval(MPI_Type_copy_attr_function *type_copy_attr_fn,
        MPI_Type_delete_attr_function *type_delete_attr_fn,
        int *type_keyval, void *extra_state)
int MPI_Type_delete_attr(MPI_Datatype datatype, int type_keyval)
int MPI_Type_DELETE_FN(MPI_Datatype oldtype, int type_keyval,
        void *extra_state, void *attribute_val_in,
        void *attribute_val_out, int *flag)
int MPI_Type_free_keyval(int *type_keyval)
int MPI_Type_get_attr(MPI_Datatype datatype, int type_keyval, void
        *attribute_val, int *flag)
int MPI_Type_get_name(MPI_Datatype datatype, char *type_name, int
        *resultlen)
int MPI_Type_NULL_COPY_FN(MPI_Datatype oldtype, int type_keyval,
        void *extra_state, void *attribute_val_in,
        void *attribute_val_out, int *flag)
int MPI_Type_NULL_DELETE_FN(MPI_Datatype datatype, int type_keyval, void
        *attribute_val, void *extra_state)
int MPI_Type_set_attr(MPI_Datatype datatype, int type_keyval,
        void *attribute_val)
int MPI_Type_set_name(MPI_Datatype datatype, const char *type_name)
int MPI_Win_create_keyval(MPI_Win_copy_attr_function *win_copy_attr_fn,
        MPI_Win_delete_attr_function *win_delete_attr_fn,
        int *win_keyval, void *extra_state)
int MPI_Win_delete_attr(MPI_Win win, int win_keyval)
int MPI_Win_DELETE_FN(MPI_Win oldwin, int win_keyval, void *extra_state,
        void *attribute_val_in, void *attribute_val_out, int *flag)
int MPI_Win_free_keyval(int *win_keyval)
int MPI_Win_get_attr(MPI_Win win, int win_keyval, void *attribute_val,
        int *flag)
int MPI_Win_get_name(MPI_Win win, char *win_name, int *resultlen)
int MPI_Win_NULL_COPY_FN(MPI_Win oldwin, int win_keyval, void *extra_state,
        void *attribute_val_in, void *attribute_val_out, int *flag)
int MPI_Win_NULL_DELETE_FN(MPI_Win win, int win_keyval, void
        *attribute_val, void *extra_state)

```

```
1 int MPI_Win_set_attr(MPI_Win win, int win_keyval, void *attribute_val)
```

```
2 int MPI_Win_set_name(MPI_Win win, const char *win_name)
```

A.2.5 Process Topologies C Bindings

```
7 int MPI_Cart_coords(MPI_Comm comm, int rank, int maxdims,
8 int [*coords] coords[])
```

```
9 int MPI_Cart_create(MPI_Comm comm_old, int ndims, const int [*dims] dims[],
10 const int [*periods] periods[], int reorder,
11 MPI_Comm *comm_cart)
```

```
12 int MPI_Cartdim_get(MPI_Comm comm, int *ndims)
```

```
14 int MPI_Cart_get(MPI_Comm comm, int maxdims, int [*dims] dims[],
15 int [*periods] periods[], int [*coords] coords[])
```

```
16 int MPI_Cart_map(MPI_Comm comm, int ndims, const int [*dims] dims[], const
17 int [*periods] periods[], int *newrank)
```

```
18 int MPI_Cart_rank(MPI_Comm comm, const int [*coords] coords[], int *rank)
```

```
19 int MPI_Cart_shift(MPI_Comm comm, int direction, int disp,
20 int *rank_source, int *rank_dest)
```

```
21 int MPI_Cart_sub(MPI_Comm comm, const int [*remain_dims] remain_dims[],
22 MPI_Comm *newcomm)
```

```
23 int MPI_Dims_create(int nnodes, int ndims, int [*dims] dims[])
```

```
24 int MPI_Dist_graph_create_adjacent(MPI_Comm comm_old, int indegree, const
25 int sources[], const int sourceweights[], int outdegree, const
26 int destinations[], const int destweights[], MPI_Info info,
27 int reorder, MPI_Comm *comm_dist_graph)
```

```
28 int MPI_Dist_graph_create(MPI_Comm comm_old, int n, const int sources[],
29 const int degrees[], const int destinations[], const
30 int weights[], MPI_Info info, int reorder,
31 MPI_Comm *comm_dist_graph)
```

```
32 int MPI_Dist_graph_neighbors_count(MPI_Comm comm, int *indegree,
33 int *outdegree, int *weighted)
```

```
34 int MPI_Dist_graph_neighbors(MPI_Comm comm, int maxindegree, int sources[],
35 int sourceweights[], int maxoutdegree, int destinations[],
36 int destweights[])
```

```
37 int MPI_Graph_create(MPI_Comm comm_old, int nnodes, const
38 int [*index] index[], const int [*edges] edges[], int reorder,
39 MPI_Comm *comm_graph)
```

```
40 int MPI_Graphdims_get(MPI_Comm comm, int *nnodes, int *nedges)
```

```

int MPI_Graph_get(MPI_Comm comm, int maxindex, int maxedges,
                 int [*index]index[], int [*edges]edges[])
int MPI_Graph_map(MPI_Comm comm, int nnodes, const int [*index]index[],
                 const int [*edges]edges[], int *newrank)
int MPI_Graph_neighbors_count(MPI_Comm comm, int rank, int *nneighbors)
int MPI_Graph_neighbors(MPI_Comm comm, int rank, int maxneighbors,
                        int [*neighbors]neighbors[])
int MPI_Ineighbor_allgather(const void* sendbuf, int sendcount,
                           MPI_Datatype sendtype, void* recvbuf, int recvcount,
                           MPI_Datatype recvtype, MPI_Comm comm, MPI_Request *request)
int MPI_Ineighbor_allgatherv(const void* sendbuf, int sendcount,
                             MPI_Datatype sendtype, void* recvbuf, const int recvcnts[],
                             const int displs[], MPI_Datatype recvtype, MPI_Comm comm,
                             MPI_Request *request)
int MPI_Ineighbor_alltoall(const void* sendbuf, int sendcount, MPI_Datatype
                           sendtype, void* recvbuf, int recvcount, MPI_Datatype recvtype,
                           MPI_Comm comm, MPI_Request *request)
int MPI_Ineighbor_alltoallv(const void* sendbuf, const int sendcounts[],
                             const int sdispls[], MPI_Datatype sendtype, void* recvbuf,
                             const int recvcnts[], const int rdispls[], MPI_Datatype
                             recvtype, MPI_Comm comm, MPI_Request *request)
int MPI_Ineighbor_alltoallw(const void* sendbuf, const int sendcounts[],
                             const [int]MPI_Aint sdispls[], const MPI_Datatype sendtypes[],
                             void* recvbuf, const int recvcnts[], const [int]MPI_Aint
                             rdispls[], const MPI_Datatype recvtypes[], MPI_Comm comm,
                             MPI_Request *request)
int MPI_Neighbor_allgather(const void* sendbuf, int sendcount, MPI_Datatype
                           sendtype, void* recvbuf, int recvcount, MPI_Datatype recvtype,
                           MPI_Comm comm)
int MPI_Neighbor_allgatherv(const void* sendbuf, int sendcount,
                             MPI_Datatype sendtype, void* recvbuf, const int recvcnts[],
                             const int displs[], MPI_Datatype recvtype, MPI_Comm comm)
int MPI_Neighbor_alltoall(const void* sendbuf, int sendcount, MPI_Datatype
                           sendtype, void* recvbuf, int recvcount, MPI_Datatype recvtype,
                           MPI_Comm comm)
int MPI_Neighbor_alltoallv(const void* sendbuf, const int sendcounts[],
                             const int sdispls[], MPI_Datatype sendtype, void* recvbuf,
                             const int recvcnts[], const int rdispls[], MPI_Datatype
                             recvtype, MPI_Comm comm)
int MPI_Neighbor_alltoallw(const void* sendbuf, const int sendcounts[],
                             const [int]MPI_Aint sdispls[], const MPI_Datatype sendtypes[],

```

```

ticket140. 1         void* recvbuf, const int recvcounts[], const [int]MPI_Aint
ticket140. 2         rdispls[], const MPI_Datatype recvtypes[], MPI_Comm comm)
ticket299. 3
ticket140. 4 int MPI_Topo_test(MPI_Comm comm, int *status)

```

5

6

A.2.6 MPI Environmental Management C Bindings

7

8

```
int MPI_Abort(MPI_Comm comm, int errorcode)
```

9

```
int MPI_Add_error_class(int *errorclass)
```

10

```
int MPI_Add_error_code(int errorclass, int *errorcode)
```

11

ticket140.

```
int MPI_Add_error_string(int errorcode, const char *string)
```

12

13

```
int MPI_Alloc_mem(MPI_Aint size, MPI_Info info, void *baseptr)
```

14

```
int MPI_Comm_call_errhandler(MPI_Comm comm, int errorcode)
```

15

16

```
int MPI_Comm_create_errhandler(MPI_Comm_errhandler_function
```

ticket252-W.

17

```
    *[function]comm_errhandler_fn, MPI_Errhandler *errhandler)
```

18

```
int MPI_Comm_get_errhandler(MPI_Comm comm, MPI_Errhandler *errhandler)
```

19

20

```
int MPI_Comm_set_errhandler(MPI_Comm comm, MPI_Errhandler errhandler)
```

21

```
int MPI_Errhandler_free(MPI_Errhandler *errhandler)
```

22

```
int MPI_Error_class(int errorcode, int *errorclass)
```

23

```
int MPI_Error_string(int errorcode, char *string, int *resultlen)
```

24

```
int MPI_File_call_errhandler(MPI_File fh, int errorcode)
```

25

26

```
int MPI_File_create_errhandler(MPI_File_errhandler_function
```

ticket252-W.

27

```
    *[function]file_errhandler_fn, MPI_Errhandler *errhandler)
```

28

```
int MPI_File_get_errhandler(MPI_File file, MPI_Errhandler *errhandler)
```

29

30

```
int MPI_File_set_errhandler(MPI_File file, MPI_Errhandler errhandler)
```

31

```
int MPI_Finalized(int *flag)
```

32

```
int MPI_Finalize(void)
```

33

```
int MPI_Free_mem(void *base)
```

34

```
int MPI_Get_library_version(char *version, int *resultlen)
```

35

```
int MPI_Get_processor_name(char *name, int *resultlen)
```

36

```
int MPI_Get_version(int *version, int *subversion)
```

37

```
int MPI_Initialized(int *flag)
```

38

```
int MPI_Init(int *argc, char ***argv)
```

39

```
int MPI_Win_call_errhandler(MPI_Win win, int errorcode)
```

40

41

```

int MPI_Win_create_errhandler(MPI_Win_errhandler_function      1
                             *[function]win_errhandler_fn, MPI_Errhandler *errhandler) 2 ticket252-W.
int MPI_Win_get_errhandler(MPI_Win win, MPI_Errhandler *errhandler) 3
int MPI_Win_set_errhandler(MPI_Win win, MPI_Errhandler errhandler) 4
double MPI_Wtick(void) 5
double MPI_Wtime(void) 6

```

A.2.7 The Info Object C Bindings

```

int MPI_Info_create(MPI_Info *info) 10
int MPI_Info_delete(MPI_Info info, const char *key) 11
int MPI_Info_dup(MPI_Info info, MPI_Info *newinfo) 12
int MPI_Info_free(MPI_Info *info) 13
int MPI_Info_get(MPI_Info info, const char *key, int valuelen, char *value, 14 ticket140.
                  int *flag) 15
int MPI_Info_get_nkeys(MPI_Info info, int *nkeys) 16
int MPI_Info_get_nthkey(MPI_Info info, int n, char *key) 17
int MPI_Info_get_valuelen(MPI_Info info, const char *key, int *valuelen, 18
                           int *flag) 19 ticket140.
int MPI_Info_set(MPI_Info info, const char *key, const char *value) 20

```

A.2.8 Process Creation and Management C Bindings

```

int MPI_Close_port(const char *port_name) 21
int MPI_Comm_accept(const char *port_name, MPI_Info info, int root, 22
                   MPI_Comm comm, MPI_Comm *newcomm) 23 ticket140.
int MPI_Comm_connect(const char *port_name, MPI_Info info, int root, 24 ticket140.
                    MPI_Comm comm, MPI_Comm *newcomm) 25 ticket140.
int MPI_Comm_disconnect(MPI_Comm *comm) 26
int MPI_Comm_get_parent(MPI_Comm *parent) 27
int MPI_Comm_join(int fd, MPI_Comm *intercomm) 28
int MPI_Comm_spawn(const char *command, char *argv[], int maxprocs, 29
                  MPI_Info info, int root, MPI_Comm comm, MPI_Comm *intercomm, 30
                  int array_of_errcodes[]) 31 ticket140.
int MPI_Comm_spawn_multiple(int count, char *array_of_commands[], 32
                             char **array_of_argv[], const int array_of_maxprocs[], const 33
                             34 ticket140.
                             35 ticket140.
                             36
                             37
                             38
                             39
                             40
                             41
                             42 ticket140.
                             43
                             44
                             45
                             46
                             47 ticket140.
                             48 ticket140.

```

```

1           MPI_Info array_of_info[], int root, MPI_Comm comm,
2           MPI_Comm *intercomm, int array_of_errcodes[])
3
ticket140. 4 int MPI_Lookup_name(const char *service_name, MPI_Info info,
5           char *port_name)
6
6 int MPI_Open_port(MPI_Info info, char *port_name)
7
ticket140. 8 int MPI_Publish_name(const char *service_name, MPI_Info info, const
ticket140. 9 char *port_name)
10
ticket140. 11 int MPI_Unpublish_name(const char *service_name, MPI_Info info, const
ticket140. 12 char *port_name)
13
14 A.2.9 One-Sided Communications C Bindings
15
ticket140. 16 int MPI_Accumulate(const void *origin_addr, int origin_count,
17           MPI_Datatype origin_datatype, int target_rank,
18           MPI_Aint target_disp, int target_count,
19           MPI_Datatype target_datatype, MPI_Op op, MPI_Win win)
20
ticket140a. 21 int MPI_Compare_and_swap(const void *origin_addr, const void *compare_addr,
ticket140a. 22 void *result_addr, MPI_Datatype datatype, int target_rank,
23           MPI_Aint target_disp, MPI_Win win)
24
ticket140a. 25 int MPI_Fetch_and_op(const void *origin_addr, void *result_addr,
26           MPI_Datatype datatype, int target_rank, MPI_Aint target_disp,
27           MPI_Op op, MPI_Win win)
28
ticket140a. 29 int MPI_Get_accumulate(const void *origin_addr, int origin_count,
30           MPI_Datatype origin_datatype, void *result_addr,
31           int result_count, MPI_Datatype result_datatype,
32           int target_rank, MPI_Aint target_disp, int target_count,
33           MPI_Datatype target_datatype, MPI_Op op, MPI_Win win)
34
35 int MPI_Get(void *origin_addr, int origin_count,
36           MPI_Datatype origin_datatype, int target_rank,
37           MPI_Aint target_disp, int target_count,
38           MPI_Datatype target_datatype, MPI_Win win)
39
ticket140. 40 int MPI_Put(const void *origin_addr, int origin_count, MPI_Datatype
41           origin_datatype, int target_rank, MPI_Aint target_disp, int
42           target_count, MPI_Datatype target_datatype, MPI_Win win)
43
ticket140a. 44 int MPI_Raccumulate(const void *origin_addr, int origin_count,
45           MPI_Datatype origin_datatype, int target_rank,
46           MPI_Aint target_disp, int target_count,
47           MPI_Datatype target_datatype, MPI_Op op, MPI_Win win,
48           MPI_Request *request)
49
ticket140a. 50 int MPI_Rget_accumulate(const void *origin_addr, int origin_count,
51           MPI_Datatype origin_datatype, void *result_addr,
52           int result_count, MPI_Datatype result_datatype,
53           int target_rank, MPI_Aint target_disp, int target_count,
54           MPI_Datatype target_datatype, MPI_Op op, MPI_Win win,
55           MPI_Request *request)

```



```

        int target_rank, MPI_Aint target_disp, int target_count,
        MPI_Datatype target_datatype, MPI_Op op, MPI_Win win,
        MPI_Request *request)
1
2
3
4
int MPI_Rget(void *origin_addr, int origin_count,
5
        MPI_Datatype origin_datatype, int target_rank,
6
        MPI_Aint target_disp, int target_count,
7
        MPI_Datatype target_datatype, MPI_Win win,
8
        MPI_Request *request)
9
int MPI_Rput(const void *origin_addr, int origin_count,
10 ticket140a.
        MPI_Datatype origin_datatype, int target_rank,
11
        MPI_Aint target_disp, int target_count,
12
        MPI_Datatype target_datatype, MPI_Win win,
13
        MPI_Request *request)
14
15
int MPI_Win_allocate(MPI_Aint size, int disp_unit, MPI_Info info,
16
        MPI_Comm comm, void *baseptr, MPI_Win *win)
17
18
int MPI_Win_allocate_shared(MPI_Aint size, MPI_Info info, MPI_Comm comm,
19
        void *baseptr, MPI_Win *win)
20
21
int MPI_Win_attach(MPI_Win win, void *base, MPI_Aint size)
22
23
int MPI_Win_complete(MPI_Win win)
24
25
int MPI_Win_create_dynamic(MPI_Info info, MPI_Comm comm, MPI_Win *win)
26
27
int MPI_Win_create(void *base, MPI_Aint size, int disp_unit, MPI_Info info,
28 ticket140a.
        MPI_Comm comm, MPI_Win *win)
29
30
int MPI_Win_detach(MPI_Win win, const void *base)
31
32
int MPI_Win_fence(int assert, MPI_Win win)
33
34
int MPI_Win_flush_all(MPI_Win win)
35
36
int MPI_Win_flush(int rank, MPI_Win win)
37
38
int MPI_Win_flush_local_all(MPI_Win win)
39
40
int MPI_Win_flush_local(int rank, MPI_Win win)
41
42
int MPI_Win_free(MPI_Win *win)
43
44
int MPI_Win_get_group(MPI_Win win, MPI_Group *group)
45
46
int MPI_Win_lock_all(int assert, MPI_Win win)
47
48
int MPI_Win_lock(int lock_type, int rank, int assert, MPI_Win win)
49
50
int MPI_Win_post(MPI_Group group, int assert, MPI_Win win)
51
52
int MPI_Win_shared_query(MPI_Win win, int rank, MPI_Aint *size,
53
        void *baseptr)
54
55
int MPI_Win_start(MPI_Group group, int assert, MPI_Win win)
56
57
58
59
60
61
62
63
64
65
66
67
68
69
70
71
72
73
74
75
76
77
78
79
80
81
82
83
84
85
86
87
88
89
90
91
92
93
94
95
96
97
98
99

```

```

1 int MPI_Win_sync(MPI_Win win)
2
3 int MPI_Win_test(MPI_Win win, int *flag)
4
5 int MPI_Win_unlock_all(MPI_Win win)
6
7 int MPI_Win_unlock(int rank, MPI_Win win)
8
9 int MPI_Win_wait(MPI_Win win)

```

10 A.2.10 External Interfaces C Bindings

```

11 int MPI_Grequest_complete(MPI_Request request)
12
13 int MPI_Grequest_start(MPI_Grequest_query_function *query_fn,
14                       MPI_Grequest_free_function *free_fn,
15                       MPI_Grequest_cancel_function *cancel_fn, void *extra_state,
16                       MPI_Request *request)
17
18 int MPI_Init_thread(int *argc, char ((*argv)[]), int required,
19                  int *provided)
20
21 int MPI_Is_thread_main(int *flag)
22
23 int MPI_Query_thread(int *provided)
24
25 int MPI_Status_set_cancelled(MPI_Status *status, int flag)
26
27 int MPI_Status_set_elements(MPI_Status *status, MPI_Datatype datatype,
28                            MPI_Count count)
29
30 int MPI_Status_set_elements_x(MPI_Status *status, MPI_Datatype datatype,
31                              MPI_Count count)

```

31 A.2.11 I/O C Bindings

```

32 int MPI_File_close(MPI_File *fh)
33
34 int MPI_File_delete(const char *filename, MPI_Info info)
35
36 int MPI_File_get_amode(MPI_File fh, int *amode)
37
38 int MPI_File_get_atomicity(MPI_File fh, int *flag)
39
40 int MPI_File_get_byte_offset(MPI_File fh, MPI_Offset offset,
41                             MPI_Offset *disp)
42
43 int MPI_File_get_group(MPI_File fh, MPI_Group *group)
44
45 int MPI_File_get_info(MPI_File fh, MPI_Info *info_used)
46
47 int MPI_File_get_position(MPI_File fh, MPI_Offset *offset)
48
49 int MPI_File_get_position_shared(MPI_File fh, MPI_Offset *offset)
50
51 int MPI_File_get_size(MPI_File fh, MPI_Offset *size)

```

```

int MPI_File_get_type_extent(MPI_File fh, MPI_Datatype datatype,      1
                             MPI_Aint *extent)                        2
int MPI_File_get_view(MPI_File fh, MPI_Offset *disp, MPI_Datatype *etype, 3
                      MPI_Datatype *filetype, char *datarep)        4
int MPI_File_iread_at(MPI_File fh, MPI_Offset offset, void *buf, int count, 6
                     MPI_Datatype datatype, MPI_Request *request)   7
int MPI_File_iread(MPI_File fh, void *buf, int count,                8
                  MPI_Datatype datatype, MPI_Request *request)     9
int MPI_File_iread_shared(MPI_File fh, void *buf, int count,       11
                          MPI_Datatype datatype, MPI_Request *request) 12
int MPI_File_iwrite_at(MPI_File fh, MPI_Offset offset, const void *buf, 14 ticket140.
                      int count, MPI_Datatype datatype, MPI_Request *request) 15
int MPI_File_iwrite(MPI_File fh, const void *buf, int count,       16 ticket140.
                   MPI_Datatype datatype, MPI_Request *request)   17
int MPI_File_iwrite_shared(MPI_File fh, const void *buf, int count, 19 ticket140.
                          MPI_Datatype datatype, MPI_Request *request) 20
int MPI_File_open(MPI_Comm comm, const char *filename, int amode, 21 ticket140.
                 MPI_Info info, MPI_File *fh)                     22
int MPI_File_preallocate(MPI_File fh, MPI_Offset size)            24
int MPI_File_read_all_begin(MPI_File fh, void *buf, int count,    25
                            MPI_Datatype datatype)                26
int MPI_File_read_all_end(MPI_File fh, void *buf, MPI_Status *status) 28
int MPI_File_read_all(MPI_File fh, void *buf, int count,          29
                     MPI_Datatype datatype, MPI_Status *status)   30
int MPI_File_read_at_all_begin(MPI_File fh, MPI_Offset offset, void *buf, 32
                              int count, MPI_Datatype datatype)   33
int MPI_File_read_at_all_end(MPI_File fh, void *buf, MPI_Status *status) 34
int MPI_File_read_at_all(MPI_File fh, MPI_Offset offset, void *buf, 36
                        int count, MPI_Datatype datatype, MPI_Status *status) 37
int MPI_File_read_at(MPI_File fh, MPI_Offset offset, void *buf, int count, 38
                    MPI_Datatype datatype, MPI_Status *status)    39
int MPI_File_read(MPI_File fh, void *buf, int count, MPI_Datatype datatype, 41
                 MPI_Status *status)                              42
int MPI_File_read_ordered_begin(MPI_File fh, void *buf, int count, 43
                               MPI_Datatype datatype)            44
int MPI_File_read_ordered_end(MPI_File fh, void *buf, MPI_Status *status) 46

```

```

1  int MPI_File_read_ordered(MPI_File fh, void *buf, int count,
2      MPI_Datatype datatype, MPI_Status *status)
3
4  int MPI_File_read_shared(MPI_File fh, void *buf, int count,
5      MPI_Datatype datatype, MPI_Status *status)
6
7  int MPI_File_seek(MPI_File fh, MPI_Offset offset, int whence)
8
9  int MPI_File_seek_shared(MPI_File fh, MPI_Offset offset, int whence)
10
11 int MPI_File_set_atomicity(MPI_File fh, int flag)
12
13 int MPI_File_set_info(MPI_File fh, MPI_Info info)
14
15 int MPI_File_set_size(MPI_File fh, MPI_Offset size)
16
17 int MPI_File_set_view(MPI_File fh, MPI_Offset disp, MPI_Datatype etype,
18     MPI_Datatype filetype, const char *datarep, MPI_Info info)
19
20 int MPI_File_sync(MPI_File fh)
21
22 int MPI_File_write_all_begin(MPI_File fh, const void *buf, int count,
23     MPI_Datatype datatype)
24
25 int MPI_File_write_all_end(MPI_File fh, const void *buf,
26     MPI_Status *status)
27
28 int MPI_File_write_all(MPI_File fh, const void *buf, int count,
29     MPI_Datatype datatype, MPI_Status *status)
30
31 int MPI_File_write_at_all_begin(MPI_File fh, MPI_Offset offset, const
32     void *buf, int count, MPI_Datatype datatype)
33
34 int MPI_File_write_at_all_end(MPI_File fh, const void *buf,
35     MPI_Status *status)
36
37 int MPI_File_write_at_all(MPI_File fh, MPI_Offset offset, const void *buf,
38     int count, MPI_Datatype datatype, MPI_Status *status)
39
40 int MPI_File_write_at(MPI_File fh, MPI_Offset offset, const void *buf,
41     int count, MPI_Datatype datatype, MPI_Status *status)
42
43 int MPI_File_write(MPI_File fh, const void *buf, int count,
44     MPI_Datatype datatype, MPI_Status *status)
45
46 int MPI_File_write_ordered_begin(MPI_File fh, const void *buf, int count,
47     MPI_Datatype datatype)
48
49 int MPI_File_write_ordered_end(MPI_File fh, const void *buf,
50     MPI_Status *status)
51
52 int MPI_File_write_ordered(MPI_File fh, const void *buf, int count,
53     MPI_Datatype datatype, MPI_Status *status)
54
55 int MPI_File_write_shared(MPI_File fh, const void *buf, int count,
56     MPI_Datatype datatype, MPI_Status *status)

```

```

int MPI_Register_datarep(const char *datarep,
                        MPI_Datarep_conversion_function *read_conversion_fn,
                        MPI_Datarep_conversion_function *write_conversion_fn,
                        MPI_Datarep_extent_function *dtype_file_extent_fn,
                        void *extra_state)

```

1 ticket140.

2

3

4

5

6

7

A.2.12 Language Bindings C Bindings

8

```
int MPI_Status_f082f(MPI_F08_status *f08_status, MPI_Fint *f_status)
```

9

10

```
int MPI_Status_f2f08(MPI_Fint *f_status, MPI_F08_status *f08_status)
```

11

```
int MPI_Type_create_f90_complex(int p, int r, MPI_Datatype *newtype)
```

12

13

```
int MPI_Type_create_f90_integer(int r, MPI_Datatype *newtype)
```

14

```
int MPI_Type_create_f90_real(int p, int r, MPI_Datatype *newtype)
```

15

16

```
int MPI_Type_match_size(int typeclass, int size, MPI_Datatype *datatype)
```

17 ticket252-W.

```
MPI_Fint MPI_Comm_c2f(MPI_Comm comm)
```

18

19

```
MPI_Comm MPI_Comm_f2c(MPI_Fint comm)
```

20

```
MPI_Fint MPI_Errhandler_c2f(MPI_Errhandler errhandler)
```

21

22

```
MPI_Errhandler MPI_Errhandler_f2c(MPI_Fint errhandler)
```

23

```
MPI_Fint MPI_File_c2f(MPI_File file)
```

24

25

```
MPI_File MPI_File_f2c(MPI_Fint file)
```

26

```
MPI_Fint MPI_Group_c2f(MPI_Group group)
```

27

28

```
MPI_Group MPI_Group_f2c(MPI_Fint group)
```

29

```
MPI_Fint MPI_Info_c2f(MPI_Info info)
```

30

31

```
MPI_Info MPI_Info_f2c(MPI_Fint info)
```

32

```
MPI_Fint MPI_Message_c2f(MPI_Message message)
```

33

34

```
MPI_Message MPI_Message_f2c(MPI_Fint message)
```

35

36

```
MPI_Fint MPI_Op_c2f(MPI_Op op)
```

37

```
MPI_Op MPI_Op_f2c(MPI_Fint op)
```

38

39

```
MPI_Fint MPI_Request_c2f(MPI_Request request)
```

40

```
MPI_Request MPI_Request_f2c(MPI_Fint request)
```

41

42

```
int MPI_Status_c2f08(const MPI_Status *c_status, MPI_F08_status
                    *f08_status)
```

43 ticket140.

44

```
int MPI_Status_c2f(const MPI_Status *c_status, MPI_Fint *f_status)
```

45

ticket140.

46

```
int MPI_Status_f082c(const MPI_F08_status *f08_status, MPI_Status
                    *c_status)
```

47 ticket140.

48

```

ticket140. 1 int MPI_Status_f2c(const MPI_Fint *f_status, MPI_Status *c_status)
2
3 MPI_Fint MPI_Type_c2f(MPI_Datatype datatype)
4 MPI_Datatype MPI_Type_f2c(MPI_Fint datatype)
5
6 MPI_Fint MPI_Win_c2f(MPI_Win win)
7 MPI_Win MPI_Win_f2c(MPI_Fint win)
8
9
10 A.2.13 Profiling Interface C Bindings
11 int MPI_Pcontrol(const int level, ...)
12
13
14 A.2.14 Deprecated C Bindings
15
16 int MPI_Address(void* location, MPI_Aint *address)
17
18 int MPI_Attr_delete(MPI_Comm comm, int keyval)
19
20 int MPI_Attr_get(MPI_Comm comm, int keyval, void *attribute_val, int *flag)
21
22 int MPI_Attr_put(MPI_Comm comm, int keyval, void* attribute_val)
23
24 int MPI_DUP_FN(MPI_Comm oldcomm, int keyval, void *extra_state,
25               void *attribute_val_in, void *attribute_val_out, int *flag)
26
27 int MPI_Errhandler_create(MPI_Handler_function *[function]handler_fn,
28                           MPI_Errhandler *errhandler)
29
30 int MPI_Errhandler_get(MPI_Comm comm, MPI_Errhandler *errhandler)
31
32 int MPI_Errhandler_set(MPI_Comm comm, MPI_Errhandler errhandler)
33
34 int MPI_Keyval_create(MPI_Copy_function *copy_fn, MPI_Delete_function
35                       *delete_fn, int *keyval, void* extra_state)
36
37 int MPI_Keyval_free(int *keyval)
38
39 int MPI_NULL_COPY_FN(MPI_Comm oldcomm, int keyval, void *extra_state,
40                       void *attribute_val_in, void *attribute_val_out, int *flag)
41
42 int MPI_NULL_DELETE_FN(MPI_Comm comm, int keyval, void *attribute_val,
43                         void *extra_state)
44
45 int MPI_Type_extent(MPI_Datatype datatype, MPI_Aint *extent)
46
47 int MPI_Type_hindexed(int count, int *array_of_blocklengths,
48                       MPI_Aint *array_of_displacements, MPI_Datatype oldtype,
49                       MPI_Datatype *newtype)
50
51 int MPI_Type_hvector(int count, int blocklength, MPI_Aint stride,
52                     MPI_Datatype oldtype, MPI_Datatype *newtype)
53
54 int MPI_Type_lb(MPI_Datatype datatype, MPI_Aint* displacement)

```

```
int MPI_Type_struct(int count, int *array_of_blocklengths,
                   MPI_Aint *array_of_displacements,
                   MPI_Datatype *array_of_types, MPI_Datatype *newtype)
int MPI_Type_ub(MPI_Datatype datatype, MPI_Aint* displacement)
```

1
2
3
4
5
6
7
8
9
10
11
12
13
14
15
16
17
18
19
20
21
22
23
24
25
26
27
28
29
30
31
32
33
34
35
36
37
38
39
40
41
42
43
44
45
46
47
48

A.3 Fortran 2008 Bindings with the mpi_f08 Module

A.3.1 Point-to-Point Communication Fortran 2008 Bindings

```

MPI_Bsend(buf, count, datatype, dest, tag, comm, ierror) BIND(C)
  TYPE(*), DIMENSION(..), INTENT(IN) :: buf
  INTEGER, INTENT(IN) :: count, dest, tag
  TYPE(MPI_Datatype), INTENT(IN) :: datatype
  TYPE(MPI_Comm), INTENT(IN) :: comm
  INTEGER, OPTIONAL, INTENT(OUT) :: ierror

```

```

MPI_Bsend_init(buf, count, datatype, dest, tag, comm, request, ierror)
  BIND(C)
  TYPE(*), DIMENSION(..), INTENT(IN), ASYNCHRONOUS :: buf
  INTEGER, INTENT(IN) :: count, dest, tag
  TYPE(MPI_Datatype), INTENT(IN) :: datatype
  TYPE(MPI_Comm), INTENT(IN) :: comm
  TYPE(MPI_Request), INTENT(OUT) :: request
  INTEGER, OPTIONAL, INTENT(OUT) :: ierror

```

```

MPI_Buffer_attach(buffer, size, ierror) BIND(C)
  TYPE(*), DIMENSION(..), ASYNCHRONOUS :: buffer
  INTEGER, INTENT(IN) :: size
  INTEGER, OPTIONAL, INTENT(OUT) :: ierror

```

```

MPI_Buffer_detach(buffer_addr, size, ierror) BIND(C)
  USE, INTRINSIC :: ISO_C_BINDING, ONLY : C_PTR
  TYPE(C_PTR), INTENT(OUT) :: buffer_addr
  INTEGER, INTENT(OUT) :: size
  INTEGER, OPTIONAL, INTENT(OUT) :: ierror

```

```

MPI_Cancel(request, ierror) BIND(C)
  TYPE(MPI_Request), INTENT(IN) :: request
  INTEGER, OPTIONAL, INTENT(OUT) :: ierror

```

```

MPI_Get_count(status, datatype, count, ierror) BIND(C)
  TYPE(MPI_Status), INTENT(IN) :: status
  TYPE(MPI_Datatype), INTENT(IN) :: datatype
  INTEGER, INTENT(OUT) :: count
  INTEGER, OPTIONAL, INTENT(OUT) :: ierror

```

```

MPI_Ibsend(buf, count, datatype, dest, tag, comm, request, ierror) BIND(C)
  TYPE(*), DIMENSION(..), INTENT(IN), ASYNCHRONOUS :: buf
  INTEGER, INTENT(IN) :: count, dest, tag
  TYPE(MPI_Datatype), INTENT(IN) :: datatype
  TYPE(MPI_Comm), INTENT(IN) :: comm
  TYPE(MPI_Request), INTENT(OUT) :: request
  INTEGER, OPTIONAL, INTENT(OUT) :: ierror

```



```

MPI_Improbe(source, tag, comm, flag, message, status, ierror) BIND(C)      1
  INTEGER, INTENT(IN) :: source, tag                                     2
  TYPE(MPI_Comm), INTENT(IN) :: comm                                   3
  INTEGER, INTENT(OUT) :: flag                                       4
  TYPE(MPI_Message), INTENT(OUT) :: message                           5
  TYPE(MPI_Status) :: status                                          6
  INTEGER, OPTIONAL, INTENT(OUT) :: ierror                            7
                                                                    8 ticket-248T.
MPI_Imrecv(buf, count, datatype, message, request, ierror) BIND(C)      9
  TYPE(*), DIMENSION(..), ASYNCHRONOUS :: buf                         10
  INTEGER, INTENT(IN) :: count                                       11
  TYPE(MPI_Datatype), INTENT(IN) :: datatype                           12
  TYPE(MPI_Message), INTENT(INOUT) :: message                         13
  TYPE(MPI_Request), INTENT(OUT) :: request                           14
  INTEGER, OPTIONAL, INTENT(OUT) :: ierror                            15
                                                                    15 ticket-248T.
MPI_Iprobe(source, tag, comm, flag, status, ierror) BIND(C)             16
  INTEGER, INTENT(IN) :: source, tag                                  17
  TYPE(MPI_Comm), INTENT(IN) :: comm                                  18
  LOGICAL, INTENT(OUT) :: flag                                       19
  TYPE(MPI_Status) :: status                                          20
  INTEGER, OPTIONAL, INTENT(OUT) :: ierror                            21
                                                                    22 ticket-248T.
MPI_Irecv(buf, count, datatype, source, tag, comm, request, ierror) BIND(C) 23
  TYPE(*), DIMENSION(..), ASYNCHRONOUS :: buf                         24
  INTEGER, INTENT(IN) :: count, source, tag                           25
  TYPE(MPI_Datatype), INTENT(IN) :: datatype                           26
  TYPE(MPI_Comm), INTENT(IN) :: comm                                   27
  TYPE(MPI_Request), INTENT(OUT) :: request                           28
  INTEGER, OPTIONAL, INTENT(OUT) :: ierror                            29
                                                                    29 ticket-248T.
MPI_Irsend(buf, count, datatype, dest, tag, comm, request, ierror) BIND(C) 30
  TYPE(*), DIMENSION(..), INTENT(IN), ASYNCHRONOUS :: buf           31
  INTEGER, INTENT(IN) :: count, dest, tag                             32
  TYPE(MPI_Datatype), INTENT(IN) :: datatype                           33
  TYPE(MPI_Comm), INTENT(IN) :: comm                                   34
  TYPE(MPI_Request), INTENT(OUT) :: request                           35
  INTEGER, OPTIONAL, INTENT(OUT) :: ierror                            36
                                                                    37 ticket-248T.
MPI_Isend(buf, count, datatype, dest, tag, comm, request, ierror) BIND(C) 38
  TYPE(*), DIMENSION(..), INTENT(IN), ASYNCHRONOUS :: buf           39
  INTEGER, INTENT(IN) :: count, dest, tag                             40
  TYPE(MPI_Datatype), INTENT(IN) :: datatype                           41
  TYPE(MPI_Comm), INTENT(IN) :: comm                                   42
  TYPE(MPI_Request), INTENT(OUT) :: request                           43
  INTEGER, OPTIONAL, INTENT(OUT) :: ierror                            44
                                                                    44 ticket-248T.
MPI_Issend(buf, count, datatype, dest, tag, comm, request, ierror) BIND(C) 45
  TYPE(*), DIMENSION(..), INTENT(IN), ASYNCHRONOUS :: buf           46
  INTEGER, INTENT(IN) :: count, dest, tag                             47
                                                                    48

```

```

1      TYPE(MPI_Datatype), INTENT(IN) :: datatype
2      TYPE(MPI_Comm), INTENT(IN) :: comm
3      TYPE(MPI_Request), INTENT(OUT) :: request
4      INTEGER, OPTIONAL, INTENT(OUT) :: ierror
ticket-248T. 5
6      MPI_Mprobe(source, tag, comm, message, status, ierror) BIND(C)
7      INTEGER, INTENT(IN) :: source, tag
8      TYPE(MPI_Comm), INTENT(IN) :: comm
9      TYPE(MPI_Message), INTENT(OUT) :: message
10     TYPE(MPI_Status) :: status
ticket-248T. 11
12     MPI_Mrecv(buf, count, datatype, message, status, ierror) BIND(C)
13     TYPE(*), DIMENSION(..) :: buf
14     INTEGER, INTENT(IN) :: count
15     TYPE(MPI_Datatype), INTENT(IN) :: datatype
16     TYPE(MPI_Message), INTENT(INOUT) :: message
17     TYPE(MPI_Status) :: status
18     INTEGER, OPTIONAL, INTENT(OUT) :: ierror
ticket-248T. 19
20     MPI_Probe(source, tag, comm, status, ierror) BIND(C)
21     INTEGER, INTENT(IN) :: source, tag
22     TYPE(MPI_Comm), INTENT(IN) :: comm
23     TYPE(MPI_Status) :: status
24     INTEGER, OPTIONAL, INTENT(OUT) :: ierror
ticket-248T. 25
26     MPI_Recv(buf, count, datatype, source, tag, comm, status, ierror) BIND(C)
27     TYPE(*), DIMENSION(..) :: buf
28     INTEGER, INTENT(IN) :: count, source, tag
29     TYPE(MPI_Datatype), INTENT(IN) :: datatype
30     TYPE(MPI_Comm), INTENT(IN) :: comm
31     TYPE(MPI_Status) :: status
32     INTEGER, OPTIONAL, INTENT(OUT) :: ierror
ticket-248T. 33
34     MPI_Recv_init(buf, count, datatype, source, tag, comm, request, ierror)
35     BIND(C)
36     TYPE(*), DIMENSION(..), ASYNCHRONOUS :: buf
37     INTEGER, INTENT(IN) :: count, source, tag
38     TYPE(MPI_Datatype), INTENT(IN) :: datatype
39     TYPE(MPI_Comm), INTENT(IN) :: comm
40     TYPE(MPI_Request), INTENT(OUT) :: request
41     INTEGER, OPTIONAL, INTENT(OUT) :: ierror
ticket-248T. 42
43     MPI_Request_free(request, ierror) BIND(C)
44     TYPE(MPI_Request), INTENT(INOUT) :: request
45     INTEGER, OPTIONAL, INTENT(OUT) :: ierror
ticket-248T. 46
47     MPI_Request_get_status(request, flag, status, ierror) BIND(C)
48     TYPE(MPI_Request), INTENT(IN) :: request
49     LOGICAL, INTENT(OUT) :: flag
50     TYPE(MPI_Status) :: status

```

```

    INTEGER, OPTIONAL, INTENT(OUT) :: ierror
1
2 ticket-248T.
MPI_Rsend(buf, count, datatype, dest, tag, comm, ierror) BIND(C)
3
4
5
6
7
8 ticket-248T.
MPI_Rsend_init(buf, count, datatype, dest, tag, comm, request, ierror)
9
10
11
12
13
14
15
16
17 ticket-248T.
MPI_Send(buf, count, datatype, dest, tag, comm, ierror) BIND(C)
18
19
20
21
22
23
24 ticket-248T.
MPI_Send_init(buf, count, datatype, dest, tag, comm, request, ierror)
25
26
27
28
29
30
31
32 ticket-248T.
MPI_Sendrecv_replace(buf, count, datatype, dest, sendtag, source, recvtag,
33
34
35
36
37
38
39
40
41 ticket-248T.
    comm, status, ierror) BIND(C)
42
43
44
45
46
47
48
MPI_Sendrecv(sendbuf, sendcount, sendtype, dest, sendtag, recvbuf,
    recvcount, recvtype, source, recvtag, comm, status, ierror)
    BIND(C)
    TYPE(*), DIMENSION(..), INTENT(IN) :: sendbuf
    TYPE(*), DIMENSION(..) :: recvbuf
    INTEGER, INTENT(IN) :: sendcount, dest, sendtag, recvcount, source,
    recvtag

```

```

1      TYPE(MPI_Datatype), INTENT(IN) :: sendtype, recvtype
2      TYPE(MPI_Comm), INTENT(IN) :: comm
3      TYPE(MPI_Status) :: status
4      INTEGER, OPTIONAL, INTENT(OUT) :: ierror
ticket-248T. 5
6      MPI_Ssend(buf, count, datatype, dest, tag, comm, ierror) BIND(C)
7      TYPE(*), DIMENSION(..), INTENT(IN) :: buf
8      INTEGER, INTENT(IN) :: count, dest, tag
9      TYPE(MPI_Datatype), INTENT(IN) :: datatype
10     TYPE(MPI_Comm), INTENT(IN) :: comm
ticket-248T. 11
12     MPI_Ssend_init(buf, count, datatype, dest, tag, comm, request, ierror)
13         BIND(C)
14     TYPE(*), DIMENSION(..), INTENT(IN), ASYNCHRONOUS :: buf
15     INTEGER, INTENT(IN) :: count, dest, tag
16     TYPE(MPI_Datatype), INTENT(IN) :: datatype
17     TYPE(MPI_Comm), INTENT(IN) :: comm
18     TYPE(MPI_Request), INTENT(OUT) :: request
19     INTEGER, OPTIONAL, INTENT(OUT) :: ierror
ticket-248T. 20
21     MPI_Startall(count, array_of_requests, ierror) BIND(C)
22     INTEGER, INTENT(IN) :: count
23     TYPE(MPI_Request), INTENT(INOUT) :: array_of_requests(count)
24     INTEGER, OPTIONAL, INTENT(OUT) :: ierror
ticket-248T. 25
26     MPI_Start(request, ierror) BIND(C)
27     TYPE(MPI_Request), INTENT(INOUT) :: request
28     INTEGER, OPTIONAL, INTENT(OUT) :: ierror
ticket-248T. 29
30     MPI_Testall(count, array_of_requests, flag, array_of_statuses, ierror)
31         BIND(C)
32     INTEGER, INTENT(IN) :: count
33     TYPE(MPI_Request), INTENT(INOUT) :: array_of_requests(count)
34     LOGICAL, INTENT(OUT) :: flag
35     TYPE(MPI_Status) :: array_of_statuses(*)
36     INTEGER, OPTIONAL, INTENT(OUT) :: ierror
ticket-248T. 37
38     MPI_Testany(count, array_of_requests, index, flag, status, ierror) BIND(C)
39     INTEGER, INTENT(IN) :: count
40     TYPE(MPI_Request), INTENT(INOUT) :: array_of_requests(count)
41     INTEGER, INTENT(OUT) :: index
42     LOGICAL, INTENT(OUT) :: flag
43     TYPE(MPI_Status) :: status
44     INTEGER, OPTIONAL, INTENT(OUT) :: ierror
ticket-248T. 45
46     MPI_Test_cancelled(status, flag, ierror) BIND(C)
47     TYPE(MPI_Status), INTENT(IN) :: status
48     LOGICAL, INTENT(OUT) :: flag
49     INTEGER, OPTIONAL, INTENT(OUT) :: ierror

```

```

MPI_Test(request, flag, status, ierror) BIND(C)
  TYPE(MPI_Request), INTENT(INOUT) :: request
  LOGICAL, INTENT(OUT) :: flag
  TYPE(MPI_Status) :: status
  INTEGER, OPTIONAL, INTENT(OUT) :: ierror

MPI_Testsome(incount, array_of_requests, outcount, array_of_indices,
             array_of_statuses, ierror) BIND(C)
  INTEGER, INTENT(IN) :: incount
  TYPE(MPI_Request), INTENT(INOUT) :: array_of_requests(incount)
  INTEGER, INTENT(OUT) :: outcount, array_of_indices(*)
  TYPE(MPI_Status) :: array_of_statuses(*)
  INTEGER, OPTIONAL, INTENT(OUT) :: ierror

MPI_Waitall(count, array_of_requests, array_of_statuses, ierror) BIND(C)
  INTEGER, INTENT(IN) :: count
  TYPE(MPI_Request), INTENT(INOUT) :: array_of_requests(count)
  TYPE(MPI_Status) :: array_of_statuses(*)
  INTEGER, OPTIONAL, INTENT(OUT) :: ierror

MPI_Waitany(count, array_of_requests, index, status, ierror) BIND(C)
  INTEGER, INTENT(IN) :: count
  TYPE(MPI_Request), INTENT(INOUT) :: array_of_requests(count)
  INTEGER, INTENT(OUT) :: index
  TYPE(MPI_Status) :: status
  INTEGER, OPTIONAL, INTENT(OUT) :: ierror

MPI_Wait(request, status, ierror) BIND(C)
  TYPE(MPI_Request), INTENT(INOUT) :: request
  TYPE(MPI_Status) :: status
  INTEGER, OPTIONAL, INTENT(OUT) :: ierror

MPI_Waitsome(incount, array_of_requests, outcount, array_of_indices,
             array_of_statuses, ierror) BIND(C)
  INTEGER, INTENT(IN) :: incount
  TYPE(MPI_Request), INTENT(INOUT) :: array_of_requests(incount)
  INTEGER, INTENT(OUT) :: outcount, array_of_indices(*)
  TYPE(MPI_Status) :: array_of_statuses(*)
  INTEGER, OPTIONAL, INTENT(OUT) :: ierror

A.3.2 Datatypes Fortran 2008 Bindings

MPI_Get_address(location, address, ierror) BIND(C)
  TYPE(*), DIMENSION(..), ASYNCHRONOUS :: location
  INTEGER(KIND=MPI_ADDRESS_KIND), INTENT(OUT) :: address
  INTEGER, OPTIONAL, INTENT(OUT) :: ierror

MPI_Get_elements(status, datatype, count, ierror) BIND(C)
  TYPE(MPI_Status), INTENT(IN) :: status
  TYPE(MPI_Datatype), INTENT(IN) :: datatype

```

```

1      INTEGER, INTENT(OUT) :: count
2      INTEGER, OPTIONAL, INTENT(OUT) :: ierror
ticket-248T. 3
4      MPI_Get_elements_x(status, datatype, count, ierror) BIND(C)
5      TYPE(MPI_Status), INTENT(IN) :: status
6      TYPE(MPI_Datatype), INTENT(IN) :: datatype
7      INTEGER(KIND = MPI_COUNT_KIND), INTENT(OUT) :: count
8      INTEGER, OPTIONAL, INTENT(OUT) :: ierror
ticket-248T. 9
10     MPI_Pack_external(datarep, inbuf, incount, datatype, outbuf, outsize,
11         position, ierror) BIND(C)
12     CHARACTER(LEN=*), INTENT(IN) :: datarep
13     TYPE(*), DIMENSION(..), INTENT(IN) :: inbuf
14     TYPE(*), DIMENSION(..) :: outbuf
15     INTEGER, INTENT(IN) :: incount
16     TYPE(MPI_Datatype), INTENT(IN) :: datatype
17     INTEGER(KIND=MPI_ADDRESS_KIND), INTENT(IN) :: outsize
18     INTEGER(KIND=MPI_ADDRESS_KIND), INTENT(INOUT) :: position
19     INTEGER, OPTIONAL, INTENT(OUT) :: ierror
ticket-248T. 20
21     MPI_Pack_external_size(datarep, incount, datatype, size, ierror) BIND(C)
22     TYPE(MPI_Datatype), INTENT(IN) :: datatype
23     INTEGER, INTENT(IN) :: incount
24     CHARACTER(LEN=*), INTENT(IN) :: datarep
25     INTEGER(KIND=MPI_ADDRESS_KIND), INTENT(OUT) :: size
26     INTEGER, OPTIONAL, INTENT(OUT) :: ierror
ticket-248T. 27
28     MPI_Pack(inbuf, incount, datatype, outbuf, outsize, position, comm, ierror)
29         BIND(C)
30     TYPE(*), DIMENSION(..), INTENT(IN) :: inbuf
31     TYPE(*), DIMENSION(..) :: outbuf
32     INTEGER, INTENT(IN) :: incount, outsize
33     TYPE(MPI_Datatype), INTENT(IN) :: datatype
34     INTEGER, INTENT(INOUT) :: position
35     TYPE(MPI_Comm), INTENT(IN) :: comm
36     INTEGER, OPTIONAL, INTENT(OUT) :: ierror
ticket-248T. 37
38     MPI_Pack_size(incount, datatype, comm, size, ierror) BIND(C)
39     INTEGER, INTENT(IN) :: incount
40     TYPE(MPI_Datatype), INTENT(IN) :: datatype
41     TYPE(MPI_Comm), INTENT(IN) :: comm
42     INTEGER, INTENT(OUT) :: size
43     INTEGER, OPTIONAL, INTENT(OUT) :: ierror
ticket-248T. 44
45     MPI_Type_commit(datatype, ierror) BIND(C)
46     TYPE(MPI_Datatype), INTENT(INOUT) :: datatype
47     INTEGER, OPTIONAL, INTENT(OUT) :: ierror
ticket-248T. 48
49     MPI_Type_contiguous(count, oldtype, newtype, ierror) BIND(C)
50     INTEGER, INTENT(IN) :: count
51     TYPE(MPI_Datatype), INTENT(IN) :: oldtype

```

```

TYPE(MPI_Datatype), INTENT(OUT) :: newtype
INTEGER, OPTIONAL, INTENT(OUT) :: ierror
MPI_Type_create_darray(size, rank, ndims, array_of_gsizes,
    array_of_distribs, array_of_dargs, array_of_psizes, order,
    oldtype, newtype, ierror) BIND(C)
INTEGER, INTENT(IN) :: size, rank, ndims, array_of_gsizes(ndims),
array_of_distribs(ndims), array_of_dargs(ndims),
array_of_psizes(ndims), order
TYPE(MPI_Datatype), INTENT(IN) :: oldtype
TYPE(MPI_Datatype), INTENT(OUT) :: newtype
INTEGER, OPTIONAL, INTENT(OUT) :: ierror
MPI_Type_create_hindexed_block(count, blocklength, array_of_displacements,
    oldtype, newtype, ierror) BIND(C)
INTEGER, INTENT(IN) :: count, blocklength
INTEGER(KIND=MPI_Address_kind), INTENT(IN) ::
array_of_displacements(count)
TYPE(MPI_Datatype), INTENT(IN) :: oldtype
TYPE(MPI_Datatype), INTENT(OUT) :: newtype
INTEGER, OPTIONAL, INTENT(OUT) :: ierror
MPI_Type_create_hindexed(count, array_of_blocklengths,
    array_of_displacements, oldtype, newtype, ierror) BIND(C)
INTEGER, INTENT(IN) :: count, array_of_blocklengths(count)
INTEGER(KIND=MPI_ADDRESS_KIND), INTENT(IN) ::
array_of_displacements(count)
TYPE(MPI_Datatype), INTENT(IN) :: oldtype
TYPE(MPI_Datatype), INTENT(OUT) :: newtype
INTEGER, OPTIONAL, INTENT(OUT) :: ierror
MPI_Type_create_hvector(count, blocklength, stride, oldtype, newtype,
    ierror) BIND(C)
INTEGER, INTENT(IN) :: count, blocklength
INTEGER(KIND=MPI_ADDRESS_KIND), INTENT(IN) :: stride
TYPE(MPI_Datatype), INTENT(IN) :: oldtype
TYPE(MPI_Datatype), INTENT(OUT) :: newtype
INTEGER, OPTIONAL, INTENT(OUT) :: ierror
MPI_Type_create_indexed_block(count, blocklength, array_of_displacements,
    oldtype, newtype, ierror) BIND(C)
INTEGER, INTENT(IN) :: count, blocklength,
array_of_displacements(count)
TYPE(MPI_Datatype), INTENT(IN) :: oldtype
TYPE(MPI_Datatype), INTENT(OUT) :: newtype
INTEGER, OPTIONAL, INTENT(OUT) :: ierror
MPI_Type_create_resized(oldtype, lb, extent, newtype, ierror) BIND(C)
INTEGER(KIND=MPI_ADDRESS_KIND), INTENT(IN) :: lb, extent
TYPE(MPI_Datatype), INTENT(IN) :: oldtype

```

```

1      TYPE(MPI_Datatype), INTENT(OUT) :: newtype
2      INTEGER, OPTIONAL, INTENT(OUT) :: ierror
ticket-248T. 3
4      MPI_Type_create_struct(count, array_of_blocklengths,
5          array_of_displacements, array_of_types, newtype, ierror)
6          BIND(C)
7      INTEGER, INTENT(IN) :: count, array_of_blocklengths(count)
8      INTEGER(KIND=MPI_ADDRESS_KIND), INTENT(IN) ::
9      array_of_displacements(count)
10     TYPE(MPI_Datatype), INTENT(IN) :: array_of_types(count)
11     TYPE(MPI_Datatype), INTENT(OUT) :: newtype
ticket-248T. 12
13     MPI_Type_create_subarray(ndims, array_of_sizes, array_of_subsizes,
14         array_of_starts, order, oldtype, newtype, ierror) BIND(C)
15     INTEGER, INTENT(IN) :: ndims, array_of_sizes(ndims),
16     array_of_subsizes(ndims), array_of_starts(ndims), order
17     TYPE(MPI_Datatype), INTENT(IN) :: oldtype
18     TYPE(MPI_Datatype), INTENT(OUT) :: newtype
ticket-248T. 19
20     INTEGER, OPTIONAL, INTENT(OUT) :: ierror
21     MPI_Type_dup(oldtype, newtype, ierror) BIND(C)
22     TYPE(MPI_Datatype), INTENT(IN) :: oldtype
23     TYPE(MPI_Datatype), INTENT(OUT) :: newtype
ticket-248T. 24
25     INTEGER, OPTIONAL, INTENT(OUT) :: ierror
26     MPI_Type_free(datatype, ierror) BIND(C)
27     TYPE(MPI_Datatype), INTENT(INOUT) :: datatype
ticket-248T. 28
29     INTEGER, OPTIONAL, INTENT(OUT) :: ierror
30     MPI_Type_get_contents(datatype, max_integers, max_addresses, max_datatypes,
31     array_of_integers, array_of_addresses, array_of_datatypes,
32     ierror) BIND(C)
33     TYPE(MPI_Datatype), INTENT(IN) :: datatype
34     INTEGER, INTENT(IN) :: max_integers, max_addresses, max_datatypes
35     INTEGER, INTENT(OUT) :: array_of_integers(max_integers)
36     INTEGER(KIND=MPI_ADDRESS_KIND), INTENT(OUT) ::
37     array_of_addresses(max_addresses)
38     TYPE(MPI_Datatype), INTENT(OUT) :: array_of_datatypes(max_datatypes)
ticket-248T. 39
40     INTEGER, OPTIONAL, INTENT(OUT) :: ierror
41     MPI_Type_get_envelope(datatype, num_integers, num_addresses, num_datatypes,
42     combiner, ierror) BIND(C)
43     TYPE(MPI_Datatype), INTENT(IN) :: datatype
44     INTEGER, INTENT(OUT) :: num_integers, num_addresses, num_datatypes,
45     combiner
ticket-248T. 46
47     INTEGER, OPTIONAL, INTENT(OUT) :: ierror
48     MPI_Type_get_extent(datatype, lb, extent, ierror) BIND(C)
49     TYPE(MPI_Datatype), INTENT(IN) :: datatype
50     INTEGER(KIND=MPI_ADDRESS_KIND), INTENT(OUT) :: lb, extent

```



```

    INTEGER, OPTIONAL, INTENT(OUT) :: ierror
MPI_Type_get_true_extent(datatype, true_lb, true_extent, ierror) BIND(C)
    TYPE(MPI_Datatype), INTENT(IN) :: datatype
    INTEGER(KIND=MPI_ADDRESS_KIND), INTENT(OUT) :: true_lb, true_extent
    INTEGER, OPTIONAL, INTENT(OUT) :: ierror
MPI_Type_indexed(count, array_of_blocklengths, array_of_displacements,
    oldtype, newtype, ierror) BIND(C)
    INTEGER, INTENT(IN) :: count, array_of_blocklengths(count),
    array_of_displacements(count)
    TYPE(MPI_Datatype), INTENT(IN) :: oldtype
    TYPE(MPI_Datatype), INTENT(OUT) :: newtype
    INTEGER, OPTIONAL, INTENT(OUT) :: ierror
MPI_Type_size(datatype, size, ierror) BIND(C)
    TYPE(MPI_Datatype), INTENT(IN) :: datatype
    INTEGER, INTENT(OUT) :: size
    INTEGER, OPTIONAL, INTENT(OUT) :: ierror
MPI_Type_vector(count, blocklength, stride, oldtype, newtype, ierror)
    BIND(C)
    INTEGER, INTENT(IN) :: count, blocklength, stride
    TYPE(MPI_Datatype), INTENT(IN) :: oldtype
    TYPE(MPI_Datatype), INTENT(OUT) :: newtype
    INTEGER, OPTIONAL, INTENT(OUT) :: ierror
MPI_Unpack_external(datarep, inbuf, insize, position, outbuf, outcount,
    datatype, ierror) BIND(C)
    CHARACTER(LEN=*), INTENT(IN) :: datarep
    TYPE(*), DIMENSION(..), INTENT(IN) :: inbuf
    TYPE(*), DIMENSION(..) :: outbuf
    INTEGER(KIND=MPI_ADDRESS_KIND), INTENT(IN) :: insize
    INTEGER(KIND=MPI_ADDRESS_KIND), INTENT(INOUT) :: position
    INTEGER, INTENT(IN) :: outcount
    TYPE(MPI_Datatype), INTENT(IN) :: datatype
    INTEGER, OPTIONAL, INTENT(OUT) :: ierror
MPI_Unpack(inbuf, insize, position, outbuf, outcount, datatype, comm,
    ierror) BIND(C)
    TYPE(*), DIMENSION(..), INTENT(IN) :: inbuf
    TYPE(*), DIMENSION(..) :: outbuf
    INTEGER, INTENT(IN) :: insize, outcount
    INTEGER, INTENT(INOUT) :: position
    TYPE(MPI_Datatype), INTENT(IN) :: datatype
    TYPE(MPI_Comm), INTENT(IN) :: comm
    INTEGER, OPTIONAL, INTENT(OUT) :: ierror

```

A.3.3 Collective Communication Fortran 2008 Bindings

1
2 ticket-248T.
3
4
5
6 ticket-248T.
7
8
9
10
11
12
13
14 ticket-248T.
15
16
17
18 ticket-248T.
19
20
21
22
23
24
25 ticket-248T.
26
27
28
29
30
31
32
33
34
35 ticket-248T.
36
37
38
39
40
41
42
43
44
45
46
47
48 ticket-248T.

```

1 MPI_Allgather(sendbuf, sendcount, sendtype, recvbuf, recvcount, recvtype,
2               comm, ierror) BIND(C)
3     TYPE(*), DIMENSION(..), INTENT(IN) :: sendbuf
4     TYPE(*), DIMENSION(..) :: recvbuf
5     INTEGER, INTENT(IN) :: sendcount, recvcount
6     TYPE(MPI_Datatype), INTENT(IN) :: sendtype, recvtype
7     TYPE(MPI_Comm), INTENT(IN) :: comm
8     INTEGER, OPTIONAL, INTENT(OUT) :: ierror
ticket-248T.
9 MPI_Allgatherv(sendbuf, sendcount, sendtype, recvbuf, recvcounts, displs,
10               recvtype, comm, ierror) BIND(C)
11     TYPE(*), DIMENSION(..), INTENT(IN) :: sendbuf
12     TYPE(*), DIMENSION(..) :: recvbuf
13     INTEGER, INTENT(IN) :: sendcount, recvcounts(*), displs(*)
14     TYPE(MPI_Datatype), INTENT(IN) :: sendtype, recvtype
15     TYPE(MPI_Comm), INTENT(IN) :: comm
16     INTEGER, OPTIONAL, INTENT(OUT) :: ierror
ticket-248T.
17 MPI_Allreduce(sendbuf, recvbuf, count, datatype, op, comm, ierror) BIND(C)
18     TYPE(*), DIMENSION(..), INTENT(IN) :: sendbuf
19     TYPE(*), DIMENSION(..) :: recvbuf
20     INTEGER, INTENT(IN) :: count
21     TYPE(MPI_Datatype), INTENT(IN) :: datatype
22     TYPE(MPI_Op), INTENT(IN) :: op
23     TYPE(MPI_Comm), INTENT(IN) :: comm
24     INTEGER, OPTIONAL, INTENT(OUT) :: ierror
ticket-248T.
25 MPI_Alltoall(sendbuf, sendcount, sendtype, recvbuf, recvcount, recvtype,
26               comm, ierror) BIND(C)
27     TYPE(*), DIMENSION(..), INTENT(IN) :: sendbuf
28     TYPE(*), DIMENSION(..) :: recvbuf
29     INTEGER, INTENT(IN) :: sendcount, recvcount
30     TYPE(MPI_Datatype), INTENT(IN) :: sendtype, recvtype
31     TYPE(MPI_Comm), INTENT(IN) :: comm
32     INTEGER, OPTIONAL, INTENT(OUT) :: ierror
ticket-248T.
33 MPI_Alltoallv(sendbuf, sendcounts, sdispls, sendtype, recvbuf, recvcounts,
34               rdispls, recvtype, comm, ierror) BIND(C)
35     TYPE(*), DIMENSION(..), INTENT(IN) :: sendbuf
36     TYPE(*), DIMENSION(..) :: recvbuf
37     INTEGER, INTENT(IN) :: sendcounts(*), sdispls(*), recvcounts(*),
38     rdispls(*)
39     TYPE(MPI_Datatype), INTENT(IN) :: sendtype, recvtype
40     TYPE(MPI_Comm), INTENT(IN) :: comm
41     INTEGER, OPTIONAL, INTENT(OUT) :: ierror
ticket-248T.
42 MPI_Alltoallw(sendbuf, sendcounts, sdispls, sendtypes, recvbuf, recvcounts,
43               rdispls, recvtypes, comm, ierror) BIND(C)
44     TYPE(*), DIMENSION(..), INTENT(IN) :: sendbuf
45     TYPE(*), DIMENSION(..) :: recvbuf
46     TYPE(*), DIMENSION(..), INTENT(IN) :: sendtypes
47     TYPE(*), DIMENSION(..), INTENT(IN) :: recvtypes
48     INTEGER, OPTIONAL, INTENT(OUT) :: ierror

```

```

    INTEGER, INTENT(IN) :: sendcounts(*), sdispls(*), recvcounts(*),
    rdispls(*)
    TYPE(MPI_Datatype), INTENT(IN) :: sendtypes(*)
    TYPE(MPI_Datatype), INTENT(IN) :: recvtypes(*)
    TYPE(MPI_Comm), INTENT(IN) :: comm
    INTEGER, OPTIONAL, INTENT(OUT) :: ierror
MPI_Barrier(comm, ierror) BIND(C)
    TYPE(MPI_Comm), INTENT(IN) :: comm
    INTEGER, OPTIONAL, INTENT(OUT) :: ierror
MPI_Bcast(buffer, count, datatype, root, comm, ierror) BIND(C)
    TYPE(*), DIMENSION(..) :: buffer
    INTEGER, INTENT(IN) :: count, root
    TYPE(MPI_Datatype), INTENT(IN) :: datatype
    TYPE(MPI_Comm), INTENT(IN) :: comm
    INTEGER, OPTIONAL, INTENT(OUT) :: ierror
MPI_Exscan(sendbuf, recvbuf, count, datatype, op, comm, ierror) BIND(C)
    TYPE(*), DIMENSION(..), INTENT(IN) :: sendbuf
    TYPE(*), DIMENSION(..) :: recvbuf
    INTEGER, INTENT(IN) :: count
    TYPE(MPI_Datatype), INTENT(IN) :: datatype
    TYPE(MPI_Op), INTENT(IN) :: op
    TYPE(MPI_Comm), INTENT(IN) :: comm
    INTEGER, OPTIONAL, INTENT(OUT) :: ierror
MPI_Gather(sendbuf, sendcount, sendtype, recvbuf, recvcount, recvtype,
           root, comm, ierror) BIND(C)
    TYPE(*), DIMENSION(..), INTENT(IN) :: sendbuf
    TYPE(*), DIMENSION(..) :: recvbuf
    INTEGER, INTENT(IN) :: sendcount, recvcount, root
    TYPE(MPI_Datatype), INTENT(IN) :: sendtype, recvtype
    TYPE(MPI_Comm), INTENT(IN) :: comm
    INTEGER, OPTIONAL, INTENT(OUT) :: ierror
MPI_Gatherv(sendbuf, sendcount, sendtype, recvbuf, recvcounts, displs,
            recvtype, root, comm, ierror) BIND(C)
    TYPE(*), DIMENSION(..), INTENT(IN) :: sendbuf
    TYPE(*), DIMENSION(..) :: recvbuf
    INTEGER, INTENT(IN) :: sendcount, recvcounts(*), displs(*), root
    TYPE(MPI_Datatype), INTENT(IN) :: sendtype, recvtype
    TYPE(MPI_Comm), INTENT(IN) :: comm
    INTEGER, OPTIONAL, INTENT(OUT) :: ierror
MPI_Iallgather(sendbuf, sendcount, sendtype, recvbuf, recvcount, recvtype,
              comm, request, ierror) BIND(C)
    TYPE(*), DIMENSION(..), INTENT(IN), ASYNCHRONOUS :: sendbuf
    TYPE(*), DIMENSION(..), ASYNCHRONOUS :: recvbuf
    INTEGER, INTENT(IN) :: sendcount, recvcount

```

```

1      TYPE(MPI_Datatype), INTENT(IN) :: sendtype, recvtype
2      TYPE(MPI_Comm), INTENT(IN) :: comm
3      TYPE(MPI_Request), INTENT(OUT) :: request
4      INTEGER, OPTIONAL, INTENT(OUT) :: ierror
ticket-248T. 5
6      MPI_Iallgatherv(sendbuf, sendcount, sendtype, recvbuf, recvcnts, displs,
7                  recvtype, comm, request, ierror) BIND(C)
8      TYPE(*), DIMENSION(..), INTENT(IN), ASYNCHRONOUS :: sendbuf
9      TYPE(*), DIMENSION(..), ASYNCHRONOUS :: recvbuf
10     INTEGER, INTENT(IN) :: sendcount
11     INTEGER, INTENT(IN), ASYNCHRONOUS :: recvcnts(*), displs(*)
12     TYPE(MPI_Datatype), INTENT(IN) :: sendtype, recvtype
13     TYPE(MPI_Comm), INTENT(IN) :: comm
14     TYPE(MPI_Request), INTENT(OUT) :: request
ticket-248T. 15
16     MPI_Iallreduce(sendbuf, recvbuf, count, datatype, op, comm, request,
17                  ierror) BIND(C)
18     TYPE(*), DIMENSION(..), INTENT(IN), ASYNCHRONOUS :: sendbuf
19     TYPE(*), DIMENSION(..), ASYNCHRONOUS :: recvbuf
20     INTEGER, INTENT(IN) :: count
21     TYPE(MPI_Datatype), INTENT(IN) :: datatype
22     TYPE(MPI_Op), INTENT(IN) :: op
23     TYPE(MPI_Comm), INTENT(IN) :: comm
24     TYPE(MPI_Request), INTENT(OUT) :: request
ticket-248T. 25
26     MPI_Ialltoall(sendbuf, sendcount, sendtype, recvbuf, recvcnt, recvtype,
27                  comm, request, ierror) BIND(C)
28     TYPE(*), DIMENSION(..), INTENT(IN), ASYNCHRONOUS :: sendbuf
29     TYPE(*), DIMENSION(..), ASYNCHRONOUS :: recvbuf
30     INTEGER, INTENT(IN) :: sendcount, recvcnt
31     TYPE(MPI_Datatype), INTENT(IN) :: sendtype, recvtype
32     TYPE(MPI_Comm), INTENT(IN) :: comm
33     TYPE(MPI_Request), INTENT(OUT) :: request
ticket-248T. 35
36     MPI_Ialltoallv(sendbuf, sendcounts, sdispls, sendtype, recvbuf, recvcnts,
37                  rdispls, recvtype, comm, request, ierror) BIND(C)
38     TYPE(*), DIMENSION(..), INTENT(IN), ASYNCHRONOUS :: sendbuf
39     TYPE(*), DIMENSION(..), ASYNCHRONOUS :: recvbuf
40     INTEGER, INTENT(IN), ASYNCHRONOUS :: sendcounts(*), sdispls(*),
41     recvcnts(*), rdispls(*)
42     TYPE(MPI_Datatype), INTENT(IN) :: sendtype, recvtype
43     TYPE(MPI_Comm), INTENT(IN) :: comm
44     TYPE(MPI_Request), INTENT(OUT) :: request
ticket-248T. 46
47     MPI_Ialltoallw(sendbuf, sendcounts, sdispls, sendtypes, recvbuf,
48                  recvcnts, rdispls, recvtypes, comm, request, ierror) BIND(C)

```

```

TYPE(*), DIMENSION(..), INTENT(IN), ASYNCHRONOUS :: sendbuf      1
TYPE(*), DIMENSION(..), ASYNCHRONOUS :: recvbuf                2
INTEGER, INTENT(IN), ASYNCHRONOUS :: sendcounts(*), sdispls(*),  3
recvcounts(*), rdispls(*)                                       4
TYPE(MPI_Datatype), INTENT(IN), ASYNCHRONOUS :: sendtypes(*),   5
recvtypes(*)                                                    6
TYPE(MPI_Comm), INTENT(IN) :: comm                               7
TYPE(MPI_Request), INTENT(OUT) :: request                       8
INTEGER, OPTIONAL, INTENT(OUT) :: ierror                       9
10 ticket-248T.
MPI_Ibarrier(comm, request, ierror) BIND(C)                     11
  TYPE(MPI_Comm), INTENT(IN) :: comm                             12
  TYPE(MPI_Request), INTENT(OUT) :: request                      13
  INTEGER, OPTIONAL, INTENT(OUT) :: ierror                      14
14 ticket-248T.
MPI_Ibcast(buffer, count, datatype, root, comm, request, ierror) BIND(C) 15
  TYPE(*), DIMENSION(..), ASYNCHRONOUS :: buffer              16
  INTEGER, INTENT(IN) :: count, root                          17
  TYPE(MPI_Datatype), INTENT(IN) :: datatype                  18
  TYPE(MPI_Comm), INTENT(IN) :: comm                          19
  TYPE(MPI_Request), INTENT(OUT) :: request                  20
  INTEGER, OPTIONAL, INTENT(OUT) :: ierror                   21
21 ticket-248T.
MPI_Iexscan(sendbuf, recvbuf, count, datatype, op, comm, request, ierror) 22
  BIND(C)                                                       23
  TYPE(*), DIMENSION(..), INTENT(IN), ASYNCHRONOUS :: sendbuf 24
  TYPE(*), DIMENSION(..), ASYNCHRONOUS :: recvbuf            25
  INTEGER, INTENT(IN) :: count                                26
  TYPE(MPI_Datatype), INTENT(IN) :: datatype                 27
  TYPE(MPI_Op), INTENT(IN) :: op                             28
  TYPE(MPI_Comm), INTENT(IN) :: comm                         29
  TYPE(MPI_Request), INTENT(OUT) :: request                  30
  INTEGER, OPTIONAL, INTENT(OUT) :: ierror                   31
31 ticket-248T.
MPI_Igather(sendbuf, sendcount, sendtype, recvbuf, recvcount, recvttype, 32
  root, comm, request, ierror) BIND(C)                          33
  TYPE(*), DIMENSION(..), INTENT(IN), ASYNCHRONOUS :: sendbuf 34
  TYPE(*), DIMENSION(..), ASYNCHRONOUS :: recvbuf            35
  INTEGER, INTENT(IN) :: sendcount, recvcount, root          36
  TYPE(MPI_Datatype), INTENT(IN) :: sendtype, recvttype      37
  TYPE(MPI_Comm), INTENT(IN) :: comm                         38
  TYPE(MPI_Request), INTENT(OUT) :: request                  39
  INTEGER, OPTIONAL, INTENT(OUT) :: ierror                   40
40 ticket-248T.
MPI_Igatherv(sendbuf, sendcount, sendtype, recvbuf, recvcounts, displs, 41
  recvttype, root, comm, request, ierror) BIND(C)             42
  TYPE(*), DIMENSION(..), INTENT(IN), ASYNCHRONOUS :: sendbuf 43
  TYPE(*), DIMENSION(..), ASYNCHRONOUS :: recvbuf            44
  INTEGER, INTENT(IN) :: sendcount, root                     45
  INTEGER, INTENT(IN), ASYNCHRONOUS :: recvcounts(*), displs(*) 46
  INTEGER, INTENT(IN), ASYNCHRONOUS :: recvcounts(*), displs(*) 47
47 ticket-248T.

```

```

1      TYPE(MPI_Datatype), INTENT(IN) :: sendtype, recvtype
2      TYPE(MPI_Comm), INTENT(IN) :: comm
3      TYPE(MPI_Request), INTENT(OUT) :: request
4      INTEGER, OPTIONAL, INTENT(OUT) :: ierror
ticket-248T. 5
6      MPI_Ireduce_scatter_block(sendbuf, recvbuf, recvcount, datatype, op, comm,
7          request, ierror) BIND(C)
8      TYPE(*), DIMENSION(..), INTENT(IN), ASYNCHRONOUS :: sendbuf
9      TYPE(*), DIMENSION(..), ASYNCHRONOUS :: recvbuf
10     INTEGER, INTENT(IN) :: recvcount
11     TYPE(MPI_Datatype), INTENT(IN) :: datatype
12     TYPE(MPI_Op), INTENT(IN) :: op
13     TYPE(MPI_Comm), INTENT(IN) :: comm
14     TYPE(MPI_Request), INTENT(OUT) :: request
15     INTEGER, OPTIONAL, INTENT(OUT) :: ierror
ticket-248T. 16
17     MPI_Ireduce_scatter(sendbuf, recvbuf, recvcounts, datatype, op, comm,
18         request, ierror) BIND(C)
19     TYPE(*), DIMENSION(..), INTENT(IN), ASYNCHRONOUS :: sendbuf
20     TYPE(*), DIMENSION(..), ASYNCHRONOUS :: recvbuf
21     INTEGER, INTENT(IN), ASYNCHRONOUS :: recvcounts(*)
22     TYPE(MPI_Datatype), INTENT(IN) :: datatype
23     TYPE(MPI_Op), INTENT(IN) :: op
24     TYPE(MPI_Comm), INTENT(IN) :: comm
25     TYPE(MPI_Request), INTENT(OUT) :: request
26     INTEGER, OPTIONAL, INTENT(OUT) :: ierror
ticket-248T. 27
28     MPI_Ireduce(sendbuf, recvbuf, count, datatype, op, root, comm, request,
29         ierror) BIND(C)
30     TYPE(*), DIMENSION(..), INTENT(IN), ASYNCHRONOUS :: sendbuf
31     TYPE(*), DIMENSION(..), ASYNCHRONOUS :: recvbuf
32     INTEGER, INTENT(IN) :: count, root
33     TYPE(MPI_Datatype), INTENT(IN) :: datatype
34     TYPE(MPI_Op), INTENT(IN) :: op
35     TYPE(MPI_Comm), INTENT(IN) :: comm
36     TYPE(MPI_Request), INTENT(OUT) :: request
37     INTEGER, OPTIONAL, INTENT(OUT) :: ierror
ticket-248T. 38
39     MPI_Iscan(sendbuf, recvbuf, count, datatype, op, comm, request, ierror)
40         BIND(C)
41     TYPE(*), DIMENSION(..), INTENT(IN), ASYNCHRONOUS :: sendbuf
42     TYPE(*), DIMENSION(..), ASYNCHRONOUS :: recvbuf
43     INTEGER, INTENT(IN) :: count
44     TYPE(MPI_Datatype), INTENT(IN) :: datatype
45     TYPE(MPI_Op), INTENT(IN) :: op
46     TYPE(MPI_Comm), INTENT(IN) :: comm
47     TYPE(MPI_Request), INTENT(OUT) :: request
48     INTEGER, OPTIONAL, INTENT(OUT) :: ierror
ticket-248T. 49
50     MPI_Iscatter(sendbuf, sendcount, sendtype, recvbuf, recvcount, recvtype,

```

```

        root, comm, request, ierror) BIND(C)
1
TYPE(*), DIMENSION(..), INTENT(IN), ASYNCHRONOUS :: sendbuf
2
TYPE(*), DIMENSION(..), ASYNCHRONOUS :: recvbuf
3
INTEGER, INTENT(IN) :: sendcount, recvcount, root
4
TYPE(MPI_Datatype), INTENT(IN) :: sendtype, recvtype
5
TYPE(MPI_Comm), INTENT(IN) :: comm
6
TYPE(MPI_Request), INTENT(OUT) :: request
7
INTEGER, OPTIONAL, INTENT(OUT) :: ierror
8
9 ticket-248T.
MPI_Iscatterv(sendbuf, sendcounts, displs, sendtype, recvbuf, recvcount,
10
        recvtype, root, comm, request, ierror) BIND(C)
11
TYPE(*), DIMENSION(..), INTENT(IN), ASYNCHRONOUS :: sendbuf
12
TYPE(*), DIMENSION(..), ASYNCHRONOUS :: recvbuf
13
INTEGER, INTENT(IN), ASYNCHRONOUS :: sendcounts(*), displs(*)
14
INTEGER, INTENT(IN) :: recvcount, root
15
TYPE(MPI_Datatype), INTENT(IN) :: sendtype, recvtype
16
TYPE(MPI_Comm), INTENT(IN) :: comm
17
TYPE(MPI_Request), INTENT(OUT) :: request
18
INTEGER, OPTIONAL, INTENT(OUT) :: ierror
19
20 ticket-248T.
MPI_Op_commutative(op, commute, ierror) BIND(C)
21
TYPE(MPI_Op), INTENT(IN) :: op
22
LOGICAL, INTENT(OUT) :: commute
23
INTEGER, OPTIONAL, INTENT(OUT) :: ierror
24
25 ticket-248T.
MPI_Op_create(user_fn, commute, op, ierror) BIND(C)
26
PROCEDURE(MPI_User_function) :: user_fn
27
LOGICAL, INTENT(IN) :: commute
28
TYPE(MPI_Op), INTENT(OUT) :: op
29
INTEGER, OPTIONAL, INTENT(OUT) :: ierror
30
31 ticket-248T.
MPI_Op_free(op, ierror) BIND(C)
32
TYPE(MPI_Op), INTENT(INOUT) :: op
33
INTEGER, OPTIONAL, INTENT(OUT) :: ierror
34
35 ticket-248T.
MPI_Reduce_local(inbuf, inoutbuf, count, datatype, op, ierror) BIND(C)
36
TYPE(*), DIMENSION(..), INTENT(IN) :: inbuf
37
TYPE(*), DIMENSION(..) :: inoutbuf
38
INTEGER, INTENT(IN) :: count
39
TYPE(MPI_Datatype), INTENT(IN) :: datatype
40
TYPE(MPI_Op), INTENT(IN) :: op
41
INTEGER, OPTIONAL, INTENT(OUT) :: ierror
42
43 ticket-248T.
MPI_Reduce_scatter_block(sendbuf, recvbuf, recvcount, datatype, op, comm,
44
        ierror) BIND(C)
45
TYPE(*), DIMENSION(..), INTENT(IN) :: sendbuf
46
TYPE(*), DIMENSION(..) :: recvbuf
47
INTEGER, INTENT(IN) :: recvcount
48
TYPE(MPI_Datatype), INTENT(IN) :: datatype
49
TYPE(MPI_Op), INTENT(IN) :: op
50

```

```

1      TYPE(MPI_Comm), INTENT(IN) :: comm
2      INTEGER, OPTIONAL, INTENT(OUT) :: ierror
ticket-248T. 3
4      MPI_Reduce_scatter(sendbuf, recvbuf, recvcounts, datatype, op, comm,
5                  ierror) BIND(C)
6      TYPE(*), DIMENSION(..), INTENT(IN) :: sendbuf
7      TYPE(*), DIMENSION(..) :: recvbuf
8      INTEGER, INTENT(IN) :: recvcounts(*)
9      TYPE(MPI_Datatype), INTENT(IN) :: datatype
10     TYPE(MPI_Op), INTENT(IN) :: op
11     TYPE(MPI_Comm), INTENT(IN) :: comm
ticket-248T. 12
13     MPI_Reduce(sendbuf, recvbuf, count, datatype, op, root, comm, ierror)
14             BIND(C)
15     TYPE(*), DIMENSION(..), INTENT(IN) :: sendbuf
16     TYPE(*), DIMENSION(..) :: recvbuf
17     INTEGER, INTENT(IN) :: count, root
18     TYPE(MPI_Datatype), INTENT(IN) :: datatype
19     TYPE(MPI_Op), INTENT(IN) :: op
20     TYPE(MPI_Comm), INTENT(IN) :: comm
21     INTEGER, OPTIONAL, INTENT(OUT) :: ierror
ticket-248T. 22
23     MPI_Scan(sendbuf, recvbuf, count, datatype, op, comm, ierror) BIND(C)
24     TYPE(*), DIMENSION(..), INTENT(IN) :: sendbuf
25     TYPE(*), DIMENSION(..) :: recvbuf
26     INTEGER, INTENT(IN) :: count
27     TYPE(MPI_Datatype), INTENT(IN) :: datatype
28     TYPE(MPI_Op), INTENT(IN) :: op
29     TYPE(MPI_Comm), INTENT(IN) :: comm
ticket-248T. 30
31     MPI_Scatter(sendbuf, sendcount, sendtype, recvbuf, recvcount, recvtype,
32             root, comm, ierror) BIND(C)
33     TYPE(*), DIMENSION(..), INTENT(IN) :: sendbuf
34     TYPE(*), DIMENSION(..) :: recvbuf
35     INTEGER, INTENT(IN) :: sendcount, recvcount, root
36     TYPE(MPI_Datatype), INTENT(IN) :: sendtype, recvtype
37     TYPE(MPI_Comm), INTENT(IN) :: comm
38     INTEGER, OPTIONAL, INTENT(OUT) :: ierror
ticket-248T. 39
40     MPI_Scatterv(sendbuf, sendcounts, displs, sendtype, recvbuf, recvcount,
41             recvtype, root, comm, ierror) BIND(C)
42     TYPE(*), DIMENSION(..), INTENT(IN) :: sendbuf
43     TYPE(*), DIMENSION(..) :: recvbuf
44     INTEGER, INTENT(IN) :: sendcounts(*), displs(*), recvcount, root
45     TYPE(MPI_Datatype), INTENT(IN) :: sendtype, recvtype
46     TYPE(MPI_Comm), INTENT(IN) :: comm
47     INTEGER, OPTIONAL, INTENT(OUT) :: ierror
48

```

A.3.4 Groups, Contexts, Communicators, and Caching Fortran 2008 Bindings

```

1
2 ticket-248T.
3
4
5
6 ticket-248T.
7
8
9
10
11
12 ticket-248T.
13
14
15
16
17
18
19 ticket-248T.
20
21
22
23
24 ticket-248T.
25
26
27
28
29 ticket-248T.
30
31
32
33
34
35
36
37
38 ticket-248T.
39
40
41
42 ticket-248T.
43
44
45 ticket-248T.
46
47
48

```

MPI_Comm_compare(comm1, comm2, result, ierror) BIND(C)
TYPE(MPI_Comm), INTENT(IN) :: comm1, comm2
INTEGER, INTENT(OUT) :: result
INTEGER, OPTIONAL, INTENT(OUT) :: ierror

MPI_Comm_create(comm, group, newcomm, ierror) BIND(C)
TYPE(MPI_Comm), INTENT(IN) :: comm
TYPE(MPI_Group), INTENT(IN) :: group
TYPE(MPI_Comm), INTENT(OUT) :: newcomm
INTEGER, OPTIONAL, INTENT(OUT) :: ierror

MPI_Comm_create_keyval(comm_copy_attr_fn, comm_delete_attr_fn, comm_keyval, extra_state, ierror) BIND(C)
PROCEDURE(MPI_Comm_copy_attr_function) :: comm_copy_attr_fn
PROCEDURE(MPI_Comm_delete_attr_function) :: comm_delete_attr_fn
INTEGER, INTENT(OUT) :: comm_keyval
INTEGER(KIND=MPI_ADDRESS_KIND), INTENT(IN) :: extra_state
INTEGER, OPTIONAL, INTENT(OUT) :: ierror

MPI_Comm_delete_attr(comm, comm_keyval, ierror) BIND(C)
TYPE(MPI_Comm), INTENT(IN) :: comm
INTEGER, INTENT(IN) :: comm_keyval
INTEGER, OPTIONAL, INTENT(OUT) :: ierror

MPI_Comm_dup(comm, newcomm, ierror) BIND(C)
TYPE(MPI_Comm), INTENT(IN) :: comm
TYPE(MPI_Comm), INTENT(OUT) :: newcomm
INTEGER, OPTIONAL, INTENT(OUT) :: ierror

MPI_COMM_DUP_FN(oldcomm, comm_keyval, extra_state, attribute_val_in, attribute_val_out, flag, ierror) BIND(C)
TYPE(MPI_Comm), INTENT(IN) :: oldcomm
INTEGER, INTENT(IN) :: comm_keyval
INTEGER(KIND=MPI_ADDRESS_KIND), INTENT(IN) :: extra_state,
attribute_val_in
INTEGER(KIND=MPI_ADDRESS_KIND), INTENT(OUT) :: attribute_val_out
LOGICAL, INTENT(OUT) :: flag
INTEGER, INTENT(OUT) :: ierror

MPI_Comm_free(comm, ierror) BIND(C)
TYPE(MPI_Comm), INTENT(INOUT) :: comm
INTEGER, OPTIONAL, INTENT(OUT) :: ierror

MPI_Comm_free_keyval(comm_keyval, ierror) BIND(C)
INTEGER, INTENT(INOUT) :: comm_keyval
INTEGER, OPTIONAL, INTENT(OUT) :: ierror

MPI_Comm_get_attr(comm, comm_keyval, attribute_val, flag, ierror) BIND(C)
TYPE(MPI_Comm), INTENT(IN) :: comm
INTEGER, INTENT(IN) :: comm_keyval

```

1      INTEGER(KIND=MPI_ADDRESS_KIND), INTENT(OUT) :: attribute_val
2      LOGICAL, INTENT(OUT) :: flag
3      INTEGER, OPTIONAL, INTENT(OUT) :: ierror
ticket-248T. 4
5      MPI_Comm_get_name(comm, comm_name, resultlen, ierror) BIND(C)
6      TYPE(MPI_Comm), INTENT(IN) :: comm
7      CHARACTER(LEN=MPI_MAX_OBJECT_NAME), INTENT(OUT) :: comm_name
8      INTEGER, INTENT(OUT) :: resultlen
9      INTEGER, OPTIONAL, INTENT(OUT) :: ierror
ticket-248T. 10
11     MPI_Comm_group(comm, group, ierror) BIND(C)
12     TYPE(MPI_Comm), INTENT(IN) :: comm
13     TYPE(MPI_Group), INTENT(OUT) :: group
14     INTEGER, OPTIONAL, INTENT(OUT) :: ierror
ticket-248T. 15
16     MPI_COMM_NULL_COPY_FN(oldcomm, comm_keyval, extra_state, attribute_val_in,
17         attribute_val_out, flag, ierror) BIND(C)
18     TYPE(MPI_Comm), INTENT(IN) :: oldcomm
19     INTEGER, INTENT(IN) :: comm_keyval
20     INTEGER(KIND=MPI_ADDRESS_KIND), INTENT(IN) :: extra_state,
21     attribute_val_in
22     INTEGER(KIND=MPI_ADDRESS_KIND), INTENT(OUT) :: attribute_val_out
23     LOGICAL, INTENT(OUT) :: flag
24     INTEGER, INTENT(OUT) :: ierror
ticket-248T. 25
26     MPI_COMM_NULL_DELETE_FN(comm, comm_keyval, attribute_val, extra_state,
27         ierror) BIND(C)
28     TYPE(MPI_Comm), INTENT(IN) :: comm
29     INTEGER, INTENT(IN) :: comm_keyval
30     INTEGER(KIND=MPI_ADDRESS_KIND), INTENT(IN) :: attribute_val,
31     extra_state
32     INTEGER, INTENT(OUT) :: ierror
ticket-248T. 33
34     MPI_Comm_rank(comm, rank, ierror) BIND(C)
35     TYPE(MPI_Comm), INTENT(IN) :: comm
36     INTEGER, INTENT(OUT) :: rank
37     INTEGER, OPTIONAL, INTENT(OUT) :: ierror
ticket-248T. 38
39     MPI_Comm_remote_group(comm, group, ierror) BIND(C)
40     TYPE(MPI_Comm), INTENT(IN) :: comm
41     TYPE(MPI_Group), INTENT(OUT) :: group
42     INTEGER, OPTIONAL, INTENT(OUT) :: ierror
ticket-248T. 43
44     MPI_Comm_remote_size(comm, size, ierror) BIND(C)
45     TYPE(MPI_Comm), INTENT(IN) :: comm
46     INTEGER, INTENT(OUT) :: size
47     INTEGER, OPTIONAL, INTENT(OUT) :: ierror
ticket-248T. 48
49     MPI_Comm_set_attr(comm, comm_keyval, attribute_val, ierror) BIND(C)
50     TYPE(MPI_Comm), INTENT(IN) :: comm
51     INTEGER, INTENT(IN) :: comm_keyval

```

```

    INTEGER(KIND=MPI_ADDRESS_KIND), INTENT(IN) :: attribute_val
    INTEGER, OPTIONAL, INTENT(OUT) :: ierror
1
2
3 ticket-248T.
MPI_Comm_set_name(comm, comm_name, ierror) BIND(C)
4
5
6
7 ticket-248T.
    TYPE(MPI_Comm), INTENT(IN) :: comm
    CHARACTER(LEN=*), INTENT(IN) :: comm_name
    INTEGER, OPTIONAL, INTENT(OUT) :: ierror
8
9
10
11
12 ticket-248T.
MPI_Comm_size(comm, size, ierror) BIND(C)
    TYPE(MPI_Comm), INTENT(IN) :: comm
    INTEGER, INTENT(OUT) :: size
    INTEGER, OPTIONAL, INTENT(OUT) :: ierror
13
14
15
16
17 ticket-248T.
MPI_Comm_split(comm, color, key, newcomm, ierror) BIND(C)
    TYPE(MPI_Comm), INTENT(IN) :: comm
    INTEGER, INTENT(IN) :: color, key
    TYPE(MPI_Comm), INTENT(OUT) :: newcomm
    INTEGER, OPTIONAL, INTENT(OUT) :: ierror
18
19
20
21
22 ticket-248T.
MPI_Comm_test_inter(comm, flag, ierror) BIND(C)
    TYPE(MPI_Comm), INTENT(IN) :: comm
    LOGICAL, INTENT(OUT) :: flag
    INTEGER, OPTIONAL, INTENT(OUT) :: ierror
23
24
25
26 ticket-248T.
MPI_Group_compare(group1, group2, result, ierror) BIND(C)
    TYPE(MPI_Group), INTENT(IN) :: group1, group2
    INTEGER, INTENT(OUT) :: result
    INTEGER, OPTIONAL, INTENT(OUT) :: ierror
27
28
29
30
31 ticket-248T.
MPI_Group_difference(group1, group2, newgroup, ierror) BIND(C)
    TYPE(MPI_Group), INTENT(IN) :: group1, group2
    TYPE(MPI_Group), INTENT(OUT) :: newgroup
    INTEGER, OPTIONAL, INTENT(OUT) :: ierror
32
33
34
35
36 ticket-248T.
MPI_Group_excl(group, n, ranks, newgroup, ierror) BIND(C)
    TYPE(MPI_Group), INTENT(IN) :: group
    INTEGER, INTENT(IN) :: n, ranks(n)
    TYPE(MPI_Group), INTENT(OUT) :: newgroup
    INTEGER, OPTIONAL, INTENT(OUT) :: ierror
37
38
39
40 ticket-248T.
MPI_Group_free(group, ierror) BIND(C)
    TYPE(MPI_Group), INTENT(INOUT) :: group
    INTEGER, OPTIONAL, INTENT(OUT) :: ierror
41
42
43
44
45
46 ticket-248T.
MPI_Group_incl(group, n, ranks, newgroup, ierror) BIND(C)
    TYPE(MPI_Group), INTENT(IN) :: group
    INTEGER, INTENT(IN) :: n, ranks(n)
    TYPE(MPI_Group), INTENT(OUT) :: newgroup
    INTEGER, OPTIONAL, INTENT(OUT) :: ierror
47
48
49

```

```

1      TYPE(MPI_Group), INTENT(OUT) :: newgroup
2      INTEGER, OPTIONAL, INTENT(OUT) :: ierror
ticket-248T. 3
4      MPI_Group_range_excl(group, n, ranges, newgroup, ierror) BIND(C)
5      TYPE(MPI_Group), INTENT(IN) :: group
6      INTEGER, INTENT(IN) :: n, ranges(3,n)
7      TYPE(MPI_Group), INTENT(OUT) :: newgroup
8      INTEGER, OPTIONAL, INTENT(OUT) :: ierror
ticket-248T. 9
10     MPI_Group_range_incl(group, n, ranges, newgroup, ierror) BIND(C)
11     TYPE(MPI_Group), INTENT(IN) :: group
12     INTEGER, INTENT(IN) :: n, ranges(3,n)
13     TYPE(MPI_Group), INTENT(OUT) :: newgroup
14     INTEGER, OPTIONAL, INTENT(OUT) :: ierror
ticket-248T. 15
16     MPI_Group_rank(group, rank, ierror) BIND(C)
17     TYPE(MPI_Group), INTENT(IN) :: group
18     INTEGER, INTENT(OUT) :: rank
19     INTEGER, OPTIONAL, INTENT(OUT) :: ierror
ticket-248T. 20
21     MPI_Group_size(group, size, ierror) BIND(C)
22     TYPE(MPI_Group), INTENT(IN) :: group
23     INTEGER, INTENT(OUT) :: size
24     INTEGER, OPTIONAL, INTENT(OUT) :: ierror
ticket-248T. 25
26     MPI_Group_translate_ranks(group1, n, ranks1, group2, ranks2, ierror)
27     BIND(C)
28     TYPE(MPI_Group), INTENT(IN) :: group1, group2
29     INTEGER, INTENT(IN) :: n, ranks1(n)
30     INTEGER, INTENT(OUT) :: ranks2(n)
31     INTEGER, OPTIONAL, INTENT(OUT) :: ierror
ticket-248T. 32
33     MPI_Group_union(group1, group2, newgroup, ierror) BIND(C)
34     TYPE(MPI_Group), INTENT(IN) :: group1, group2
35     TYPE(MPI_Group), INTENT(OUT) :: newgroup
36     INTEGER, OPTIONAL, INTENT(OUT) :: ierror
ticket-248T. 37
38     MPI_Intercomm_create(local_comm, local_leader, peer_comm, remote_leader,
39     tag, newintercomm, ierror) BIND(C)
40     TYPE(MPI_Comm), INTENT(IN) :: local_comm, peer_comm
41     INTEGER, INTENT(IN) :: local_leader, remote_leader, tag
42     TYPE(MPI_Comm), INTENT(OUT) :: newintercomm
43     INTEGER, OPTIONAL, INTENT(OUT) :: ierror
ticket-248T. 44
45     MPI_Intercomm_merge(intercomm, high, newintracomm, ierror) BIND(C)
46     TYPE(MPI_Comm), INTENT(IN) :: intercomm
47     LOGICAL, INTENT(IN) :: high
48     TYPE(MPI_Comm), INTENT(OUT) :: newintracomm
49     INTEGER, OPTIONAL, INTENT(OUT) :: ierror
ticket-248T. 50
51     MPI_Type_create_keyval(type_copy_attr_fn, type_delete_attr_fn, type_keyval,
52     extra_state, ierror) BIND(C)

```

```

PROCEDURE(MPI_Type_copy_attr_function) :: type_copy_attr_fn      1
PROCEDURE(MPI_Type_delete_attr_function) :: type_delete_attr_fn  2
INTEGER, INTENT(OUT) :: type_keyval                             3
INTEGER(KIND=MPI_ADDRESS_KIND), INTENT(IN) :: extra_state      4
INTEGER, OPTIONAL, INTENT(OUT) :: ierror                       5
                                                                6 ticket-248T.
MPI_Type_delete_attr(datatype, type_keyval, ierror) BIND(C)    7
  TYPE(MPI_Datatype), INTENT(IN) :: datatype                   8
  INTEGER, INTENT(IN) :: type_keyval                          9
  INTEGER, OPTIONAL, INTENT(OUT) :: ierror                    10
                                                                10 ticket-248T.
MPI_Type_dup_fn(oldtype, type_keyval, extra_state, attribute_val_in,
                attribute_val_out, flag, ierror) BIND(C)      11
  TYPE(MPI_Datatype), INTENT(IN) :: oldtype                   12
  INTEGER, INTENT(IN) :: type_keyval                          13
  INTEGER(KIND=MPI_ADDRESS_KIND), INTENT(IN) :: extra_state,  14
  attribute_val_in                                           15
  INTEGER(KIND=MPI_ADDRESS_KIND), INTENT(OUT) :: attribute_val_out 16
  LOGICAL, INTENT(OUT) :: flag                                17
  INTEGER, INTENT(OUT) :: ierror                              18
                                                                19
                                                                20 ticket-248T.
MPI_Type_free_keyval(type_keyval, ierror) BIND(C)             21
  INTEGER, INTENT(INOUT) :: type_keyval                       22
  INTEGER, OPTIONAL, INTENT(OUT) :: ierror                     23
                                                                23 ticket-248T.
MPI_Type_get_attr(datatype, type_keyval, attribute_val, flag, ierror)
  BIND(C)                                                      24
  TYPE(MPI_Datatype), INTENT(IN) :: datatype                  25
  INTEGER, INTENT(IN) :: type_keyval                          26
  INTEGER(KIND=MPI_ADDRESS_KIND), INTENT(OUT) :: attribute_val 27
  LOGICAL, INTENT(OUT) :: flag                                28
  INTEGER, OPTIONAL, INTENT(OUT) :: ierror                    29
                                                                30
                                                                31 ticket-248T.
MPI_Type_get_name(datatype, type_name, resultlen, ierror) BIND(C)
  TYPE(MPI_Datatype), INTENT(IN) :: datatype                  32
  CHARACTER(LEN=MPI_MAX_OBJECT_NAME), INTENT(OUT) :: type_name 33
  INTEGER, INTENT(OUT) :: resultlen                            34
  INTEGER, OPTIONAL, INTENT(OUT) :: ierror                    35
                                                                36
                                                                36 ticket-248T.
MPI_Type_null_copy_fn(oldtype, type_keyval, extra_state, attribute_val_in,
                    attribute_val_out, flag, ierror) BIND(C)  37
  TYPE(MPI_Datatype), INTENT(IN) :: oldtype                   38
  INTEGER, INTENT(IN) :: type_keyval                          39
  INTEGER(KIND=MPI_ADDRESS_KIND), INTENT(IN) :: extra_state,  40
  attribute_val_in                                           41
  INTEGER(KIND=MPI_ADDRESS_KIND), INTENT(OUT) :: attribute_val_out 42
  LOGICAL, INTENT(OUT) :: flag                                43
  INTEGER, INTENT(OUT) :: ierror                              44
                                                                45
                                                                46 ticket-248T.
MPI_Type_null_delete_fn(datatype, type_keyval, attribute_val, extra_state,
                       ierror) BIND(C)                        47
                                                                48

```

```

1      TYPE(MPI_Datatype), INTENT(IN) :: datatype
2      INTEGER, INTENT(IN) :: type_keyval
3      INTEGER(KIND=MPI_ADDRESS_KIND), INTENT(IN) :: attribute_val,
4      extra_state
5      INTEGER, INTENT(OUT) :: ierror
ticket-248T. 6
7      MPI_Type_set_attr(datatype, type_keyval, attribute_val, ierror) BIND(C)
8      TYPE(MPI_Datatype), INTENT(IN) :: datatype
9      INTEGER, INTENT(IN) :: type_keyval
10     INTEGER(KIND=MPI_ADDRESS_KIND), INTENT(IN) :: attribute_val
ticket-248T. 11
12     MPI_Type_set_name(datatype, type_name, ierror) BIND(C)
13     TYPE(MPI_Datatype), INTENT(IN) :: datatype
14     CHARACTER(LEN=*), INTENT(IN) :: type_name
15     INTEGER, OPTIONAL, INTENT(OUT) :: ierror
ticket-248T. 16
17     MPI_Win_create_keyval(win_copy_attr_fn, win_delete_attr_fn, win_keyval,
18         extra_state, ierror) BIND(C)
19     PROCEDURE(MPI_Win_copy_attr_function) :: win_copy_attr_fn
20     PROCEDURE(MPI_Win_delete_attr_function) :: win_delete_attr_fn
21     INTEGER, INTENT(OUT) :: win_keyval
22     INTEGER(KIND=MPI_ADDRESS_KIND), INTENT(IN) :: extra_state
ticket-248T. 23
24     MPI_Win_delete_attr(win, win_keyval, ierror) BIND(C)
25     TYPE(MPI_Win), INTENT(IN) :: win
26     INTEGER, INTENT(IN) :: win_keyval
27     INTEGER, OPTIONAL, INTENT(OUT) :: ierror
ticket-248T. 28
29     MPI_WIN_DUP_FN(oldwin, win_keyval, extra_state, attribute_val_in,
30         attribute_val_out, flag, ierror) BIND(C)
31     INTEGER, INTENT(IN) :: oldwin, win_keyval
32     INTEGER(KIND=MPI_ADDRESS_KIND), INTENT(IN) :: extra_state,
33     attribute_val_in
34     INTEGER(KIND=MPI_ADDRESS_KIND), INTENT(OUT) :: attribute_val_out
35     LOGICAL, INTENT(OUT) :: flag
36     INTEGER, INTENT(OUT) :: ierror
ticket-248T. 37
38     MPI_Win_free_keyval(win_keyval, ierror) BIND(C)
39     INTEGER, INTENT(INOUT) :: win_keyval
40     INTEGER, OPTIONAL, INTENT(OUT) :: ierror
ticket-248T. 41
42     MPI_Win_get_attr(win, win_keyval, attribute_val, flag, ierror) BIND(C)
43     TYPE(MPI_Win), INTENT(IN) :: win
44     INTEGER, INTENT(IN) :: win_keyval
45     INTEGER(KIND=MPI_ADDRESS_KIND), INTENT(OUT) :: attribute_val
46     LOGICAL, INTENT(OUT) :: flag
47     INTEGER, OPTIONAL, INTENT(OUT) :: ierror
ticket-248T. 48
49     MPI_Win_get_name(win, win_name, resultlen, ierror) BIND(C)

```

```

TYPE(MPI_Win), INTENT(IN) :: win
CHARACTER(LEN=MPI_MAX_OBJECT_NAME), INTENT(OUT) :: win_name
INTEGER, INTENT(OUT) :: resultlen
INTEGER, OPTIONAL, INTENT(OUT) :: ierror
MPI_WIN_NULL_COPY_FN(oldwin, win_keyval, extra_state, attribute_val_in,
attribute_val_out, flag, ierror) BIND(C)
INTEGER, INTENT(IN) :: oldwin, win_keyval
INTEGER(KIND=MPI_ADDRESS_KIND), INTENT(IN) :: extra_state,
attribute_val_in
INTEGER(KIND=MPI_ADDRESS_KIND), INTENT(OUT) :: attribute_val_out
LOGICAL, INTENT(OUT) :: flag
INTEGER, INTENT(OUT) :: ierror
MPI_WIN_NULL_DELETE_FN(win, win_keyval, attribute_val, extra_state, ierror)
BIND(C)
TYPE(MPI_Win), INTENT(IN) :: win
INTEGER, INTENT(IN) :: win_keyval
INTEGER(KIND=MPI_ADDRESS_KIND), INTENT(IN) :: attribute_val,
extra_state
INTEGER, INTENT(OUT) :: ierror
MPI_Win_set_attr(win, win_keyval, attribute_val, ierror) BIND(C)
TYPE(MPI_Win), INTENT(IN) :: win
INTEGER, INTENT(IN) :: win_keyval
INTEGER(KIND=MPI_ADDRESS_KIND), INTENT(IN) :: attribute_val
INTEGER, OPTIONAL, INTENT(OUT) :: ierror
MPI_Win_set_name(win, win_name, ierror) BIND(C)
TYPE(MPI_Win), INTENT(IN) :: win
CHARACTER(LEN=*), INTENT(IN) :: win_name
INTEGER, OPTIONAL, INTENT(OUT) :: ierror

```

A.3.5 Process Topologies Fortran 2008 Bindings

```

MPI_Cart_coords(comm, rank, maxdims, coords, ierror) BIND(C)
TYPE(MPI_Comm), INTENT(IN) :: comm
INTEGER, INTENT(IN) :: rank, maxdims
INTEGER, INTENT(OUT) :: coords(maxdims)
INTEGER, OPTIONAL, INTENT(OUT) :: ierror
MPI_Cart_create(comm_old, ndims, dims, periods, reorder, comm_cart, ierror)
BIND(C)
TYPE(MPI_Comm), INTENT(IN) :: comm_old
INTEGER, INTENT(IN) :: ndims, dims(ndims)
LOGICAL, INTENT(IN) :: periods(ndims), reorder
TYPE(MPI_Comm), INTENT(OUT) :: comm_cart
INTEGER, OPTIONAL, INTENT(OUT) :: ierror
MPI_Cartdim_get(comm, ndims, ierror) BIND(C)

```

```

1      TYPE(MPI_Comm), INTENT(IN) :: comm
2      INTEGER, INTENT(OUT) :: ndims
3      INTEGER, OPTIONAL, INTENT(OUT) :: ierror
ticket-248T. 4
5      MPI_Cart_get(comm, maxdims, dims, periods, coords, ierror) BIND(C)
6      TYPE(MPI_Comm), INTENT(IN) :: comm
7      INTEGER, INTENT(IN) :: maxdims
8      INTEGER, INTENT(OUT) :: dims(maxdims), coords(maxdims)
9      LOGICAL, INTENT(OUT) :: periods(maxdims)
10     INTEGER, OPTIONAL, INTENT(OUT) :: ierror
ticket-248T. 11
12     MPI_Cart_map(comm, ndims, dims, periods, newrank, ierror) BIND(C)
13     TYPE(MPI_Comm), INTENT(IN) :: comm
14     INTEGER, INTENT(IN) :: ndims, dims(ndims)
15     LOGICAL, INTENT(IN) :: periods(ndims)
16     INTEGER, INTENT(OUT) :: newrank
17     INTEGER, OPTIONAL, INTENT(OUT) :: ierror
ticket-248T. 18
19     MPI_Cart_rank(comm, coords, rank, ierror) BIND(C)
20     TYPE(MPI_Comm), INTENT(IN) :: comm
21     INTEGER, INTENT(IN) :: coords(*)
22     INTEGER, INTENT(OUT) :: rank
23     INTEGER, OPTIONAL, INTENT(OUT) :: ierror
ticket-248T. 24
25     MPI_Cart_shift(comm, direction, disp, rank_source, rank_dest, ierror)
26     BIND(C)
27     TYPE(MPI_Comm), INTENT(IN) :: comm
28     INTEGER, INTENT(IN) :: direction, disp
29     INTEGER, INTENT(OUT) :: rank_source, rank_dest
30     INTEGER, OPTIONAL, INTENT(OUT) :: ierror
ticket-248T. 31
32     MPI_Cart_sub(comm, remain_dims, newcomm, ierror) BIND(C)
33     TYPE(MPI_Comm), INTENT(IN) :: comm
34     LOGICAL, INTENT(IN) :: remain_dims(*)
35     TYPE(MPI_Comm), INTENT(OUT) :: newcomm
36     INTEGER, OPTIONAL, INTENT(OUT) :: ierror
ticket-248T. 37
38     MPI_Dims_create(nnodes, ndims, dims, ierror) BIND(C)
39     INTEGER, INTENT(IN) :: nnodes, ndims
40     INTEGER, INTENT(INOUT) :: dims(ndims)
41     INTEGER, OPTIONAL, INTENT(OUT) :: ierror
ticket-248T. 42
43     MPI_Dist_graph_create_adjacent(comm_old, indegree, sources, sourceweights,
44     outdegree, destinations, destweights, info, reorder,
45     comm_dist_graph, ierror) BIND(C)
46     TYPE(MPI_Comm), INTENT(IN) :: comm_old
47     INTEGER, INTENT(IN) :: indegree, sources(indegree), outdegree,
48     destinations(outdegree)
49     INTEGER, INTENT(IN) :: sourceweights(*), destweights(*)
50     TYPE(MPI_Info), INTENT(IN) :: info
51     LOGICAL, INTENT(IN) :: reorder

```



```

TYPE(MPI_Comm), INTENT(OUT) :: comm_dist_graph
INTEGER, OPTIONAL, INTENT(OUT) :: ierror
MPI_Dist_graph_create(comm_old, n, sources, degrees, destinations, weights,
    info, reorder, comm_dist_graph, ierror) BIND(C)
TYPE(MPI_Comm), INTENT(IN) :: comm_old
INTEGER, INTENT(IN) :: n, sources(n), degrees(n), destinations(*)
INTEGER, INTENT(IN) :: weights(*)
TYPE(MPI_Info), INTENT(IN) :: info
LOGICAL, INTENT(IN) :: reorder
TYPE(MPI_Comm), INTENT(OUT) :: comm_dist_graph
INTEGER, OPTIONAL, INTENT(OUT) :: ierror
MPI_Dist_graph_neighbors(comm, maxindegree, sources, sourceweights,
    maxoutdegree, destinations, destweights, ierror) BIND(C)
TYPE(MPI_Comm), INTENT(IN) :: comm
INTEGER, INTENT(IN) :: maxindegree, maxoutdegree
INTEGER, INTENT(OUT) :: sources(maxindegree),
    destinations(maxoutdegree)
INTEGER :: sourceweights(*), destweights(*)
INTEGER, OPTIONAL, INTENT(OUT) :: ierror
MPI_Dist_graph_neighbors_count(comm, indegree, outdegree, weighted, ierror)
    BIND(C)
TYPE(MPI_Comm), INTENT(IN) :: comm
INTEGER, INTENT(OUT) :: indegree, outdegree
LOGICAL, INTENT(OUT) :: weighted
INTEGER, OPTIONAL, INTENT(OUT) :: ierror
MPI_Graph_create(comm_old, nnodes, index, edges, reorder, comm_graph,
    ierror) BIND(C)
TYPE(MPI_Comm), INTENT(IN) :: comm_old
INTEGER, INTENT(IN) :: nnodes, index(nnodes), edges(*)
LOGICAL, INTENT(IN) :: reorder
TYPE(MPI_Comm), INTENT(OUT) :: comm_graph
INTEGER, OPTIONAL, INTENT(OUT) :: ierror
MPI_Graphdims_get(comm, nnodes, nedges, ierror) BIND(C)
TYPE(MPI_Comm), INTENT(IN) :: comm
INTEGER, INTENT(OUT) :: nnodes, nedges
INTEGER, OPTIONAL, INTENT(OUT) :: ierror
MPI_Graph_get(comm, maxindex, maxedges, index, edges, ierror) BIND(C)
TYPE(MPI_Comm), INTENT(IN) :: comm
INTEGER, INTENT(IN) :: maxindex, maxedges
INTEGER, INTENT(OUT) :: index(maxindex), edges(maxedges)
INTEGER, OPTIONAL, INTENT(OUT) :: ierror
MPI_Graph_map(comm, nnodes, index, edges, newrank, ierror) BIND(C)
TYPE(MPI_Comm), INTENT(IN) :: comm
INTEGER, INTENT(IN) :: nnodes, index(nnodes), edges(*)

```

```

1      INTEGER, INTENT(OUT) :: newrank
2      INTEGER, OPTIONAL, INTENT(OUT) :: ierror
ticket-248T. 3
4      MPI_Graph_neighbors(comm, rank, maxneighbors, neighbors, ierror) BIND(C)
5      TYPE(MPI_Comm), INTENT(IN) :: comm
6      INTEGER, INTENT(IN) :: rank, maxneighbors
7      INTEGER, INTENT(OUT) :: neighbors(maxneighbors)
8      INTEGER, OPTIONAL, INTENT(OUT) :: ierror
ticket-248T. 9
10     MPI_Graph_neighbors_count(comm, rank, nneighbors, ierror) BIND(C)
11     TYPE(MPI_Comm), INTENT(IN) :: comm
12     INTEGER, INTENT(IN) :: rank
13     INTEGER, INTENT(OUT) :: nneighbors
14     INTEGER, OPTIONAL, INTENT(OUT) :: ierror
ticket-248T. 15
16     MPI_Inighbor_allgather(sendbuf, sendcount, sendtype, recvbuf, recvcount,
17     recvtype, comm, request, ierror) BIND(C)
18     TYPE(*), DIMENSION(..), INTENT(IN), ASYNCHRONOUS :: sendbuf
19     TYPE(*), DIMENSION(..), ASYNCHRONOUS :: recvbuf
20     INTEGER, INTENT(IN) :: sendcount, recvcount
21     TYPE(MPI_Datatype), INTENT(IN) :: sendtype, recvtype
22     TYPE(MPI_Comm), INTENT(IN) :: comm
23     TYPE(MPI_Request), INTENT(OUT) :: request
24     INTEGER, OPTIONAL, INTENT(OUT) :: ierror
ticket-248T. 25
26     MPI_Inighbor_allgatherv(sendbuf, sendcount, sendtype, recvbuf, recvcounts,
27     displs, recvtype, comm, request, ierror) BIND(C)
28     TYPE(*), DIMENSION(..), INTENT(IN), ASYNCHRONOUS :: sendbuf
29     TYPE(*), DIMENSION(..), ASYNCHRONOUS :: recvbuf
30     INTEGER, INTENT(IN) :: sendcount
31     INTEGER, INTENT(IN), ASYNCHRONOUS :: recvcounts(*), displs(*)
32     TYPE(MPI_Datatype), INTENT(IN) :: sendtype, recvtype
33     TYPE(MPI_Comm), INTENT(IN) :: comm
34     TYPE(MPI_Request), INTENT(OUT) :: request
35     INTEGER, OPTIONAL, INTENT(OUT) :: ierror
ticket-248T. 36
37     MPI_Inighbor_alltoall(sendbuf, sendcount, sendtype, recvbuf, recvcount,
38     recvtype, comm, request, ierror) BIND(C)
39     TYPE(*), DIMENSION(..), INTENT(IN), ASYNCHRONOUS :: sendbuf
40     TYPE(*), DIMENSION(..), ASYNCHRONOUS :: recvbuf
41     INTEGER, INTENT(IN) :: sendcount, recvcount
42     TYPE(MPI_Datatype), INTENT(IN) :: sendtype, recvtype
43     TYPE(MPI_Comm), INTENT(IN) :: comm
44     TYPE(MPI_Request), INTENT(OUT) :: request
45     INTEGER, OPTIONAL, INTENT(OUT) :: ierror
ticket-248T. 46
47     MPI_Inighbor_alltoallv(sendbuf, sendcounts, sdispls, sendtype, recvbuf,
48     recvcounts, rdispls, recvtype, comm, request, ierror) BIND(C)
49     TYPE(*), DIMENSION(..), INTENT(IN), ASYNCHRONOUS :: sendbuf
50     TYPE(*), DIMENSION(..), ASYNCHRONOUS :: recvbuf

```

```

INTEGER, INTENT(IN), ASYNCHRONOUS :: sendcounts(*), sdispls(*),
recvcounts(*), rdispls(*)
TYPE(MPI_Datatype), INTENT(IN) :: sendtype, recvtype
TYPE(MPI_Comm), INTENT(IN) :: comm
TYPE(MPI_Request), INTENT(OUT) :: request
INTEGER, OPTIONAL, INTENT(OUT) :: ierror
MPI_Ineighbor_alltoallw(sendbuf, sendcounts, sdispls, sendtypes, recvbuf,
      recvcounts, rdispls, recvtypes, comm, request, ierror) BIND(C)
TYPE(*), DIMENSION(..), INTENT(IN), ASYNCHRONOUS :: sendbuf
TYPE(*), DIMENSION(..), ASYNCHRONOUS :: recvbuf
INTEGER, INTENT(IN), ASYNCHRONOUS :: sendcounts(*), recvcounts(*)
INTEGER(KIND=MPI_ADDRESS_KIND), INTENT(IN), ASYNCHRONOUS ::
sdispls(*), rdispls(*)
TYPE(MPI_Datatype), INTENT(IN), ASYNCHRONOUS :: sendtypes(*),
recvtypes(*)
TYPE(MPI_Comm), INTENT(IN) :: comm
TYPE(MPI_Request), INTENT(OUT) :: request
INTEGER, OPTIONAL, INTENT(OUT) :: ierror
MPI_Neighbor_allgather(sendbuf, sendcount, sendtype, recvbuf, recvcount,
      recvtype, comm, ierror) BIND(C)
TYPE(*), DIMENSION(..), INTENT(IN) :: sendbuf
TYPE(*), DIMENSION(..) :: recvbuf
INTEGER, INTENT(IN) :: sendcount, recvcount
TYPE(MPI_Datatype), INTENT(IN) :: sendtype, recvtype
TYPE(MPI_Comm), INTENT(IN) :: comm
INTEGER, OPTIONAL, INTENT(OUT) :: ierror
MPI_Neighbor_allgatherv(sendbuf, sendcount, sendtype, recvbuf, recvcounts,
      displs, recvtype, comm, ierror) BIND(C)
TYPE(*), DIMENSION(..), INTENT(IN) :: sendbuf
TYPE(*), DIMENSION(..) :: recvbuf
INTEGER, INTENT(IN) :: sendcount, recvcounts(*), displs(*)
TYPE(MPI_Datatype), INTENT(IN) :: sendtype, recvtype
TYPE(MPI_Comm), INTENT(IN) :: comm
INTEGER, OPTIONAL, INTENT(OUT) :: ierror
MPI_Neighbor_alltoall(sendbuf, sendcount, sendtype, recvbuf, recvcount,
      recvtype, comm, ierror) BIND(C)
TYPE(*), DIMENSION(..), INTENT(IN) :: sendbuf
TYPE(*), DIMENSION(..) :: recvbuf
INTEGER, INTENT(IN) :: sendcount, recvcount
TYPE(MPI_Datatype), INTENT(IN) :: sendtype, recvtype
TYPE(MPI_Comm), INTENT(IN) :: comm
INTEGER, OPTIONAL, INTENT(OUT) :: ierror
MPI_Neighbor_alltoallv(sendbuf, sendcounts, sdispls, sendtype, recvbuf,
      recvcounts, rdispls, recvtype, comm, ierror) BIND(C)
TYPE(*), DIMENSION(..), INTENT(IN) :: sendbuf

```

```

1      TYPE(*), DIMENSION(..) :: recvbuf
2      INTEGER, INTENT(IN) :: sendcounts(*), sdispls(*), recvcoun(*),
3      rdispls(*)
4      TYPE(MPI_Datatype), INTENT(IN) :: sendtype, recvtype
5      TYPE(MPI_Comm), INTENT(IN) :: comm
6      INTEGER, OPTIONAL, INTENT(OUT) :: ierror
ticket-248T. 7
8      MPI_Neighbor_alltoallw(sendbuf, sendcounts, sdispls, sendtypes, recvbuf,
9      recvcoun(*), rdispls, recvtypes, comm, ierror) BIND(C)
10     TYPE(*), DIMENSION(..), INTENT(IN) :: sendbuf
11     TYPE(*), DIMENSION(..) :: recvbuf
12     INTEGER, INTENT(IN) :: sendcounts(*), recvcoun(*)
13     INTEGER(KIND=MPI_ADDRESS_KIND), INTENT(IN) :: sdispls(*), rdispls(*)
14     TYPE(MPI_Datatype), INTENT(IN) :: sendtypes(*), recvtypes(*)
15     TYPE(MPI_Comm), INTENT(IN) :: comm
16     INTEGER, OPTIONAL, INTENT(OUT) :: ierror
ticket-248T. 16
17     MPI_Topo_test(comm, status, ierror) BIND(C)
18     TYPE(MPI_Comm), INTENT(IN) :: comm
19     INTEGER, INTENT(OUT) :: status
20     INTEGER, OPTIONAL, INTENT(OUT) :: ierror
21
22
23     A.3.6 MPI Environmental Management Fortran 2008 Bindings
ticket-248T. 24
25     DOUBLE PRECISION MPI_Wtick() BIND(C)
ticket-248T. 25
26     DOUBLE PRECISION MPI_Wtime() BIND(C)
ticket-248T. 26
27     MPI_Abort(comm, errorcode, ierror) BIND(C)
28     TYPE(MPI_Comm), INTENT(IN) :: comm
29     INTEGER, INTENT(IN) :: errorcode
30     INTEGER, OPTIONAL, INTENT(OUT) :: ierror
ticket-248T. 31
32     MPI_Add_error_class(errorclass, ierror) BIND(C)
33     INTEGER, INTENT(OUT) :: errorclass
34     INTEGER, OPTIONAL, INTENT(OUT) :: ierror
ticket-248T. 35
36     MPI_Add_error_code(errorclass, errorcode, ierror) BIND(C)
37     INTEGER, INTENT(IN) :: errorclass
38     INTEGER, INTENT(OUT) :: errorcode
39     INTEGER, OPTIONAL, INTENT(OUT) :: ierror
ticket-248T. 39
40     MPI_Add_error_string(errorcode, string, ierror) BIND(C)
41     INTEGER, INTENT(IN) :: errorcode
42     CHARACTER(LEN=*), INTENT(IN) :: string
43     INTEGER, OPTIONAL, INTENT(OUT) :: ierror
ticket-248T. 44
45     MPI_Alloc_mem(size, info, baseptr, ierror) BIND(C)
46     USE, INTRINSIC :: ISO_C_BINDING, ONLY : C_PTR
47     INTEGER(KIND=MPI_ADDRESS_KIND), INTENT(IN) :: size
48     TYPE(MPI_Info), INTENT(IN) :: info

```

```

TYPE(C_PTR), INTENT(OUT) :: baseptr
INTEGER, OPTIONAL, INTENT(OUT) :: ierror
MPI_Comm_call_errhandler(comm, errorcode, ierror) BIND(C)
TYPE(MPI_Comm), INTENT(IN) :: comm
INTEGER, INTENT(IN) :: errorcode
INTEGER, OPTIONAL, INTENT(OUT) :: ierror
MPI_Comm_create_errhandler(comm_errhandler_fn, errhandler, ierror) BIND(C)
PROCEDURE(MPI_Comm_errhandler_function) :: comm_errhandler_fn
TYPE(MPI_Errhandler), INTENT(OUT) :: errhandler
INTEGER, OPTIONAL, INTENT(OUT) :: ierror
MPI_Comm_get_errhandler(comm, errhandler, ierror) BIND(C)
TYPE(MPI_Comm), INTENT(IN) :: comm
TYPE(MPI_Errhandler), INTENT(OUT) :: errhandler
INTEGER, OPTIONAL, INTENT(OUT) :: ierror
MPI_Comm_set_errhandler(comm, errhandler, ierror) BIND(C)
TYPE(MPI_Comm), INTENT(IN) :: comm
TYPE(MPI_Errhandler), INTENT(IN) :: errhandler
INTEGER, OPTIONAL, INTENT(OUT) :: ierror
MPI_Errhandler_free(errhandler, ierror) BIND(C)
TYPE(MPI_Errhandler), INTENT(INOUT) :: errhandler
INTEGER, OPTIONAL, INTENT(OUT) :: ierror
MPI_Error_class(errorcode, errorclass, ierror) BIND(C)
INTEGER, INTENT(IN) :: errorcode
INTEGER, INTENT(OUT) :: errorclass
INTEGER, OPTIONAL, INTENT(OUT) :: ierror
MPI_Error_string(errorcode, string, resultlen, ierror) BIND(C)
INTEGER, INTENT(IN) :: errorcode
CHARACTER(LEN=MPI_MAX_ERROR_STRING), INTENT(OUT) :: string
INTEGER, INTENT(OUT) :: resultlen
INTEGER, OPTIONAL, INTENT(OUT) :: ierror
MPI_File_call_errhandler(fh, errorcode, ierror) BIND(C)
TYPE(MPI_File), INTENT(IN) :: fh
INTEGER, INTENT(IN) :: errorcode
INTEGER, OPTIONAL, INTENT(OUT) :: ierror
MPI_File_create_errhandler(file_errhandler_fn, errhandler, ierror) BIND(C)
PROCEDURE(MPI_File_errhandler_function) :: file_errhandler_fn
TYPE(MPI_Errhandler), INTENT(OUT) :: errhandler
INTEGER, OPTIONAL, INTENT(OUT) :: ierror
MPI_File_get_errhandler(file, errhandler, ierror) BIND(C)
TYPE(MPI_File), INTENT(IN) :: file
TYPE(MPI_Errhandler), INTENT(OUT) :: errhandler
INTEGER, OPTIONAL, INTENT(OUT) :: ierror

```

```

1 MPI_File_set_errhandler(file, errhandler, ierror) BIND(C)
2     TYPE(MPI_File), INTENT(IN) :: file
3     TYPE(MPI_Errhandler), INTENT(IN) :: errhandler
4     INTEGER, OPTIONAL, INTENT(OUT) :: ierror
ticket-248T. 5
6 MPI_Finalized(flag, ierror) BIND(C)
7     LOGICAL, INTENT(OUT) :: flag
8     INTEGER, OPTIONAL, INTENT(OUT) :: ierror
ticket-248T. 8
9 MPI_Finalize(ierror) BIND(C)
10    INTEGER, OPTIONAL, INTENT(OUT) :: ierror
ticket-248T. 11
12 MPI_Free_mem(base, ierror) BIND(C)
13    TYPE(*), DIMENSION(..), INTENT(IN), ASYNCHRONOUS :: base
14    INTEGER, OPTIONAL, INTENT(OUT) :: ierror
ticket-248T. 14
15 MPI_Get_processor_name(name, resultlen, ierror) BIND(C)
16    CHARACTER(LEN=MPI_MAX_PROCESSOR_NAME), INTENT(OUT) :: name
17    INTEGER, INTENT(OUT) :: resultlen
18    INTEGER, OPTIONAL, INTENT(OUT) :: ierror
ticket-248T. 19
20 MPI_Get_version(version, subversion, ierror) BIND(C)
21    INTEGER, INTENT(OUT) :: version, subversion
22    INTEGER, OPTIONAL, INTENT(OUT) :: ierror
ticket-248T. 22
23 MPI_Initialized(flag, ierror) BIND(C)
24    LOGICAL, INTENT(OUT) :: flag
25    INTEGER, OPTIONAL, INTENT(OUT) :: ierror
ticket-248T. 26
27 MPI_Init(ierror) BIND(C)
28    INTEGER, OPTIONAL, INTENT(OUT) :: ierror
ticket-248T. 28
29 MPI_Win_call_errhandler(win, errorcode, ierror) BIND(C)
30    TYPE(MPI_Win), INTENT(IN) :: win
31    INTEGER, INTENT(IN) :: errorcode
32    INTEGER, OPTIONAL, INTENT(OUT) :: ierror
ticket-248T. 33
34 MPI_Win_create_errhandler(win_errhandler_fn, errhandler, ierror) BIND(C)
35    PROCEDURE(MPI_Win_errhandler_function) :: win_errhandler_fn
36    TYPE(MPI_Errhandler), INTENT(OUT) :: errhandler
37    INTEGER, OPTIONAL, INTENT(OUT) :: ierror
ticket-248T. 37
38 MPI_Win_get_errhandler(win, errhandler, ierror) BIND(C)
39    TYPE(MPI_Win), INTENT(IN) :: win
40    TYPE(MPI_Errhandler), INTENT(OUT) :: errhandler
41    INTEGER, OPTIONAL, INTENT(OUT) :: ierror
ticket-248T. 42
43 MPI_Win_set_errhandler(win, errhandler, ierror) BIND(C)
44    TYPE(MPI_Win), INTENT(IN) :: win
45    TYPE(MPI_Errhandler), INTENT(IN) :: errhandler
46    INTEGER, OPTIONAL, INTENT(OUT) :: ierror
47
48

```

A.3.7 The Info Object Fortran 2008 Bindings

```

1
2 ticket-248T.
3
4
5 ticket-248T.
6
7
8
9
10 ticket-248T.
11
12
13
14 ticket-248T.
15
16
17
18 ticket-248T.
19
20
21
22
23
24
25 ticket-248T.
26
27
28
29
30 ticket-248T.
31
32
33
34
35 ticket-248T.
36
37
38
39
40
41
42 ticket-248T.
43
44
45
46
47
48

```

MPI_Info_create(info, ierror) BIND(C)
TYPE(MPI_Info), INTENT(OUT) :: info
INTEGER, OPTIONAL, INTENT(OUT) :: ierror

MPI_Info_delete(info, key, ierror) BIND(C)
TYPE(MPI_Info), INTENT(IN) :: info
CHARACTER(LEN=*), INTENT(IN) :: key
INTEGER, OPTIONAL, INTENT(OUT) :: ierror

MPI_Info_dup(info, newinfo, ierror) BIND(C)
TYPE(MPI_Info), INTENT(IN) :: info
TYPE(MPI_Info), INTENT(OUT) :: newinfo
INTEGER, OPTIONAL, INTENT(OUT) :: ierror

MPI_Info_free(info, ierror) BIND(C)
TYPE(MPI_Info), INTENT(INOUT) :: info
INTEGER, OPTIONAL, INTENT(OUT) :: ierror

MPI_Info_get(info, key, valuelen, value, flag, ierror) BIND(C)
TYPE(MPI_Info), INTENT(IN) :: info
CHARACTER(LEN=*), INTENT(IN) :: key
INTEGER, INTENT(IN) :: valuelen
CHARACTER(LEN=valuelen), INTENT(OUT) :: value
LOGICAL, INTENT(OUT) :: flag
INTEGER, OPTIONAL, INTENT(OUT) :: ierror

MPI_Info_get_nkeys(info, nkeys, ierror) BIND(C)
TYPE(MPI_Info), INTENT(IN) :: info
INTEGER, INTENT(OUT) :: nkeys
INTEGER, OPTIONAL, INTENT(OUT) :: ierror

MPI_Info_get_nthkey(info, n, key, ierror) BIND(C)
TYPE(MPI_Info), INTENT(IN) :: info
INTEGER, INTENT(IN) :: n
CHARACTER(LEN=*), INTENT(OUT) :: key
INTEGER, OPTIONAL, INTENT(OUT) :: ierror

MPI_Info_get_valuelen(info, key, valuelen, flag, ierror) BIND(C)
TYPE(MPI_Info), INTENT(IN) :: info
CHARACTER(LEN=*), INTENT(IN) :: key
INTEGER, INTENT(OUT) :: valuelen
LOGICAL, INTENT(OUT) :: flag
INTEGER, OPTIONAL, INTENT(OUT) :: ierror

MPI_Info_set(info, key, value, ierror) BIND(C)
TYPE(MPI_Info), INTENT(IN) :: info
CHARACTER(LEN=*), INTENT(IN) :: key, value
INTEGER, OPTIONAL, INTENT(OUT) :: ierror

A.3.8 Process Creation and Management Fortran 2008 Bindings

```

1
ticket-248T. 2
3 MPI_Close_port(port_name, ierror) BIND(C)
4   CHARACTER(LEN=*), INTENT(IN) :: port_name
5   INTEGER, OPTIONAL, INTENT(OUT) :: ierror
ticket-248T. 6
7 MPI_Comm_accept(port_name, info, root, comm, newcomm, ierror) BIND(C)
8   CHARACTER(LEN=*), INTENT(IN) :: port_name
9   TYPE(MPI_Info), INTENT(IN) :: info
10  INTEGER, INTENT(IN) :: root
11  TYPE(MPI_Comm), INTENT(IN) :: comm
12  TYPE(MPI_Comm), INTENT(OUT) :: newcomm
ticket-248T. 13
14 MPI_Comm_connect(port_name, info, root, comm, newcomm, ierror) BIND(C)
15  CHARACTER(LEN=*), INTENT(IN) :: port_name
16  TYPE(MPI_Info), INTENT(IN) :: info
17  INTEGER, INTENT(IN) :: root
18  TYPE(MPI_Comm), INTENT(IN) :: comm
19  TYPE(MPI_Comm), INTENT(OUT) :: newcomm
ticket-248T. 20
21 MPI_Comm_disconnect(comm, ierror) BIND(C)
22  TYPE(MPI_Comm), INTENT(INOUT) :: comm
23  INTEGER, OPTIONAL, INTENT(OUT) :: ierror
ticket-248T. 24
25 MPI_Comm_get_parent(parent, ierror) BIND(C)
26  TYPE(MPI_Comm), INTENT(OUT) :: parent
27  INTEGER, OPTIONAL, INTENT(OUT) :: ierror
ticket-248T. 28
29 MPI_Comm_join(fd, intercomm, ierror) BIND(C)
30  INTEGER, INTENT(IN) :: fd
31  TYPE(MPI_Comm), INTENT(OUT) :: intercomm
32  INTEGER, OPTIONAL, INTENT(OUT) :: ierror
ticket-248T. 33
34 MPI_Comm_spawn(command, argv, maxprocs, info, root, comm, intercomm,
35   array_of_errcodes, ierror) BIND(C)
36  CHARACTER(LEN=*), INTENT(IN) :: command, argv(*)
37  INTEGER, INTENT(IN) :: maxprocs, root
38  TYPE(MPI_Info), INTENT(IN) :: info
39  TYPE(MPI_Comm), INTENT(IN) :: comm
40  TYPE(MPI_Comm), INTENT(OUT) :: intercomm
41  INTEGER :: array_of_errcodes(*)
42  INTEGER, OPTIONAL, INTENT(OUT) :: ierror
ticket-248T. 43
44 MPI_Comm_spawn_multiple(count, array_of_commands, array_of_argv,
45   array_of_maxprocs, array_of_info, root, comm, intercomm,
46   array_of_errcodes, ierror) BIND(C)
47  INTEGER, INTENT(IN) :: count, array_of_maxprocs(*), root
48  CHARACTER(LEN=*), INTENT(IN) :: array_of_commands(*),
49   array_of_argv(count, *)

```



```

TYPE(MPI_Info), INTENT(IN) :: array_of_info(*)
TYPE(MPI_Comm), INTENT(IN) :: comm
TYPE(MPI_Comm), INTENT(OUT) :: intercomm
INTEGER :: array_of_errcodes(*)
INTEGER, OPTIONAL, INTENT(OUT) :: ierror
MPI_Lookup_name(service_name, info, port_name, ierror) BIND(C)
CHARACTER(LEN=*), INTENT(IN) :: service_name
TYPE(MPI_Info), INTENT(IN) :: info
CHARACTER(LEN=MPI_MAX_PORT_NAME), INTENT(OUT) :: port_name
INTEGER, OPTIONAL, INTENT(OUT) :: ierror
MPI_Open_port(info, port_name, ierror) BIND(C)
TYPE(MPI_Info), INTENT(IN) :: info
CHARACTER(LEN=MPI_MAX_PORT_NAME), INTENT(OUT) :: port_name
INTEGER, OPTIONAL, INTENT(OUT) :: ierror
MPI_Publish_name(service_name, info, port_name, ierror) BIND(C)
TYPE(MPI_Info), INTENT(IN) :: info
CHARACTER(LEN=*), INTENT(IN) :: service_name, port_name
INTEGER, OPTIONAL, INTENT(OUT) :: ierror
MPI_Unpublish_name(service_name, info, port_name, ierror) BIND(C)
CHARACTER(LEN=*), INTENT(IN) :: service_name, port_name
TYPE(MPI_Info), INTENT(IN) :: info
INTEGER, OPTIONAL, INTENT(OUT) :: ierror

```

A.3.9 One-Sided Communications Fortran 2008 Bindings

```

MPI_Accumulate(origin_addr, origin_count, origin_datatype, target_rank,
               target_disp, target_count, target_datatype, op, win, ierror)
               BIND(C)
TYPE(*), DIMENSION(..), INTENT(IN), ASYNCHRONOUS :: origin_addr
INTEGER, INTENT(IN) :: origin_count, target_rank, target_count
TYPE(MPI_Datatype), INTENT(IN) :: origin_datatype, target_datatype
INTEGER(KIND=MPI_ADDRESS_KIND), INTENT(IN) :: target_disp
TYPE(MPI_Op), INTENT(IN) :: op
TYPE(MPI_Win), INTENT(IN) :: win
INTEGER, OPTIONAL, INTENT(OUT) :: ierror
MPI_Compare_and_swap(origin_addr, compare_addr, result_addr, datatype,
                    target_rank, target_disp, win, ierror) BIND(C)
TYPE(*), DIMENSION(..), INTENT(IN), ASYNCHRONOUS :: origin_addr,
compare_addr
TYPE(*), DIMENSION(..), ASYNCHRONOUS :: result_addr
TYPE(MPI_Datatype), INTENT(IN) :: datatype
INTEGER, INTENT(IN) :: target_rank
INTEGER(KIND=MPI_ADDRESS_KIND), INTENT(IN) :: target_disp
TYPE(MPI_Win), INTENT(IN) :: win
INTEGER, OPTIONAL, INTENT(OUT) :: ierror

```

```

1
ticket-248T. 2 MPI_Fetch_and_op(origin_addr, result_addr, datatype, target_rank,
3             target_disp, op, win, ierror) BIND(C)
4             TYPE(*), DIMENSION(..), INTENT(IN), ASYNCHRONOUS :: origin_addr
5             TYPE(*), DIMENSION(..), ASYNCHRONOUS :: result_addr
6             TYPE(MPI_Datatype), INTENT(IN) :: datatype
7             INTEGER, INTENT(IN) :: target_rank
8             INTEGER(KIND=MPI_ADDRESS_KIND), INTENT(IN) :: target_disp
9             TYPE(MPI_Op), INTENT(IN) :: op
10            TYPE(MPI_Win), INTENT(IN) :: win
11            INTEGER, OPTIONAL, INTENT(OUT) :: ierror
ticket-248T. 12
13 MPI_Get_accumulate(origin_addr, origin_count, origin_datatype, result_addr,
14                 result_count, result_datatype, target_rank, target_disp,
15                 target_count, target_datatype, op, win, ierror) BIND(C)
16                 TYPE(*), DIMENSION(..), INTENT(IN), ASYNCHRONOUS :: origin_addr
17                 TYPE(*), DIMENSION(..), ASYNCHRONOUS :: result_addr
18                 INTEGER, INTENT(IN) :: origin_count, result_count, target_rank,
19                 target_count
20                 TYPE(MPI_Datatype), INTENT(IN) :: origin_datatype, target_datatype,
21                 result_datatype
22                 INTEGER(KIND=MPI_ADDRESS_KIND), INTENT(IN) :: target_disp
23                 TYPE(MPI_Op), INTENT(IN) :: op
24                 TYPE(MPI_Win), INTENT(IN) :: win
25                 INTEGER, OPTIONAL, INTENT(OUT) :: ierror
ticket-248T. 26 MPI_Get(origin_addr, origin_count, origin_datatype, target_rank,
27             target_disp, target_count, target_datatype, win, ierror)
28             BIND(C)
29             TYPE(*), DIMENSION(..), ASYNCHRONOUS :: origin_addr
30             INTEGER, INTENT(IN) :: origin_count, target_rank, target_count
31             TYPE(MPI_Datatype), INTENT(IN) :: origin_datatype, target_datatype
32             INTEGER(KIND=MPI_ADDRESS_KIND), INTENT(IN) :: target_disp
33             TYPE(MPI_Win), INTENT(IN) :: win
34             INTEGER, OPTIONAL, INTENT(OUT) :: ierror
ticket-248T. 35
36 MPI_Put(origin_addr, origin_count, origin_datatype, target_rank,
37         target_disp, target_count, target_datatype, win, ierror)
38         BIND(C)
39         TYPE(*), DIMENSION(..), INTENT(IN), ASYNCHRONOUS :: origin_addr
40         INTEGER, INTENT(IN) :: origin_count, target_rank, target_count
41         TYPE(MPI_Datatype), INTENT(IN) :: origin_datatype, target_datatype
42         INTEGER(KIND=MPI_ADDRESS_KIND), INTENT(IN) :: target_disp
43         TYPE(MPI_Win), INTENT(IN) :: win
44         INTEGER, OPTIONAL, INTENT(OUT) :: ierror
ticket-248T. 45 MPI_Raccumulate(origin_addr, origin_count, origin_datatype, target_rank,
46                 target_disp, target_count, target_datatype, op, win, request,
47                 ierror) BIND(C)
48                 TYPE(*), DIMENSION(..), INTENT(IN), ASYNCHRONOUS :: origin_addr

```

```

INTEGER, INTENT(IN) :: origin_count, target_rank, target_count      1
TYPE(MPI_Datatype), INTENT(IN) :: origin_datatype, target_datatype  2
INTEGER(KIND=MPI_ADDRESS_KIND), INTENT(IN) :: target_disp          3
TYPE(MPI_Op), INTENT(IN) :: op                                     4
TYPE(MPI_Win), INTENT(IN) :: win                                   5
TYPE(MPI_Request), INTENT(OUT) :: request                          6
INTEGER, OPTIONAL, INTENT(OUT) :: ierror                           7
                                                                    8 ticket-248T.
MPI_Rget_accumulate(origin_addr, origin_count, origin_datatype,
                    result_addr, result_count, result_datatype, target_rank,
                    target_disp, target_count, target_datatype, op, win, request,
                    ierror) BIND(C)                                9
                                                                    10
TYPE(*), DIMENSION(..), INTENT(IN), ASYNCHRONOUS :: origin_addr   11
TYPE(*), DIMENSION(..), ASYNCHRONOUS :: result_addr               12
INTEGER, INTENT(IN) :: origin_count, result_count, target_rank,   13
target_count                                                        14
TYPE(MPI_Datatype), INTENT(IN) :: origin_datatype, target_datatype, 15
result_datatype                                                    16
INTEGER(KIND=MPI_ADDRESS_KIND), INTENT(IN) :: target_disp        17
TYPE(MPI_Op), INTENT(IN) :: op                                     18
TYPE(MPI_Win), INTENT(IN) :: win                                   19
TYPE(MPI_Request), INTENT(OUT) :: request                          20
INTEGER, OPTIONAL, INTENT(OUT) :: ierror                           21
                                                                    22
MPI_Rget(origin_addr, origin_count, origin_datatype, target_rank, 23
          target_disp, target_count, target_datatype, win, request, 24
          ierror) BIND(C)                                          25
                                                                    26
TYPE(*), DIMENSION(..), ASYNCHRONOUS :: origin_addr              27
INTEGER, INTENT(IN) :: origin_count, target_rank, target_count    28
TYPE(MPI_Datatype), INTENT(IN) :: origin_datatype, target_datatype 29
INTEGER(KIND=MPI_ADDRESS_KIND), INTENT(IN) :: target_disp        30
TYPE(MPI_Win), INTENT(IN) :: win                                   31
TYPE(MPI_Request), INTENT(OUT) :: request                          32
INTEGER, OPTIONAL, INTENT(OUT) :: ierror                           33
                                                                    34 ticket-248T.
MPI_Rput(origin_addr, origin_count, origin_datatype, target_rank, 35
          target_disp, target_count, target_datatype, win, request, 36
          ierror) BIND(C)                                          37
                                                                    38
TYPE(*), DIMENSION(..), INTENT(IN), ASYNCHRONOUS :: origin_addr   39
INTEGER, INTENT(IN) :: origin_count, target_rank, target_count    40
TYPE(MPI_Datatype), INTENT(IN) :: origin_datatype, target_datatype 41
INTEGER(KIND=MPI_ADDRESS_KIND), INTENT(IN) :: target_disp        42
TYPE(MPI_Win), INTENT(IN) :: win                                   43
TYPE(MPI_Request), INTENT(OUT) :: request                          44
INTEGER, OPTIONAL, INTENT(OUT) :: ierror                           45
                                                                    46
MPI_Win_allocate_shared(size, info, comm, baseptr, win, ierror) BIND(C) 47
USE, INTRINSIC :: ISO_C_BINDING, ONLY : C_PTR                     48
INTEGER(KIND=MPI_Address_kind), INTENT(IN) :: size                49
                                                                    50

```

```

1      TYPE(MPI_Info), INTENT(IN) :: info
2      TYPE(MPI_Comm), INTENT(IN) :: comm
3      TYPE(C_PTR), INTENT(OUT) :: baseptr
4      TYPE(MPI_Win), INTENT(OUT) :: win
5      INTEGER, OPTIONAL, INTENT(OUT) :: ierror
ticket-248T. 6
7      MPI_Win_allocate(size, disp_unit, info, comm, baseptr, win, ierror) BIND(C)
8      USE, INTRINSIC :: ISO_C_BINDING, ONLY : C_PTR
9      INTEGER(KIND=MPI_ADDRESS_KIND), INTENT(IN) :: size
10     INTEGER, INTENT(IN) :: disp_unit
11     TYPE(MPI_Info), INTENT(IN) :: info
12     TYPE(MPI_Comm), INTENT(IN) :: comm
13     TYPE(C_PTR), INTENT(OUT) :: baseptr
14     TYPE(MPI_Win), INTENT(OUT) :: win
15     INTEGER, OPTIONAL, INTENT(OUT) :: ierror
ticket-248T. 16
17     MPI_Win_attach(win, base, size, ierror) BIND(C)
18     TYPE(MPI_Win), INTENT(IN) :: win
19     TYPE(*), ASYNCHRONOUS :: base
20     INTEGER(KIND=MPI_ADDRESS_KIND), INTENT(IN) :: size
21     INTEGER, OPTIONAL, INTENT(OUT) :: ierror
ticket-248T. 22
23     MPI_Win_complete(win, ierror) BIND(C)
24     TYPE(MPI_Win), INTENT(IN) :: win
25     INTEGER, OPTIONAL, INTENT(OUT) :: ierror
ticket-248T. 26
27     MPI_Win_create(base, size, disp_unit, info, comm, win, ierror) BIND(C)
28     TYPE(*), DIMENSION(..), ASYNCHRONOUS :: base
29     INTEGER(KIND=MPI_ADDRESS_KIND), INTENT(IN) :: size
30     INTEGER, INTENT(IN) :: disp_unit
31     TYPE(MPI_Info), INTENT(IN) :: info
32     TYPE(MPI_Comm), INTENT(IN) :: comm
33     TYPE(MPI_Win), INTENT(OUT) :: win
34     INTEGER, OPTIONAL, INTENT(OUT) :: ierror
ticket-248T. 35
36     MPI_Win_create_dynamic(info, comm, win, ierror) BIND(C)
37     TYPE(MPI_Info), INTENT(IN) :: info
38     TYPE(MPI_Comm), INTENT(IN) :: comm
39     TYPE(MPI_Win), INTENT(OUT) :: win
40     INTEGER, OPTIONAL, INTENT(OUT) :: ierror
ticket-248T. 41
42     MPI_Win_detach(win, base, ierror) BIND(C)
43     TYPE(MPI_Win), INTENT(IN) :: win
44     TYPE(*), ASYNCHRONOUS :: base
45     INTEGER, OPTIONAL, INTENT(OUT) :: ierror
ticket-248T. 46
47     MPI_Win_fence(assert, win, ierror) BIND(C)
48     INTEGER, INTENT(IN) :: assert
49     TYPE(MPI_Win), INTENT(IN) :: win
50     INTEGER, OPTIONAL, INTENT(OUT) :: ierror

```

```

MPI_Win_flush_all(win, ierror) BIND(C)
  TYPE(MPI_Win), INTENT(IN) :: win
  INTEGER, OPTIONAL, INTENT(OUT) :: ierror
MPI_Win_flush_local_all(win, ierror) BIND(C)
  TYPE(MPI_Win), INTENT(IN) :: win
  INTEGER, OPTIONAL, INTENT(OUT) :: ierror
MPI_Win_flush_local(rank, win, ierror) BIND(C)
  INTEGER, INTENT(IN) :: rank
  TYPE(MPI_Win), INTENT(IN) :: win
  INTEGER, OPTIONAL, INTENT(OUT) :: ierror
MPI_Win_flush(rank, win, ierror) BIND(C)
  INTEGER, INTENT(IN) :: rank
  TYPE(MPI_Win), INTENT(IN) :: win
  INTEGER, OPTIONAL, INTENT(OUT) :: ierror
MPI_Win_free(win, ierror) BIND(C)
  TYPE(MPI_Win), INTENT(INOUT) :: win
  INTEGER, OPTIONAL, INTENT(OUT) :: ierror
MPI_Win_get_group(win, group, ierror) BIND(C)
  TYPE(MPI_Win), INTENT(IN) :: win
  TYPE(MPI_Group), INTENT(OUT) :: group
  INTEGER, OPTIONAL, INTENT(OUT) :: ierror
MPI_Win_lock_all(assert, win, ierror) BIND(C)
  INTEGER, INTENT(IN) :: assert
  TYPE(MPI_Win), INTENT(IN) :: win
  INTEGER, OPTIONAL, INTENT(OUT) :: ierror
MPI_Win_lock(lock_type, rank, assert, win, ierror) BIND(C)
  INTEGER, INTENT(IN) :: lock_type, rank, assert
  TYPE(MPI_Win), INTENT(IN) :: win
  INTEGER, OPTIONAL, INTENT(OUT) :: ierror
MPI_Win_post(group, assert, win, ierror) BIND(C)
  TYPE(MPI_Group), INTENT(IN) :: group
  INTEGER, INTENT(IN) :: assert
  TYPE(MPI_Win), INTENT(IN) :: win
  INTEGER, OPTIONAL, INTENT(OUT) :: ierror
MPI_Win_shared_query(win, rank, size, baseptr, ierror) BIND(C)
  USE, INTRINSIC :: ISO_C_BINDING, ONLY : C_PTR
  TYPE(MPI_Win), INTENT(IN) :: win
  INTEGER, INTENT(IN) :: rank
  INTEGER(KIND=MPI_Address_kind), INTENT(IN) :: size
  TYPE(C_PTR), INTENT(OUT) :: baseptr
  INTEGER, OPTIONAL, INTENT(OUT) :: ierror
MPI_Win_start(group, assert, win, ierror) BIND(C)

```

```

1      TYPE(MPI_Group), INTENT(IN) :: group
2      INTEGER, INTENT(IN) :: assert
3      TYPE(MPI_Win), INTENT(IN) :: win
4      INTEGER, OPTIONAL, INTENT(OUT) :: ierror
ticket-248T. 5
6      MPI_Win_sync(win, ierror) BIND(C)
7      TYPE(MPI_Win), INTENT(IN) :: win
8      INTEGER, OPTIONAL, INTENT(OUT) :: ierror
ticket-248T. 8
9      MPI_Win_test(win, flag, ierror) BIND(C)
10     TYPE(MPI_Win), INTENT(IN) :: win
11     LOGICAL, INTENT(OUT) :: flag
12     INTEGER, OPTIONAL, INTENT(OUT) :: ierror
ticket-248T. 13
14     MPI_Win_unlock_all(win, ierror) BIND(C)
15     TYPE(MPI_Win), INTENT(IN) :: win
16     INTEGER, OPTIONAL, INTENT(OUT) :: ierror
ticket-248T. 16
17     MPI_Win_unlock(rank, win, ierror) BIND(C)
18     INTEGER, INTENT(IN) :: rank
19     TYPE(MPI_Win), INTENT(IN) :: win
20     INTEGER, OPTIONAL, INTENT(OUT) :: ierror
ticket-248T. 21
22     MPI_Win_wait(win, ierror) BIND(C)
23     TYPE(MPI_Win), INTENT(IN) :: win
24     INTEGER, OPTIONAL, INTENT(OUT) :: ierror
25
26
ticket-248T. 27     A.3.10 External Interfaces Fortran 2008 Bindings
28     MPI_Grequest_complete(request, ierror) BIND(C)
29     TYPE(MPI_Request), INTENT(IN) :: request
30     INTEGER, OPTIONAL, INTENT(OUT) :: ierror
ticket-248T. 31
32     MPI_Grequest_start(query_fn, free_fn, cancel_fn, extra_state, request,
33                        ierror) BIND(C)
34     PROCEDURE(MPI_Grequest_query_function) :: query_fn
35     PROCEDURE(MPI_Grequest_free_function) :: free_fn
36     PROCEDURE(MPI_Grequest_cancel_function) :: cancel_fn
37     INTEGER(KIND=MPI_ADDRESS_KIND), INTENT(IN) :: extra_state
38     TYPE(MPI_Request), INTENT(OUT) :: request
39     INTEGER, OPTIONAL, INTENT(OUT) :: ierror
ticket-248T. 39
40     MPI_Init_thread(required, provided, ierror) BIND(C)
41     INTEGER, INTENT(IN) :: required
42     INTEGER, INTENT(OUT) :: provided
43     INTEGER, OPTIONAL, INTENT(OUT) :: ierror
ticket-248T. 44
45     MPI_Is_thread_main(flag, ierror) BIND(C)
46     LOGICAL, INTENT(OUT) :: flag
47     INTEGER, OPTIONAL, INTENT(OUT) :: ierror
ticket-248T. 47
48     MPI_Query_thread(provided, ierror) BIND(C)

```

```

    INTEGER, INTENT(OUT) :: provided
    INTEGER, OPTIONAL, INTENT(OUT) :: ierror
MPI_Status_set_cancelled(status, flag, ierror) BIND(C)
    TYPE(MPI_Status), INTENT(INOUT) :: status
    LOGICAL, INTENT(OUT) :: flag
    INTEGER, OPTIONAL, INTENT(OUT) :: ierror
MPI_Status_set_elements(status, datatype, count, ierror) BIND(C)
    TYPE(MPI_Status), INTENT(INOUT) :: status
    TYPE(MPI_Datatype), INTENT(IN) :: datatype
    INTEGER, INTENT(IN) :: count
    INTEGER, OPTIONAL, INTENT(OUT) :: ierror
MPI_Status_set_elements_x(status, datatype, count, ierror) BIND(C)
    TYPE(MPI_Status), INTENT(INOUT) :: status
    TYPE(MPI_Datatype), INTENT(IN) :: datatype
    INTEGER(KIND = MPI_COUNT_KIND), INTENT(IN) :: count
    INTEGER, OPTIONAL, INTENT(OUT) :: ierror

A.3.11 I/O Fortran 2008 Bindings
MPI_File_close(fh, ierror) BIND(C)
    TYPE(MPI_File), INTENT(INOUT) :: fh
    INTEGER, OPTIONAL, INTENT(OUT) :: ierror
MPI_File_delete(filename, info, ierror) BIND(C)
    CHARACTER(LEN=*), INTENT(IN) :: filename
    TYPE(MPI_Info), INTENT(IN) :: info
    INTEGER, OPTIONAL, INTENT(OUT) :: ierror
MPI_File_get_amode(fh, amode, ierror) BIND(C)
    TYPE(MPI_File), INTENT(IN) :: fh
    INTEGER, INTENT(OUT) :: amode
    INTEGER, OPTIONAL, INTENT(OUT) :: ierror
MPI_File_get_atomicity(fh, flag, ierror) BIND(C)
    TYPE(MPI_File), INTENT(IN) :: fh
    LOGICAL, INTENT(OUT) :: flag
    INTEGER, OPTIONAL, INTENT(OUT) :: ierror
MPI_File_get_byte_offset(fh, offset, disp, ierror) BIND(C)
    TYPE(MPI_File), INTENT(IN) :: fh
    INTEGER(KIND=MPI_OFFSET_KIND), INTENT(IN) :: offset
    INTEGER(KIND=MPI_OFFSET_KIND), INTENT(OUT) :: disp
    INTEGER, OPTIONAL, INTENT(OUT) :: ierror
MPI_File_get_group(fh, group, ierror) BIND(C)
    TYPE(MPI_File), INTENT(IN) :: fh
    TYPE(MPI_Group), INTENT(OUT) :: group
    INTEGER, OPTIONAL, INTENT(OUT) :: ierror

```

```

1
ticket-248T. 2 MPI_File_get_info(fh, info_used, ierror) BIND(C)
3     TYPE(MPI_File), INTENT(IN) :: fh
4     TYPE(MPI_Info), INTENT(OUT) :: info_used
5     INTEGER, OPTIONAL, INTENT(OUT) :: ierror
ticket-248T. 6
7 MPI_File_get_position(fh, offset, ierror) BIND(C)
8     TYPE(MPI_File), INTENT(IN) :: fh
9     INTEGER(KIND=MPI_OFFSET_KIND), INTENT(OUT) :: offset
10    INTEGER, OPTIONAL, INTENT(OUT) :: ierror
ticket-248T. 11
12 MPI_File_get_position_shared(fh, offset, ierror) BIND(C)
13     TYPE(MPI_File), INTENT(IN) :: fh
14     INTEGER(KIND=MPI_OFFSET_KIND), INTENT(OUT) :: offset
15    INTEGER, OPTIONAL, INTENT(OUT) :: ierror
ticket-248T. 16
17 MPI_File_get_size(fh, size, ierror) BIND(C)
18     TYPE(MPI_File), INTENT(IN) :: fh
19     INTEGER(KIND=MPI_OFFSET_KIND), INTENT(OUT) :: size
20    INTEGER, OPTIONAL, INTENT(OUT) :: ierror
ticket-248T. 21
22 MPI_File_get_type_extent(fh, datatype, extent, ierror) BIND(C)
23     TYPE(MPI_File), INTENT(IN) :: fh
24     TYPE(MPI_Datatype), INTENT(IN) :: datatype
25     INTEGER(KIND=MPI_ADDRESS_KIND), INTENT(OUT) :: extent
26    INTEGER, OPTIONAL, INTENT(OUT) :: ierror
ticket-248T. 27
28 MPI_File_get_view(fh, disp, etype, filetype, datarep, ierror) BIND(C)
29     TYPE(MPI_File), INTENT(IN) :: fh
30     INTEGER(KIND=MPI_OFFSET_KIND), INTENT(OUT) :: disp
31     TYPE(MPI_Datatype), INTENT(OUT) :: etype, filetype
32     CHARACTER(LEN=*), INTENT(OUT) :: datarep
33     INTEGER, OPTIONAL, INTENT(OUT) :: ierror
ticket-248T. 34
35 MPI_File_iread_at(fh, offset, buf, count, datatype, request, ierror)
36     BIND(C)
37     TYPE(MPI_File), INTENT(IN) :: fh
38     INTEGER(KIND=MPI_OFFSET_KIND), INTENT(IN) :: offset
39     TYPE(*), DIMENSION(..), ASYNCHRONOUS :: buf
40     INTEGER, INTENT(IN) :: count
41     TYPE(MPI_Datatype), INTENT(IN) :: datatype
42     TYPE(MPI_Request), INTENT(OUT) :: request
43     INTEGER, OPTIONAL, INTENT(OUT) :: ierror
ticket-248T. 44
45 MPI_File_iread(fh, buf, count, datatype, request, ierror) BIND(C)
46     TYPE(MPI_File), INTENT(IN) :: fh
47     TYPE(*), DIMENSION(..), ASYNCHRONOUS :: buf
48     INTEGER, INTENT(IN) :: count
49     TYPE(MPI_Datatype), INTENT(IN) :: datatype
50     TYPE(MPI_Request), INTENT(OUT) :: request
51     INTEGER, OPTIONAL, INTENT(OUT) :: ierror

```



```

1
2 MPI_File_iread_shared(fh, buf, count, datatype, request, ierror) BIND(C) ticket-248T.
3   TYPE(MPI_File), INTENT(IN) :: fh
4   TYPE(*), DIMENSION(..), ASYNCHRONOUS :: buf
5   INTEGER, INTENT(IN) :: count
6   TYPE(MPI_Datatype), INTENT(IN) :: datatype
7   TYPE(MPI_Request), INTENT(OUT) :: request
8   INTEGER, OPTIONAL, INTENT(OUT) :: ierror
9
10 MPI_File_iwrite_at(fh, offset, buf, count, datatype, request, ierror) ticket-248T.
11   BIND(C)
12   TYPE(MPI_File), INTENT(IN) :: fh
13   INTEGER(KIND=MPI_OFFSET_KIND), INTENT(IN) :: offset
14   TYPE(*), DIMENSION(..), INTENT(IN), ASYNCHRONOUS :: buf
15   INTEGER, INTENT(IN) :: count
16   TYPE(MPI_Datatype), INTENT(IN) :: datatype
17   TYPE(MPI_Request), INTENT(OUT) :: request
18   INTEGER, OPTIONAL, INTENT(OUT) :: ierror
19
20 MPI_File_iwrite(fh, buf, count, datatype, request, ierror) BIND(C) ticket-248T.
21   TYPE(MPI_File), INTENT(IN) :: fh
22   TYPE(*), DIMENSION(..), INTENT(IN), ASYNCHRONOUS :: buf
23   INTEGER, INTENT(IN) :: count
24   TYPE(MPI_Datatype), INTENT(IN) :: datatype
25   TYPE(MPI_Request), INTENT(OUT) :: request
26   INTEGER, OPTIONAL, INTENT(OUT) :: ierror
27
28 MPI_File_iwrite_shared(fh, buf, count, datatype, request, ierror) BIND(C) ticket-248T.
29   TYPE(MPI_File), INTENT(IN) :: fh
30   TYPE(*), DIMENSION(..), INTENT(IN), ASYNCHRONOUS :: buf
31   INTEGER, INTENT(IN) :: count
32   TYPE(MPI_Datatype), INTENT(IN) :: datatype
33   TYPE(MPI_Request), INTENT(OUT) :: request
34   INTEGER, OPTIONAL, INTENT(OUT) :: ierror
35
36 MPI_File_open(comm, filename, amode, info, fh, ierror) BIND(C) ticket-248T.
37   TYPE(MPI_Comm), INTENT(IN) :: comm
38   CHARACTER(LEN=*), INTENT(IN) :: filename
39   INTEGER, INTENT(IN) :: amode
40   TYPE(MPI_Info), INTENT(IN) :: info
41   TYPE(MPI_File), INTENT(OUT) :: fh
42   INTEGER, OPTIONAL, INTENT(OUT) :: ierror
43
44 MPI_File_preallocate(fh, size, ierror) BIND(C) ticket-248T.
45   TYPE(MPI_File), INTENT(IN) :: fh
46   INTEGER(KIND=MPI_OFFSET_KIND), INTENT(IN) :: size
47   INTEGER, OPTIONAL, INTENT(OUT) :: ierror
48
49 MPI_File_read_all_begin(fh, buf, count, datatype, ierror) BIND(C)
50   TYPE(MPI_File), INTENT(IN) :: fh

```

```

1      TYPE(*), DIMENSION(..), ASYNCHRONOUS :: buf
2      INTEGER, INTENT(IN) :: count
3      TYPE(MPI_Datatype), INTENT(IN) :: datatype
4      INTEGER, OPTIONAL, INTENT(OUT) :: ierror
ticket-248T. 5
6      MPI_File_read_all_end(fh, buf, status, ierror) BIND(C)
7      TYPE(MPI_File), INTENT(IN) :: fh
8      TYPE(*), DIMENSION(..), ASYNCHRONOUS :: buf
9      TYPE(MPI_Status) :: status
10     INTEGER, OPTIONAL, INTENT(OUT) :: ierror
ticket-248T. 11
12     MPI_File_read_all(fh, buf, count, datatype, status, ierror) BIND(C)
13     TYPE(MPI_File), INTENT(IN) :: fh
14     TYPE(*), DIMENSION(..) :: buf
15     INTEGER, INTENT(IN) :: count
16     TYPE(MPI_Datatype), INTENT(IN) :: datatype
17     TYPE(MPI_Status) :: status
18     INTEGER, OPTIONAL, INTENT(OUT) :: ierror
ticket-248T. 19
20     MPI_File_read_at_all_begin(fh, offset, buf, count, datatype, ierror)
21     BIND(C)
22     TYPE(MPI_File), INTENT(IN) :: fh
23     INTEGER(KIND=MPI_OFFSET_KIND), INTENT(IN) :: offset
24     TYPE(*), DIMENSION(..), ASYNCHRONOUS :: buf
25     INTEGER, INTENT(IN) :: count
26     TYPE(MPI_Datatype), INTENT(IN) :: datatype
27     INTEGER, OPTIONAL, INTENT(OUT) :: ierror
ticket-248T. 28
29     MPI_File_read_at_all_end(fh, buf, status, ierror) BIND(C)
30     TYPE(MPI_File), INTENT(IN) :: fh
31     TYPE(*), DIMENSION(..), ASYNCHRONOUS :: buf
32     TYPE(MPI_Status) :: status
33     INTEGER, OPTIONAL, INTENT(OUT) :: ierror
ticket-248T. 34
35     MPI_File_read_at_all(fh, offset, buf, count, datatype, status, ierror)
36     BIND(C)
37     TYPE(MPI_File), INTENT(IN) :: fh
38     INTEGER(KIND=MPI_OFFSET_KIND), INTENT(IN) :: offset
39     TYPE(*), DIMENSION(..) :: buf
40     INTEGER, INTENT(IN) :: count
41     TYPE(MPI_Datatype), INTENT(IN) :: datatype
42     TYPE(MPI_Status) :: status
43     INTEGER, OPTIONAL, INTENT(OUT) :: ierror
ticket-248T. 44
45     MPI_File_read_at(fh, offset, buf, count, datatype, status, ierror) BIND(C)
46     TYPE(MPI_File), INTENT(IN) :: fh
47     INTEGER(KIND=MPI_OFFSET_KIND), INTENT(IN) :: offset
48     TYPE(*), DIMENSION(..) :: buf
49     INTEGER, INTENT(IN) :: count
50     TYPE(MPI_Datatype), INTENT(IN) :: datatype

```

```

TYPE(MPI_Status) :: status
INTEGER, OPTIONAL, INTENT(OUT) :: ierror
MPI_File_read(fh, buf, count, datatype, status, ierror) BIND(C)
TYPE(MPI_File), INTENT(IN) :: fh
TYPE(*), DIMENSION(..) :: buf
INTEGER, INTENT(IN) :: count
TYPE(MPI_Datatype), INTENT(IN) :: datatype
TYPE(MPI_Status) :: status
INTEGER, OPTIONAL, INTENT(OUT) :: ierror
MPI_File_read_ordered_begin(fh, buf, count, datatype, ierror) BIND(C)
TYPE(MPI_File), INTENT(IN) :: fh
TYPE(*), DIMENSION(..), ASYNCHRONOUS :: buf
INTEGER, INTENT(IN) :: count
TYPE(MPI_Datatype), INTENT(IN) :: datatype
INTEGER, OPTIONAL, INTENT(OUT) :: ierror
MPI_File_read_ordered_end(fh, buf, status, ierror) BIND(C)
TYPE(MPI_File), INTENT(IN) :: fh
TYPE(*), DIMENSION(..), ASYNCHRONOUS :: buf
TYPE(MPI_Status) :: status
INTEGER, OPTIONAL, INTENT(OUT) :: ierror
MPI_File_read_ordered(fh, buf, count, datatype, status, ierror) BIND(C)
TYPE(MPI_File), INTENT(IN) :: fh
TYPE(*), DIMENSION(..) :: buf
INTEGER, INTENT(IN) :: count
TYPE(MPI_Datatype), INTENT(IN) :: datatype
TYPE(MPI_Status) :: status
INTEGER, OPTIONAL, INTENT(OUT) :: ierror
MPI_File_read_shared(fh, buf, count, datatype, status, ierror) BIND(C)
TYPE(MPI_File), INTENT(IN) :: fh
TYPE(*), DIMENSION(..) :: buf
INTEGER, INTENT(IN) :: count
TYPE(MPI_Datatype), INTENT(IN) :: datatype
TYPE(MPI_Status) :: status
INTEGER, OPTIONAL, INTENT(OUT) :: ierror
MPI_File_seek(fh, offset, whence, ierror) BIND(C)
TYPE(MPI_File), INTENT(IN) :: fh
INTEGER(KIND=MPI_OFFSET_KIND), INTENT(IN) :: offset
INTEGER, INTENT(IN) :: whence
INTEGER, OPTIONAL, INTENT(OUT) :: ierror
MPI_File_seek_shared(fh, offset, whence, ierror) BIND(C)
TYPE(MPI_File), INTENT(IN) :: fh
INTEGER(KIND=MPI_OFFSET_KIND), INTENT(IN) :: offset
INTEGER, INTENT(IN) :: whence
INTEGER, OPTIONAL, INTENT(OUT) :: ierror

```

```

1
ticket-248T. 2 MPI_File_set_atomicity(fh, flag, ierror) BIND(C)
3     TYPE(MPI_File), INTENT(IN) :: fh
4     LOGICAL, INTENT(IN) :: flag
5     INTEGER, OPTIONAL, INTENT(OUT) :: ierror
ticket-248T. 6
7 MPI_File_set_info(fh, info, ierror) BIND(C)
8     TYPE(MPI_File), INTENT(IN) :: fh
9     TYPE(MPI_Info), INTENT(IN) :: info
10    INTEGER, OPTIONAL, INTENT(OUT) :: ierror
ticket-248T. 11
12 MPI_File_set_size(fh, size, ierror) BIND(C)
13    TYPE(MPI_File), INTENT(IN) :: fh
14    INTEGER(KIND=MPI_OFFSET_KIND), INTENT(IN) :: size
15    INTEGER, OPTIONAL, INTENT(OUT) :: ierror
ticket-248T. 16
17 MPI_File_set_view(fh, disp, etype, filetype, datarep, info, ierror) BIND(C)
18    TYPE(MPI_File), INTENT(IN) :: fh
19    INTEGER(KIND=MPI_OFFSET_KIND), INTENT(IN) :: disp
20    TYPE(MPI_Datatype), INTENT(IN) :: etype, filetype
21    CHARACTER(LEN=*), INTENT(IN) :: datarep
22    TYPE(MPI_Info), INTENT(IN) :: info
23    INTEGER, OPTIONAL, INTENT(OUT) :: ierror
ticket-248T. 24
25 MPI_File_sync(fh, ierror) BIND(C)
26    TYPE(MPI_File), INTENT(IN) :: fh
27    INTEGER, OPTIONAL, INTENT(OUT) :: ierror
ticket-248T. 28
29 MPI_File_write_all_begin(fh, buf, count, datatype, ierror) BIND(C)
30    TYPE(MPI_File), INTENT(IN) :: fh
31    TYPE(*), DIMENSION(..), INTENT(IN), ASYNCHRONOUS :: buf
32    INTEGER, INTENT(IN) :: count
33    TYPE(MPI_Datatype), INTENT(IN) :: datatype
34    INTEGER, OPTIONAL, INTENT(OUT) :: ierror
ticket-248T. 35
36 MPI_File_write_all_end(fh, buf, status, ierror) BIND(C)
37    TYPE(MPI_File), INTENT(IN) :: fh
38    TYPE(*), DIMENSION(..), INTENT(IN), ASYNCHRONOUS :: buf
39    TYPE(MPI_Status) :: status
40    INTEGER, OPTIONAL, INTENT(OUT) :: ierror
ticket-248T. 41
42 MPI_File_write_all(fh, buf, count, datatype, status, ierror) BIND(C)
43    TYPE(MPI_File), INTENT(IN) :: fh
44    TYPE(*), DIMENSION(..), INTENT(IN) :: buf
45    INTEGER, INTENT(IN) :: count
46    TYPE(MPI_Datatype), INTENT(IN) :: datatype
47    TYPE(MPI_Status) :: status
48    INTEGER, OPTIONAL, INTENT(OUT) :: ierror
ticket-248T. 49
50 MPI_File_write_at_all_begin(fh, offset, buf, count, datatype, ierror)
51    BIND(C)
52

```

```

TYPE(MPI_File), INTENT(IN) :: fh
INTEGER(KIND=MPI_OFFSET_KIND), INTENT(IN) :: offset
TYPE(*), DIMENSION(..), INTENT(IN), ASYNCHRONOUS :: buf
INTEGER, INTENT(IN) :: count
TYPE(MPI_Datatype), INTENT(IN) :: datatype
INTEGER, OPTIONAL, INTENT(OUT) :: ierror
MPI_File_write_at_all_end(fh, buf, status, ierror) BIND(C)
TYPE(MPI_File), INTENT(IN) :: fh
TYPE(*), DIMENSION(..), INTENT(IN), ASYNCHRONOUS :: buf
TYPE(MPI_Status) :: status
INTEGER, OPTIONAL, INTENT(OUT) :: ierror
MPI_File_write_at_all(fh, offset, buf, count, datatype, status, ierror)
BIND(C)
TYPE(MPI_File), INTENT(IN) :: fh
INTEGER(KIND=MPI_OFFSET_KIND), INTENT(IN) :: offset
TYPE(*), DIMENSION(..), INTENT(IN) :: buf
INTEGER, INTENT(IN) :: count
TYPE(MPI_Datatype), INTENT(IN) :: datatype
TYPE(MPI_Status) :: status
INTEGER, OPTIONAL, INTENT(OUT) :: ierror
MPI_File_write_at(fh, offset, buf, count, datatype, status, ierror) BIND(C)
TYPE(MPI_File), INTENT(IN) :: fh
INTEGER(KIND=MPI_OFFSET_KIND), INTENT(IN) :: offset
TYPE(*), DIMENSION(..), INTENT(IN) :: buf
INTEGER, INTENT(IN) :: count
TYPE(MPI_Datatype), INTENT(IN) :: datatype
TYPE(MPI_Status) :: status
INTEGER, OPTIONAL, INTENT(OUT) :: ierror
MPI_File_write(fh, buf, count, datatype, status, ierror) BIND(C)
TYPE(MPI_File), INTENT(IN) :: fh
TYPE(*), DIMENSION(..), INTENT(IN) :: buf
INTEGER, INTENT(IN) :: count
TYPE(MPI_Datatype), INTENT(IN) :: datatype
TYPE(MPI_Status) :: status
INTEGER, OPTIONAL, INTENT(OUT) :: ierror
MPI_File_write_ordered_begin(fh, buf, count, datatype, ierror) BIND(C)
TYPE(MPI_File), INTENT(IN) :: fh
TYPE(*), DIMENSION(..), INTENT(IN), ASYNCHRONOUS :: buf
INTEGER, INTENT(IN) :: count
TYPE(MPI_Datatype), INTENT(IN) :: datatype
INTEGER, OPTIONAL, INTENT(OUT) :: ierror
MPI_File_write_ordered_end(fh, buf, status, ierror) BIND(C)
TYPE(MPI_File), INTENT(IN) :: fh
TYPE(*), DIMENSION(..), INTENT(IN), ASYNCHRONOUS :: buf

```

```

1      TYPE(MPI_Status) :: status
2      INTEGER, OPTIONAL, INTENT(OUT) :: ierror
ticket-248T. 3
4      MPI_File_write_ordered(fh, buf, count, datatype, status, ierror) BIND(C)
5      TYPE(MPI_File), INTENT(IN) :: fh
6      TYPE(*), DIMENSION(..), INTENT(IN) :: buf
7      INTEGER, INTENT(IN) :: count
8      TYPE(MPI_Datatype), INTENT(IN) :: datatype
9      TYPE(MPI_Status) :: status
10     INTEGER, OPTIONAL, INTENT(OUT) :: ierror
ticket-248T. 10
11     MPI_File_write_shared(fh, buf, count, datatype, status, ierror) BIND(C)
12     TYPE(MPI_File), INTENT(IN) :: fh
13     TYPE(*), DIMENSION(..), INTENT(IN) :: buf
14     INTEGER, INTENT(IN) :: count
15     TYPE(MPI_Datatype), INTENT(IN) :: datatype
16     TYPE(MPI_Status) :: status
17     INTEGER, OPTIONAL, INTENT(OUT) :: ierror
ticket-248T. 17
18     MPI_Register_datarep(datarep, read_conversion_fn, write_conversion_fn,
19         dtype_file_extent_fn, extra_state, ierror) BIND(C)
20         CHARACTER(LEN=*), INTENT(IN) :: datarep
21         PROCEDURE(MPI_Datarep_conversion_function) :: read_conversion_fn
22         PROCEDURE(MPI_Datarep_conversion_function) :: write_conversion_fn
23         PROCEDURE(MPI_Datarep_extent_function) :: dtype_file_extent_fn
24         INTEGER(KIND=MPI_ADDRESS_KIND), INTENT(IN) :: extra_state
25         INTEGER, OPTIONAL, INTENT(OUT) :: ierror
26
27
28
29     A.3.12 Language Bindings Fortran 2008 Bindings
ticket-248T. 29
30     MPI_F_sync_reg(buf) BIND(C)
31     TYPE(*), DIMENSION(..), ASYNCHRONOUS :: buf
ticket-248T. 31
32     MPI_Sizeof(x, size, ierror) BIND(C)
33     TYPE(*), DIMENSION(..) :: x
34     INTEGER, INTENT(OUT) :: size
35     INTEGER, OPTIONAL, INTENT(OUT) :: ierror
ticket-248T. 35
36     MPI_Status_f082f(f08_status, f_status, ierror) BIND(C)
37     TYPE(MPI_Status), INTENT(IN) :: f08_status
38     INTEGER, INTENT(OUT) :: f_status(MPI_STATUS_SIZE)
39     INTEGER, OPTIONAL, INTENT(OUT) :: ierror
ticket-248T. 39
40     MPI_Status_f2f08(f_status, f08_status, ierror) BIND(C)
41     INTEGER, INTENT(IN) :: f_status(MPI_STATUS_SIZE)
42     TYPE(MPI_Status), INTENT(OUT) :: f08_status
43     INTEGER, OPTIONAL, INTENT(OUT) :: ierror
ticket-248T. 43
44     MPI_Type_create_f90_complex(p, r, newtype, ierror) BIND(C)
45     INTEGER, INTENT(IN) :: p, r
46     TYPE(MPI_Datatype), INTENT(OUT) :: newtype
47
48

```

```

    INTEGER, OPTIONAL, INTENT(OUT) :: ierror
MPI_Type_create_f90_integer(r, newtype, ierror) BIND(C)
    INTEGER, INTENT(IN) :: r
    TYPE(MPI_Datatype), INTENT(OUT) :: newtype
    INTEGER, OPTIONAL, INTENT(OUT) :: ierror

MPI_Type_create_f90_real(p, r, newtype, ierror) BIND(C)
    INTEGER, INTENT(IN) :: p, r
    TYPE(MPI_Datatype), INTENT(OUT) :: newtype
    INTEGER, OPTIONAL, INTENT(OUT) :: ierror

MPI_Type_match_size(typeclass, size, datatype, ierror) BIND(C)
    INTEGER, INTENT(IN) :: typeclass, size
    TYPE(MPI_Datatype), INTENT(OUT) :: datatype
    INTEGER, OPTIONAL, INTENT(OUT) :: ierror

```

A.3.13 Profiling Interface Fortran 2008 Bindings

A.3.14 Deprecated Fortran 2008 Bindings

1
2 ticket-248T.
3
4
5
6 ticket-248T.
7
8
9
10
11 ticket-248T.
12
13
14
15
16
17
18
19
20
21
22
23
24
25
26
27
28
29
30
31
32
33
34
35
36
37
38
39
40
41
42
43
44
45
46
47
48

A.4 Fortran Bindings with mpif.h or the mpi Module

A.4.1 Point-to-Point Communication Fortran Bindings

MPI_BSEND(BUF, COUNT, DATATYPE, DEST, TAG, COMM, IERROR)

<type> BUF(*)

INTEGER COUNT, DATATYPE, DEST, TAG, COMM, IERROR

MPI_BSEND_INIT(BUF, COUNT, DATATYPE, DEST, TAG, COMM, REQUEST, IERROR)

<type> BUF(*)

INTEGER [REQUEST,]COUNT, DATATYPE, DEST, TAG, COMM, REQUEST, IERROR

MPI_BUFFER_ATTACH(BUFFER, SIZE, IERROR)

<type> BUFFER(*)

INTEGER SIZE, IERROR

MPI_BUFFER_DETACH(BUFFER_ADDR, SIZE, IERROR)

<type> BUFFER_ADDR(*)

INTEGER SIZE, IERROR

MPI_CANCEL(REQUEST, IERROR)

INTEGER REQUEST, IERROR

MPI_GET_COUNT(STATUS, DATATYPE, COUNT, IERROR)

INTEGER STATUS(MPI_STATUS_SIZE), DATATYPE, COUNT, IERROR

MPI_IBSEND(BUF, COUNT, DATATYPE, DEST, TAG, COMM, REQUEST, IERROR)

<type> BUF(*)

INTEGER COUNT, DATATYPE, DEST, TAG, COMM, REQUEST, IERROR

MPI_IMPROBE(SOURCE, TAG, COMM, FLAG, MESSAGE, STATUS, IERROR)

INTEGER SOURCE, TAG, COMM, FLAG, MESSAGE, STATUS(MPI_STATUS_SIZE),

IERROR

MPI_IMRECV(BUF, COUNT, DATATYPE, MESSAGE, REQUEST, IERROR)

<type> BUF(*)

INTEGER COUNT, DATATYPE, MESSAGE, REQUEST, IERROR

MPI_IPROBE(SOURCE, TAG, COMM, FLAG, STATUS, IERROR)

LOGICAL FLAG

INTEGER SOURCE, TAG, COMM, STATUS(MPI_STATUS_SIZE), IERROR

MPI_IRECV(BUF, COUNT, DATATYPE, SOURCE, TAG, COMM, REQUEST, IERROR)

<type> BUF(*)

INTEGER COUNT, DATATYPE, SOURCE, TAG, COMM, REQUEST, IERROR

MPI_IRSEND(BUF, COUNT, DATATYPE, DEST, TAG, COMM, REQUEST, IERROR)

<type> BUF(*)

INTEGER COUNT, DATATYPE, DEST, TAG, COMM, REQUEST, IERROR

MPI_ISEND(BUF, COUNT, DATATYPE, DEST, TAG, COMM, REQUEST, IERROR)

<type> BUF(*)

INTEGER COUNT, DATATYPE, DEST, TAG, COMM, REQUEST, IERROR

MPI_ISSEND(BUF, COUNT, DATATYPE, DEST, TAG, COMM, REQUEST, IERROR)	1
<type> BUF(*)	2
INTEGER COUNT, DATATYPE, DEST, TAG, COMM, REQUEST, IERROR	3
MPI_MPROBE(SOURCE, TAG, COMM, MESSAGE, STATUS, IERROR)	4
INTEGER SOURCE, TAG, COMM, MESSAGE, STATUS(MPI_STATUS_SIZE), IERROR	5
MPI_MRECV(BUF, COUNT, DATATYPE, MESSAGE, STATUS, IERROR)	6
<type> BUF(*)	7
INTEGER COUNT, DATATYPE, MESSAGE, STATUS(MPI_STATUS_SIZE), IERROR	8
MPI_PROBE(SOURCE, TAG, COMM, STATUS, IERROR)	9
INTEGER SOURCE, TAG, COMM, STATUS(MPI_STATUS_SIZE), IERROR	10
MPI_RECV(BUF, COUNT, DATATYPE, SOURCE, TAG, COMM, STATUS, IERROR)	11
<type> BUF(*)	12
INTEGER COUNT, DATATYPE, SOURCE, TAG, COMM, STATUS(MPI_STATUS_SIZE),	13
IERROR	14
MPI_RECV_INIT(BUF, COUNT, DATATYPE, SOURCE, TAG, COMM, REQUEST, IERROR)	15
<type> BUF(*)	16
INTEGER COUNT, DATATYPE, SOURCE, TAG, COMM, REQUEST, IERROR	17
MPI_REQUEST_FREE(REQUEST, IERROR)	18
INTEGER REQUEST, IERROR	19
MPI_REQUEST_GET_STATUS(REQUEST, FLAG, STATUS, IERROR)	20
INTEGER REQUEST, STATUS(MPI_STATUS_SIZE), IERROR	21
LOGICAL FLAG	22
MPI_RSEND(BUF, COUNT, DATATYPE, DEST, TAG, COMM, IERROR)	23
<type> BUF(*)	24
INTEGER COUNT, DATATYPE, DEST, TAG, COMM, IERROR	25
MPI_RSEND_INIT(BUF, COUNT, DATATYPE, DEST, TAG, COMM, REQUEST, IERROR)	26
<type> BUF(*)	27
INTEGER COUNT, DATATYPE, DEST, TAG, COMM, REQUEST, IERROR	28
MPI_SEND(BUF, COUNT, DATATYPE, DEST, TAG, COMM, IERROR)	29
<type> BUF(*)	30
INTEGER COUNT, DATATYPE, DEST, TAG, COMM, IERROR	31
MPI_SEND_INIT(BUF, COUNT, DATATYPE, DEST, TAG, COMM, REQUEST, IERROR)	32
<type> BUF(*)	33
INTEGER [REQUEST,]COUNT, DATATYPE, DEST, TAG, COMM, REQUEST, IERROR	34
MPI_SENDRECV_REPLACE(BUF, COUNT, DATATYPE, DEST, SENDTAG, SOURCE, RECVTAG,	35
COMM, STATUS, IERROR)	36
<type> BUF(*)	37
INTEGER COUNT, DATATYPE, DEST, SENDTAG, SOURCE, RECVTAG, COMM,	38
STATUS(MPI_STATUS_SIZE), IERROR	39
MPI_SENDRECV(SENDBUF, SENDCOUNT, SENDTYPE, DEST, SENDTAG, RECVBUF,	40
RECVCOUNT, RECVMODE, SOURCE, RECVTAG, COMM, STATUS, IERROR)	41
RECVCOUNT, RECVMODE, SOURCE, RECVTAG, COMM, STATUS, IERROR)	42
RECVCOUNT, RECVMODE, SOURCE, RECVTAG, COMM, STATUS, IERROR)	43
RECVCOUNT, RECVMODE, SOURCE, RECVTAG, COMM, STATUS, IERROR)	44
RECVCOUNT, RECVMODE, SOURCE, RECVTAG, COMM, STATUS, IERROR)	45
RECVCOUNT, RECVMODE, SOURCE, RECVTAG, COMM, STATUS, IERROR)	46
RECVCOUNT, RECVMODE, SOURCE, RECVTAG, COMM, STATUS, IERROR)	47
RECVCOUNT, RECVMODE, SOURCE, RECVTAG, COMM, STATUS, IERROR)	48

```

1     <type> SENDBUF(*), RECVBUF(*)
2     INTEGER SENDCOUNT, SENDTYPE, DEST, SENDTAG, RECVCOUNT, RECVMYPE,
3     SOURCE, RECMTAG, COMM, STATUS(MPI_STATUS_SIZE), IERROR
4
5 MPI_SSEND(BUF, COUNT, DATATYPE, DEST, TAG, COMM, IERROR)
6     <type> BUF(*)
7     INTEGER COUNT, DATATYPE, DEST, TAG, COMM, IERROR
8
9 MPI_SSEND_INIT(BUF, COUNT, DATATYPE, DEST, TAG, COMM, REQUEST, IERROR)
10    <type> BUF(*)
11    INTEGER COUNT, DATATYPE, DEST, TAG, COMM, REQUEST, IERROR
12
13 MPI_STARTALL(COUNT, ARRAY_OF_REQUESTS, IERROR)
14    INTEGER COUNT, ARRAY_OF_REQUESTS(*), IERROR
15
16 MPI_START(REQUEST, IERROR)
17    INTEGER REQUEST, IERROR
18
19 MPI_TESTALL(COUNT, ARRAY_OF_REQUESTS, FLAG, ARRAY_OF_STATUSES, IERROR)
20    LOGICAL FLAG
21    INTEGER COUNT, ARRAY_OF_REQUESTS(*),
22    ARRAY_OF_STATUSES(MPI_STATUS_SIZE,*), IERROR
23
24 MPI_TESTANY(COUNT, ARRAY_OF_REQUESTS, INDEX, FLAG, STATUS, IERROR)
25    LOGICAL FLAG
26    INTEGER COUNT, ARRAY_OF_REQUESTS(*), INDEX, STATUS(MPI_STATUS_SIZE),
27    IERROR
28
29 MPI_TEST_CANCELLED(STATUS, FLAG, IERROR)
30    LOGICAL FLAG
31    INTEGER STATUS(MPI_STATUS_SIZE), IERROR
32
33 MPI_TEST(REQUEST, FLAG, STATUS, IERROR)
34    LOGICAL FLAG
35    INTEGER REQUEST, STATUS(MPI_STATUS_SIZE), IERROR
36
37 MPI_TESTSOME(INCOUNT, ARRAY_OF_REQUESTS, OUTCOUNT, ARRAY_OF_INDICES,
38             ARRAY_OF_STATUSES, IERROR)
39    INTEGER INCOUNT, ARRAY_OF_REQUESTS(*), OUTCOUNT, ARRAY_OF_INDICES(*),
40    ARRAY_OF_STATUSES(MPI_STATUS_SIZE,*), IERROR
41
42 MPI_WAITALL(COUNT, ARRAY_OF_REQUESTS, ARRAY_OF_STATUSES, IERROR)
43    INTEGER COUNT, ARRAY_OF_REQUESTS(*)
44    INTEGER ARRAY_OF_STATUSES(MPI_STATUS_SIZE,*), IERROR
45
46 MPI_WAITANY(COUNT, ARRAY_OF_REQUESTS, INDEX, STATUS, IERROR)
47    INTEGER COUNT, ARRAY_OF_REQUESTS(*), INDEX, STATUS(MPI_STATUS_SIZE),
48    IERROR
49
50 MPI_WAIT(REQUEST, STATUS, IERROR)
51    INTEGER REQUEST, STATUS(MPI_STATUS_SIZE), IERROR
52
53 MPI_WAITSOME(INCOUNT, ARRAY_OF_REQUESTS, OUTCOUNT, ARRAY_OF_INDICES,
54             ARRAY_OF_STATUSES, IERROR)

```

```

INTEGER INCOUNT, ARRAY_OF_REQUESTS(*), OUTCOUNT, ARRAY_OF_INDICES(*),
ARRAY_OF_STATUSES(MPI_STATUS_SIZE,*), IERROR
1
2
3
4
A.4.2 Datatypes Fortran Bindings
5
MPI_GET_ADDRESS(LOCATION, ADDRESS, IERROR)
6
  <type> LOCATION(*)
7
  INTEGER IERROR
8
  INTEGER(KIND=MPI_ADDRESS_KIND) ADDRESS
9
10
MPI_GET_ELEMENTS(STATUS, DATATYPE, COUNT, IERROR)
11
  INTEGER STATUS(MPI_STATUS_SIZE), DATATYPE, COUNT, IERROR
12
13
MPI_GET_ELEMENTS_X(STATUS, DATATYPE, COUNT, IERROR)
14
  INTEGER STATUS(MPI_STATUS_SIZE), DATATYPE, IERROR
15
  INTEGER (KIND=MPI_COUNT_KIND) COUNT
16
MPI_PACK_EXTERNAL(DATAREP, INBUF, INCOUNT, DATATYPE, OUTBUF, OUTSIZE,
17
  POSITION, IERROR)
18
  INTEGER INCOUNT, DATATYPE, IERROR
19
  INTEGER(KIND=MPI_ADDRESS_KIND) OUTSIZE, POSITION
20
  CHARACTER*(*) DATAREP
21
  <type> INBUF(*), OUTBUF(*)
22
23
MPI_PACK_EXTERNAL_SIZE(DATAREP, INCOUNT, DATATYPE, SIZE, IERROR)
24
  INTEGER INCOUNT, DATATYPE, IERROR
25
  INTEGER(KIND=MPI_ADDRESS_KIND) SIZE
26
  CHARACTER*(*) DATAREP
27
MPI_PACK(INBUF, INCOUNT, DATATYPE, OUTBUF, OUTSIZE, POSITION, COMM, IERROR)
28
  <type> INBUF(*), OUTBUF(*)
29
  INTEGER INCOUNT, DATATYPE, OUTSIZE, POSITION, COMM, IERROR
30
31
MPI_PACK_SIZE(INCOUNT, DATATYPE, COMM, SIZE, IERROR)
32
  INTEGER INCOUNT, DATATYPE, COMM, SIZE, IERROR
33
MPI_TYPE_COMMIT(DATATYPE, IERROR)
34
  INTEGER DATATYPE, IERROR
35
36
MPI_TYPE_CONTIGUOUS(COUNT, OLDTYPE, NEWTYPE, IERROR)
37
  INTEGER COUNT, OLDTYPE, NEWTYPE, IERROR
38
MPI_TYPE_CREATE_DARRAY(SIZE, RANK, NDIMS, ARRAY_OF_GSIZES,
39
  ARRAY_OF_DISTRIBS, ARRAY_OF_DARGS, ARRAY_OF_PSIZEs, ORDER,
40
  OLDTYPE, NEWTYPE, IERROR)
41
  INTEGER SIZE, RANK, NDIMS, ARRAY_OF_GSIZES(*), ARRAY_OF_DISTRIBS(*),
42
  ARRAY_OF_DARGS(*), ARRAY_OF_PSIZEs(*), ORDER, OLDTYPE, NEWTYPE, IERROR
43
44
MPI_TYPE_CREATE_HINDEXED_BLOCK(COUNT, BLOCKLENGTH, ARRAY_OF_DISPLACEMENTS,
45
  OLDTYPE, NEWTYPE, IERROR)
46
  INTEGER COUNT, BLOCKLENGTH, OLDTYPE, NEWTYPE, IERROR
47
  INTEGER(KIND=MPI_ADDRESS_KIND) ARRAY_OF_DISPLACEMENTS(*)
48

```

```

1 MPI_TYPE_CREATE_HINDEXED(COUNT, ARRAY_OF_BLOCKLENGTHS,
2     ARRAY_OF_DISPLACEMENTS, OLDTYPE, NEWTYPE, IERROR)
3     INTEGER COUNT, ARRAY_OF_BLOCKLENGTHS(*), OLDTYPE, NEWTYPE, IERROR
4     INTEGER(KIND=MPI_ADDRESS_KIND) ARRAY_OF_DISPLACEMENTS(*)
5
6 MPI_TYPE_CREATE_HVECTOR(COUNT, BLOCKLENGTH, STRIDE, OLDTYPE, NEWTYPE,
7     IERROR)
8     INTEGER COUNT, BLOCKLENGTH, OLDTYPE, NEWTYPE, IERROR
9     INTEGER(KIND=MPI_ADDRESS_KIND) STRIDE
10
11 MPI_TYPE_CREATE_INDEXED_BLOCK(COUNT, BLOCKLENGTH, ARRAY_OF_DISPLACEMENTS,
12     OLDTYPE, NEWTYPE, IERROR)
13     INTEGER COUNT, BLOCKLENGTH, ARRAY_OF_DISPLACEMENTS(*), OLDTYPE,
14     NEWTYPE, IERROR
15
16 MPI_TYPE_CREATE_RESIZED(OLDTYPE, LB, EXTENT, NEWTYPE, IERROR)
17     INTEGER OLDTYPE, NEWTYPE, IERROR
18     INTEGER(KIND=MPI_ADDRESS_KIND) LB, EXTENT
19
20 MPI_TYPE_CREATE_STRUCT(COUNT, ARRAY_OF_BLOCKLENGTHS,
21     ARRAY_OF_DISPLACEMENTS, ARRAY_OF_TYPES, NEWTYPE, IERROR)
22     INTEGER COUNT, ARRAY_OF_BLOCKLENGTHS(*), ARRAY_OF_TYPES(*), NEWTYPE,
23     IERROR
24     INTEGER(KIND=MPI_ADDRESS_KIND) ARRAY_OF_DISPLACEMENTS(*)
25
26 MPI_TYPE_CREATE_SUBARRAY(NDIMS, ARRAY_OF_SIZES, ARRAY_OF_SUBSIZES,
27     ARRAY_OF_STARTS, ORDER, OLDTYPE, NEWTYPE, IERROR)
28     INTEGER NDIMS, ARRAY_OF_SIZES(*), ARRAY_OF_SUBSIZES(*),
29     ARRAY_OF_STARTS(*), ORDER, OLDTYPE, NEWTYPE, IERROR
30
31 MPI_TYPE_DUP(OLDTYPE, NEWTYPE, IERROR)
32     INTEGER OLDTYPE, NEWTYPE, IERROR
33
34 MPI_TYPE_FREE(DATATYPE, IERROR)
35     INTEGER DATATYPE, IERROR
36
37 MPI_TYPE_GET_CONTENTS(DATATYPE, MAX_INTEGERS, MAX_ADDRESSES, MAX_DATATYPES,
38     ARRAY_OF_INTEGERS, ARRAY_OF_ADDRESSES, ARRAY_OF_DATATYPES,
39     IERROR)
40     INTEGER DATATYPE, MAX_INTEGERS, MAX_ADDRESSES, MAX_DATATYPES,
41     ARRAY_OF_INTEGERS(*), ARRAY_OF_DATATYPES(*), IERROR
42     INTEGER(KIND=MPI_ADDRESS_KIND) ARRAY_OF_ADDRESSES(*)
43
44 MPI_TYPE_GET_ENVELOPE(DATATYPE, NUM_INTEGERS, NUM_ADDRESSES, NUM_DATATYPES,
45     COMBINER, IERROR)
46     INTEGER DATATYPE, NUM_INTEGERS, NUM_ADDRESSES, NUM_DATATYPES, COMBINER,
47     IERROR
48
49 MPI_TYPE_GET_EXTENT(DATATYPE, LB, EXTENT, IERROR)
50     INTEGER DATATYPE, IERROR
51     INTEGER(KIND = MPI_ADDRESS_KIND) LB, EXTENT
52
53 MPI_TYPE_GET_TRUE_EXTENT(DATATYPE, TRUE_LB, TRUE_EXTENT, IERROR)

```

ticket252-W.
ticket252-W.

```

INTEGER DATATYPE, IERROR 1
INTEGER(KIND = MPI_ADDRESS_KIND) TRUE_LB, TRUE_EXTENT 2
3
MPI_TYPE_INDEXED(COUNT, ARRAY_OF_BLOCKLENGTHS, ARRAY_OF_DISPLACEMENTS, 4
OLDTYPE, NEWTYPE, IERROR) 5
INTEGER COUNT, ARRAY_OF_BLOCKLENGTHS(*), ARRAY_OF_DISPLACEMENTS(*), 6
OLDTYPE, NEWTYPE, IERROR 7
MPI_TYPE_SIZE(DATATYPE, SIZE, IERROR) 8
INTEGER DATATYPE, SIZE, IERROR 9
10
MPI_TYPE_VECTOR(COUNT, BLOCKLENGTH, STRIDE, OLDTYPE, NEWTYPE, IERROR) 11
INTEGER COUNT, BLOCKLENGTH, STRIDE, OLDTYPE, NEWTYPE, IERROR 12
MPI_UNPACK_EXTERNAL(DATAREP, INBUF, INSIZE, POSITION, OUTBUF, OUTCOUNT, 13
DATATYPE, IERROR) 14
INTEGER OUTCOUNT, DATATYPE, IERROR 15
INTEGER(KIND=MPI_ADDRESS_KIND) INSIZE, POSITION 16
CHARACTER*(*) DATAREP 17
<type> INBUF(*), OUTBUF(*) 18
19
MPI_UNPACK(INBUF, INSIZE, POSITION, OUTBUF, OUTCOUNT, DATATYPE, COMM, 20
IERROR) 21
<type> INBUF(*), OUTBUF(*) 22
INTEGER INSIZE, POSITION, OUTCOUNT, DATATYPE, COMM, IERROR 23
24

```

A.4.3 Collective Communication Fortran Bindings

```

MPI_ALLGATHER(SENDBUF, SENDCOUNT, SENDTYPE, RECVBUFFER, RECVCOUNT, RECVTYPE, 27
COMM, IERROR) 28
<type> SENDBUF(*), RECVBUFFER(*) 29
INTEGER SENDCOUNT, SENDTYPE, RECVCOUNT, RECVTYPE, COMM, IERROR 30
MPI_ALLGATHERV(SENDBUF, SENDCOUNT, SENDTYPE, RECVBUFFER, RECVCOUNTS, DISPLS, 31
RECVTYPE, COMM, IERROR) 32
<type> SENDBUF(*), RECVBUFFER(*) 33
INTEGER SENDCOUNT, SENDTYPE, RECVCOUNTS(*), DISPLS(*), RECVTYPE, COMM, 34
IERROR 35
MPI_ALLREDUCE(SENDBUF, RECVBUFFER, COUNT, DATATYPE, OP, COMM, IERROR) 37
<type> SENDBUF(*), RECVBUFFER(*) 38
INTEGER COUNT, DATATYPE, OP, COMM, IERROR 39
MPI_ALLTOALL(SENDBUF, SENDCOUNT, SENDTYPE, RECVBUFFER, RECVCOUNT, RECVTYPE, 40
COMM, IERROR) 41
<type> SENDBUF(*), RECVBUFFER(*) 42
INTEGER SENDCOUNT, SENDTYPE, RECVCOUNT, RECVTYPE, COMM, IERROR 43
MPI_ALLTOALLV(SENDBUF, SENDCOUNTS, SDISPLS, SENDTYPE, RECVBUFFER, RECVCOUNTS, 45
RDISPLS, RECVTYPE, COMM, IERROR) 46
<type> SENDBUF(*), RECVBUFFER(*) 47
48

```

```

1     INTEGER SENDCOUNTS(*), SDISPLS(*), SENDTYPE, RECVCOUNTS(*), RDISPLS(*),
2     RECVTYPE, COMM, IERROR
3
4     MPI_ALLTOALLW(SENDBUF, SENDCOUNTS, SDISPLS, SENDTYPES, RECVBUF, RECVCOUNTS,
5     RDISPLS, RECVTYPES, COMM, IERROR)
6     <type> SENDBUF(*), RECVBUF(*)
7     INTEGER SENDCOUNTS(*), SDISPLS(*), SENDTYPES(*), RECVCOUNTS(*),
8     RDISPLS(*), RECVTYPES(*), COMM, IERROR
9
10    MPI_BARRIER(COMM, IERROR)
11    INTEGER COMM, IERROR
12
13    MPI_BCAST(BUFFER, COUNT, DATATYPE, ROOT, COMM, IERROR)
14    <type> BUFFER(*)
15    INTEGER COUNT, DATATYPE, ROOT, COMM, IERROR
16
17    MPI_EXSCAN(SENDBUF, RECVBUF, COUNT, DATATYPE, OP, COMM, IERROR)
18    <type> SENDBUF(*), RECVBUF(*)
19    INTEGER COUNT, DATATYPE, OP, COMM, IERROR
20
21    MPI_GATHER(SENDBUF, SENDCOUNT, SENDTYPE, RECVBUF, RECVCOUNT, RECVTYPE,
22    ROOT, COMM, IERROR)
23    <type> SENDBUF(*), RECVBUF(*)
24    INTEGER SENDCOUNT, SENDTYPE, RECVCOUNT, RECVTYPE, ROOT, COMM, IERROR
25
26    MPI_GATHERV(SENDBUF, SENDCOUNT, SENDTYPE, RECVBUF, RECVCOUNTS, DISPLS,
27    RECVTYPE, ROOT, COMM, IERROR)
28    <type> SENDBUF(*), RECVBUF(*)
29    INTEGER SENDCOUNT, SENDTYPE, RECVCOUNTS(*), DISPLS(*), RECVTYPE, ROOT,
30    COMM, IERROR
31
32    MPI_IALLGATHER(SENDBUF, SENDCOUNT, SENDTYPE, RECVBUF, RECVCOUNT, RECVTYPE,
33    COMM, REQUEST, IERROR)
34    <type> SENDBUF(*), RECVBUF(*)
35    INTEGER SENDCOUNT, SENDTYPE, RECVCOUNT, RECVTYPE, COMM, REQUEST, IERROR
36
37    MPI_IALLGATHERV(SENDBUF, SENDCOUNT, SENDTYPE, RECVBUF, RECVCOUNTS, DISPLS,
38    RECVTYPE, COMM, REQUEST, IERROR)
39    <type> SENDBUF(*), RECVBUF(*)
40    INTEGER SENDCOUNT, SENDTYPE, RECVCOUNTS(*), DISPLS(*), RECVTYPE, COMM,
41    REQUEST, IERROR
42
43    MPI_IALLREDUCE(SENDBUF, RECVBUF, COUNT, DATATYPE, OP, COMM, REQUEST,
44    IERROR)
45    <type> SENDBUF(*), RECVBUF(*)
46    INTEGER COUNT, DATATYPE, OP, COMM, REQUEST, IERROR
47
48    MPI_IALLTOALL(SENDBUF, SENDCOUNT, SENDTYPE, RECVBUF, RECVCOUNT, RECVTYPE,
49    COMM, REQUEST, IERROR)
50    <type> SENDBUF(*), RECVBUF(*)
51    INTEGER SENDCOUNT, SENDTYPE, RECVCOUNT, RECVTYPE, COMM, REQUEST, IERROR
52
53    MPI_IALLTOALLV(SENDBUF, SENDCOUNTS, SDISPLS, SENDTYPE, RECVBUF, RECVCOUNTS,
54    RDISPLS, RECVTYPES, COMM, IERROR)
55    <type> SENDBUF(*), RECVBUF(*)
56    INTEGER SENDCOUNTS(*), SDISPLS(*), SENDTYPE, RECVCOUNTS(*), RDISPLS(*),
57    RECVTYPES(*), COMM, IERROR

```

```

        RDISPLS, RECVMODE, COMM, REQUEST, IERROR)
        <type> SENDBUF(*), RECVMODE(*)
        INTEGER SENDCOUNTS(*), SDISPLS(*), SENDTYPE, RECVCOUNTS(*), RDISPLS(*),
        RECVTYPE, COMM, REQUEST, IERROR
MPI_IALLTOALLW(SENDBUF, SENDCOUNTS, SDISPLS, SENDTYPES, RECVMODE,
        RECVCOUNTS, RDISPLS, RECVTYPES, COMM, REQUEST, IERROR)
        <type> SENDBUF(*), RECVMODE(*)
        INTEGER SENDCOUNTS(*), SDISPLS(*), SENDTYPES(*), RECVCOUNTS(*),
        RDISPLS(*), RECVTYPES(*), COMM, REQUEST, IERROR
MPI_IBARRIER(COMM, REQUEST, IERROR)
        INTEGER COMM, REQUEST, IERROR
MPI_IBCAST(BUFFER, COUNT, DATATYPE, ROOT, COMM, REQUEST, IERROR)
        <type> BUFFER(*)
        INTEGER COUNT, DATATYPE, ROOT, COMM, REQUEST, IERROR
MPI_IEXSCAN(SENDBUF, RECVMODE, COUNT, DATATYPE, OP, COMM, REQUEST, IERROR)
        <type> SENDBUF(*), RECVMODE(*)
        INTEGER COUNT, DATATYPE, OP, COMM, REQUEST, IERROR
MPI_IGATHER(SENDBUF, SENDCOUNT, SENDTYPE, RECVMODE, RECVCOUNT, RECVTYPE,
        ROOT, COMM, REQUEST, IERROR)
        <type> SENDBUF(*), RECVMODE(*)
        INTEGER SENDCOUNT, SENDTYPE, RECVCOUNT, RECVTYPE, ROOT, COMM, REQUEST,
        IERROR
MPI_IGATHERV(SENDBUF, SENDCOUNT, SENDTYPE, RECVMODE, RECVCOUNTS, DISPLS,
        RECVTYPE, ROOT, COMM, REQUEST, IERROR)
        <type> SENDBUF(*), RECVMODE(*)
        INTEGER SENDCOUNT, SENDTYPE, RECVCOUNTS(*), DISPLS(*), RECVTYPE, ROOT,
        COMM, REQUEST, IERROR
MPI_IREDUCE_SCATTER_BLOCK(SENDBUF, RECVMODE, RECVCOUNT, DATATYPE, OP, COMM,
        REQUEST, IERROR)
        <type> SENDBUF(*), RECVMODE(*)
        INTEGER RECVCOUNT, DATATYPE, OP, COMM, REQUEST, IERROR
MPI_IREDUCE_SCATTER(SENDBUF, RECVMODE, RECVCOUNTS, DATATYPE, OP, COMM,
        REQUEST, IERROR)
        <type> SENDBUF(*), RECVMODE(*)
        INTEGER RECVCOUNTS(*), DATATYPE, OP, COMM, REQUEST, IERROR
MPI_IREDUCE(SENDBUF, RECVMODE, COUNT, DATATYPE, OP, ROOT, COMM, REQUEST,
        IERROR)
        <type> SENDBUF(*), RECVMODE(*)
        INTEGER COUNT, DATATYPE, OP, ROOT, COMM, REQUEST, IERROR
MPI_ISCAN(SENDBUF, RECVMODE, COUNT, DATATYPE, OP, COMM, REQUEST, IERROR)
        <type> SENDBUF(*), RECVMODE(*)
        INTEGER COUNT, DATATYPE, OP, COMM, REQUEST, IERROR

```

```

1 MPI_ISCATTER(SENDBUF, SENDCOUNT, SENDTYPE, RECVBUF, RECVCOUNT, RECVTYPE,
2             ROOT, COMM, REQUEST, IERROR)
3     <type> SENDBUF(*), RECVBUF(*)
4     INTEGER SENDCOUNT, SENDTYPE, RECVCOUNT, RECVTYPE, ROOT, COMM, REQUEST,
5     IERROR
6
7 MPI_ISCATTERV(SENDBUF, SENDCOUNTS, DISPLS, SENDTYPE, RECVBUF, RECVCOUNT,
8              RECVTYPE, ROOT, COMM, REQUEST, IERROR)
9     <type> SENDBUF(*), RECVBUF(*)
10    INTEGER SENDCOUNTS(*), DISPLS(*), SENDTYPE, RECVCOUNT, RECVTYPE, ROOT,
11    COMM, REQUEST, IERROR
12
13 MPI_OP_COMMUTATIVE(OP, COMMUTE, IERROR)
14     LOGICAL COMMUTE
15     INTEGER OP, IERROR
16
17 MPI_OP_CREATE( [FUNCTION]USER_FN, COMMUTE, OP, IERROR)
18     EXTERNAL [FUNCTION]USER_FN
19     LOGICAL COMMUTE
20     INTEGER OP, IERROR
21
22 MPI_OP_FREE(OP, IERROR)
23     INTEGER OP, IERROR
24
25 MPI_REDUCE_LOCAL(INBUF, INOUTBUF, COUNT, DATATYPE, OP, IERROR)
26     <type> INBUF(*), INOUTBUF(*)
27     INTEGER COUNT, DATATYPE, OP, IERROR
28
29 MPI_REDUCE_SCATTER_BLOCK(SENDBUF, RECVBUF, RECVCOUNT, DATATYPE, OP, COMM,
30                          IERROR)
31     <type> SENDBUF(*), RECVBUF(*)
32     INTEGER RECVCOUNT, DATATYPE, OP, COMM, IERROR
33
34 MPI_REDUCE_SCATTER(SENDBUF, RECVBUF, RECVCOUNTS, DATATYPE, OP, COMM,
35                   IERROR)
36     <type> SENDBUF(*), RECVBUF(*)
37     INTEGER RECVCOUNTS(*), DATATYPE, OP, COMM, IERROR
38
39 MPI_REDUCE(SENDBUF, RECVBUF, COUNT, DATATYPE, OP, ROOT, COMM, IERROR)
40     <type> SENDBUF(*), RECVBUF(*)
41     INTEGER COUNT, DATATYPE, OP, ROOT, COMM, IERROR
42
43 MPI_SCAN(SENDBUF, RECVBUF, COUNT, DATATYPE, OP, COMM, IERROR)
44     <type> SENDBUF(*), RECVBUF(*)
45     INTEGER COUNT, DATATYPE, OP, COMM, IERROR
46
47 MPI_SCATTER(SENDBUF, SENDCOUNT, SENDTYPE, RECVBUF, RECVCOUNT, RECVTYPE,
48            ROOT, COMM, IERROR)
49     <type> SENDBUF(*), RECVBUF(*)
50     INTEGER SENDCOUNT, SENDTYPE, RECVCOUNT, RECVTYPE, ROOT, COMM, IERROR
51
52 MPI_SCATTERV(SENDBUF, SENDCOUNTS, DISPLS, SENDTYPE, RECVBUF, RECVCOUNT,
53             RECVTYPE, ROOT, COMM, IERROR)

```



```

<type> SENDBUF(*), RECVBUF(*)
INTEGER SENDCOUNTS(*), DISPLS(*), SENDTYPE, RECVCOUNT, RECVMODE, ROOT,
COMM, IERROR
1
2
3
4
5
A.4.4 Groups, Contexts, Communicators, and Caching Fortran Bindings
6
MPI_COMM_COMPARE(COMM1, COMM2, RESULT, IERROR)
7
INTEGER COMM1, COMM2, RESULT, IERROR
8
9
MPI_COMM_CREATE(COMM, GROUP, NEWCOMM, IERROR)
10
INTEGER COMM, GROUP, NEWCOMM, IERROR
11
MPI_COMM_CREATE_KEYVAL(COMM_COPY_ATTR_FN, COMM_DELETE_ATTR_FN, COMM_KEYVAL,
12
EXTRA_STATE, IERROR)
13
EXTERNAL COMM_COPY_ATTR_FN, COMM_DELETE_ATTR_FN
14
INTEGER COMM_KEYVAL, IERROR
15
INTEGER(KIND=MPI_ADDRESS_KIND) EXTRA_STATE
16
17
MPI_COMM_DELETE_ATTR(COMM, COMM_KEYVAL, IERROR)
18
INTEGER COMM, COMM_KEYVAL, IERROR
19
20
MPI_COMM_DUP(COMM, NEWCOMM, IERROR)
21
INTEGER COMM, NEWCOMM, IERROR
22
MPI_COMM_DUP_FN(OLDCOMM, COMM_KEYVAL, EXTRA_STATE, ATTRIBUTE_VAL_IN,
23
ATTRIBUTE_VAL_OUT, FLAG, IERROR)
24
INTEGER OLDCOMM, COMM_KEYVAL, IERROR
25
INTEGER(KIND=MPI_ADDRESS_KIND) EXTRA_STATE, ATTRIBUTE_VAL_IN,
26
ATTRIBUTE_VAL_OUT
27
LOGICAL FLAG
28
29
MPI_COMM_FREE(COMM, IERROR)
30
INTEGER COMM, IERROR
31
32
MPI_COMM_FREE_KEYVAL(COMM_KEYVAL, IERROR)
33
INTEGER COMM_KEYVAL, IERROR
34
35
MPI_COMM_GET_ATTR(COMM, COMM_KEYVAL, ATTRIBUTE_VAL, FLAG, IERROR)
36
INTEGER COMM, COMM_KEYVAL, IERROR
37
INTEGER(KIND=MPI_ADDRESS_KIND) ATTRIBUTE_VAL
38
LOGICAL FLAG
39
40
MPI_COMM_GET_NAME(COMM, COMM_NAME, RESULTLEN, IERROR)
41
INTEGER COMM, RESULTLEN, IERROR
42
CHARACTER*(*) COMM_NAME
43
44
MPI_COMM_GROUP(COMM, GROUP, IERROR)
45
INTEGER COMM, GROUP, IERROR
46
47
MPI_COMM_NULL_COPY_FN(OLDCOMM, COMM_KEYVAL, EXTRA_STATE, ATTRIBUTE_VAL_IN,
48
ATTRIBUTE_VAL_OUT, FLAG, IERROR)
49
INTEGER OLDCOMM, COMM_KEYVAL, IERROR
50
INTEGER(KIND=MPI_ADDRESS_KIND) EXTRA_STATE, ATTRIBUTE_VAL_IN,
51
ATTRIBUTE_VAL_OUT, FLAG, IERROR
52

```

```

1      ATTRIBUTE_VAL_OUT
2      LOGICAL FLAG
3
4      MPI_COMM_NULL_DELETE_FN(COMM, COMM_KEYVAL, ATTRIBUTE_VAL, EXTRA_STATE,
5          IERROR)
6          INTEGER COMM, COMM_KEYVAL, IERROR
7          INTEGER(KIND=MPI_ADDRESS_KIND) ATTRIBUTE_VAL, EXTRA_STATE
8
9      MPI_COMM_RANK(COMM, RANK, IERROR)
10         INTEGER COMM, RANK, IERROR
11
12     MPI_COMM_REMOTE_GROUP(COMM, GROUP, IERROR)
13         INTEGER COMM, GROUP, IERROR
14
15     MPI_COMM_REMOTE_SIZE(COMM, SIZE, IERROR)
16         INTEGER COMM, SIZE, IERROR
17
18     MPI_COMM_SET_ATTR(COMM, COMM_KEYVAL, ATTRIBUTE_VAL, IERROR)
19         INTEGER COMM, COMM_KEYVAL, IERROR
20         INTEGER(KIND=MPI_ADDRESS_KIND) ATTRIBUTE_VAL
21
22     MPI_COMM_SET_NAME(COMM, COMM_NAME, IERROR)
23         INTEGER COMM, IERROR
24         CHARACTER*(*) COMM_NAME
25
26     MPI_COMM_SIZE(COMM, SIZE, IERROR)
27         INTEGER COMM, SIZE, IERROR
28
29     MPI_COMM_SPLIT(COMM, COLOR, KEY, NEWCOMM, IERROR)
30         INTEGER COMM, COLOR, KEY, NEWCOMM, IERROR
31
32     MPI_COMM_SPLIT_TYPE(COMM, SPLIT_TYPE, KEY, INFO, NEWCOMM, IERROR)
33         INTEGER COMM, SPLIT_TYPE, KEY, INFO, NEWCOMM, IERROR
34
35     MPI_COMM_TEST_INTER(COMM, FLAG, IERROR)
36         INTEGER COMM, IERROR
37         LOGICAL FLAG
38
39     MPI_GROUP_COMPARE(GROUP1, GROUP2, RESULT, IERROR)
40         INTEGER GROUP1, GROUP2, RESULT, IERROR
41
42     MPI_GROUP_DIFFERENCE(GROUP1, GROUP2, NEWGROUP, IERROR)
43         INTEGER GROUP1, GROUP2, NEWGROUP, IERROR
44
45     MPI_GROUP_EXCL(GROUP, N, RANKS, NEWGROUP, IERROR)
46         INTEGER GROUP, N, RANKS(*), NEWGROUP, IERROR
47
48     MPI_GROUP_FREE(GROUP, IERROR)
49         INTEGER GROUP, IERROR
50
51     MPI_GROUP_INCL(GROUP, N, RANKS, NEWGROUP, IERROR)
52         INTEGER GROUP, N, RANKS(*), NEWGROUP, IERROR
53
54     MPI_GROUP_INTERSECTION(GROUP1, GROUP2, NEWGROUP, IERROR)
55         INTEGER GROUP1, GROUP2, NEWGROUP, IERROR

```

```

MPI_GROUP_RANGE_EXCL(GROUP, N, RANGES, NEWGROUP, IERROR)           1
    INTEGER GROUP, N, RANGES(3,*), NEWGROUP, IERROR                2
                                                                    3
MPI_GROUP_RANGE_INCL(GROUP, N, RANGES, NEWGROUP, IERROR)          4
    INTEGER GROUP, N, RANGES(3,*), NEWGROUP, IERROR                5
                                                                    6
MPI_GROUP_RANK(GROUP, RANK, IERROR)                                 7
    INTEGER GROUP, RANK, IERROR                                      8
                                                                    9
MPI_GROUP_SIZE(GROUP, SIZE, IERROR)                                10
    INTEGER GROUP, SIZE, IERROR                                     11
                                                                    12
MPI_GROUP_TRANSLATE_RANKS(GROUP1, N, RANKS1, GROUP2, RANKS2, IERROR) 13
    INTEGER GROUP1, N, RANKS1(*), GROUP2, RANKS2(*), IERROR        14
                                                                    15
MPI_GROUP_UNION(GROUP1, GROUP2, NEWGROUP, IERROR)                  16
    INTEGER GROUP1, GROUP2, NEWGROUP, IERROR                        17
                                                                    18
MPI_INTERCOMM_CREATE(LOCAL_COMM, LOCAL_LEADER, PEER_COMM, REMOTE_LEADER,
    TAG, NEWINTERCOMM, IERROR)                                     19
    INTEGER LOCAL_COMM, LOCAL_LEADER, PEER_COMM, REMOTE_LEADER, TAG,
    NEWINTERCOMM, IERROR                                           20
                                                                    21
MPI_INTERCOMM_MERGE(INTERCOMM, HIGH, NEWINTRACOMM, IERROR)        22
    INTEGER INTERCOMM, NEWINTRACOMM, IERROR                         23
    LOGICAL HIGH                                                    24
                                                                    25
MPI_TYPE_CREATE_KEYVAL(TYPE_COPY_ATTR_FN, TYPE_DELETE_ATTR_FN, TYPE_KEYVAL,
    EXTRA_STATE, IERROR)                                         26
    EXTERNAL TYPE_COPY_ATTR_FN, TYPE_DELETE_ATTR_FN                 27
    INTEGER TYPE_KEYVAL, IERROR                                     28
    INTEGER(KIND=MPI_ADDRESS_KIND) EXTRA_STATE                     29
                                                                    30
MPI_TYPE_DELETE_ATTR(DATATYPE, TYPE_KEYVAL, IERROR)               31
    INTEGER DATATYPE, TYPE_KEYVAL, IERROR                           32
                                                                    33
MPI_TYPE_DUP_FN(OLDTYPE, TYPE_KEYVAL, EXTRA_STATE, ATTRIBUTE_VAL_IN,
    ATTRIBUTE_VAL_OUT, FLAG, IERROR)                               34
    INTEGER OLDTYPE, TYPE_KEYVAL, IERROR                            35
    INTEGER(KIND=MPI_ADDRESS_KIND) EXTRA_STATE, ATTRIBUTE_VAL_IN,
    ATTRIBUTE_VAL_OUT                                               36
    LOGICAL FLAG                                                    37
                                                                    38
MPI_TYPE_FREE_KEYVAL(TYPE_KEYVAL, IERROR)                          39
    INTEGER TYPE_KEYVAL, IERROR                                     40
                                                                    41
MPI_TYPE_GET_ATTR(DATATYPE, TYPE_KEYVAL, ATTRIBUTE_VAL, FLAG, IERROR) 42
    INTEGER DATATYPE, TYPE_KEYVAL, IERROR                           43
    INTEGER(KIND=MPI_ADDRESS_KIND) ATTRIBUTE_VAL                     44
    LOGICAL FLAG                                                    45
                                                                    46
MPI_TYPE_GET_NAME(DATATYPE, TYPE_NAME, RESULTLEN, IERROR)         47
    INTEGER DATATYPE, RESULTLEN, IERROR                             48
    CHARACTER*(*) TYPE_NAME

```

```

1 MPI_TYPE_NULL_COPY_FN(OLDTYPE, TYPE_KEYVAL, EXTRA_STATE, ATTRIBUTE_VAL_IN,
2     ATTRIBUTE_VAL_OUT, FLAG, IERROR)
3     INTEGER OLDTYPE, TYPE_KEYVAL, IERROR
4     INTEGER(KIND=MPI_ADDRESS_KIND) EXTRA_STATE, ATTRIBUTE_VAL_IN,
5     ATTRIBUTE_VAL_OUT
6     LOGICAL FLAG
7
ticket252-W. 8 MPI_TYPE_NULL_DELETE_FN(DATATYPE, TYPE_KEYVAL, ATTRIBUTE_VAL, EXTRA_STATE,
9     IERROR)
ticket252-W. 10     INTEGER DATATYPE, TYPE_KEYVAL, IERROR
11     INTEGER(KIND=MPI_ADDRESS_KIND) ATTRIBUTE_VAL, EXTRA_STATE
12
ticket252-W. 12 MPI_TYPE_SET_ATTR(DATATYPE, TYPE_KEYVAL, ATTRIBUTE_VAL, IERROR)
ticket252-W. 13     INTEGER DATATYPE, TYPE_KEYVAL, IERROR
14     INTEGER(KIND=MPI_ADDRESS_KIND) ATTRIBUTE_VAL
15
ticket252-W. 16 MPI_TYPE_SET_NAME(DATATYPE, TYPE_NAME, IERROR)
ticket252-W. 17     INTEGER DATATYPE, IERROR
18     CHARACTER*(*) TYPE_NAME
19
20 MPI_WIN_CREATE_KEYVAL(WIN_COPY_ATTR_FN, WIN_DELETE_ATTR_FN, WIN_KEYVAL,
21     EXTRA_STATE, IERROR)
22     EXTERNAL WIN_COPY_ATTR_FN, WIN_DELETE_ATTR_FN
23     INTEGER WIN_KEYVAL, IERROR
24     INTEGER(KIND=MPI_ADDRESS_KIND) EXTRA_STATE
25
26 MPI_WIN_DELETE_ATTR(WIN, WIN_KEYVAL, IERROR)
27     INTEGER WIN, WIN_KEYVAL, IERROR
28
29 MPI_WIN_DUP_FN(OLDWIN, WIN_KEYVAL, EXTRA_STATE, ATTRIBUTE_VAL_IN,
30     ATTRIBUTE_VAL_OUT, FLAG, IERROR)
31     INTEGER OLDWIN, WIN_KEYVAL, IERROR
32     INTEGER(KIND=MPI_ADDRESS_KIND) EXTRA_STATE, ATTRIBUTE_VAL_IN,
33     ATTRIBUTE_VAL_OUT
34     LOGICAL FLAG
35
36 MPI_WIN_FREE_KEYVAL(WIN_KEYVAL, IERROR)
37     INTEGER WIN_KEYVAL, IERROR
38
39 MPI_WIN_GET_ATTR(WIN, WIN_KEYVAL, ATTRIBUTE_VAL, FLAG, IERROR)
40     INTEGER WIN, WIN_KEYVAL, IERROR
41     INTEGER(KIND=MPI_ADDRESS_KIND) ATTRIBUTE_VAL
42     LOGICAL FLAG
43
44 MPI_WIN_GET_NAME(WIN, WIN_NAME, RESULTLEN, IERROR)
45     INTEGER WIN, RESULTLEN, IERROR
46     CHARACTER*(*) WIN_NAME
47
48 MPI_WIN_NULL_COPY_FN(OLDWIN, WIN_KEYVAL, EXTRA_STATE, ATTRIBUTE_VAL_IN,
49     ATTRIBUTE_VAL_OUT, FLAG, IERROR)
50     INTEGER OLDWIN, WIN_KEYVAL, IERROR
51     INTEGER(KIND=MPI_ADDRESS_KIND) EXTRA_STATE, ATTRIBUTE_VAL_IN,
52     ATTRIBUTE_VAL_OUT, FLAG, IERROR

```

ATTRIBUTE_VAL_OUT	1
LOGICAL FLAG	2
MPI_WIN_NULL_DELETE_FN(WIN, WIN_KEYVAL, ATTRIBUTE_VAL, EXTRA_STATE, IERROR)	3
INTEGER WIN, WIN_KEYVAL, IERROR	4
INTEGER(KIND=MPI_ADDRESS_KIND) ATTRIBUTE_VAL, EXTRA_STATE	5
MPI_WIN_SET_ATTR(WIN, WIN_KEYVAL, ATTRIBUTE_VAL, IERROR)	6
INTEGER WIN, WIN_KEYVAL, IERROR	7
INTEGER(KIND=MPI_ADDRESS_KIND) ATTRIBUTE_VAL	8
MPI_WIN_SET_NAME(WIN, WIN_NAME, IERROR)	9
INTEGER WIN, IERROR	10
CHARACTER*(*) WIN_NAME	11
	12
	13
	14
A.4.5 Process Topologies Fortran Bindings	15
MPI_CART_COORDS(COMM, RANK, MAXDIMS, COORDS, IERROR)	16
INTEGER COMM, RANK, MAXDIMS, COORDS(*), IERROR	17
MPI_CART_CREATE(COMM_OLD, NDIMS, DIMS, PERIODS, REORDER, COMM_CART, IERROR)	18
INTEGER COMM_OLD, NDIMS, DIMS(*), COMM_CART, IERROR	19
LOGICAL PERIODS(*), REORDER	20
MPI_CARTDIM_GET(COMM, NDIMS, IERROR)	21
INTEGER COMM, NDIMS, IERROR	22
MPI_CART_GET(COMM, MAXDIMS, DIMS, PERIODS, COORDS, IERROR)	23
INTEGER COMM, MAXDIMS, DIMS(*), COORDS(*), IERROR	24
LOGICAL PERIODS(*)	25
MPI_CART_MAP(COMM, NDIMS, DIMS, PERIODS, NEWRANK, IERROR)	26
INTEGER COMM, NDIMS, DIMS(*), NEWRANK, IERROR	27
LOGICAL PERIODS(*)	28
MPI_CART_RANK(COMM, COORDS, RANK, IERROR)	29
INTEGER COMM, COORDS(*), RANK, IERROR	30
MPI_CART_SHIFT(COMM, DIRECTION, DISP, RANK_SOURCE, RANK_DEST, IERROR)	31
INTEGER COMM, DIRECTION, DISP, RANK_SOURCE, RANK_DEST, IERROR	32
MPI_CART_SUB(COMM, REMAIN_DIMS, NEWCOMM, IERROR)	33
INTEGER COMM, NEWCOMM, IERROR	34
LOGICAL REMAIN_DIMS(*)	35
MPI_DIMS_CREATE(NNODES, NDIMS, DIMS, IERROR)	36
INTEGER NNODES, NDIMS, DIMS(*), IERROR	37
MPI_DIST_GRAPH_CREATE_ADJACENT(COMM_OLD, INDEGREE, SOURCES, SOURCEWEIGHTS, OUTDEGREE, DESTINATIONS, DESTWEIGHTS, INFO, REORDER, COMM_DIST_GRAPH, IERROR)	38
INTEGER COMM_OLD, INDEGREE, SOURCES(*), SOURCEWEIGHTS(*), OUTDEGREE, DESTINATIONS(*), DESTWEIGHTS(*), INFO, COMM_DIST_GRAPH, IERROR	39
	40
	41
	42
	43
	44
	45
	46
	47
	48

```

1     LOGICAL REORDER
2
3     MPI_DIST_GRAPH_CREATE(COMM_OLD, N, SOURCES, DEGREES, DESTINATIONS, WEIGHTS,
4         INFO, REORDER, COMM_DIST_GRAPH, IERROR)
5     INTEGER COMM_OLD, N, SOURCES(*), DEGREES(*), DESTINATIONS(*),
6     WEIGHTS(*), INFO, COMM_DIST_GRAPH, IERROR
7     LOGICAL REORDER
8
9     MPI_DIST_GRAPH_NEIGHBORS(COMM, MAXINDEGREE, SOURCES, SOURCEWEIGHTS,
10        MAXOUTDEGREE, DESTINATIONS, DESTWEIGHTS, IERROR)
11    INTEGER COMM, MAXINDEGREE, SOURCES(*), SOURCEWEIGHTS(*), MAXOUTDEGREE,
12    DESTINATIONS(*), DESTWEIGHTS(*), IERROR
13
14    MPI_DIST_GRAPH_NEIGHBORS_COUNT(COMM, INDEGREE, OUTDEGREE, WEIGHTED, IERROR)
15    INTEGER COMM, INDEGREE, OUTDEGREE, IERROR
16    LOGICAL WEIGHTED
17
18    MPI_GRAPH_CREATE(COMM_OLD, NNODES, INDEX, EDGES, REORDER, COMM_GRAPH,
19        IERROR)
20    INTEGER COMM_OLD, NNODES, INDEX(*), EDGES(*), COMM_GRAPH, IERROR
21    LOGICAL REORDER
22
23    MPI_GRAPHDIMS_GET(COMM, NNODES, NEDGES, IERROR)
24    INTEGER COMM, NNODES, NEDGES, IERROR
25
26    MPI_GRAPH_GET(COMM, MAXINDEX, MAXEDGES, INDEX, EDGES, IERROR)
27    INTEGER COMM, MAXINDEX, MAXEDGES, INDEX(*), EDGES(*), IERROR
28
29    MPI_GRAPH_MAP(COMM, NNODES, INDEX, EDGES, NEWRANK, IERROR)
30    INTEGER COMM, NNODES, INDEX(*), EDGES(*), NEWRANK, IERROR
31
32    MPI_GRAPH_NEIGHBORS(COMM, RANK, MAXNEIGHBORS, NEIGHBORS, IERROR)
33    INTEGER COMM, RANK, MAXNEIGHBORS, NEIGHBORS(*), IERROR
34
35    MPI_GRAPH_NEIGHBORS_COUNT(COMM, RANK, NNEIGHBORS, IERROR)
36    INTEGER COMM, RANK, NNEIGHBORS, IERROR
37
38    MPI_INEIGHBOR_ALLGATHER(SENDBUF, SENDCOUNT, SENDTYPE, RECVBUFF, RECVCOUNT,
39        RECVMODE, COMM, REQUEST, IERROR)
40    <type> SENDBUF(*), RECVBUFF(*)
41    INTEGER SENDCOUNT, SENDTYPE, RECVCOUNT, RECVMODE, COMM, REQUEST, IERROR
42
43    MPI_INEIGHBOR_ALLGATHERV(SENDBUF, SENDCOUNT, SENDTYPE, RECVBUFF, RECVCOUNTS,
44        DISPLS, RECVMODE, COMM, REQUEST, IERROR)
45    <type> SENDBUF(*), RECVBUFF(*)
46    INTEGER SENDCOUNT, SENDTYPE, RECVCOUNTS(*), DISPLS(*), RECVMODE, COMM,
47    REQUEST, IERROR
48
49    MPI_INEIGHBOR_ALLTOALL(SENDBUF, SENDCOUNT, SENDTYPE, RECVBUFF, RECVCOUNT,
50        RECVMODE, COMM, REQUEST, IERROR)
51    <type> SENDBUF(*), RECVBUFF(*)
52    INTEGER SENDCOUNT, SENDTYPE, RECVCOUNT, RECVMODE, COMM, REQUEST, IERROR
53
54    MPI_INEIGHBOR_ALLTOALLV(SENDBUF, SENDCOUNTS, SDISPLS, SENDTYPE, RECVBUFF,

```

```

    RECVCOUNTS, RDISPLS, RECVTYPE, COMM, REQUEST, IERROR)
    <type> SENDBUF(*), RECVBUF(*)
    INTEGER SENDCOUNTS(*), SDISPLS(*), SENDTYPE, RECVCOUNTS(*), RDISPLS(*),
    RECVTYPE, COMM, REQUEST, IERROR
MPI_INEIGHBOR_ALLTOALLW(SENDBUF, SENDCOUNTS, SDISPLS, SENDTYPES, RECVBUF,
    RECVCOUNTS, RDISPLS, RECVTYPES, COMM, REQUEST, IERROR)
    <type> SENDBUF(*), RECVBUF(*)
    INTEGER(KIND=MPI_ADDRESS_KIND) SDISPLS(*), RDISPLS(*)
    INTEGER SENDCOUNTS(*), SENDTYPES(*), RECVCOUNTS(*), RECVTYPES(*), COMM,
    REQUEST, IERROR
MPI_NEIGHBOR_ALLGATHER(SENDBUF, SENDCOUNT, SENDTYPE, RECVBUF, RECVCOUNT,
    RECVTYPE, COMM, IERROR)
    <type> SENDBUF(*), RECVBUF(*)
    INTEGER SENDCOUNT, SENDTYPE, RECVCOUNT, RECVTYPE, COMM, IERROR
MPI_NEIGHBOR_ALLGATHERV(SENDBUF, SENDCOUNT, SENDTYPE, RECVBUF, RECVCOUNTS,
    DISPLS, RECVTYPE, COMM, IERROR)
    <type> SENDBUF(*), RECVBUF(*)
    INTEGER SENDCOUNT, SENDTYPE, RECVCOUNTS(*), DISPLS(*), RECVTYPE, COMM,
    IERROR
MPI_NEIGHBOR_ALLTOALL(SENDBUF, SENDCOUNT, SENDTYPE, RECVBUF, RECVCOUNT,
    RECVTYPE, COMM, IERROR)
    <type> SENDBUF(*), RECVBUF(*)
    INTEGER SENDCOUNT, SENDTYPE, RECVCOUNT, RECVTYPE, COMM, IERROR
MPI_NEIGHBOR_ALLTOALLV(SENDBUF, SENDCOUNTS, SDISPLS, SENDTYPE, RECVBUF,
    RECVCOUNTS, RDISPLS, RECVTYPE, COMM, IERROR)
    <type> SENDBUF(*), RECVBUF(*)
    INTEGER SENDCOUNTS(*), SDISPLS(*), SENDTYPE, RECVCOUNTS(*), RDISPLS(*),
    RECVTYPE, COMM, IERROR
MPI_NEIGHBOR_ALLTOALLW(SENDBUF, SENDCOUNTS, SDISPLS, SENDTYPES, RECVBUF,
    RECVCOUNTS, RDISPLS, RECVTYPES, COMM, IERROR)
    <type> SENDBUF(*), RECVBUF(*)
    INTEGER(KIND=MPI_ADDRESS_KIND) SDISPLS(*), RDISPLS(*)
    INTEGER SENDCOUNTS(*), SENDTYPES(*), RECVCOUNTS(*), RECVTYPES(*), COMM,
    IERROR
MPI_TOPO_TEST(COMM, STATUS, IERROR)
    INTEGER COMM, STATUS, IERROR

```

A.4.6 MPI Environmental Management Fortran Bindings

```

DOUBLE PRECISION MPI_WTICK()
DOUBLE PRECISION MPI_WTIME()
MPI_ABORT(COMM, ERRORCODE, IERROR)
    INTEGER COMM, ERRORCODE, IERROR

```

```

1 MPI_ADD_ERROR_CLASS(ERRORCLASS, IERROR)
2     INTEGER ERRORCLASS, IERROR
3
4 MPI_ADD_ERROR_CODE(ERRORCLASS, ERRORCODE, IERROR)
5     INTEGER ERRORCLASS, ERRORCODE, IERROR
6
6 MPI_ADD_ERROR_STRING(ERRORCODE, STRING, IERROR)
7     INTEGER ERRORCODE, IERROR
8     CHARACTER*(*) STRING
9
10 MPI_ALLOC_MEM(SIZE, INFO, BASEPTR, IERROR)
11     INTEGER INFO, IERROR
12     INTEGER(KIND=MPI_ADDRESS_KIND) SIZE, BASEPTR
13
13 MPI_COMM_CALL_ERRHANDLER(COMM, ERRORCODE, IERROR)
14     INTEGER COMM, ERRORCODE, IERROR
15
ticket252-W. 16 MPI_COMM_CREATE_ERRHANDLER([FUNCTION] COMM_ERRHANDLER_FN, ERRHANDLER,
17     IERROR)
ticket252-W. 18     EXTERNAL [FUNCTION] COMM_ERRHANDLER_FN
19     INTEGER ERRHANDLER, IERROR
20
20 MPI_COMM_GET_ERRHANDLER(COMM, ERRHANDLER, IERROR)
21     INTEGER COMM, ERRHANDLER, IERROR
22
23 MPI_COMM_SET_ERRHANDLER(COMM, ERRHANDLER, IERROR)
24     INTEGER COMM, ERRHANDLER, IERROR
25
25 MPI_ERRHANDLER_FREE(ERRHANDLER, IERROR)
26     INTEGER ERRHANDLER, IERROR
27
28 MPI_ERROR_CLASS(ERRORCODE, ERRORCLASS, IERROR)
29     INTEGER ERRORCODE, ERRORCLASS, IERROR
30
30 MPI_ERROR_STRING(ERRORCODE, STRING, RESULTLEN, IERROR)
31     INTEGER ERRORCODE, RESULTLEN, IERROR
32     CHARACTER*(*) STRING
33
34 MPI_FILE_CALL_ERRHANDLER(FH, ERRORCODE, IERROR)
35     INTEGER FH, ERRORCODE, IERROR
36
ticket252-W. 36 MPI_FILE_CREATE_ERRHANDLER([FUNCTION] FILE_ERRHANDLER_FN, ERRHANDLER,
37     IERROR)
ticket252-W. 38     EXTERNAL [FUNCTION] FILE_ERRHANDLER_FN
39     INTEGER ERRHANDLER, IERROR
40
41 MPI_FILE_GET_ERRHANDLER(FILE, ERRHANDLER, IERROR)
42     INTEGER FILE, ERRHANDLER, IERROR
43
44 MPI_FILE_SET_ERRHANDLER(FILE, ERRHANDLER, IERROR)
45     INTEGER FILE, ERRHANDLER, IERROR
46
46 MPI_FINALIZED(FLAG, IERROR)
47     LOGICAL FLAG
48     INTEGER IERROR

```

MPI_FINALIZE(IERROR)	1
INTEGER IERROR	2
	3
MPI_FREE_MEM(BASE, IERROR)	4
<type> BASE(*)	5
INTEGER IERROR	6
	7
MPI_GET_LIBRARY_VERSION(VERSION, RESULTEN, IERROR)	8
CHARACTER*(*) VERSION	9
INTEGER RESULTLEN, IERROR	10
	11
MPI_GET_PROCESSOR_NAME(NAME, RESULTLEN, IERROR)	12
CHARACTER*(*) NAME	13
INTEGER RESULTLEN, IERROR	14
	15
MPI_GET_VERSION(VERSION, SUBVERSION, IERROR)	16
INTEGER VERSION, SUBVERSION, IERROR	17
	18
MPI_INITIALIZED(FLAG, IERROR)	19
LOGICAL FLAG	20
INTEGER IERROR	21
	22
MPI_INIT(IERROR)	23
INTEGER IERROR	24
	25
MPI_WIN_CALL_ERRHANDLER(WIN, ERRORCODE, IERROR)	26
INTEGER WIN, ERRORCODE, IERROR	27
	28
MPI_WIN_CREATE_ERRHANDLER([FUNCTION]WIN_ERRHANDLER_FN, ERRHANDLER, IERROR)	29
EXTERNAL [FUNCTION]WIN_ERRHANDLER_FN	30
INTEGER ERRHANDLER, IERROR	31
	32
MPI_WIN_GET_ERRHANDLER(WIN, ERRHANDLER, IERROR)	33
INTEGER WIN, ERRHANDLER, IERROR	34
	35
MPI_WIN_SET_ERRHANDLER(WIN, ERRHANDLER, IERROR)	36
INTEGER WIN, ERRHANDLER, IERROR	37
	38
	39
A.4.7 The Info Object Fortran Bindings	40
	41
MPI_INFO_CREATE(INFO, IERROR)	42
INTEGER INFO, IERROR	43
	44
MPI_INFO_DELETE(INFO, KEY, IERROR)	45
INTEGER INFO, IERROR	46
CHARACTER*(*) KEY	47
	48
MPI_INFO_DUP(INFO, NEWINFO, IERROR)	
INTEGER INFO, NEWINFO, IERROR	
MPI_INFO_FREE(INFO, IERROR)	
INTEGER INFO, IERROR	
MPI_INFO_GET(INFO, KEY, VALUELEN, VALUE, FLAG, IERROR)	

ticket252-W.
ticket252-W.

```

1      INTEGER INFO, VALUELEN, IERROR
2      CHARACTER*(*) KEY, VALUE
3      LOGICAL FLAG
4
5      MPI_INFO_GET_NKEYS(INFO, NKEYS, IERROR)
6          INTEGER INFO, NKEYS, IERROR
7
8      MPI_INFO_GET_NTHKEY(INFO, N, KEY, IERROR)
9          INTEGER INFO, N, IERROR
10         CHARACTER*(*) KEY
11
12     MPI_INFO_GET_VALUELEN(INFO, KEY, VALUELEN, FLAG, IERROR)
13         INTEGER INFO, VALUELEN, IERROR
14         LOGICAL FLAG
15         CHARACTER*(*) KEY
16
17     MPI_INFO_SET(INFO, KEY, VALUE, IERROR)
18         INTEGER INFO, IERROR
19         CHARACTER*(*) KEY, VALUE
20
21 A.4.8 Process Creation and Management Fortran Bindings
22
23 MPI_CLOSE_PORT(PORT_NAME, IERROR)
24     CHARACTER*(*) PORT_NAME
25     INTEGER IERROR
26
27 MPI_COMM_ACCEPT(PORT_NAME, INFO, ROOT, COMM, NEWCOMM, IERROR)
28     CHARACTER*(*) PORT_NAME
29     INTEGER INFO, ROOT, COMM, NEWCOMM, IERROR
30
31 MPI_COMM_CONNECT(PORT_NAME, INFO, ROOT, COMM, NEWCOMM, IERROR)
32     CHARACTER*(*) PORT_NAME
33     INTEGER INFO, ROOT, COMM, NEWCOMM, IERROR
34
35 MPI_COMM_DISCONNECT(COMM, IERROR)
36     INTEGER COMM, IERROR
37
38 MPI_COMM_GET_PARENT(PARENT, IERROR)
39     INTEGER PARENT, IERROR
40
41 MPI_COMM_JOIN(FD, INTERCOMM, IERROR)
42     INTEGER FD, INTERCOMM, IERROR
43
44 MPI_COMM_SPAWN(COMMAND, ARGV, MAXPROCS, INFO, ROOT, COMM, INTERCOMM,
45     ARRAY_OF_ERRCODES, IERROR)
46     CHARACTER*(*) COMMAND, ARGV(*)
47     INTEGER INFO, MAXPROCS, ROOT, COMM, INTERCOMM, ARRAY_OF_ERRCODES(*),
48     IERROR

```

```

    INTEGER COUNT, ARRAY_OF_INFO(*), ARRAY_OF_MAXPROCS(*), ROOT, COMM,
    INTERCOMM, ARRAY_OF_ERRCODES(*), IERROR
    CHARACTER*(*) ARRAY_OF_COMMANDS(*), ARRAY_OF_ARGV(COUNT, *)
MPI_LOOKUP_NAME(SERVICE_NAME, INFO, PORT_NAME, IERROR)
    CHARACTER*(*) SERVICE_NAME, PORT_NAME
    INTEGER INFO, IERROR
MPI_OPEN_PORT(INFO, PORT_NAME, IERROR)
    CHARACTER*(*) PORT_NAME
    INTEGER INFO, IERROR
MPI_PUBLISH_NAME(SERVICE_NAME, INFO, PORT_NAME, IERROR)
    INTEGER INFO, IERROR
    CHARACTER*(*) SERVICE_NAME, PORT_NAME
MPI_UNPUBLISH_NAME(SERVICE_NAME, INFO, PORT_NAME, IERROR)
    INTEGER INFO, IERROR
    CHARACTER*(*) SERVICE_NAME, PORT_NAME

```

A.4.9 One-Sided Communications Fortran Bindings

```

MPI_ACCUMULATE(ORIGIN_ADDR, ORIGIN_COUNT, ORIGIN_DATATYPE, TARGET_RANK,
    TARGET_DISP, TARGET_COUNT, TARGET_DATATYPE, OP, WIN, IERROR)
    <type> ORIGIN_ADDR(*)
    INTEGER(KIND=MPI_ADDRESS_KIND) TARGET_DISP
    INTEGER ORIGIN_COUNT, ORIGIN_DATATYPE, TARGET_RANK, TARGET_COUNT,
    TARGET_DATATYPE, OP, WIN, IERROR
MPI_COMPARE_AND_SWAP(ORIGIN_ADDR, COMPARE_ADDR, RESULT_ADDR, DATATYPE,
    TARGET_RANK, TARGET_DISP, WIN, IERROR)
    <type> ORIGIN_ADDR(*), COMPARE_ADDR(*), RESULT_ADDR(*)
    INTEGER(KIND=MPI_ADDRESS_KIND) TARGET_DISP
    INTEGER DATATYPE, TARGET_RANK, WIN, IERROR
MPI_FETCH_AND_OP(ORIGIN_ADDR, RESULT_ADDR, DATATYPE, TARGET_RANK,
    TARGET_DISP, OP, WIN, IERROR)
    <type> ORIGIN_ADDR(*), RESULT_ADDR(*)
    INTEGER(KIND=MPI_ADDRESS_KIND) TARGET_DISP
    INTEGER DATATYPE, TARGET_RANK, OP, WIN, IERROR
MPI_GET_ACCUMULATE(ORIGIN_ADDR, ORIGIN_COUNT, ORIGIN_DATATYPE, RESULT_ADDR,
    RESULT_COUNT, RESULT_DATATYPE, TARGET_RANK, TARGET_DISP,
    TARGET_COUNT, TARGET_DATATYPE, OP, WIN, IERROR)
    <type> ORIGIN_ADDR(*), RESULT_ADDR(*)
    INTEGER(KIND=MPI_ADDRESS_KIND) TARGET_DISP
    INTEGER ORIGIN_COUNT, ORIGIN_DATATYPE, RESULT_COUNT, RESULT_DATATYPE,
    TARGET_RANK, TARGET_COUNT, TARGET_DATATYPE, OP, WIN, IERROR
MPI_GET(ORIGIN_ADDR, ORIGIN_COUNT, ORIGIN_DATATYPE, TARGET_RANK,
    TARGET_DISP, TARGET_COUNT, TARGET_DATATYPE, WIN, IERROR)

```

```

1     <type> ORIGIN_ADDR(*)
2     INTEGER(KIND=MPI_ADDRESS_KIND) TARGET_DISP
3     INTEGER ORIGIN_COUNT, ORIGIN_DATATYPE, TARGET_RANK, TARGET_COUNT,
4     TARGET_DATATYPE, WIN, IERROR
5
6     MPI_PUT(ORIGIN_ADDR, ORIGIN_COUNT, ORIGIN_DATATYPE, TARGET_RANK,
7             TARGET_DISP, TARGET_COUNT, TARGET_DATATYPE, WIN, IERROR)
8     <type> ORIGIN_ADDR(*)
9     INTEGER(KIND=MPI_ADDRESS_KIND) TARGET_DISP
10    INTEGER ORIGIN_COUNT, ORIGIN_DATATYPE, TARGET_RANK, TARGET_COUNT,
11    TARGET_DATATYPE, WIN, IERROR
12
13    MPI_RACCUMULATE(ORIGIN_ADDR, ORIGIN_COUNT, ORIGIN_DATATYPE, TARGET_RANK,
14                   TARGET_DISP, TARGET_COUNT, TARGET_DATATYPE, OP, WIN, REQUEST,
15                   IERROR)
16    <type> ORIGIN_ADDR(*)
17    INTEGER(KIND=MPI_ADDRESS_KIND) TARGET_DISP
18    INTEGER ORIGIN_COUNT, ORIGIN_DATATYPE, TARGET_RANK, TARGET_COUNT,
19    TARGET_DATATYPE, OP, WIN, REQUEST, IERROR
20
21    MPI_RGET_ACCUMULATE(ORIGIN_ADDR, ORIGIN_COUNT, ORIGIN_DATATYPE,
22                       RESULT_ADDR, RESULT_COUNT, RESULT_DATATYPE, TARGET_RANK,
23                       TARGET_DISP, TARGET_COUNT, TARGET_DATATYPE, OP, WIN, REQUEST,
24                       IERROR)
25    <type> ORIGIN_ADDR(*), RESULT_ADDR(*)
26    INTEGER(KIND=MPI_ADDRESS_KIND) TARGET_DISP
27    INTEGER ORIGIN_COUNT, ORIGIN_DATATYPE, RESULT_COUNT, RESULT_DATATYPE,
28    TARGET_RANK, TARGET_COUNT, TARGET_DATATYPE, OP, WIN, REQUEST, IERROR
29
30    MPI_RGET(ORIGIN_ADDR, ORIGIN_COUNT, ORIGIN_DATATYPE, TARGET_RANK,
31             TARGET_DISP, TARGET_COUNT, TARGET_DATATYPE, WIN, REQUEST,
32             IERROR)
33    <type> ORIGIN_ADDR(*)
34    INTEGER(KIND=MPI_ADDRESS_KIND) TARGET_DISP
35    INTEGER ORIGIN_COUNT, ORIGIN_DATATYPE, TARGET_RANK, TARGET_COUNT,
36    TARGET_DATATYPE, WIN, REQUEST, IERROR
37
38    MPI_RPUT(ORIGIN_ADDR, ORIGIN_COUNT, ORIGIN_DATATYPE, TARGET_RANK,
39            TARGET_DISP, TARGET_COUNT, TARGET_DATATYPE, WIN, REQUEST,
40            IERROR)
41    <type> ORIGIN_ADDR(*)
42    INTEGER(KIND=MPI_ADDRESS_KIND) TARGET_DISP
43    INTEGER ORIGIN_COUNT, ORIGIN_DATATYPE, TARGET_RANK, TARGET_COUNT,
44    TARGET_DATATYPE, WIN, REQUEST, IERROR
45
46    MPI_WIN_ALLOCATE_SHARED(SIZE, INFO, COMM, BASEPTR, WIN, IERROR)
47    INTEGER INFO, COMM, WIN, IERROR
48    INTEGER(KIND=MPI_ADDRESS_KIND) SIZE, BASEPTR
49
50    MPI_WIN_ALLOCATE(SIZE, DISP_UNIT, INFO, COMM, BASEPTR, WIN, IERROR)
51    INTEGER DISP_UNIT, INFO, COMM, WIN, IERROR

```

```

    INTEGER(KIND=MPI_ADDRESS_KIND) SIZE, BASEPTR
1
MPI_WIN_ATTACH(WIN, BASE, SIZE, IERROR)
2
    INTEGER WIN, IERROR
3
    <type> [base]BASE(*)
4 ticketxx:12/9
    INTEGER (KIND=MPI_ADDRESS_[SIZE]KIND) [size]SIZE
5 ticketxx:8/16
6
MPI_WIN_COMPLETE(WIN, IERROR)
7 ticketxx:12/9
    INTEGER WIN, IERROR
8
9
MPI_WIN_CREATE(BASE, SIZE, DISP_UNIT, INFO, COMM, WIN, IERROR)
10
    <type> BASE(*)
11
    INTEGER(KIND=MPI_ADDRESS_KIND) SIZE
12
    INTEGER DISP_UNIT, INFO, COMM, WIN, IERROR
13
14
MPI_WIN_CREATE_DYNAMIC(INFO, COMM, WIN, IERROR)
15
    INTEGER INFO, COMM, WIN, IERROR
16
17
MPI_WIN_DETACH(WIN, BASE, IERROR)
18
    INTEGER WIN, IERROR
19 ticketxx:12/9
    <type> [base]BASE(*)
20
21
MPI_WIN_FENCE(ASSERT, WIN, IERROR)
22
    INTEGER ASSERT, WIN, IERROR
23
24
MPI_WIN_FLUSH_ALL(WIN, IERROR)
25
    INTEGER WIN, IERROR
26
27
MPI_WIN_FLUSH_LOCAL_ALL(WIN, IERROR)
28
    INTEGER WIN, IERROR
29
30
MPI_WIN_FLUSH_LOCAL(RANK, WIN, IERROR)
31
    INTEGER RANK, WIN, IERROR
32
33
MPI_WIN_FLUSH(RANK, WIN, IERROR)
34
    INTEGER RANK, WIN, IERROR
35
36
MPI_WIN_FREE(WIN, IERROR)
37
    INTEGER WIN, IERROR
38
39
MPI_WIN_GET_GROUP(WIN, GROUP, IERROR)
40
    INTEGER WIN, GROUP, IERROR
41
42
MPI_WIN_LOCK_ALL(ASSERT, WIN, IERROR)
43
    INTEGER ASSERT, WIN, IERROR
44
45
MPI_WIN_LOCK(LOCK_TYPE, RANK, ASSERT, WIN, IERROR)
46
    INTEGER LOCK_TYPE, RANK, ASSERT, WIN, IERROR
47
48
MPI_WIN_POST(GROUP, ASSERT, WIN, IERROR)
49
    INTEGER GROUP, ASSERT, WIN, IERROR
50
51
MPI_WIN_SHARED_QUERY(WIN, RANK, SIZE, BASEPTR, IERROR)
52
    INTEGER WIN, RANK, IERROR
53
    INTEGER (KIND=MPI_ADDRESS_KIND) SIZE, BASEPTR
54

```

```
1 MPI_WIN_START(GROUP, ASSERT, WIN, IERROR)
2     INTEGER GROUP, ASSERT, WIN, IERROR
3
4 MPI_WIN_SYNC(WIN, IERROR)
5     INTEGER WIN, IERROR
6
7 MPI_WIN_TEST(WIN, FLAG, IERROR)
8     INTEGER WIN, IERROR
9     LOGICAL FLAG
10
11 MPI_WIN_UNLOCK_ALL(WIN, IERROR)
12     INTEGER WIN, IERROR
13
14 MPI_WIN_UNLOCK(RANK, WIN, IERROR)
15     INTEGER RANK, WIN, IERROR
16
17 MPI_WIN_WAIT(WIN, IERROR)
18     INTEGER WIN, IERROR
19
20 A.4.10 External Interfaces Fortran Bindings
21
22 MPI_GREQUEST_COMPLETE(REQUEST, IERROR)
23     INTEGER REQUEST, IERROR
24
25 MPI_GREQUEST_START(QUERY_FN, FREE_FN, CANCEL_FN, EXTRA_STATE, REQUEST,
26     IERROR)
27     INTEGER REQUEST, IERROR
28     EXTERNAL QUERY_FN, FREE_FN, CANCEL_FN
29     INTEGER (KIND=MPI_ADDRESS_KIND) EXTRA_STATE
30
31 MPI_INIT_THREAD(REQUIRED, PROVIDED, IERROR)
32     INTEGER REQUIRED, PROVIDED, IERROR
33
34 MPI_IS_THREAD_MAIN(FLAG, IERROR)
35     LOGICAL FLAG
36     INTEGER IERROR
37
38 MPI_QUERY_THREAD(PROVIDED, IERROR)
39     INTEGER PROVIDED, IERROR
40
41 MPI_STATUS_SET_CANCELLED(STATUS, FLAG, IERROR)
42     INTEGER STATUS(MPI_STATUS_SIZE), IERROR
43     LOGICAL FLAG
44
45 MPI_STATUS_SET_ELEMENTS(STATUS, DATATYPE, COUNT, IERROR)
46     INTEGER STATUS(MPI_STATUS_SIZE), DATATYPE, COUNT, IERROR
47
48 MPI_STATUS_SET_ELEMENTS_X(STATUS, DATATYPE, COUNT, IERROR)
49     INTEGER STATUS(MPI_STATUS_SIZE), DATATYPE, IERROR
50     INTEGER (KIND=MPI_COUNT_KIND) COUNT
```

A.4.11 I/O Fortran Bindings

	1
	2
MPI_FILE_CLOSE(FH, IERROR)	3
INTEGER FH, IERROR	4
	5
MPI_FILE_DELETE(FILENAME, INFO, IERROR)	6
CHARACTER*(*) FILENAME	7
INTEGER INFO, IERROR	8
	9
MPI_FILE_GET_AMODE(FH, AMODE, IERROR)	10
INTEGER FH, AMODE, IERROR	11
	12
MPI_FILE_GET_ATOMICITY(FH, FLAG, IERROR)	13
INTEGER FH, IERROR	14
LOGICAL FLAG	15
	16
MPI_FILE_GET_BYTE_OFFSET(FH, OFFSET, DISP, IERROR)	17
INTEGER FH, IERROR	18
INTEGER(KIND=MPI_OFFSET_KIND) OFFSET, DISP	19
	20
MPI_FILE_GET_GROUP(FH, GROUP, IERROR)	21
INTEGER FH, GROUP, IERROR	22
	23
MPI_FILE_GET_INFO(FH, INFO_USED, IERROR)	24
INTEGER FH, INFO_USED, IERROR	25
	26
MPI_FILE_GET_POSITION(FH, OFFSET, IERROR)	27
INTEGER FH, IERROR	28
INTEGER(KIND=MPI_OFFSET_KIND) OFFSET	29
	30
MPI_FILE_GET_POSITION_SHARED(FH, OFFSET, IERROR)	31
INTEGER FH, IERROR	32
INTEGER(KIND=MPI_OFFSET_KIND) OFFSET	33
	34
MPI_FILE_GET_SIZE(FH, SIZE, IERROR)	35
INTEGER FH, IERROR	36
INTEGER(KIND=MPI_OFFSET_KIND) SIZE	37
	38
MPI_FILE_GET_TYPE_EXTENT(FH, DATATYPE, EXTENT, IERROR)	39
INTEGER FH, DATATYPE, IERROR	40
INTEGER(KIND=MPI_ADDRESS_KIND) EXTENT	41
	42
MPI_FILE_GET_VIEW(FH, DISP, ETYPE, FILETYPE, DATAREP, IERROR)	43
INTEGER FH, ETYPE, FILETYPE, IERROR	44
CHARACTER*(*) DATAREP	45
INTEGER(KIND=MPI_OFFSET_KIND) DISP	46
	47
MPI_FILE_IREAD_AT(FH, OFFSET, BUF, COUNT, DATATYPE, REQUEST, IERROR)	48
<type> BUF(*)	
INTEGER FH, COUNT, DATATYPE, REQUEST, IERROR	
INTEGER(KIND=MPI_OFFSET_KIND) OFFSET	
MPI_FILE_IREAD(FH, BUF, COUNT, DATATYPE, REQUEST, IERROR)	
<type> BUF(*)	

```
1     INTEGER FH, COUNT, DATATYPE, REQUEST, IERROR
2
3     MPI_FILE_IREAD_SHARED(FH, BUF, COUNT, DATATYPE, REQUEST, IERROR)
4     <type> BUF(*)
5     INTEGER FH, COUNT, DATATYPE, REQUEST, IERROR
6
7     MPI_FILE_IWRITE_AT(FH, OFFSET, BUF, COUNT, DATATYPE, REQUEST, IERROR)
8     <type> BUF(*)
9     INTEGER FH, COUNT, DATATYPE, REQUEST, IERROR
10    INTEGER(KIND=MPI_OFFSET_KIND) OFFSET
11
12    MPI_FILE_IWRITE(FH, BUF, COUNT, DATATYPE, REQUEST, IERROR)
13    <type> BUF(*)
14    INTEGER FH, COUNT, DATATYPE, REQUEST, IERROR
15
16    MPI_FILE_IWRITE_SHARED(FH, BUF, COUNT, DATATYPE, REQUEST, IERROR)
17    <type> BUF(*)
18    INTEGER FH, COUNT, DATATYPE, REQUEST, IERROR
19
20    MPI_FILE_OPEN(COMM, FILENAME, AMODE, INFO, FH, IERROR)
21    CHARACTER*(*) FILENAME
22    INTEGER COMM, AMODE, INFO, FH, IERROR
23
24    MPI_FILE_PREALLOCATE(FH, SIZE, IERROR)
25    INTEGER FH, IERROR
26    INTEGER(KIND=MPI_OFFSET_KIND) SIZE
27
28    MPI_FILE_READ_ALL_BEGIN(FH, BUF, COUNT, DATATYPE, IERROR)
29    <type> BUF(*)
30    INTEGER FH, COUNT, DATATYPE, IERROR
31
32    MPI_FILE_READ_ALL_END(FH, BUF, STATUS, IERROR)
33    <type> BUF(*)
34    INTEGER FH, STATUS(MPI_STATUS_SIZE), IERROR
35
36    MPI_FILE_READ_ALL(FH, BUF, COUNT, DATATYPE, STATUS, IERROR)
37    <type> BUF(*)
38    INTEGER FH, COUNT, DATATYPE, STATUS(MPI_STATUS_SIZE), IERROR
39
40    MPI_FILE_READ_AT_ALL_BEGIN(FH, OFFSET, BUF, COUNT, DATATYPE, IERROR)
41    <type> BUF(*)
42    INTEGER FH, COUNT, DATATYPE, IERROR
43    INTEGER(KIND=MPI_OFFSET_KIND) OFFSET
44
45    MPI_FILE_READ_AT_ALL_END(FH, BUF, STATUS, IERROR)
46    <type> BUF(*)
47    INTEGER FH, STATUS(MPI_STATUS_SIZE), IERROR
48
49    MPI_FILE_READ_AT_ALL(FH, OFFSET, BUF, COUNT, DATATYPE, STATUS, IERROR)
50    <type> BUF(*)
51    INTEGER FH, COUNT, DATATYPE, STATUS(MPI_STATUS_SIZE), IERROR
52    INTEGER(KIND=MPI_OFFSET_KIND) OFFSET
53
54    MPI_FILE_READ_AT(FH, OFFSET, BUF, COUNT, DATATYPE, STATUS, IERROR)
```



```

    <type> BUF(*) 1
    INTEGER FH, COUNT, DATATYPE, STATUS(MPI_STATUS_SIZE), IERROR 2
    INTEGER(KIND=MPI_OFFSET_KIND) OFFSET 3
MPI_FILE_READ(FH, BUF, COUNT, DATATYPE, STATUS, IERROR) 4
    <type> BUF(*) 5
    INTEGER FH, COUNT, DATATYPE, STATUS(MPI_STATUS_SIZE), IERROR 6
MPI_FILE_READ_ORDERED_BEGIN(FH, BUF, COUNT, DATATYPE, IERROR) 8
    <type> BUF(*) 9
    INTEGER FH, COUNT, DATATYPE, IERROR 10
MPI_FILE_READ_ORDERED_END(FH, BUF, STATUS, IERROR) 11
    <type> BUF(*) 12
    INTEGER FH, STATUS(MPI_STATUS_SIZE), IERROR 13
MPI_FILE_READ_ORDERED(FH, BUF, COUNT, DATATYPE, STATUS, IERROR) 15
    <type> BUF(*) 16
    INTEGER FH, COUNT, DATATYPE, STATUS(MPI_STATUS_SIZE), IERROR 17
MPI_FILE_READ_SHARED(FH, BUF, COUNT, DATATYPE, STATUS, IERROR) 18
    <type> BUF(*) 19
    INTEGER FH, COUNT, DATATYPE, STATUS(MPI_STATUS_SIZE), IERROR 20
MPI_FILE_SEEK(FH, OFFSET, WHENCE, IERROR) 22
    INTEGER FH, WHENCE, IERROR 23
    INTEGER(KIND=MPI_OFFSET_KIND) OFFSET 24
MPI_FILE_SEEK_SHARED(FH, OFFSET, WHENCE, IERROR) 26
    INTEGER FH, WHENCE, IERROR 27
    INTEGER(KIND=MPI_OFFSET_KIND) OFFSET 28
MPI_FILE_SET_ATOMICITY(FH, FLAG, IERROR) 29
    INTEGER FH, IERROR 30
    LOGICAL FLAG 31
MPI_FILE_SET_INFO(FH, INFO, IERROR) 32
    INTEGER FH, INFO, IERROR 33
MPI_FILE_SET_SIZE(FH, SIZE, IERROR) 35
    INTEGER FH, IERROR 36
    INTEGER(KIND=MPI_OFFSET_KIND) SIZE 37
MPI_FILE_SET_VIEW(FH, DISP, ETYPE, FILETYPE, DATAREP, INFO, IERROR) 38
    INTEGER FH, ETYPE, FILETYPE, INFO, IERROR 39
    CHARACTER*(*) DATAREP 40
    INTEGER(KIND=MPI_OFFSET_KIND) DISP 41
MPI_FILE_SYNC(FH, IERROR) 42
    INTEGER FH, IERROR 43
MPI_FILE_WRITE_ALL_BEGIN(FH, BUF, COUNT, DATATYPE, IERROR) 44
    <type> BUF(*) 45
    INTEGER FH, COUNT, DATATYPE, IERROR 46

```

```

1 MPI_FILE_WRITE_ALL_END(FH, BUF, STATUS, IERROR)
2   <type> BUF(*)
3   INTEGER FH, STATUS(MPI_STATUS_SIZE), IERROR
4
5 MPI_FILE_WRITE_ALL(FH, BUF, COUNT, DATATYPE, STATUS, IERROR)
6   <type> BUF(*)
7   INTEGER FH, COUNT, DATATYPE, STATUS(MPI_STATUS_SIZE), IERROR
8
9 MPI_FILE_WRITE_AT_ALL_BEGIN(FH, OFFSET, BUF, COUNT, DATATYPE, IERROR)
10  <type> BUF(*)
11  INTEGER FH, COUNT, DATATYPE, IERROR
12  INTEGER(KIND=MPI_OFFSET_KIND) OFFSET
13
14 MPI_FILE_WRITE_AT_ALL_END(FH, BUF, STATUS, IERROR)
15  <type> BUF(*)
16  INTEGER FH, STATUS(MPI_STATUS_SIZE), IERROR
17
18 MPI_FILE_WRITE_AT_ALL(FH, OFFSET, BUF, COUNT, DATATYPE, STATUS, IERROR)
19  <type> BUF(*)
20  INTEGER FH, COUNT, DATATYPE, STATUS(MPI_STATUS_SIZE), IERROR
21  INTEGER(KIND=MPI_OFFSET_KIND) OFFSET
22
23 MPI_FILE_WRITE_AT(FH, OFFSET, BUF, COUNT, DATATYPE, STATUS, IERROR)
24  <type> BUF(*)
25  INTEGER FH, COUNT, DATATYPE, STATUS(MPI_STATUS_SIZE), IERROR
26  INTEGER(KIND=MPI_OFFSET_KIND) OFFSET
27
28 MPI_FILE_WRITE(FH, BUF, COUNT, DATATYPE, STATUS, IERROR)
29  <type> BUF(*)
30  INTEGER FH, COUNT, DATATYPE, STATUS(MPI_STATUS_SIZE), IERROR
31
32 MPI_FILE_WRITE_ORDERED_BEGIN(FH, BUF, COUNT, DATATYPE, IERROR)
33  <type> BUF(*)
34  INTEGER FH, COUNT, DATATYPE, IERROR
35
36 MPI_FILE_WRITE_ORDERED_END(FH, BUF, STATUS, IERROR)
37  <type> BUF(*)
38  INTEGER FH, STATUS(MPI_STATUS_SIZE), IERROR
39
40 MPI_FILE_WRITE_ORDERED(FH, BUF, COUNT, DATATYPE, STATUS, IERROR)
41  <type> BUF(*)
42  INTEGER FH, COUNT, DATATYPE, STATUS(MPI_STATUS_SIZE), IERROR
43
44 MPI_FILE_WRITE_SHARED(FH, BUF, COUNT, DATATYPE, STATUS, IERROR)
45  <type> BUF(*)
46  INTEGER FH, COUNT, DATATYPE, STATUS(MPI_STATUS_SIZE), IERROR
47
48 MPI_REGISTER_DATAREP(DATAREP, READ_CONVERSION_FN, WRITE_CONVERSION_FN,
49   DTYPE_FILE_EXTENT_FN, EXTRA_STATE, IERROR)
50  CHARACTER*(*) DATAREP
51  EXTERNAL READ_CONVERSION_FN, WRITE_CONVERSION_FN, DTYPE_FILE_EXTENT_FN
52  INTEGER(KIND=MPI_ADDRESS_KIND) EXTRA_STATE
53  INTEGER IERROR

```

A.4.12 Language Bindings Fortran Bindings

```
MPI_F_SYNC_REG(buf)
```

```
  <type> buf(*)
```

```
MPI_SIZEOF(X, SIZE, IERROR)
```

```
  <type> X
```

```
  INTEGER SIZE, IERROR
```

```
MPI_STATUS_F082F(F08_STATUS, F_STATUS, IERROR)
```

```
  TYPE(MPI_Status) :: F08_STATUS
```

```
  INTEGER :: F_STATUS(MPI_STATUS_SIZE)
```

```
  INTEGER IERROR
```

```
MPI_STATUS_F2F08(F_STATUS, F08_STATUS, IERROR)
```

```
  INTEGER :: F_STATUS(MPI_STATUS_SIZE)
```

```
  TYPE(MPI_Status) :: F08_STATUS
```

```
  INTEGER IERROR
```

```
MPI_TYPE_CREATE_F90_COMPLEX(P, R, NEWTYPE, IERROR)
```

```
  INTEGER P, R, NEWTYPE, IERROR
```

```
MPI_TYPE_CREATE_F90_INTEGER(R, NEWTYPE, IERROR)
```

```
  INTEGER R, NEWTYPE, IERROR
```

```
MPI_TYPE_CREATE_F90_REAL(P, R, NEWTYPE, IERROR)
```

```
  INTEGER P, R, NEWTYPE, IERROR
```

```
MPI_TYPE_MATCH_SIZE(TYPECLASS, SIZE, DATATYPE, IERROR)
```

```
  INTEGER TYPECLASS, SIZE, DATATYPE, IERROR
```

A.4.13 Profiling Interface Fortran Bindings

```
MPI_PCONTROL(LEVEL)
```

```
  INTEGER LEVEL
```

A.4.14 Deprecated Fortran Bindings

```
MPI_ADDRESS(LOCATION, ADDRESS, IERROR)
```

```
  <type> LOCATION(*)
```

```
  INTEGER ADDRESS, IERROR
```

```
MPI_ATTR_DELETE(COMM, KEYVAL, IERROR)
```

```
  INTEGER COMM, KEYVAL, IERROR
```

```
MPI_ATTR_GET(COMM, KEYVAL, ATTRIBUTE_VAL, FLAG, IERROR)
```

```
  INTEGER COMM, KEYVAL, ATTRIBUTE_VAL, IERROR
```

```
  LOGICAL FLAG
```

```
MPI_ATTR_PUT(COMM, KEYVAL, ATTRIBUTE_VAL, IERROR)
```

```
  INTEGER COMM, KEYVAL, ATTRIBUTE_VAL, IERROR
```

```

1 MPI_DUP_FN(OLDCOMM, KEYVAL, EXTRA_STATE, ATTRIBUTE_VAL_IN,
2           ATTRIBUTE_VAL_OUT, FLAG, IERR)
3     INTEGER OLDCOMM, KEYVAL, EXTRA_STATE, ATTRIBUTE_VAL_IN,
4     ATTRIBUTE_VAL_OUT, IERR
5     LOGICAL FLAG
6
7 MPI_ERRHANDLER_CREATE([FUNCTION]HANDLER_FN, ERRHANDLER, IERROR)
8     EXTERNAL [FUNCTION]HANDLER_FN
9     INTEGER ERRHANDLER, IERROR
10
11 MPI_ERRHANDLER_GET(COMM, ERRHANDLER, IERROR)
12     INTEGER COMM, ERRHANDLER, IERROR
13
14 MPI_ERRHANDLER_SET(COMM, ERRHANDLER, IERROR)
15     INTEGER COMM, ERRHANDLER, IERROR
16
17 MPI_KEYVAL_CREATE(COPY_FN, DELETE_FN, KEYVAL, EXTRA_STATE, IERROR)
18     EXTERNAL COPY_FN, DELETE_FN
19     INTEGER KEYVAL, EXTRA_STATE, IERROR
20
21 MPI_KEYVAL_FREE(KEYVAL, IERROR)
22     INTEGER KEYVAL, IERROR
23
24 MPI_NULL_COPY_FN(OLDCOMM, KEYVAL, EXTRA_STATE, ATTRIBUTE_VAL_IN,
25                 ATTRIBUTE_VAL_OUT, FLAG, IERR)
26     INTEGER OLDCOMM, KEYVAL, EXTRA_STATE, ATTRIBUTE_VAL_IN,
27     ATTRIBUTE_VAL_OUT, IERR
28     LOGICAL FLAG
29
30 MPI_NULL_DELETE_FN(COMM, KEYVAL, ATTRIBUTE_VAL, EXTRA_STATE, IERROR)
31     INTEGER COMM, KEYVAL, ATTRIBUTE_VAL, EXTRA_STATE, IERROR
32
33 MPI_TYPE_EXTENT(DATATYPE, EXTENT, IERROR)
34     INTEGER DATATYPE, EXTENT, IERROR
35
36 MPI_TYPE_HINDEXED(COUNT, ARRAY_OF_BLOCKLENGTHS, ARRAY_OF_DISPLACEMENTS,
37                 OLDTYPE, NEWTYPE, IERROR)
38     INTEGER COUNT, ARRAY_OF_BLOCKLENGTHS(*), ARRAY_OF_DISPLACEMENTS(*),
39     OLDTYPE, NEWTYPE, IERROR
40
41 MPI_TYPE_HVECTOR(COUNT, BLOCKLENGTH, STRIDE, OLDTYPE, NEWTYPE, IERROR)
42     INTEGER COUNT, BLOCKLENGTH, STRIDE, OLDTYPE, NEWTYPE, IERROR
43
44 MPI_TYPE_LB( DATATYPE, DISPLACEMENT, IERROR)
45     INTEGER DATATYPE, DISPLACEMENT, IERROR
46
47 MPI_TYPE_STRUCT(COUNT, ARRAY_OF_BLOCKLENGTHS, ARRAY_OF_DISPLACEMENTS,
48                 ARRAY_OF_TYPES, NEWTYPE, IERROR)
49     INTEGER COUNT, ARRAY_OF_BLOCKLENGTHS(*), ARRAY_OF_DISPLACEMENTS(*),
50     ARRAY_OF_TYPES(*), NEWTYPE, IERROR
51
52 MPI_TYPE_UB( DATATYPE, DISPLACEMENT, IERROR)
53     INTEGER DATATYPE, DISPLACEMENT, IERROR

```

```
SUBROUTINE COPY_FUNCTION(OLDCOMM, KEYVAL, EXTRA_STATE, ATTRIBUTE_VAL_IN, 1
    ATTRIBUTE_VAL_OUT, FLAG, IERR) 2
    INTEGER OLDCOMM, KEYVAL, EXTRA_STATE, ATTRIBUTE_VAL_IN, 3
    ATTRIBUTE_VAL_OUT, IERR 4
    LOGICAL FLAG 5
6
SUBROUTINE DELETE_FUNCTION(COMM, KEYVAL, ATTRIBUTE_VAL, EXTRA_STATE, IERR) 6
    INTEGER COMM, KEYVAL, ATTRIBUTE_VAL, EXTRA_STATE, IERR 7
8
9
10
11
12
13
14
15
16
17
18
19
20
21
22
23
24
25
26
27
28
29
30
31
32
33
34
35
36
37
38
39
40
41
42
43
44
45
46
47
48
```

1 A.5 C++ Bindings (deprecated)

3 A.5.1 Point-to-Point Communication C++ Bindings

```

4 namespace MPI {
5
6     {void Attach_buffer(void* buffer, int size) (binding deprecated, see
7         Section 15.2) }
8
9     {void Comm::Bsend(const void* buf, int count, const Datatype& datatype,
10         int dest, int tag) const (binding deprecated, see Section 15.2) }
11
12     {Prequest Comm::Bsend_init(const void* buf, int count, const
13         Datatype& datatype, int dest, int tag) const (binding deprecated,
14         see Section 15.2) }
15
16     {void Request::Cancel() const (binding deprecated, see Section 15.2) }
17
18     {int Detach_buffer(void*& buffer) (binding deprecated, see Section 15.2) }
19
20     {void Request::Free() (binding deprecated, see Section 15.2) }
21
22     {int Status::Get_count(const Datatype& datatype) const (binding deprecated,
23         see Section 15.2) }
24
25     {int Status::Get_error() const (binding deprecated, see Section 15.2) }
26
27     {int Status::Get_source() const (binding deprecated, see Section 15.2) }
28
29     {bool Request::Get_status() const (binding deprecated, see Section 15.2) }
30
31     {bool Request::Get_status(Status& status) const (binding deprecated, see
32         Section 15.2) }
33
34     {int Status::Get_tag() const (binding deprecated, see Section 15.2) }
35
36     {Request Comm::Ibsend(const void* buf, int count, const
37         Datatype& datatype, int dest, int tag) const (binding deprecated,
38         see Section 15.2) }
39
40     {bool Comm::Iprobe(int source, int tag) const (binding deprecated, see
41         Section 15.2) }
42
43     {bool Comm::Iprobe(int source, int tag, Status& status) const (binding
44         deprecated, see Section 15.2) }
45
46     {Request Comm::Irecv(void* buf, int count, const Datatype& datatype,
47         int source, int tag) const (binding deprecated, see Section 15.2) }
48
49     {Request Comm::Irsend(const void* buf, int count, const
50         Datatype& datatype, int dest, int tag) const (binding deprecated,
51         see Section 15.2) }
52
53     {bool Status::Is_cancelled() const (binding deprecated, see Section 15.2) }
54
55     {Request Comm::Isend(const void* buf, int count, const
56         Datatype& datatype, int dest, int tag) const (binding deprecated,
57         see Section 15.2) }

```

```

    see Section 15.2) }
1
2
3 {Request Comm::Issend(const void* buf, int count, const
4     Datatype& datatype, int dest, int tag) const(binding deprecated,
5     see Section 15.2) }
6
7 {void Comm::Probe(int source, int tag) const(binding deprecated, see
8     Section 15.2) }
9
10 {void Comm::Probe(int source, int tag, Status& status) const(binding
11     deprecated, see Section 15.2) }
12
13 {Prequest Comm::Recv_init(void* buf, int count, const Datatype& datatype,
14     int source, int tag) const(binding deprecated, see Section 15.2) }
15
16 {void Comm::Recv(void* buf, int count, const Datatype& datatype,
17     int source, int tag) const(binding deprecated, see Section 15.2) }
18
19 {void Comm::Recv(void* buf, int count, const Datatype& datatype,
20     int source, int tag, Status& status) const(binding deprecated, see
21     Section 15.2) }
22
23 {void Comm::Rsend(const void* buf, int count, const Datatype& datatype,
24     int dest, int tag) const(binding deprecated, see Section 15.2) }
25
26 {Prequest Comm::Rsend_init(const void* buf, int count, const
27     Datatype& datatype, int dest, int tag) const(binding deprecated,
28     see Section 15.2) }
29
30 {void Comm::Send(const void* buf, int count, const Datatype& datatype,
31     int dest, int tag) const(binding deprecated, see Section 15.2) }
32
33 {Prequest Comm::Send_init(const void* buf, int count, const
34     Datatype& datatype, int dest, int tag) const(binding deprecated,
35     see Section 15.2) }
36
37 {void Comm::Sendrecv(const void *sendbuf, int sendcount, const
38     Datatype& sendtype, int dest, int sendtag, void *recvbuf,
39     int recvcount, const Datatype& recvtype, int source,
40     int recvtag) const(binding deprecated, see Section 15.2) }
41
42 {void Comm::Sendrecv(const void *sendbuf, int sendcount, const
43     Datatype& sendtype, int dest, int sendtag, void *recvbuf,
44     int recvcount, const Datatype& recvtype, int source,
45     int recvtag, Status& status) const(binding deprecated, see
46     Section 15.2) }
47
48 {void Comm::Sendrecv_replace(void* buf, int count, const
49     Datatype& datatype, int dest, int sendtag, int source,
50     int recvtag) const(binding deprecated, see Section 15.2) }
51
52 {void Comm::Sendrecv_replace(void* buf, int count, const
53     Datatype& datatype, int dest, int sendtag, int source,
54     int recvtag, Status& status) const(binding deprecated, see
55     Section 15.2) }

```

```

1         Section 15.2 }
2
3     {void Status::Set_error(int error) (binding deprecated, see Section 15.2) }
4
5     {void Status::Set_source(int source) (binding deprecated, see Section 15.2) }
6
7     {void Status::Set_tag(int tag) (binding deprecated, see Section 15.2) }
8
9     {void Comm::Ssend(const void* buf, int count, const Datatype& datatype,
10        int dest, int tag) const (binding deprecated, see Section 15.2) }
11
12     {Prequest Comm::Ssend_init(const void* buf, int count, const
13        Datatype& datatype, int dest, int tag) const (binding deprecated,
14        see Section 15.2) }
15
16     {static void Prequest::Startall(int count,
17        Prequest array_of_requests[]) (binding deprecated, see Section 15.2) }
18
19     {void Prequest::Start() (binding deprecated, see Section 15.2) }
20
21     {static bool Request::Testall(int count, Request array_of_requests[],
22        Status array_of_statuses[]) (binding deprecated, see Section 15.2) }
23
24     {static bool Request::Testall(int count,
25        Request array_of_requests[]) (binding deprecated, see Section 15.2) }
26
27     {static bool Request::Testany(int count, Request array_of_requests[],
28        int& index, Status& status) (binding deprecated, see Section 15.2) }
29
30     {static bool Request::Testany(int count, Request array_of_requests[],
31        int& index) (binding deprecated, see Section 15.2) }
32
33     {bool Request::Test() (binding deprecated, see Section 15.2) }
34
35     {bool Request::Test(Status& status) (binding deprecated, see Section 15.2) }
36
37     {static int Request::Testsome(int incount, Request array_of_requests[],
38        int array_of_indices[], Status array_of_statuses[]) (binding
39        deprecated, see Section 15.2) }
40
41     {static int Request::Testsome(int incount, Request array_of_requests[],
42        int array_of_indices[]) (binding deprecated, see Section 15.2) }
43
44     {static void Request::Waitall(int count, Request array_of_requests[],
45        Status array_of_statuses[]) (binding deprecated, see Section 15.2) }
46
47     {static void Request::Waitall(int count,
48        Request array_of_requests[]) (binding deprecated, see Section 15.2) }
49
50     {static int Request::Waitany(int count, Request array_of_requests[],
51        Status& status) (binding deprecated, see Section 15.2) }
52
53     {static int Request::Waitany(int count,
54        Request array_of_requests[]) (binding deprecated, see Section 15.2) }
55
56     {void Request::Wait(Status& status) (binding deprecated, see Section 15.2) }

```



```

{static int Request::WaitSome(int incount, Request array_of_requests[],
    int array_of_indices[], Status array_of_statuses[]) (binding
    deprecated, see Section 15.2) }
}
};

```

A.5.2 Datatypes C++ Bindings

```

namespace MPI {
    {void Datatype::Commit() (binding deprecated, see Section 15.2) }
    {Datatype Datatype::Create_contiguous(int count) const (binding deprecated,
        see Section 15.2) }
    {Datatype Datatype::Create_darray(int size, int rank, int ndims,
        const int array_of_gsizes[], const int array_of_distrib[],
        const int array_of_dargs[], const int array_of_psizes[],
        int order) const (binding deprecated, see Section 15.2) }
    {Datatype Datatype::Create_hindexed(int count,
        const int array_of_blocklengths[],
        const Aint array_of_displacements[]) const (binding deprecated, see
        Section 15.2) }
    {Datatype Datatype::Create_hvector(int count, int blocklength, Aint
        stride) const (binding deprecated, see Section 15.2) }
    {Datatype Datatype::Create_indexed_block(int count, int blocklength,
        const int array_of_displacements[]) const (binding deprecated, see
        Section 15.2) }
    {Datatype Datatype::Create_indexed(int count,
        const int array_of_blocklengths[],
        const int array_of_displacements[]) const (binding deprecated, see
        Section 15.2) }
    {Datatype Datatype::Create_resized(const Aint lb, const Aint extent)
        const (binding deprecated, see Section 15.2) }
    {static Datatype Datatype::Create_struct(int count,
        const int array_of_blocklengths[], const Aint
        array_of_displacements[],
        const Datatype array_of_types[]) (binding deprecated, see
        Section 15.2) }
    {Datatype Datatype::Create_subarray(int ndims,
        const int array_of_sizes[], const int array_of_subsizes[],

```

```

1         const int array_of_starts[], int order) const(binding deprecated,
2         see Section 15.2) }
3
4     {Datatype Datatype::Create_vector(int count, int blocklength, int stride)
5         const(binding deprecated, see Section 15.2) }
6
7     {Datatype Datatype::Dup() const(binding deprecated, see Section 15.2) }
8
9     {void Datatype::Free() (binding deprecated, see Section 15.2) }
10
11    {Aint Get_address(void* location) (binding deprecated, see Section 15.2) }
12
13    {void Datatype::Get_contents(int max_integers, int max_addresses,
14        int max_datatypes, int array_of_integers[],
15        Aint array_of_addresses[], Datatype array_of_datatypes[])
16        const(binding deprecated, see Section 15.2) }
17
18    {int Status::Get_elements(const Datatype& datatype) const(binding deprecated,
19        see Section 15.2) }
20
21    {void Datatype::Get_envelope(int& num_integers, int& num_addresses,
22        int& num_datatypes, int& combiner) const(binding deprecated, see
23        Section 15.2) }
24
25    {void Datatype::Get_extent(Aint& lb, Aint& extent) const(binding deprecated,
26        see Section 15.2) }
27
28    {int Datatype::Get_size() const(binding deprecated, see Section 15.2) }
29
30    {void Datatype::Get_true_extent(Aint& true_lb, Aint& true_extent)
31        const(binding deprecated, see Section 15.2) }
32
33    {void Datatype::Pack(const void* inbuf, int incount, void *outbuf,
34        int outsize, int& position, const Comm &comm) const(binding
35        deprecated, see Section 15.2) }
36
37    {void Datatype::Pack_external(const char* datarep, const void* inbuf,
38        int incount, void* outbuf, Aint outsize, Aint& position)
39        const(binding deprecated, see Section 15.2) }
40
41    {Aint Datatype::Pack_external_size(const char* datarep, int incount)
42        const(binding deprecated, see Section 15.2) }
43
44    {int Datatype::Pack_size(int incount, const Comm& comm) const(binding
45        deprecated, see Section 15.2) }
46
47    {void Datatype::Unpack(const void* inbuf, int insize, void *outbuf,
48        int outcount, int& position, const Comm& comm) const(binding
49        deprecated, see Section 15.2) }
50
51    {void Datatype::Unpack_external(const char* datarep, const void* inbuf,
52        Aint insize, Aint& position, void* outbuf, int outcount) const
53        (binding deprecated, see Section 15.2) }
54
55 };

```

A.5.3 Collective Communication C++ Bindings

```

namespace MPI {
    {void Comm::Allgather(const void* sendbuf, int sendcount, const
        Datatype& sendtype, void* recvbuf, int recvcount,
        const Datatype& recvtype) const = 0(binding deprecated, see
        Section 15.2) }
    {void Comm::Allgatherv(const void* sendbuf, int sendcount, const
        Datatype& sendtype, void* recvbuf, const int recvcounts[],
        const int displs[], const Datatype& recvtype) const = 0(binding
        deprecated, see Section 15.2) }
    {void Comm::Allreduce(const void* sendbuf, void* recvbuf, int count,
        const Datatype& datatype, const Op& op) const = 0(binding
        deprecated, see Section 15.2) }
    {void Comm::Alltoall(const void* sendbuf, int sendcount, const
        Datatype& sendtype, void* recvbuf, int recvcount,
        const Datatype& recvtype) const = 0(binding deprecated, see
        Section 15.2) }
    {void Comm::Alltoallv(const void* sendbuf, const int sendcounts[],
        const int sdispls[], const Datatype& sendtype, void* recvbuf,
        const int recvcounts[], const int rdispls[],
        const Datatype& recvtype) const = 0(binding deprecated, see
        Section 15.2) }
    {void Comm::Alltoallw(const void* sendbuf, const int sendcounts[], const
        int sdispls[], const Datatype sendtypes[], void* recvbuf,
        const int recvcounts[], const int rdispls[], const Datatype
        recvtypes[]) const = 0(binding deprecated, see Section 15.2) }
    {void Comm::Barrier() const = 0(binding deprecated, see Section 15.2) }
    {void Comm::Bcast(void* buffer, int count, const Datatype& datatype,
        int root) const = 0(binding deprecated, see Section 15.2) }
    {void Intracomm::Exscan(const void* sendbuf, void* recvbuf, int count,
        const Datatype& datatype, const Op& op) const(binding deprecated,
        see Section 15.2) }
    {void Op::Free() (binding deprecated, see Section 15.2) }
    {void Comm::Gather(const void* sendbuf, int sendcount, const
        Datatype& sendtype, void* recvbuf, int recvcount,
        const Datatype& recvtype, int root) const = 0(binding deprecated,
        see Section 15.2) }
    {void Comm::Gatherv(const void* sendbuf, int sendcount, const
        Datatype& sendtype, void* recvbuf, const int recvcounts[],
        const int displs[], const Datatype& recvtype, int root)
        const = 0(binding deprecated, see Section 15.2) }

```

```

1  {Request Comm::Iallgather(const void* sendbuf, int sendcount, const
2      Datatype& sendtype, void* recvbuf, int recvcount,
3      const Datatype& recvtype) const = 0(binding deprecated, see
4      Section 15.2) }
5
6  {Request Comm::Iallgatherv(const void* sendbuf, int sendcount, const
7      Datatype& sendtype, void* recvbuf, const int recvcounts[],
8      const int displs[], const Datatype& recvtype) const = 0(binding
9      deprecated, see Section 15.2) }
10
11 {Request Comm::Iallreduce(const void* sendbuf, void* recvbuf, int count,
12     const Datatype& datatype, const Op& op) const = 0(binding
13     deprecated, see Section 15.2) }
14
15 {Request Comm::Ialltoall(const void* sendbuf, int sendcount, const
16     Datatype& sendtype, void* recvbuf, int recvcount,
17     const Datatype& recvtype) const = 0(binding deprecated, see
18     Section 15.2) }
19
20 {Request Comm::Ialltoallv(const void* sendbuf, const int sendcounts[],
21     const int sdispls[], const Datatype& sendtype, void* recvbuf,
22     const int recvcounts[], const int rdispls[],
23     const Datatype& recvtype) const = 0(binding deprecated, see
24     Section 15.2) }
25
26 {Request Comm::Ialltoallw(const void* sendbuf, const int sendcounts[],
27     const int sdispls[], const Datatype sendtypes[], void*
28     recvbuf, const int recvcounts[], const int rdispls[], const
29     Datatype recvtypes[]) const = 0(binding deprecated, see
30     Section 15.2) }
31
32 {Request Comm::Ibarrier() const = 0(binding deprecated, see Section 15.2) }
33
34 {Request Comm::Ibcast(void* buffer, int count, const Datatype& datatype,
35     int root) const = 0(binding deprecated, see Section 15.2) }
36
37 {Request Intracomm::Iexscan(const void* sendbuf, void* recvbuf, int
38     count, const Datatype& datatype, const Op& op) const(binding
39     deprecated, see Section 15.2) }
40
41 {Request Comm::Igather(const void* sendbuf, int sendcount, const
42     Datatype& sendtype, void* recvbuf, int recvcount,
43     const Datatype& recvtype, int root) const = 0(binding deprecated,
44     see Section 15.2) }
45
46 {Request Comm::Igatherv(const void* sendbuf, int sendcount, const
47     Datatype& sendtype, void* recvbuf, const int recvcounts[],
48     const int displs[], const Datatype& recvtype, int root)
49     const = 0(binding deprecated, see Section 15.2) }
50
51 {void Op::Init(User_function* [function]user_fn, bool commute)(binding
52     deprecated, see Section 15.2) }

```

```

{Request Comm::Ireduce(const void* sendbuf, void* recvbuf, int count,
    const Datatype& datatype, const Op& op, int root)
    const = 0(binding deprecated, see Section 15.2) }
{Request Comm::Ireduce_scatter_block(const void* sendbuf, void* recvbuf,
    int recvcnt, const Datatype& datatype, const Op& op)
    const = 0(binding deprecated, see Section 15.2) }
{Request Comm::Ireduce_scatter(const void* sendbuf, void* recvbuf,
    int recvcnts[], const Datatype& datatype, const Op& op)
    const = 0(binding deprecated, see Section 15.2) }
{Request Intracomm::Iscan(const void* sendbuf, void* recvbuf, int count,
    const Datatype& datatype, const Op& op) const(binding deprecated,
    see Section 15.2) }
{Request Comm::Iscatter(const void* sendbuf, int sendcount, const
    Datatype& sendtype, void* recvbuf, int recvcnt,
    const Datatype& recvtype, int root) const = 0(binding deprecated,
    see Section 15.2) }
{Request Comm::Iscatterv(const void* sendbuf, const int sendcounts[],
    const int displs[], const Datatype& sendtype, void* recvbuf,
    int recvcnt, const Datatype& recvtype, int root)
    const = 0(binding deprecated, see Section 15.2) }
{bool Op::Is_commutative() const(binding deprecated, see Section 15.2) }
{void Comm::Reduce(const void* sendbuf, void* recvbuf, int count,
    const Datatype& datatype, const Op& op, int root)
    const = 0(binding deprecated, see Section 15.2) }
{void Op::Reduce_local(const void* inbuf, void* inoutbuf, int count,
    const Datatype& datatype) const(binding deprecated, see
    Section 15.2) }
{void Comm::Reduce_scatter_block(const void* sendbuf, void* recvbuf,
    int recvcnt, const Datatype& datatype, const Op& op)
    const = 0(binding deprecated, see Section 15.2) }
{void Comm::Reduce_scatter(const void* sendbuf, void* recvbuf,
    int recvcnts[], const Datatype& datatype, const Op& op)
    const = 0(binding deprecated, see Section 15.2) }
{void Intracomm::Scan(const void* sendbuf, void* recvbuf, int count,
    const Datatype& datatype, const Op& op) const(binding deprecated,
    see Section 15.2) }
{void Comm::Scatter(const void* sendbuf, int sendcount, const
    Datatype& sendtype, void* recvbuf, int recvcnt,
    const Datatype& recvtype, int root) const = 0(binding deprecated,
    see Section 15.2) }

```

```

1   {void Comm::Scatterv(const void* sendbuf, const int sendcounts[],
2       const int displs[], const Datatype& sendtype, void* recvbuf,
3       int recvcnt, const Datatype& recvtype, int root)
4       const = 0(binding deprecated, see Section 15.2) }
5
6   };
7

```

A.5.4 Groups, Contexts, Communicators, and Caching C++ Bindings

```

9   namespace MPI {
10
11      {Comm& Comm::Clone() const = 0(binding deprecated, see Section 15.2) }
12
13      {Cartcomm& Cartcomm::Clone() const(binding deprecated, see Section 15.2) }
14
15      {Distgraphcomm& Distgraphcomm::Clone() const(binding deprecated, see
16          Section 15.2) }
17
18      {Graphcomm& Graphcomm::Clone() const(binding deprecated, see Section 15.2) }
19
20      {Intercomm& Intercomm::Clone() const(binding deprecated, see Section 15.2) }
21
22      {Intracomm& Intracomm::Clone() const(binding deprecated, see Section 15.2) }
23
24      {static int Comm::Compare(const Comm& comm1, const Comm& comm2)(binding
25          deprecated, see Section 15.2) }
26
27      {static int Group::Compare(const Group& group1,
28          const Group& group2)(binding deprecated, see Section 15.2) }
29
30      {Intercomm Intercomm::Create(const Group& group) const(binding deprecated,
31          see Section 15.2) }
32
33      {Intracomm Intracomm::Create(const Group& group) const(binding deprecated,
34          see Section 15.2) }
35
36      {Intercomm Intracomm::Create_intercomm(int local_leader, const
37          Comm& peer_comm, int remote_leader, int tag) const(binding
38          deprecated, see Section 15.2) }
39
40      {static int Comm::Create_keyval(Comm::Copy_attr_function*
41          comm_copy_attr_fn,
42          Comm::Delete_attr_function* comm_delete_attr_fn,
43          void* extra_state)(binding deprecated, see Section 15.2) }
44
45      {static int Datatype::Create_keyval(Datatype::Copy_attr_function*
46          type_copy_attr_fn, Datatype::Delete_attr_function*
47          type_delete_attr_fn, void* extra_state)(binding deprecated, see
48          Section 15.2) }
49
50      {static int Win::Create_keyval(Win::Copy_attr_function* win_copy_attr_fn,
51          Win::Delete_attr_function* win_delete_attr_fn,
52          void* extra_state)(binding deprecated, see Section 15.2) }
53
54      {void Comm::Delete_attr(int comm_keyval)(binding deprecated, see Section 15.2) }
55

```

```

{void Datatype::Delete_attr(int type_keyval) (binding deprecated, see           1
    Section 15.2) }                                                         2
                                                                              3
{void Win::Delete_attr(int win_keyval) (binding deprecated, see Section 15.2) } 4
                                                                              5
{static Group Group::Difference(const Group& group1,                          6
    const Group& group2) (binding deprecated, see Section 15.2) }           7
                                                                              8
{Cartcomm Cartcomm::Dup() const (binding deprecated, see Section 15.2) }     9
                                                                              10
{Distgraphcomm Distgraphcomm::Dup() const (binding deprecated, see Section 15.2) } 11
                                                                              12
{Graphcomm Graphcomm::Dup() const (binding deprecated, see Section 15.2) } 13
                                                                              14
{Intercomm Intercomm::Dup() const (binding deprecated, see Section 15.2) } 15
                                                                              16
{Intracomm Intracomm::Dup() const (binding deprecated, see Section 15.2) } 17
                                                                              18
{static void Comm::Free_keyval(int& comm_keyval) (binding deprecated, see     19
    Section 15.2) }                                                         20
                                                                              21
{static void Datatype::Free_keyval(int& type_keyval) (binding deprecated, see 22
    Section 15.2) }                                                         23
                                                                              24
{static void Win::Free_keyval(int& win_keyval) (binding deprecated, see      25
    Section 15.2) }                                                         26
                                                                              27
{void Comm::Free() (binding deprecated, see Section 15.2) }                28
                                                                              29
{void Group::Free() (binding deprecated, see Section 15.2) }               30
                                                                              31
{bool Comm::Get_attr(int comm_keyval, void* attribute_val) const (binding    32
    deprecated, see Section 15.2) }                                         33
                                                                              34
{bool Datatype::Get_attr(int type_keyval, void* attribute_val)                35
    const (binding deprecated, see Section 15.2) }                         36
                                                                              37
{bool Win::Get_attr(int win_keyval, void* attribute_val) const (binding     38
    deprecated, see Section 15.2) }                                         39
                                                                              40
{Group Comm::Get_group() const (binding deprecated, see Section 15.2) }    41
                                                                              42
{void Comm::Get_name(char* comm_name, int& resultlen) const (binding        43
    deprecated, see Section 15.2) }                                         44
                                                                              45
{void Datatype::Get_name(char* type_name, int& resultlen) const (binding    46
    deprecated, see Section 15.2) }                                         47
                                                                              48
{void Win::Get_name(char* win_name, int& resultlen) const (binding deprecated,
    see Section 15.2) }
                                                                              49
{int Comm::Get_rank() const (binding deprecated, see Section 15.2) }
                                                                              50
{int Group::Get_rank() const (binding deprecated, see Section 15.2) }
                                                                              51

```



```

1  {Group Intercomm::Get_remote_group() const(binding deprecated, see Section 15.2)
2      }
3
4  {int Intercomm::Get_remote_size() const(binding deprecated, see Section 15.2) }
5
6  {int Comm::Get_size() const(binding deprecated, see Section 15.2) }
7
8  {int Group::Get_size() const(binding deprecated, see Section 15.2) }
9
10 {Group Group::Incl(int n, const int ranks[]) const(binding deprecated, see
11     Section 15.2) }
12
13 {static Group Group::Intersect(const Group& group1,
14     const Group& group2) (binding deprecated, see Section 15.2) }
15
16 {bool Comm::Is_inter() const(binding deprecated, see Section 15.2) }
17
18 {Intracomm Intercomm::Merge(bool high) const(binding deprecated, see
19     Section 15.2) }
20
21 {Group Group::Range_excl(int n, const int ranges[][3]) const(binding
22     deprecated, see Section 15.2) }
23
24 {Group Group::Range_incl(int n, const int ranges[][3]) const(binding
25     deprecated, see Section 15.2) }
26
27 {void Comm::Set_attr(int comm_keyval, const void* attribute_val)
28     const(binding deprecated, see Section 15.2) }
29
30 {void Datatype::Set_attr(int type_keyval, const void*
31     attribute_val) (binding deprecated, see Section 15.2) }
32
33 {void Win::Set_attr(int win_keyval, const void* attribute_val) (binding
34     deprecated, see Section 15.2) }
35
36 {void Comm::Set_name(const char* comm_name) (binding deprecated, see
37     Section 15.2) }
38
39 {void Datatype::Set_name(const char* type_name) (binding deprecated, see
40     Section 15.2) }
41
42 {void Win::Set_name(const char* win_name) (binding deprecated, see Section 15.2) }
43
44 {Intercomm Intercomm::Split(int color, int key) const(binding deprecated, see
45     Section 15.2) }
46
47 {Intracomm Intracomm::Split(int color, int key) const(binding deprecated, see
48     Section 15.2) }
49
50 {static void Group::Translate_ranks (const Group& group1, int n,
51     const int ranks1[], const Group& group2, int ranks2[]) (binding
52     deprecated, see Section 15.2) }
53
54 {static Group Group::Union(const Group& group1,
55     const Group& group2) (binding deprecated, see Section 15.2) }

```

};

A.5.5 Process Topologies C++ Bindings

namespace MPI {

```
{void Compute_dims(int nnodes, int ndims, int dims[]) (binding deprecated, see
    Section 15.2) }
```

```
{Cartcomm Intracomm::Create_cart(int ndims, const int dims[],
    const bool periods[], bool reorder) const (binding deprecated, see
    Section 15.2) }
```

```
{Graphcomm Intracomm::Create_graph(int nnodes, const int index[],
    const int edges[], bool reorder) const (binding deprecated, see
    Section 15.2) }
```

```
{Distgraphcomm Intracomm::Dist_graph_create_adjacent(int indegree,
    const int sources[], const int sourceweights[], int outdegree,
    const int destinations[], const int destweights[],
    const Info& info, bool reorder) const (binding deprecated, see
    Section 15.2) }
```

```
{Distgraphcomm Intracomm::Dist_graph_create_adjacent(int indegree,
    const int sources[], int outdegree, const int destinations[],
    const Info& info, bool reorder) const (binding deprecated, see
    Section 15.2) }
```

```
{Distgraphcomm Intracomm::Dist_graph_create(int n, const int sources[],
    const int degrees[], const int destinations[],
    const int weights[], const Info& info, bool reorder)
    const (binding deprecated, see Section 15.2) }
```

```
{Distgraphcomm Intracomm::Dist_graph_create(int n, const int sources[],
    const int degrees[], const int destinations[],
    const Info& info, bool reorder) const (binding deprecated, see
    Section 15.2) }
```

```
{int Cartcomm::Get_cart_rank(const int coords[]) const (binding deprecated,
    see Section 15.2) }
```

```
{void Cartcomm::Get_coords(int rank, int maxdims, int coords[])
    const (binding deprecated, see Section 15.2) }
```

```
{int Cartcomm::Get_dim() const (binding deprecated, see Section 15.2) }
```

```
{void Graphcomm::Get_dims(int nnodes[], int nedges[]) const (binding
    deprecated, see Section 15.2) }
```

```
{void Distgraphcomm::Get_dist_neighbors_count(int rank, int indegree[],
    int outdegree[], bool& weighted) const (binding deprecated, see
    Section 15.2) }
```

```

1  {void Distgraphcomm::Get_dist_neighbors(int maxindgree, int sources[],
2      int sourceweights[], int maxoutdegree, int destinations[],
3      int destweights[]) (binding deprecated, see Section 15.2) }
4
5  {int Graphcomm::Get_neighbors_count(int rank) const (binding deprecated, see
6      Section 15.2) }
7
8  {void Graphcomm::Get_neighbors(int rank, int maxneighbors, int
9      neighbors[]) const (binding deprecated, see Section 15.2) }
10
11 {void Cartcomm::Get_topo(int maxdims, int dims[], bool periods[],
12     int coords[]) const (binding deprecated, see Section 15.2) }
13
14 {void Graphcomm::Get_topo(int maxindex, int maxedges, int index[],
15     int edges[]) const (binding deprecated, see Section 15.2) }
16
17 {int Comm::Get_topology() const (binding deprecated, see Section 15.2) }
18
19 {int Cartcomm::Map(int ndims, const int dims[], const bool periods[])
20     const (binding deprecated, see Section 15.2) }
21
22 {int Graphcomm::Map(int nnodes, const int index[], const int edges[])
23     const (binding deprecated, see Section 15.2) }
24
25 {void Cartcomm::Shift(int direction, int disp, int& rank_source,
26     int& rank_dest) const (binding deprecated, see Section 15.2) }
27
28 {Cartcomm Cartcomm::Sub(const bool remain_dims[]) const (binding deprecated,
29     see Section 15.2) }
30
31 };

```

A.5.6 MPI Environmental Management C++ Bindings

```

32 namespace MPI {
33
34     {void Comm::Abort(int errorcode) (binding deprecated, see Section 15.2) }
35
36     {int Add_error_class() (binding deprecated, see Section 15.2) }
37
38     {int Add_error_code(int errorclass) (binding deprecated, see Section 15.2) }
39
40     {void Add_error_string(int errorcode, const char* string) (binding deprecated,
41         see Section 15.2) }
42
43     {void* Alloc_mem(Aint size, const Info& info) (binding deprecated, see
44         Section 15.2) }
45
46     {void Comm::Call_errhandler(int errorcode) const (binding deprecated, see
47         Section 15.2) }
48
49     {void File::Call_errhandler(int errorcode) const (binding deprecated, see
50         Section 15.2) }
51
52     {void Win::Call_errhandler(int errorcode) const (binding deprecated, see
53         Section 15.2) }

```

```

{static Errhandler Comm::Create_errhandler(Comm::Errhandler_function*
    [function]comm_errhandler_fn)(binding deprecated, see Section 15.2) }
{static Errhandler File::Create_errhandler(File::Errhandler_function*
    [function]file_errhandler_fn)(binding deprecated, see Section 15.2) }
{static Errhandler Win::Create_errhandler(Win::Errhandler_function*
    [function]win_errhandler_fn)(binding deprecated, see Section 15.2) }
{void Finalize()(binding deprecated, see Section 15.2) }
{void Free_mem(void *base)(binding deprecated, see Section 15.2) }
{void Errhandler::Free()(binding deprecated, see Section 15.2) }
{Errhandler Comm::Get_errhandler() const(binding deprecated, see Section 15.2) }
{Errhandler File::Get_errhandler() const(binding deprecated, see Section 15.2) }
{Errhandler Win::Get_errhandler() const(binding deprecated, see Section 15.2) }
{int Get_error_class(int errorcode)(binding deprecated, see Section 15.2) }
{void Get_error_string(int errorcode, char* name, int& resultlen)(binding
    deprecated, see Section 15.2) }
{void Get_processor_name(char* name, int& resultlen)(binding deprecated, see
    Section 15.2) }
{void Get_version(int& version, int& subversion)(binding deprecated, see
    Section 15.2) }
{void Init(int& argc, char**& argv)(binding deprecated, see Section 15.2) }
{void Init()(binding deprecated, see Section 15.2) }
{bool Is_finalized()(binding deprecated, see Section 15.2) }
{bool Is_initialized()(binding deprecated, see Section 15.2) }
{void Comm::Set_errhandler(const Errhandler& errhandler)(binding deprecated,
    see Section 15.2) }
{void File::Set_errhandler(const Errhandler& errhandler)(binding deprecated,
    see Section 15.2) }
{void Win::Set_errhandler(const Errhandler& errhandler)(binding deprecated,
    see Section 15.2) }
{double Wtick()(binding deprecated, see Section 15.2) }
{double Wtime()(binding deprecated, see Section 15.2) }
};

```

A.5.7 The Info Object C++ Bindings

```
namespace MPI {
```

```

1  {static Info Info::Create() (binding deprecated, see Section 15.2) }
2
3  {void Info::Delete(const char* key) (binding deprecated, see Section 15.2) }
4
5  {Info Info::Dup() const (binding deprecated, see Section 15.2) }
6
7  {void Info::Free() (binding deprecated, see Section 15.2) }
8
9  {bool Info::Get(const char* key, int valuelen, char* value) const (binding
10     deprecated, see Section 15.2) }
11
12 {int Info::Get_nkeys() const (binding deprecated, see Section 15.2) }
13
14 {void Info::Get_nthkey(int n, char* key) const (binding deprecated, see
15     Section 15.2) }
16
17 {bool Info::Get_valuelen(const char* key, int& valuelen) const (binding
18     deprecated, see Section 15.2) }
19
20 {void Info::Set(const char* key, const char* value) (binding deprecated, see
21     Section 15.2) }
22
23 };

```

A.5.8 Process Creation and Management C++ Bindings

```

23 namespace MPI {
24
25     {Intercomm Intracomm::Accept(const char* port_name, const Info& info,
26         int root) const (binding deprecated, see Section 15.2) }
27
28     {void Close_port(const char* port_name) (binding deprecated, see Section 15.2) }
29
30     {Intercomm Intracomm::Connect(const char* port_name, const Info& info,
31         int root) const (binding deprecated, see Section 15.2) }
32
33     {void Comm::Disconnect() (binding deprecated, see Section 15.2) }
34
35     {static Intercomm Comm::Get_parent() (binding deprecated, see Section 15.2) }
36
37     {static Intercomm Comm::Join(const int fd) (binding deprecated, see Section 15.2)
38         }
39
40     {void Lookup_name(const char* service_name, const Info& info,
41         char* port_name) (binding deprecated, see Section 15.2) }
42
43     {void Open_port(const Info& info, char* port_name) (binding deprecated, see
44         Section 15.2) }
45
46     {void Publish_name(const char* service_name, const Info& info,
47         const char* port_name) (binding deprecated, see Section 15.2) }
48
49     {Intercomm Intracomm::Spawn(const char* command, const char* argv[],
50         int maxprocs, const Info& info, int root) const (binding
51         deprecated, see Section 15.2) }

```

```

{Intercomm Intracomm::Spawn(const char* command, const char* argv[],
    int maxprocs, const Info& info, int root,
    int array_of_errcodes[]) const(binding deprecated, see Section 15.2)
    }
}

{Intercomm Intracomm::Spawn_multiple(int count,
    const char* array_of_commands[], const char** array_of_argv[],
    const int array_of_maxprocs[], const Info array_of_info[],
    int root, int array_of_errcodes[]) (binding deprecated, see
    Section 15.2) }

{Intercomm Intracomm::Spawn_multiple(int count,
    const char* array_of_commands[], const char** array_of_argv[],
    const int array_of_maxprocs[], const Info array_of_info[],
    int root) (binding deprecated, see Section 15.2) }

{void Unpublish_name(const char* service_name, const Info& info,
    const char* port_name) (binding deprecated, see Section 15.2) }

};

```

A.5.9 One-Sided Communications C++ Bindings

```

namespace MPI {

{void Win::Accumulate(const void* origin_addr, int origin_count, const
    Datatype& origin_datatype, int target_rank, Aint target_disp,
    int target_count, const Datatype& target_datatype, const Op&
    op) const(binding deprecated, see Section 15.2) }

{void Win::Complete() const(binding deprecated, see Section 15.2) }

{static Win Win::Create(const void* base, Aint size, int disp_unit, const
    Info& info, const Intracomm& comm) (binding deprecated, see
    Section 15.2) }

{void Win::Fence(int assert) const(binding deprecated, see Section 15.2) }

{void Win::Free() (binding deprecated, see Section 15.2) }

{Group Win::Get_group() const(binding deprecated, see Section 15.2) }

{void Win::Get(void *origin_addr, int origin_count,
    const Datatype& origin_datatype, int target_rank,
    Aint target_disp, int target_count,
    const Datatype& target_datatype) const(binding deprecated, see
    Section 15.2) }

{void Win::Lock(int lock_type, int rank, int assert) const(binding
    deprecated, see Section 15.2) }

{void Win::Post(const Group& group, int assert) const(binding deprecated, see
    Section 15.2) }
}

```

```

1   {void Win::Put(const void* origin_addr, int origin_count,
2               const Datatype& origin_datatype, int target_rank,
3               Aint target_disp, int target_count,
4               const Datatype& target_datatype) const(binding deprecated, see
5               Section 15.2) }
6
7   {void Win::Start(const Group& group, int assert) const(binding deprecated,
8               see Section 15.2) }
9
10  {bool Win::Test() const(binding deprecated, see Section 15.2) }
11
12  {void Win::Unlock(int rank) const(binding deprecated, see Section 15.2) }
13
14  {void Win::Wait() const(binding deprecated, see Section 15.2) }
15
16  };

```

A.5.10 External Interfaces C++ Bindings

```

17  namespace MPI {
18
19      {void Grequest::Complete() (binding deprecated, see Section 15.2) }
20
21      {int Init_thread(int& argc, char**& argv, int required) (binding deprecated,
22          see Section 15.2) }
23
24      {int Init_thread(int required) (binding deprecated, see Section 15.2) }
25
26      {bool Is_thread_main() (binding deprecated, see Section 15.2) }
27
28      {int Query_thread() (binding deprecated, see Section 15.2) }
29
30      {void Status::Set_cancelled(bool flag) (binding deprecated, see Section 15.2) }
31
32      {void Status::Set_elements(const Datatype& datatype, int count) (binding
33          deprecated, see Section 15.2) }
34
35      {static Grequest Grequest::Start(const Grequest::Query_function*
36          query_fn, const Grequest::Free_function* free_fn,
37          const Grequest::Cancel_function* cancel_fn,
38          void *extra_state) (binding deprecated, see Section 15.2) }
39
40  };

```

A.5.11 I/O C++ Bindings

```

41  namespace MPI {
42
43      {void File::Close() (binding deprecated, see Section 15.2) }
44
45      {static void File::Delete(const char* filename, const Info& info) (binding
46          deprecated, see Section 15.2) }
47
48      {int File::Get_amode() const(binding deprecated, see Section 15.2) }

```

```

{bool File::Get_atomicity() const(binding deprecated, see Section 15.2) } 1
{Offset File::Get_byte_offset(const Offset disp) const(binding deprecated, 2
see Section 15.2) } 3
{Group File::Get_group() const(binding deprecated, see Section 15.2) } 5
{Info File::Get_info() const(binding deprecated, see Section 15.2) } 7
{Offset File::Get_position() const(binding deprecated, see Section 15.2) } 8
{Offset File::Get_position_shared() const(binding deprecated, see Section 15.2) } 10
{Offset File::Get_size() const(binding deprecated, see Section 15.2) } 11
{Aint File::Get_type_extent(const Datatype& datatype) const(binding 13
deprecated, see Section 15.2) } 14
{void File::Get_view(Offset& disp, Datatype& etype, Datatype& filetype, 15
char* datarep) const(binding deprecated, see Section 15.2) } 16
{Request File::Iread_at(Offset offset, void* buf, int count, 18
const Datatype& datatype) (binding deprecated, see Section 15.2) } 19
{Request File::Iread_shared(void* buf, int count, 20
const Datatype& datatype) (binding deprecated, see Section 15.2) } 21
{Request File::Iread(void* buf, int count, 23
const Datatype& datatype) (binding deprecated, see Section 15.2) } 24
{Request File::Iwrite_at(Offset offset, const void* buf, int count, 25
const Datatype& datatype) (binding deprecated, see Section 15.2) } 26
{Request File::Iwrite(const void* buf, int count, 28
const Datatype& datatype) (binding deprecated, see Section 15.2) } 29
{Request File::Iwrite_shared(const void* buf, int count, 30
const Datatype& datatype) (binding deprecated, see Section 15.2) } 31
{static File File::Open(const Intracomm& comm, const char* filename, 33
int amode, const Info& info) (binding deprecated, see Section 15.2) } 34
{void File::Preallocate(Offset size) (binding deprecated, see Section 15.2) } 35
{void File::Read_all_begin(void* buf, int count, 37
const Datatype& datatype) (binding deprecated, see Section 15.2) } 38
{void File::Read_all_end(void* buf, Status& status) (binding deprecated, see 39
Section 15.2) } 40
{void File::Read_all_end(void* buf) (binding deprecated, see Section 15.2) } 42
{void File::Read_all(void* buf, int count, const Datatype& datatype, 44
Status& status) (binding deprecated, see Section 15.2) } 45
{void File::Read_all(void* buf, int count, 46
const Datatype& datatype) (binding deprecated, see Section 15.2) } 47

```



```

1  {void File::Read_at_all_begin(Offset offset, void* buf, int count,
2      const Datatype& datatype) (binding deprecated, see Section 15.2) }
3
4  {void File::Read_at_all_end(void* buf, Status& status) (binding deprecated,
5      see Section 15.2) }
6
7  {void File::Read_at_all_end(void* buf) (binding deprecated, see Section 15.2) }
8
9  {void File::Read_at_all(Offset offset, void* buf, int count,
10     const Datatype& datatype, Status& status) (binding deprecated, see
11     Section 15.2) }
12
13 {void File::Read_at_all(Offset offset, void* buf, int count,
14     const Datatype& datatype) (binding deprecated, see Section 15.2) }
15
16 {void File::Read_at(Offset offset, void* buf, int count,
17     const Datatype& datatype, Status& status) (binding deprecated, see
18     Section 15.2) }
19
20 {void File::Read_at(Offset offset, void* buf, int count,
21     const Datatype& datatype) (binding deprecated, see Section 15.2) }
22
23 {void File::Read_ordered_begin(void* buf, int count,
24     const Datatype& datatype) (binding deprecated, see Section 15.2) }
25
26 {void File::Read_ordered_end(void* buf, Status& status) (binding deprecated,
27     see Section 15.2) }
28
29 {void File::Read_ordered_end(void* buf) (binding deprecated, see Section 15.2) }
30
31 {void File::Read_ordered(void* buf, int count, const Datatype& datatype,
32     Status& status) (binding deprecated, see Section 15.2) }
33
34 {void File::Read_ordered(void* buf, int count,
35     const Datatype& datatype) (binding deprecated, see Section 15.2) }
36
37 {void File::Read_shared(void* buf, int count, const Datatype& datatype,
38     Status& status) (binding deprecated, see Section 15.2) }
39
40 {void File::Read_shared(void* buf, int count,
41     const Datatype& datatype) (binding deprecated, see Section 15.2) }
42
43 {void File::Read(void* buf, int count, const Datatype& datatype, Status&
44     status) (binding deprecated, see Section 15.2) }
45
46 {void File::Read(void* buf, int count, const Datatype& datatype) (binding
47     deprecated, see Section 15.2) }
48
49 {void Register_datarep(const char* datarep,
50     Datarep_conversion_function* read_conversion_fn,
51     Datarep_conversion_function* write_conversion_fn,
52     Datarep_extent_function* dtype_file_extent_fn,
53     void* extra_state) (binding deprecated, see Section 15.2) }

```



```

{void File::Seek(Offset offset, int whence) (binding deprecated, see
    Section 15.2) }
1
2
3
{void File::Seek_shared(Offset offset, int whence) (binding deprecated, see
    Section 15.2) }
4
5
6
{void File::Set_atomicsity(bool flag) (binding deprecated, see Section 15.2) }
7
8
{void File::Set_info(const Info& info) (binding deprecated, see Section 15.2) }
9
10
{void File::Set_size(Offset size) (binding deprecated, see Section 15.2) }
11
12
{void File::Set_view(Offset disp, const Datatype& etype,
    const Datatype& filetype, const char* datarep,
    const Info& info) (binding deprecated, see Section 15.2) }
13
14
{void File::Sync() (binding deprecated, see Section 15.2) }
15
16
{void File::Write_all_begin(const void* buf, int count,
    const Datatype& datatype) (binding deprecated, see Section 15.2) }
17
18
{void File::Write_all(const void* buf, int count,
    const Datatype& datatype, Status& status) (binding deprecated, see
    Section 15.2) }
19
20
21
{void File::Write_all(const void* buf, int count,
    const Datatype& datatype) (binding deprecated, see Section 15.2) }
22
23
{void File::Write_all_end(const void* buf, Status& status) (binding
    deprecated, see Section 15.2) }
24
25
26
{void File::Write_all_end(const void* buf) (binding deprecated, see Section 15.2) }
27
28
29
{void File::Write_at_all_begin(Offset offset, const void* buf, int count,
    const Datatype& datatype) (binding deprecated, see Section 15.2) }
30
31
{void File::Write_at_all_end(const void* buf, Status& status) (binding
    deprecated, see Section 15.2) }
32
33
34
{void File::Write_at_all_end(const void* buf) (binding deprecated, see
    Section 15.2) }
35
36
{void File::Write_at_all(Offset offset, const void* buf, int count,
    const Datatype& datatype, Status& status) (binding deprecated, see
    Section 15.2) }
37
38
39
{void File::Write_at_all(Offset offset, const void* buf, int count,
    const Datatype& datatype) (binding deprecated, see Section 15.2) }
40
41
42
{void File::Write_at(Offset offset, const void* buf, int count,
    const Datatype& datatype, Status& status) (binding deprecated, see
    Section 15.2) }
43
44
45
{void File::Write_at(Offset offset, const void* buf, int count,
    const Datatype& datatype) (binding deprecated, see Section 15.2) }
46
47
48

```

```

1   {void File::Write(const void* buf, int count, const Datatype& datatype,
2       Status& status) (binding deprecated, see Section 15.2) }
3
4   {void File::Write(const void* buf, int count,
5       const Datatype& datatype) (binding deprecated, see Section 15.2) }
6
7   {void File::Write_ordered_begin(const void* buf, int count,
8       const Datatype& datatype) (binding deprecated, see Section 15.2) }
9
10  {void File::Write_ordered(const void* buf, int count,
11      const Datatype& datatype, Status& status) (binding deprecated, see
12      Section 15.2) }
13
14  {void File::Write_ordered(const void* buf, int count,
15      const Datatype& datatype) (binding deprecated, see Section 15.2) }
16
17  {void File::Write_ordered_end(const void* buf, Status& status) (binding
18      deprecated, see Section 15.2) }
19
20  {void File::Write_shared(const void* buf, int count,
21      const Datatype& datatype, Status& status) (binding deprecated, see
22      Section 15.2) }
23
24  {void File::Write_shared(const void* buf, int count,
25      const Datatype& datatype) (binding deprecated, see Section 15.2) }
26
27  };

```

A.5.12 Language Bindings C++ Bindings

```

30 namespace MPI {
31
32     {static Datatype Datatype::Create_f90_complex(int p, int r) (binding
33         deprecated, see Section 15.2) }
34
35     {static Datatype Datatype::Create_f90_integer(int r) (binding deprecated, see
36         Section 15.2) }
37
38     {static Datatype Datatype::Create_f90_real(int p, int r) (binding deprecated,
39         see Section 15.2) }
40
41     Exception::Exception(int error_code)
42
43     {int Exception::Get_error_class() const (binding deprecated, see Section 15.2) }
44
45     {int Exception::Get_error_code() const (binding deprecated, see Section 15.2) }
46
47     {const char* Exception::Get_error_string() const (binding deprecated, see
48         Section 15.2) }
49
50     {static Datatype Datatype::Match_size(int typeclass, int size) (binding
51         deprecated, see Section 15.2) }

```

};

A.5.13 Profiling Interface C++ Bindings

namespace MPI {

```
    {void Pcontrol(const int level, ...) (binding deprecated, see Section 15.2) }
```

};

[\[C++ Deprecated Functions section\]](#)

A.5.14 C++ Bindings on all MPI Classes

The C++ language requires all classes to have four special functions: a default constructor, a copy constructor, a destructor, and an assignment operator. The bindings for these functions are listed below; their semantics are discussed in Section 16.1.5. The two constructors are *not virtual*. The bindings prototype functions are using the type `<CLASS>` rather than listing each function for every MPI class. The token `<CLASS>` can be replaced with valid MPI-2 class names, such as `Group`, `Datatype`, etc., except when noted. In addition, bindings are provided for comparison and inter-language operability from Sections 16.1.5 and 16.1.9.

A.5.15 Construction / Destruction

namespace MPI {

```
    <CLASS>::<CLASS>()
```

```
    <CLASS>::~~<CLASS>()
```

};

A.5.16 Copy / Assignment

namespace MPI {

```
    <CLASS>::<CLASS>(const <CLASS>& data)
```

```
    <CLASS>& <CLASS>::operator=(const <CLASS>& data)
```

};

A.5.17 Comparison

Since `Status` instances are not handles to underlying MPI objects, the `operator==()` and `operator!=()` functions are not defined on the `Status` class.

namespace MPI {

```
    bool <CLASS>::operator==(const <CLASS>& data) const
```

```
    bool <CLASS>::operator!=(const <CLASS>& data) const
```

};

1 A.5.18 Inter-language Operability

2
3 Since there are no C++ MPI::STATUS_IGNORE and MPI::STATUSES_IGNORE objects, the
4 result of promoting the C or Fortran handles (MPI_STATUS_IGNORE and
5 MPI_STATUSES_IGNORE) to C++ is undefined.

```
6 namespace MPI {  
7  
8     <CLASS>& <CLASS>::operator=(const MPI_<CLASS>& data)  
9  
10    <CLASS>::<CLASS>(const MPI_<CLASS>& data)  
11  
12    <CLASS>::operator MPI_<CLASS>() const  
13  
14 };
```

Annex B

Change-Log

This annex summarizes changes from the previous version of the MPI standard to the version presented by this document. Only significant changes (i.e., clarifications and new features) that might either require implementation effort in the MPI libraries or change the understanding of MPI from a user’s perspective are presented. Editorial modifications, formatting, typo corrections and minor clarifications are not shown.

B.1 Changes from Version 2.2 to Version 3.0

1. Section 16.1.6 on page 635, and MPI-2.2 Section 16.1.16 on page 471, line 45.
This is an MPI-2.2 errata: The constant `MPI::LONG_LONG` should be `MPI::LONG_LONG`.
TICKET NOT YET PASSED. NEW CHANGE-LOG TEXT.
2. Section 13.5.2, Table 13.2 on page 564, and MPI-2.2, Section 13.5.3, Table 13.2 on page 433.
This is an MPI-2.2 errata: The `MPI_C_BOOL` “external32” representation is corrected to a 1-byte size.
TICKET PASSED. NEW CHANGE-LOG TEXT.
3. Section 7.5.5 on page 317, and MPI-2.2, Section 7.5.5 on page 257, C++ interface on page 264, line 3.
This is an MPI-2.2 errata: In the C++ interface of `MPI_DIST_GRAPH_NEIGHBORS_COUNT`, the argument `rank` is removed.
TICKET NOT YET PASSED (Had 1st vote). NEW CHANGE-LOG TEXT.
4. Annex A.1.1 on page 713, Table “Optional datatypes (Fortran)”, and MPI-2.2, Annex A.1.1, Table on page 517, lines 34, and 37-41.
This is an MPI-2.2 errata: The C++ datatype handles `MPI::INTEGER16`, `MPI::REAL16`, `MPI::F_COMPLEX4`, `MPI::F_COMPLEX8`, `MPI::F_COMPLEX16`, `MPI::F_COMPLEX32` where added to the table.
TICKET NOT YET PASSED. NEW CHANGE-LOG TEXT.
5. Sections 3.8.2, 3.8.3, 16.3.4, A.1.1 on pages 75, 76, 697, 713.
Like `MPI_PROBE` and `MPI_Iprobe`, the new `MPI_Mprobe` and `MPI_improbe` operations allow incoming messages to be queried without actually receiving them, except that `MPI_Mprobe` and `MPI_improbe` provide a mechanism

1 to receive the specific message with the new routine `MPI_MRECV` regardless of other
 2 intervening probe or receive operations. The opaque object `MPI_Message`, the null
 3 handle `MPI_MESSAGE_NULL`, and the conversion functions `MPI_Message_c2f` and
 4 `MPI_Message_f2c` are defined.

5 TICKETS 38+274 PASSED. NEW CHANGE-LOG TEXT.

- 6
 7 6. Chapter 5 on page 151 and Section 5.12 on page 209.
 8 Added nonblocking interfaces to all collective operations.

9 TEXT AS PASSED.

- 10
 11 7. Section 2.3 on page 10.
 12 Clarified parameter usage for IN parameters. C bindings are now const-correct where
 13 backward compatibility is preserved.

14 TICKET AS PASSED. Reference updated from Section 2 to Section 2.3

- 15 8. Chapter 3 on page 27 until Chapter 16 on page 631.
 16 In the C language bindings, the array-arguments' interfaces are modified to consi-
 17 stently to always use use `[]` instead of `*`, and the 'const' keyword has been added to
 18 many functions.

19 TICKET PASSED. NEW CHANGE-LOG TEXT.

- 20
 21 9. Section 7.5.8 on page 328.
 22 `MPI_CART_MAP` can also be used for a zero-dimensional topologies.

23 TEXT AS PASSED.

- 24
 25 10. Section 6.4.2 on page 252.
 26 Added `MPI_COMM_IDUP`.

27 TEXT AS PASSED.

- 28
 29 11. Section 2.5.4 on page 15 and Section 8.1.1 on page 351.
 30 Added new routine `MPI_GET_LIBRARY_VERSION` to query library specific versions,
 31 and the constant `MPI_MAX_LIBRARY_VERSION_STRING`.

32 TICKET PASSED. MODIFIED CHANGE-LOG TEXT.

- 33
 34 12. Section 6.8 on page 295.
 35 Section 6.8 on page 238. The constant `MPI_MAX_OBJECT_NAME` also applies for type
 36 and window names.

- 37
 38 13. Section ?? on page ??.

39 I ASKED GEORGE TO SET THE MISSING LABEL AT "12.4.3 Initialization"

40 IT MUST BE DECIDED, WHICH OPTION WE USE ABOUT SAME
 41 required ARGUMENT WHEN CALLING `MPI_INIT_THREAD`.

42 TICKET NOT YET PASSED. CHANGE-LOG TEXT MUST BE ALSO DEFINED.

- 43
 44 14. Section 3.8 on page 71 and Section 3.11 on page 89.
 45 The use of `MPI_PROC_NULL` in probe and matching probe operations was clarified. A
 46 special predefined message `MPI_MESSAGE_NO_PROC` is defined for the use of matching
 47 probe with `MPI_PROC_NULL`.

48 TICKET 256 NOT YET PASSED (Had 1st vote). CHANGE-LOG TEXT AS DEFINED IN TICKET.

TICKET 328 NOT YET PASSED (Had 1st vote). NEW CHANGE-LOG TEXT.

ticket299.
ticket258.

15. Section 7.6 on page 330 and Section 7.7 on page 339.
The neighborhood collective communication routines are added to support sparse communication on virtual topology grids: MPI_NEIGHBOR_ALLGATHER, MPI_NEIGHBOR_ALLGATHERV, MPI_NEIGHBOR_ALLTOALL, MPI_NEIGHBOR_ALLTOALLV, MPI_NEIGHBOR_ALLTOALLW and the nonblocking variants MPI_INEIGHBOR_ALLGATHER, MPI_INEIGHBOR_ALLGATHERV, MPI_INEIGHBOR_ALLTOALL, MPI_INEIGHBOR_ALLTOALLV, and MPI_INEIGHBOR_ALLTOALLW. The displacement arguments in MPI_NEIGHBOR_ALLTOALLW and MPI_INEIGHBOR_ALLTOALLW are defined as address size integers. In MPI_DIST_GRAPH_NEIGHBORS, an ordering rule is added for communicators created with MPI_DIST_GRAPH_CREATE_ADJACENT.
TICKET PASSED. MODIFIED CHANGE-LOG TEXT.
16. Sections 2.5.8, 3.2.2, 3.3, 5.9.2, on pages 17, 29, 31, 188, Sections ??, ??, ??, 4.1.11, 12.3 on pages ??, ??, ??, 121, 503, and Annex A.1.1 on page 713.
New inquiry functions, MPI_TYPE_SIZE_X, MPI_TYPE_GET_EXTENT_X, MPI_TYPE_GET_TRUE_EXTENT_X, and MPI_GET_ELEMENTS_X, return their results as an MPI_Count value, which is a new type large enough to represent element counts in memory, file views, etc. A new function, MPI_STATUS_SET_ELEMENTS_X, modifies the opaque part of MPI_STATUS so that a call to MPI_GET_ELEMENTS_X returns the provided MPI_Count value (in Fortran, INTEGER (KIND=MPI_COUNT_KIND)). The corresponding predefined datatype is MPI_COUNT.
TICKET PASSED. CHANGE-LOG TEXT EXTENDED BY Fortran AND predefined datatype.
17. Sections ??, ??, ??, ?? on pages ??, ??, ??, ??.
The functions MPI_GET_COUNT, MPI_TYPE_SIZE, and MPI_GET_ELEMENTS are now defined to set the count parameter to MPI_UNDEFINED when that parameter would overflow. The function MPI_PACK_SIZE is now defined to set the size parameter to MPI_UNDEFINED when that parameter would overflow. In all other MPI-2.2 routines, the type and semantics of the count arguments are kept unchanged, i.e., int or INTEGER.
TEXT AS PASSED.
18. Section 8.7 on page 375.
Allow calls to MPI_T routines before MPI_INIT and after MPI_FINALIZE.
TICKET PASSED. MODIFIED CHANGE-LOG TEXT.
19. Section 14.3 on page 592.
A new MPI Tool Information Interface is added.
TICKET PASSED. MODIFIED CHANGE-LOG TEXT.
20. Chapter 11 on page 423.
Substantial revision of the entire One-sided chapter, with new routines for window creation, additional synchronization methods in passive target, new one-sided communication routines, a new memory model, and other changes.
Ticket 270, TEXT AS PASSED. Ticket 284, NO ADDITIONAL CHANGE-LOG.
21. Sections 6.4.2, ??, ??, on pages 252, ??, ??.
I ASKED ADAM FOR THE MISSING LABELS of “6.4.4 Communicator Info” and “11.2.3 Window Info”

1
2
3
4
5
6
7
8
9
10
11
12
13
14 ticket265.
15
16
17
18
19
20
21
22
23
24 ticket265.
25
26
27
28
29
30
31
32
33 ticket266.
34
35
36
37 ticket266.
38
39
40 ticket284.
41 ticket300.
42 ticket270.
43
44
45
46 ticket271.
47
48

1 The new routines `MPI_COMM_DUP_INFO`, `MPI_COMM_SET_INFO`,
 2 `MPI_COMM_GET_INFO`, `MPI_WIN_SET_INFO`, and `MPI_WIN_GET_INFO` are added.
 3 The routine `MPI_COMM_DUP` must also duplicate topology information and info
 4 hints.

ticket279. 5 TICKET NOT YET PASSED (Had 1st vote). NEW CHANGE-LOG TEXT.
 6

- 7 22. Chapter 16.1.1 on page 631.
 8 Added a sentence making the C++ bindings optional.

9 TEXT AS PASSED.

ticket280. 10 CAUTION: MAY BE OBSOLETE WITH TICKET 281!
 11

- 12 23. Section 4.1.2 on page 93 and Section 4.1.13 on page 124.
 13 The routine `MPI_TYPE_CREATE_HINDEXED_BLOCK` and constant
 14 `MPI_COMBINER_HINDEXED_BLOCK` are added.

ticket281. 15 TICKET PASSED. MODIFIED CHANGE-LOG TEXT.
 16

- 17 24. Section ?? on page ?? and all other chapters.

18 THIS LABEL IS ONLY AVAILABLE AFTER TICKET 281 IS INCLUDED.

19 The C++ bindings are removed from the standard. See MPI-2.2 errata at the begin-
 20 ning of this list for latest changes to the MPI C++ binding defined in MPI-2.2.

ticket286. 21 TICKET NOT YET PASSED (Had 1st vote). NEW CHANGE-LOG TEXT.
 22

- 23 25. Section 6.4.2 on page 252.
 24 New communicator construction routine `MPI_COMM_CREATE_GROUP`, which is in-
 25 voked only by the processes in the group of the new communicator being constructed.

ticket287. 26 TICKET PASSED. NEW CHANGE-LOG TEXT.
 27

- 28 26. Section 6.4.2 on page 252.
 29 Added `MPI_COMM_SPLIT_TYPE` function and the communicator split type constant
 30 `MPI_COMM_TYPE_SHARED`.

ticket294. 31 TICKET PASSED. MODIFIED CHANGE-LOG TEXT.
 32

- 33 27. Section 2.5.4 on page 15 and Section 7.5.4 on page 310.
 34 The recommended C implementation value for `MPI_UNWEIGHTED` was changed from
 35 NULL to non-NULL. An additional weight array constant (`MPI_WEIGHTS_EMPTY`)
 36 was introduced.

ticket303. 37 TICKET NOT YET PASSED (Had 1st vote). CHANGE-LOG TEXT AS DEFINED IN TICKET.
 38

- 39 28. Section 15.1 on page 621 and Section ?? on page ??.
 40 The deprecated functions `MPI_TYPE_HVECTOR`, `MPI_TYPE_HINDEXED`,
 41 `MPI_TYPE_STRUCT`, `MPI_ADDRESS`, `MPI_TYPE_EXTENT`, `MPI_TYPE_LB`,
 42 `MPI_TYPE_UB`, `MPI_ERRHANDLER_CREATE` (and its callback function prototype
 43 `MPI_Handler_function`), `MPI_ERRHANDLER_SET`, `MPI_ERRHANDLER_GET`, the dep-
 44recated special datatype handles `MPI_LB`, `MPI_UB`, and the constants
 45 `MPI_COMBINER_HINDEXED_INTEGER`, `MPI_COMBINER_HVECTOR_INTEGER`,
 46 `MPI_COMBINER_STRUCT_INTEGER` are removed from the standard.

ticket305. 47 TICKET NOT YET PASSED (Had 1st vote). NEW CHANGE-LOG TEXT.
 48

- 49 29. Section 6.6.2 on page 272.
 50 The scope of the tag argument in `MPI_INTERCOMM_CREATE` is shrunk to the use

- in this routine.
- TICKET PASSED. NEW CHANGE-LOG TEXT.
- 1
2 ticket313.
3
4
5
6
7
8
9
10
11 ticket318.
12
13
14
15
16
17 ticket322.
18
19
20
21
22 ticket340.
23
24
25
26
27
28
29
30
31
32 ticket281.
33
34 ticket340.
35
36
37
38 ticket230-B.
39 ticket247-S.
40 ticket248-T.
41 ticket229.7.
42 ticket231-C.
43
44
45
46
47
48
30. Section 8.7 on page 375 and Section ?? on page ??.
- I ASKED GEORGE TO SET THE MISSING LABEL AT "12.4.3 Initialization"
- The use of MPI_INIT, MPI_INIT_THREAD and MPI_FINALIZE is clarified. After MPI is initialized, the application can access information about the execution environment by querying the new predefined info object MPI_INFO_GET_ENV.
- TICKET NOT YET PASSED (Had 1st vote). NEW CHANGE-LOG TEXT.
- CAUTION: There are three locations of MPI_INFO_KEY. I expect that this is a typo and should mean MPI_INFO_GET_ENV.
31. Sections 5.9.2, 13.5.2 Table 13.2, and Annex A.1.1 on pages 188, 564, and 713. New named optional predefined datatypes MPI_QUAD, MPI_C_QUAD_COMPLEX, MPI_FLOAT128, and MPI_C_FLOAT128_COMPLEX for the C types _Quad, __float128, _Quad_Complex, and __float128_Complex.
- TICKET NOT YET PASSED. CHANGE-LOG TEXT AS ON TICKET.
32. Section 6.7.2 on page 279.
- Section 6.7.2 on page 226. It was clarified that in Fortran, the flag values of a comm_copy_attr_fn callback and of MPI_COMM_NULL_COPY_FN and MPI_COMM_DUP_FN are .FALSE. and .TRUE.; see MPI_COMM_CREATE_KEYVAL.
- TICKET PASSED. MODIFIED CHANGE-LOG TEXT.
33. Sections 5.9.2, 13.5.2 Table 13.2, and Annex A.1.1 on pages 188, 564, and 713, and MPI-2.2 Sections 5.9.2, 13.5.2 Table 13.2, and Annex A.1.1 on pages 164, 433, and 513.
- MPI-2.2 errata: New named predefined datatypes MPI_CXX_BOOL, MPI_CXX_FLOAT_COMPLEX, MPI_CXX_DOUBLE_COMPLEX, and MPI_CXX_LONG_DOUBLE_COMPLEX in C and Fortran for the C++ types bool, Complex<float>, Complex<double>, and Complex<long double>, corresponding to the deprecated C++ predefined datatypes MPI::BOOL, MPI::COMPLEX, MPI::DOUBLE_COMPLEX, and MPI::LONG_DOUBLE_COMPLEX, which are removed in MPI-3.0.
- TICKET NOT YET PASSED. CHANGE-LOG TEXT AS ON TICKET.
34. Sections 5.9.2 on pages 188.
- MPI_C_COMPLEX is added to the "Complex" reduction group.
- TICKET NOT YET PASSED. CHANGE-LOG TEXT AS ON TICKET.
35. Section 2.3 on page 10, and Sections 16.2.1, 16.2.2, 16.2.7 on pages 644, 646, and 661. The new mpi_08 Fortran module is introduced.
36. Section 2.5.1 on page 12, Section 16.2.2 on page 646, and Section 16.2.3 on page 648, Section 16.2.7 on page 661.
- Handles to opaque objects are defined as named types within the mpi_08 Fortran module. The operators .EQ., .NE., == and /= are overloaded to allow the comparison of these handles. The handle types and the overloaded operators are also available through the mpi Fortran module.

ticket234-F.
 ticket235-G.
 ticket236-H.

- 1
 2
 3 37. Sections 2.5.4, 2.5.5 on pages 15, 16, Sections 16.2.1, 16.2.10, 16.2.11, 16.2.12, 16.2.13
 4 on pages 644, 672, 674, 675, 678, and Sections 16.2.2, 16.2.3, 16.2.7 on pages 646, 648,
 5 661.
 6 Within the `mpi_08` Fortran module, choice buffers are defined as assumed-type and
 7 assumed-rank according to Fortran 2008 TR 29113 [41], and the compile-time constant
 8 `MPI_SUBARRAYS_SUPPORTED` is set to `.TRUE..` With this, Fortran subscript triplets
 9 can be used in nonblocking MPI operations; vector subscripts are not supported in
 10 nonblocking operations. If the compiler does not support this Fortran TR 29113
 11 feature, the constant is set to `.FALSE..`
 ticket239-K.
 12 38. Section 2.6.2 on page 18, Section 16.2.2 on page 646, and Section 16.2.7 on page 661.
 13 The `ierorr` dummy arguments are `OPTIONAL` within the `mpi_08` Fortran module.
 ticket243-O.
 14 39. Section 3.2.5 on page 34, Section 16.2.2 on page 646, Section 16.2.3 on page 648,
 15 Section 16.2.7 on page 661, and Section 16.3.5 on page 700.
 16 Within the `mpi_08` Fortran module, the status is defined as `TYPE(MPI_Status)`. New
 17 conversion routines are added: `MPI_STATUS_F2F08`, `MPI_STATUS_F082F`,
 18 `MPI_Status_c2f08`, and `MPI_Status_f082c`. In `mpi.h`, the new type `MPI_F08_status`,
 19 and the external variables `MPI_F08_STATUS_IGNORE` and `MPI_F08_STATUSES_IGNORE`
 20 are added.
 ticket38.
 21
 ticket274.
 22 40. Section 3.2.6 on page 36, and Section 3.8 on page 71.
 23 `MPI_STATUS_IGNORE` can be also used in `MPI_IPROBE`, `MPI_PROBE`, `MPI_IMPROBE`,
 24 and `MPI_MPROBE`.
 ticket229.2.
 25
 26 41. Section 3.6 on page 49.
 27 In Fortran with the `mpi` module or `mpif.h`, the type of the `buffer_addr` argument of
 28 `MPI_BUFFER_DETACH` is wrongly defined and the argument is therefore unused.
 ticket237-I.
 29
 ticket229.2.
 30 42. Section 4.1 on page 91, Section 4.1.6 on page 112, and Section 16.2.15 on page 679.
 31 The Fortran alignments of basic datatypes are implementation dependent. It is rec-
 32 ommended that they are computed according to `BIND(C)` derived types. If an array
 33 of structures (in C/C++) or derived types (in Fortran) should be communicated, it
 34 is recommended that the user creates a portable datatype handle and applies addi-
 35 tionally `MPI_TYPE_CREATE_RESIZED` to this datatype handle.
 ticket252-W.
 36
 37 43. Sections 4.1.10, 5.9.5, 5.9.7, 6.7.4, 6.8, 8.3.1, 8.3.2, 8.3.3, 15.1, 16.2.9 on pages 119,
 38 195, 201, 289, 295, 360, 362, 364, 621, and 664. In some routines, the dummy arg-
 39 ument names were changed because they were identical to the Fortran keywords
 40 `TYPE` and `FUNCTION`. The new dummy argument names must be used because the
 41 `mpi` and `mpi_08` modules guarantee keyword-based actual argument lists. The arg-
 42 ument name `type` was changed into `oldtype` in `MPI_TYPE_DUP`, and into `datatype`
 43 in the Fortran `USER_FUNCTION` of `MPI_OP_CREATE`, and in `MPI_TYPE_SET_ATTR`,
 44 `MPI_TYPE_GET_ATTR`, `MPI_TYPE_DELETE_ATTR`, `MPI_TYPE_SET_NAME`,
 45 `MPI_TYPE_GET_NAME`, `MPI_TYPE_MATCH_SIZE`, in the callback prototype defi-
 46 nition `MPI_Type_delete_attr_function`, and the predefined callback function
 47 `MPI_TYPE_NULL_DELETE_FN`; function was changed into `user_fn` in
 48 `MPI_OP_CREATE`, into `comm_errhandler_fn` in `MPI_COMM_CREATE_ERRHANDLER`,
 into `win_errhandler_fn` in `MPI_WIN_CREATE_ERRHANDLER`, into `file_errhandler_fn` in

MPI_FILE_CREATE_ERRHANDLER, into handler_fn in MPI_ERRHANDLER_CREATE.
 For consistency reasons, INOUBUF was changed into INOUTBUF in
 MPI_REDUCE_LOCAL, and intracomm into newintracomm in
 MPI_INTERCOMM_MERGE.

44. Section 8.2 on page 355.

In Fortran with the mpi and mpi_f08 modules, MPI_ALLOC_MEM now also supports
 TYPE(C_PTR) C-pointer instead of only returning an address-sized integer that may
 be usable together with a non-standard Cray-pointer. The Fortran interfaces with
 INTEGER(KIND=MPI_ADDRESS_KIND) BASEPTR in the mpi module and the mpif.h
 include file are deprecated since MPI-3.0.

45. Section 16.2.15 on page 679, and Section 16.2.7 on page 661.

Fortran SEQUENCE and BIND(C) derived application types can be used as buffers in
 MPI operations.

46. Section 16.2.16 on page 681 to Section 16.2.19 on page 692, Section 16.2.7 on page 661,
 and Section 16.2.8 on page 663.

The sections about Fortran optimization problems and their solution is partially
 rewritten and new methods are added, e.g., the use of the ASYNCHRONOUS attribute.
 The constant MPI_ASYNC_PROTECTS_NONBLOCKING tells whether the meaning of the
 ASYNCHRONOUS attribute is extended to protect nonblocking operations. The Fortran
 routine MPI_F_SYNC_REG is added. To achieve a secure and portable programming
 interfaces, in Section 16.2.7, several requirements are defined for the combination of
 an MPI library and a Fortran compiler to be MPI-3.0 compliant.

47. Section 16.2.4 on page 651.

The use of the mpif.h Fortran include file is strongly discouraged.

48. Section 16.2.3 on page 648, and Section 16.2.7 on page 661.

The existing mpi Fortran module must implement compile-time argument checking.

49. Section 16.2.2 on page 646.

Within the mpi_08 Fortran module, dummy arguments are declared with INTENT=IN,
 OUT, or INOUT as defined in the mpi_08 interfaces.

50. Section 16.2.7 on page 661.

This new section summarizes requirements that an MPI library together with a Fortran
 compiler is compliant to the MPI standard.

51. Section A.1.1, Table “Predefined functions” on page 722, Section A.1.3 on page 730,
 and Section A.3.4 on page 777.

Within the new mpi_f08 module, all callback prototype definitions are defined with
 explicit interfaces PROCEDURE(MPI_...) with BIND(C) attribute.

52. Section A.1.3 on page 730.

In some routines, the Fortran callback prototype names were changed from ..._FN to
 ..._FUNCTION to be consistent with the other language bindings.

1
 2 ticket251-V.
 3
 4 ticket245-Q.
 5
 6
 7
 8
 9
 10
 11 ticket237-I.
 12
 13
 14
 15 ticket238-J.
 16
 17
 18
 19
 20 ticket229.1.
 21
 22
 23
 24
 25 ticket233-E.
 26
 27 ticket232-D.
 28
 29
 30 ticket242-N.
 31
 32
 33
 34 ticket230-B.
 35 ticket231-C.
 36 ticket232-D.
 37 ticket234-F.
 38 ticket237-I.
 39 ticket238-J.
 40 ticket239-K.
 41 ticket233-O.
 42 ticket230-B.
 43 ticket250-V.
 44
 45
 46
 47
 48

B.2 TEST for Tickets 271, 168, 204, 280, 286, 287

This section is not part of the MPI standard and will be removed after the next meeting, July 2012.

The correctness of these interfaces must be verified!

```
MPI_Comm_dup_info(comm, info, newcomm, ierror) BIND(C)
```

```
    TYPE(MPI_Comm), INTENT(IN) :: comm
```

```
    TYPE(MPI_Info), INTENT(IN) :: info
```

```
    TYPE(MPI_Comm), INTENT(OUT) :: newcomm
```

```
    INTEGER, OPTIONAL, INTENT(OUT) :: ierror
```

```
MPI_COMM_DUP_INFO(COMM, INFO, NEWCOMM, IERROR)
```

```
    INTEGER COMM, INFO, NEWCOMM, IERROR
```

```
MPI_Comm_set_info(comm, info, ierror) BIND(C)
```

```
    TYPE(MPI_Comm), INTENT(IN) :: comm
```

```
    TYPE(MPI_Info), INTENT(IN) :: info
```

```
    INTEGER, OPTIONAL, INTENT(OUT) :: ierror
```

```
MPI_COMM_SET_INFO(COMM, INFO, IERROR)
```

```
    INTEGER COMM, INFO, IERROR
```

```
MPI_Comm_get_info(comm, info_used, ierror) BIND(C)
```

```
    TYPE(MPI_Comm), INTENT(IN) :: comm
```

```
    TYPE(MPI_Info), INTENT(OUT) :: info_used
```

```
    INTEGER, OPTIONAL, INTENT(OUT) :: ierror
```

```
MPI_COMM_GET_INFO(COMM, INFO_USED, IERROR)
```

```
    INTEGER COMM, INFO_USED, IERROR
```

```
MPI_Win_set_info(win, info, ierror) BIND(C)
```

```
    TYPE(MPI_Win), INTENT(IN) :: win
```

```
    TYPE(MPI_Info), INTENT(IN) :: info
```

```
    INTEGER, OPTIONAL, INTENT(OUT) :: ierror
```

```
MPI_WIN_SET_INFO(WIN, INFO, IERROR)
```

```
    INTEGER WIN, INFO, IERROR
```

```
MPI_Win_get_info(win, info_used, ierror) BIND(C)
```

```
    TYPE(MPI_Win), INTENT(IN) :: win
```

```
    TYPE(MPI_Info), INTENT(OUT) :: info_used
```

```
    INTEGER, OPTIONAL, INTENT(OUT) :: ierror
```

```
MPI_WIN_GET_INFO(WIN, INFO_USED, IERROR)
```

```
    INTEGER WIN, INFO_USED, IERROR
```

```
MPI_Comm_idup(comm, newcomm, request, ierror) BIND(C)
```

```
    TYPE(MPI_Comm), INTENT(IN) :: comm
```

```
    TYPE(MPI_Comm), ASYNCHRONOUS :: newcomm
```

```
    TYPE(MPI_Request), INTENT(OUT) :: request
```

```
    INTEGER, OPTIONAL, INTENT(OUT) :: ierror
```

```
MPI_COMM_IDUP(COMM, NEWCOMM, REQUEST, IERROR)
```

```

INTEGER COMM, NEWCOMM, REQUEST, IERROR
1
2 ticket-248T.
MPI_Get_library_version(version, resulten, ierror) BIND(C)
3
4 CHARACTER(LEN=MPI_MAX_LIBRARY_VERSION_STRING), INTENT(OUT) :: version
5
6 INTEGER, INTENT(OUT) :: resultlen
7
8 INTEGER, OPTIONAL, INTENT(OUT) :: ierror
9
MPI_GET_LIBRARY_VERSION(VERSION, RESULTEN, IERROR)
10
11 CHARACTER*(*) VERSION
12
13 INTEGER RESULTLEN, IERROR
14
15 MPI_Type_create_hindexed_block(count, blocklength, array_of_displacements,
16     oldtype, newtype, ierror) BIND(C)
17
18 INTEGER, INTENT(IN) :: count, blocklength
19
20 INTEGER(kind=MPI_Address_kind), INTENT(IN) ::
21 array_of_displacements(count)
22
23 TYPE(MPI_Datatype), INTENT(IN) :: oldtype
24
25 TYPE(MPI_Datatype), INTENT(OUT) :: newtype
26
27 INTEGER, OPTIONAL, INTENT(OUT) :: ierror
28
MPI_TYPE_CREATE_HINDEXED_BLOCK(COUNT, BLOCKLENGTH, ARRAY_OF_DISPLACEMENTS,
29     OLDTYPE, NEWTYPE, IERROR)
30
31 INTEGER COUNT, BLOCKLENGTH, OLDTYPE, NEWTYPE, IERROR
32
33 INTEGER(KIND=MPI_ADDRESS_KIND) ARRAY_OF_DISPLACEMENTS(*)
34
35 MPI_Comm_create_group(comm, group, tag, newcomm, ierror) BIND(C)
36
37 TYPE(MPI_Comm), INTENT(IN) :: comm
38
39 TYPE(MPI_Group), INTENT(IN) :: group
40
41 INTEGER, INTENT(IN) :: tag
42
43 TYPE(MPI_Comm), INTENT(OUT) :: newcomm
44
45 INTEGER, OPTIONAL, INTENT(OUT) :: ierror
46
MPI_COMM_CREATE_GROUP(COMM, GROUP, TAG, NEWCOMM, IERROR)
47
48 INTEGER COMM, GROUP, TAG, NEWCOMM, IERROR
49
50 MPI_Comm_split_type(comm, split_type, key, info, newcomm, ierror) BIND(C)
51
52 TYPE(MPI_Comm), INTENT(IN) :: comm
53
54 INTEGER, INTENT(IN) :: split_type, key
55
56 TYPE(MPI_Info), INTENT(IN) :: info
57
58 TYPE(MPI_Comm), INTENT(OUT) :: newcomm
59
60 INTEGER, OPTIONAL, INTENT(OUT) :: ierror
61
MPI_COMM_SPLIT_TYPE(COMM, SPLIT_TYPE, KEY, INFO, NEWCOMM, IERROR)
62
63 INTEGER COMM, SPLIT_TYPE, KEY, INFO, NEWCOMM, IERROR
64
65
66
67
68
69
70
71
72
73
74
75
76
77
78
79
80
81
82
83
84
85
86
87
88
89
90
91
92
93
94
95
96
97
98
99

```

B.3 Changes from Version 2.1 to Version 2.2

1. Section 2.5.4 on page 15.

It is now guaranteed that predefined named constant handles (as other constants) can be used in initialization expressions or assignments, i.e., also before the call to

1 MPI_INIT.

- 2
- 3 2. Section 2.6 on page 17, Section 2.6.4 on page 20, and Section 16.1 on page 631.
- 4 The C++ language bindings have been deprecated and may be removed in a future
- 5 version of the MPI specification.
- 6
- 7 3. Section 3.2.2 on page 29.
- 8 MPI_CHAR for printable characters is now defined for C type char (instead of signed
- 9 char). This change should not have any impact on applications nor on MPI libraries
- 10 (except some comment lines), because printable characters could and can be stored in
- 11 any of the C types char, signed char, and unsigned char, and MPI_CHAR is not allowed
- 12 for predefined reduction operations.
- 13
- 14 4. Section 3.2.2 on page 29.
- 15 MPI_(U)INT{8,16,32,64}_T, MPI_AINT, MPI_OFFSET, MPI_C_BOOL,
- 16 MPI_C_COMPLEX, MPI_C_FLOAT_COMPLEX, MPI_C_DOUBLE_COMPLEX, and
- 17 MPI_C_LONG_DOUBLE_COMPLEX are now valid predefined MPI datatypes.
- 18
- 19 5. Section 3.4 on page 41, Section 3.7.2 on page 54, Section 3.9 on page 80, and Section 5.1
- 20 on page 151.
- 21 The read access restriction on the send buffer for blocking, non blocking and collective
- 22 API has been lifted. It is permitted to access for read the send buffer while the
- 23 operation is in progress.
- 24
- 25 6. Section 3.7 on page 52.
- 26 The Advice to users for IBSEND and IRSEND was slightly changed.
- 27
- 28 7. Section 3.7.3 on page 58.
- 29 The advice to free an active request was removed in the Advice to users for
- 30 MPI_REQUEST_FREE.
- 31
- 32 8. Section 3.7.6 on page 70.
- 33 MPI_REQUEST_GET_STATUS changed to permit inactive or null requests as input.
- 34
- 35 9. Section 5.8 on page 180.
- 36 “In place” option is added to MPI_ALLTOALL, MPI_ALLTOALLV, and
- 37 MPI_ALLTOALLW for intracommunicators.
- 38
- 39 10. Section 5.9.2 on page 188.
- 40 Predefined parameterized datatypes (e.g., returned by
- 41 MPI_TYPE_CREATE_F90_REAL) and optional named predefined datatypes (e.g.
- 42 MPI_REAL8) have been added to the list of valid datatypes in reduction operations.
- 43
- 44 11. Section 5.9.2 on page 188.
- 45 MPI_(U)INT{8,16,32,64}_T are all considered C integer types for the purposes of the
- 46 predefined reduction operators. MPI_AINT and MPI_OFFSET are considered Fortran
- 47 integer types. MPI_C_BOOL is considered a Logical type.
- 48 MPI_C_COMPLEX, MPI_C_FLOAT_COMPLEX, MPI_C_DOUBLE_COMPLEX, and
- MPI_C_LONG_DOUBLE_COMPLEX are considered Complex types.
12. Section 5.9.7 on page 201.
- The local routines MPI_REDUCE_LOCAL and MPI_OP_COMMUTATIVE have been added.

13. Section 5.10.1 on page 203. 1
 The collective function MPI_REDUCE_SCATTER_BLOCK is added to the MPI standard. 2
3
14. Section 5.11.2 on page 207. 4
 Added in place argument to MPI_EXSCAN. 5
6
15. Section 6.4.2 on page 252, and Section 6.6 on page 268. 7
 Implementations that did not implement MPI_COMM_CREATE on intercommunicators will need to add that functionality. As the standard described the behavior of this operation on intercommunicators, it is believed that most implementations already provide this functionality. Note also that the C++ binding for both MPI_COMM_CREATE and MPI_COMM_SPLIT explicitly allow Intercomms. 8
9
10
11
12
13
16. Section 6.4.2 on page 252. 14
 MPI_COMM_CREATE is extended to allow several disjoint subgroups as input if comm is an intracommunicator. If comm is an intercommunicator it was clarified that all processes in the same local group of comm must specify the same value for group. 15
16
17
18
17. Section 7.5.4 on page 310. 19
 New functions for a scalable distributed graph topology interface has been added. In this section, the functions MPI_DIST_GRAPH_CREATE_ADJACENT and MPI_DIST_GRAPH_CREATE, the constants MPI_UNWEIGHTED, and the derived C++ class Distgraphcomm were added. 20
21
22
23
18. Section 7.5.5 on page 317. 24
 For the scalable distributed graph topology interface, the functions [25 ticket201.
 MPI_DIST_NEIGHBORS_COUNT]MPI_DIST_GRAPH_NEIGHBORS_COUNT and [26 ticket201.
 MPI_DIST_NEIGHBORS]MPI_DIST_GRAPH_NEIGHBORS and the constant 27
 MPI_DIST_GRAPH were added. 28
29
19. Section 7.5.5 on page 317. 30
 Remove ambiguity regarding duplicated neighbors with MPI_GRAPH_NEIGHBORS and MPI_GRAPH_NEIGHBORS_COUNT. 31
32
33
20. Section 8.1.1 on page 351. 34
 The subversion number changed from 1 to 2. 35
21. Section 8.3 on page 358, Section 15.2 on page 628, and Annex A.1.3 on page 730. 36
 Changed function pointer typedef names MPI_{Comm,File,Win}_errhandler_fn to MPI_{Comm,File,Win}_errhandler_function. Deprecated old “_fn” names. 37
38
39
22. Section 8.7.1 on page 380. 40
 Attribute deletion callbacks on MPI_COMM_SELF are now called in LIFO order. Implementors must now also register all implementation-internal attribute deletion callbacks on MPI_COMM_SELF before returning from MPI_INIT/MPI_INIT_THREAD. 41
42
43
44
23. Section 11.3.4 on page 443. 45
 The restriction added in MPI 2.1 that the operation MPI_REPLACE in MPI_ACCUMULATE can be used only with predefined datatypes has been removed. MPI_REPLACE can now be used even with derived datatypes, as it was in MPI 2.0. 46
47
48

Also, a clarification has been made that `MPI_REPLACE` can be used only in `MPI_ACCUMULATE`, not in collective operations that do reductions, such as `MPI_REDUCE` and others.

24. Section 12.2 on page 495.
Add “*” to the `query_fn`, `free_fn`, and `cancel_fn` arguments to the C++ binding for `MPI::Grequest::Start()` for consistency with the rest of MPI functions that take function pointer arguments.
25. Section 13.5.2 on page 562, and Table 13.2 on page 564.
`MPI_(U)INT{8,16,32,64}_T`, `MPI_AINT`, `MPI_OFFSET`, `MPI_C_COMPLEX`, `MPI_C_FLOAT_COMPLEX`, `MPI_C_DOUBLE_COMPLEX`, `MPI_C_LONG_DOUBLE_COMPLEX`, and `MPI_C_BOOL` are added as predefined datatypes in the external32 representation.
26. Section 16.3.7 on page 706.
The description was modified that it only describes how an MPI implementation behaves, but not how MPI stores attributes internally. The erroneous MPI-2.1 Example 16.17 was replaced with three new examples 16.25, 16.26, and 16.27 on pages 707-709 explicitly detailing cross-language attribute behavior. Implementations that matched the behavior of the old example will need to be updated.
27. Annex A.1.1 on page 713.
Removed type `MPI::Fint` (compare `MPI_Fint` in Section A.1.2 on page 729).
28. Annex A.1.1 on page 713. Table *Named Predefined Datatypes*.
Added `MPI_(U)INT{8,16,32,64}_T`, `MPI_AINT`, `MPI_OFFSET`, `MPI_C_BOOL`, `MPI_C_FLOAT_COMPLEX`, `MPI_C_COMPLEX`, `MPI_C_DOUBLE_COMPLEX`, and `MPI_C_LONG_DOUBLE_COMPLEX` are added as predefined datatypes.

B.4 Changes from Version 2.0 to Version 2.1

1. Section 3.2.2 on page 29, Section 16.1.6 on page 635, and Annex A.1 on page 713.
In addition, the `MPI_LONG_LONG` should be added as an optional type; it is a synonym for `MPI_LONG_LONG_INT`.
2. Section 3.2.2 on page 29, Section 16.1.6 on page 635, and Annex A.1 on page 713.
`MPI_LONG_LONG_INT`, `MPI_LONG_LONG` (as synonym), `MPI_UNSIGNED_LONG_LONG`, `MPI_SIGNED_CHAR`, and `MPI_WCHAR` are moved from optional to official and they are therefore defined for all three language bindings.
3. Section 3.2.5 on page 34.
`MPI_GET_COUNT` with zero-length datatypes: The value returned as the count argument of `MPI_GET_COUNT` for a datatype of length zero where zero bytes have been transferred is zero. If the number of bytes transferred is greater than zero, `MPI_UNDEFINED` is returned.
4. Section 4.1 on page 91.
General rule about derived datatypes: Most datatype constructors have replication count or block length arguments. Allowed values are non-negative integers. If the

value is zero, no elements are generated in the type map and there is no effect on datatype bounds or extent.

5. Section 4.3 on page 147.
MPI_BYTE should be used to send and receive data that is packed using MPI_PACK_EXTERNAL.
6. Section 5.9.6 on page 199.
If `comm` is an intercommunicator in MPI_ALLREDUCE, then both groups should provide `count` and `datatype` arguments that specify the same type signature (i.e., it is not necessary that both groups provide the same `count` value).
7. Section 6.3.1 on page 242.
MPI_GROUP_TRANSLATE_RANKS and MPI_PROC_NULL: MPI_PROC_NULL is a valid rank for input to MPI_GROUP_TRANSLATE_RANKS, which returns MPI_PROC_NULL as the translated rank.
8. Section 6.7 on page 277.
About the attribute caching functions:

Advice to implementors. High-quality implementations should raise an error when a keyval that was created by a call to MPI_XXX_CREATE_KEYVAL is used with an object of the wrong type with a call to MPI_YYY_GET_ATTR, MPI_YYY_SET_ATTR, MPI_YYY_DELETE_ATTR, or MPI_YYY_FREE_KEYVAL. To do so, it is necessary to maintain, with each keyval, information on the type of the associated user function. (*End of advice to implementors.*)
9. Section 6.8 on page 295.
In MPI_COMM_GET_NAME: In C, a null character is additionally stored at `name[resultlen]`. `resultlen` cannot be larger than `MPI_MAX_OBJECT_NAME-1`. In Fortran, `name` is padded on the right with blank characters. `resultlen` cannot be larger than `MPI_MAX_OBJECT_NAME`.
10. Section 7.4 on page 304.
About MPI_GRAPH_CREATE and MPI_CART_CREATE: All input arguments must have identical values on all processes of the group of `comm_old`.
11. Section 7.5.1 on page 306.
In MPI_CART_CREATE: If `ndims` is zero then a zero-dimensional Cartesian topology is created. The call is erroneous if it specifies a grid that is larger than the group size or if `ndims` is negative.
12. Section 7.5.3 on page 308.
In MPI_GRAPH_CREATE: If the graph is empty, i.e., `nnodes == 0`, then MPI_COMM_NULL is returned in all processes.
13. Section 7.5.3 on page 308.
In MPI_GRAPH_CREATE: A single process is allowed to be defined multiple times in the list of neighbors of a process (i.e., there may be multiple edges between two processes). A process is also allowed to be a neighbor to itself (i.e., a self loop in the graph). The adjacency matrix is allowed to be non-symmetric.

Advice to users. Performance implications of using multiple edges or a non-symmetric adjacency matrix are not defined. The definition of a node-neighbor edge does not imply a direction of the communication. (*End of advice to users.*)

14. Section 7.5.5 on page 317.
In `MPI_CARTDIM_GET` and `MPI_CART_GET`: If `comm` is associated with a zero-dimensional Cartesian topology, `MPI_CARTDIM_GET` returns `ndims=0` and `MPI_CART_GET` will keep all output arguments unchanged.
15. Section 7.5.5 on page 317.
In `MPI_CART_RANK`: If `comm` is associated with a zero-dimensional Cartesian topology, `coord` is not significant and 0 is returned in `rank`.
16. Section 7.5.5 on page 317.
In `MPI_CART_COORDS`: If `comm` is associated with a zero-dimensional Cartesian topology, `coords` will be unchanged.
17. Section 7.5.6 on page 325.
In `MPI_CART_SHIFT`: It is erroneous to call `MPI_CART_SHIFT` with a direction that is either negative or greater than or equal to the number of dimensions in the Cartesian communicator. This implies that it is erroneous to call `MPI_CART_SHIFT` with a `comm` that is associated with a zero-dimensional Cartesian topology.
18. Section 7.5.7 on page 327.
In `MPI_CART_SUB`: If all entries in `remain_dims` are false or `comm` is already associated with a zero-dimensional Cartesian topology then `newcomm` is associated with a zero-dimensional Cartesian topology.
- 18.1. Section 8.1.1 on page 351.
The subversion number changed from 0 to 1.
19. Section 8.1.2 on page 353.
In `MPI_GET_PROCESSOR_NAME`: In C, a null character is additionally stored at `name[resultlen]`. `resultlen` cannot be larger than `MPI_MAX_PROCESSOR_NAME-1`. In Fortran, `name` is padded on the right with blank characters. `resultlen` cannot be larger than `MPI_MAX_PROCESSOR_NAME`.
20. Section 8.3 on page 358.
`MPI_{COMM,WIN,FILE}_GET_ERRHANDLER` behave as if a new error handler object is created. That is, once the error handler is no longer needed, `MPI_ERRHANDLER_FREE` should be called with the error handler returned from `MPI_ERRHANDLER_GET` or `MPI_{COMM,WIN,FILE}_GET_ERRHANDLER` to mark the error handler for deallocation. This provides behavior similar to that of `MPI_COMM_GROUP` and `MPI_GROUP_FREE`.
21. Section 8.7 on page 375, see explanations to `MPI_FINALIZE`.
`MPI_FINALIZE` is collective over all connected processes. If no processes were spawned, accepted or connected then this means over `MPI_COMM_WORLD`; otherwise it is collective over the union of all processes that have been and continue to be connected, as explained in Section 10.5.4 on page 418.

22. Section 8.7 on page 375. 1
 About MPI_ABORT: 2
3
Advice to users. Whether the errorcode is returned from the executable or from 4
 the MPI process startup mechanism (e.g., mpiexec), is an aspect of quality of the 5
 MPI library but not mandatory. (*End of advice to users.*) 6
7
Advice to implementors. Where possible, a high-quality implementation will try 8
 to return the errorcode from the MPI process startup mechanism (e.g. mpiexec 9
 or singleton init). (*End of advice to implementors.*) 10
11
23. Section 9 on page 385. 12
 An implementation must support info objects as caches for arbitrary (key, value) 13
 pairs, regardless of whether it recognizes the key. Each function that takes hints in 14
 the form of an MPI_Info must be prepared to ignore any key it does not recognize. This 15
 description of info objects does not attempt to define how a particular function should 16
 react if it recognizes a key but not the associated value. MPI_INFO_GET_NKEYS, 17
 MPI_INFO_GET_NTHKEY, MPI_INFO_GET_VALUELEN, and MPI_INFO_GET must 18
 retain all (key,value) pairs so that layered functionality can also use the Info object. 19
24. Section 11.3 on page 437. 20
 MPI_PROC_NULL is a valid target rank in the MPI RMA calls MPI_ACCUMULATE, 21
 MPI_GET, and MPI_PUT. The effect is the same as for MPI_PROC_NULL in MPI point- 22
 to-point communication. See also item 25 in this list. 23
24
25. Section 11.3 on page 437. 25
 After any RMA operation with rank MPI_PROC_NULL, it is still necessary to finish 26
 the RMA epoch with the synchronization method that started the epoch. See also 27
 item 24 in this list. 28
29
26. Section 11.3.4 on page 443. 30
 MPI_REPLACE in MPI_ACCUMULATE, like the other predefined operations, is defined 31
 only for the predefined MPI datatypes. 32
27. Section 13.2.8 on page 523. 33
 About MPI_FILE_SET_VIEW and MPI_FILE_SET_INFO: When an info object that 34
 specifies a subset of valid hints is passed to MPI_FILE_SET_VIEW or 35
 MPI_FILE_SET_INFO, there will be no effect on previously set or defaulted hints that 36
 the info does not specify. 37
38
28. Section 13.2.8 on page 523. 39
 About MPI_FILE_GET_INFO: If no hint exists for the file associated with fh, a handle 40
 to a newly created info object is returned that contains no key/value pair. 41
42
29. Section 13.3 on page 526. 43
 If a file does not have the mode MPI_MODE_SEQUENTIAL, then 44
 MPI_DISPLACEMENT_CURRENT is invalid as disp in MPI_FILE_SET_VIEW. 45
30. Section 13.5.2 on page 562. 46
 The bias of 16 byte doubles was defined with 10383. The correct value is 16383. 47
48

1 31. Section [16.1.4](#) on page [632](#).

2 In the example in this section, the buffer should be declared as `const void* buf`.

3
4 32. Section [16.2.9](#) on page [664](#).

5 About `MPI_TYPE_CREATE_F90_XXXX`:

6 *Advice to implementors.* An application may often repeat a call to
7 `MPI_TYPE_CREATE_F90_XXXX` with the same combination of `(XXXX,p,r)`. The
8 application is not allowed to free the returned predefined, unnamed datatype
9 handles. To prevent the creation of a potentially huge amount of handles, the
10 MPI implementation should return the same datatype handle for the same (
11 `REAL/COMPLEX/INTEGER,p,r`) combination. Checking for the combination (
12 `p,r`) in the preceding call to `MPI_TYPE_CREATE_F90_XXXX` and using a hash-
13 table to find formerly generated handles should limit the overhead of finding
14 a previously generated datatype with same combination of `(XXXX,p,r)`. (*End of*
15 *advice to implementors.*)
16

17 33. Section [A.1.1](#) on page [713](#).

18 `MPI_BOTTOM` is defined as `void * const MPI::BOTTOM`.

1
2
3
4
5
6
7
8
9
10
11
12
13
14
15
16
17
18
19
20
21
22
23
24
25
26
27
28
29
30
31
32
33
34
35
36
37
38
39
40
41
42
43
44
45
46
47
48

Bibliography

- [1] V. Bala and S. Kipnis. Process groups: a mechanism for the coordination of and communication among processes in the Venus collective communication library. Technical report, IBM T. J. Watson Research Center, October 1992. Preprint. [1.2](#)
- [2] V. Bala, S. Kipnis, L. Rudolph, and Marc Snir. Designing efficient, scalable, and portable collective communication libraries. Technical report, IBM T. J. Watson Research Center, October 1992. Preprint. [1.2](#)
- [3] Purushotham V. Bangalore, Nathan E. Doss, and Anthony Skjellum. MPI++: Issues and Features. In *OON-SKI '94*, page in press, 1994. [6.1](#)
- [4] A. Beguelin, J. Dongarra, A. Geist, R. Manchek, and V. Sunderam. Visualization and debugging in a heterogeneous environment. *IEEE Computer*, 26(6):88–95, June 1993. [1.2](#)
- [5] Luc Bomans and Rolf Hempel. The Argonne/GMD macros in FORTRAN for portable parallel programming and their implementation on the Intel iPSC/2. *Parallel Computing*, 15:119–132, 1990. [1.2](#)
- [6] Dan Bonachea and Jason Duell. Problems with using MPI 1.1 and 2.0 as compilation targets for parallel language implementations. *IJHPCN*, 1(1/2/3):91–99, 2004. [11.7](#)
- [7] Rajesh Bordawekar, Juan Miguel del Rosario, and Alok Choudhary. Design and evaluation of primitives for parallel I/O. In *Proceedings of Supercomputing '93*, pages 452–461, 1993. [13.1](#)
- [8] R. Butler and E. Lusk. User’s guide to the p4 programming system. Technical Report TM-ANL-92/17, Argonne National Laboratory, 1992. [1.2](#)
- [9] Ralph Butler and Ewing Lusk. Monitors, messages, and clusters: The p4 parallel programming system. *Parallel Computing*, 20(4):547–564, April 1994. Also Argonne National Laboratory Mathematics and Computer Science Division preprint P362-0493. [1.2](#)
- [10] Robin Calkin, Rolf Hempel, Hans-Christian Hoppe, and Peter Wypior. Portable programming with the PARMACS message-passing library. *Parallel Computing*, 20(4):615–632, April 1994. [1.2](#)
- [11] S. Chittor and R. J. Enbody. Performance evaluation of mesh-connected wormhole-routed networks for interprocessor communication in multicomputers. In *Proceedings of the 1990 Supercomputing Conference*, pages 647–656, 1990. [7.1](#)

- 1 [12] S. Chittor and R. J. Enbody. Predicting the effect of mapping on the communi-
2 cation performance of large multicomputers. In *Proceedings of the 1991 International*
3 *Conference on Parallel Processing, vol. II (Software)*, pages II-1 – II-4, 1991. 7.1
- 4
5 [13] Parasoft Corporation. Express version 1.0: A communication environment for parallel
6 computers, 1988. 1.2, 7.4
- 7
8 [14] Juan Miguel del Rosario, Rajesh Bordawekar, and Alok Choudhary. Improved parallel
9 I/O via a two-phase run-time access strategy. In *IPPS '93 Workshop on Input/Output*
10 *in Parallel Computer Systems*, pages 56–70, 1993. Also published in *Computer Archi-*
11 *ture News* 21(5), December 1993, pages 31–38. 13.1
- 12 [15] J. Dongarra, A. Geist, R. Manchek, and V. Sunderam. Integrated PVM framework
13 supports heterogeneous network computing. *Computers in Physics*, 7(2):166–75, April
14 1993. 1.2
- 15
16 [16] J. J. Dongarra, R. Hempel, A. J. G. Hey, and D. W. Walker. A proposal for a user-
17 level, message passing interface in a distributed memory environment. Technical Report
18 TM-12231, Oak Ridge National Laboratory, February 1993. 1.2
- 19 [17] Edinburgh Parallel Computing Centre, University of Edinburgh. *CHIMP Concepts*,
20 June 1991. 1.2
- 21
22 [18] Edinburgh Parallel Computing Centre, University of Edinburgh. *CHIMP Version 1.0*
23 *Interface*, May 1992. 1.2
- 24
25 [19] Margaret A. Ellis and Bjarne Stroustrup. *The Annotated C++ Reference Manual*.
26 Addison Wesley, 1990.
- 27 [20] D. Feitelson. Communicators: Object-based multiparty interactions for parallel pro-
28 gramming. Technical Report 91-12, Dept. Computer Science, The Hebrew University
29 of Jerusalem, November 1991. 6.1.2
- 30
31 [21] C++ Forum. Working paper for draft proposed international standard for informa-
32 tion systems — programming language C++. Technical report, American National
33 Standards Institute, 1995.
- 34
35 [22] Message Passing Interface Forum. MPI: A Message-Passing Interface standard. *The In-*
36 *ternational Journal of Supercomputer Applications and High Performance Computing*,
37 8, 1994. 1.3
- 38 [23] Message Passing Interface Forum. MPI: A Message-Passing Interface standard (version
39 1.1). Technical report, 1995. <http://www.mpi-forum.org>. 1.3
- 40
41 [24] Al Geist, Adam Beguelin, Jack Dongarra, Weicheng Jiang, Bob Manchek, and Vaidy
42 Sunderam. *PVM: Parallel Virtual Machine—A User's Guide and Tutorial for Network*
43 *Parallel Computing*. MIT Press, 1994. 10.1
- 44
45 [25] G. A. Geist, M. T. Heath, B. W. Peyton, and P. H. Worley. PICL: A portable in-
46 strumented communications library, C reference manual. Technical Report TM-11130,
47 Oak Ridge National Laboratory, Oak Ridge, TN, July 1990. 1.2
- 48

- [26] D. Gregor, T. Hoefler, B. Barrett, and A. Lumsdaine. Fixing Probe for Multi-Threaded MPI Applications. Technical Report 674, Indiana University, Jan. 2009. [3.8.2](#)
- [27] William D. Gropp and Barry Smith. Chameleon parallel programming tools users manual. Technical Report ANL-93/23, Argonne National Laboratory, March 1993. [1.2](#)
- [28] Michael Hennecke. A Fortran 90 interface to MPI version 1.1. Technical Report Internal Report 63/96, Rechenzentrum, Universität Karlsruhe, D-76128 Karlsruhe, Germany, June 1996. Available via world wide web from http://www.uni-karlsruhe.de/~Michael.Hennecke/Publications/#MPI_F90. [16.2.3](#), [16.2.3](#)
- [29] T. Hoefler, G. Bronevetsky, B. Barrett, B. R. de Supinski, and A. Lumsdaine. Efficient MPI Support for Advanced Hybrid Programming Models. In *Recent Advances in the Message Passing Interface (EuroMPI'10)*, volume LNCS 6305, pages 50–61. Springer, Sep. 2010. [3.8](#), [3.8.2](#)
- [30] T. Hoefler, P. Gottschling, A. Lumsdaine, and W. Rehm. Optimizing a Conjugate Gradient Solver with Non-Blocking Collective Operations. *Elsevier Journal of Parallel Computing (PARCO)*, 33(9):624–633, Sep. 2007. [5.12](#)
- [31] T. Hoefler, F. Lorenzen, and A. Lumsdaine. Sparse Non-Blocking Collectives in Quantum Mechanical Calculations. In *Recent Advances in Parallel Virtual Machine and Message Passing Interface, 15th European PVM/MPI Users' Group Meeting*, volume LNCS 5205, pages 55–63. Springer, Sep. 2008. [7.6](#)
- [32] T. Hoefler and A. Lumsdaine. Message Progression in Parallel Computing - To Thread or not to Thread? In *Proceedings of the 2008 IEEE International Conference on Cluster Computing*. IEEE Computer Society, Oct. 2008. [5.12](#)
- [33] T. Hoefler, A. Lumsdaine, and W. Rehm. Implementation and Performance Analysis of Non-Blocking Collective Operations for MPI. In *Proceedings of the 2007 International Conference on High Performance Computing, Networking, Storage and Analysis, SC07*. IEEE Computer Society/ACM, Nov. 2007. [5.12](#)
- [34] T. Hoefler, M. Schellmann, S. Gorchatch, and A. Lumsdaine. Communication Optimization for Medical Image Reconstruction Algorithms. In *Recent Advances in Parallel Virtual Machine and Message Passing Interface, 15th European PVM/MPI Users' Group Meeting*, volume LNCS 5205, pages 75–83. Springer, Sep. 2008. [5.12](#)
- [35] T. Hoefler and J. L. Traeff. Sparse Collective Operations for MPI. In *Proceedings of the 23rd IEEE International Parallel & Distributed Processing Symposium, HIPS'09 Workshop*, May 2009. [7.6](#)
- [36] Institute of Electrical and Electronics Engineers, New York. *IEEE Standard for Binary Floating-Point Arithmetic, ANSI/IEEE Standard 754-1985*, 1985. [13.5.2](#)
- [37] International Organization for Standardization, Geneva, ISO 8859-1:1987. *Information processing — 8-bit single-byte coded graphic character sets — Part 1: Latin alphabet No. 1*, 1987. [13.5.2](#)

- [38] International Organization for Standardization, Geneva, ISO/IEC 9945-1:1996(E). *Information technology — Portable Operating System Interface (POSIX) — Part 1: System Application Program Interface (API) [C Language]*, December 1996. [12.4](#), [13.2.1](#)
- [39] International Organization for Standardization, Geneva, ISO/IEC 1539-1:2010. *Information technology – Programming languages – Fortran – Part 1: Base language*, November 2010. [16.2.1](#), [16.2.2](#)
- [40] International Organization for Standardization, ISO/IEC/SC22/WG5 (Fortran), Geneva, TR 29113, Draft N1869. *TR on further interoperability with C*, July, 18 2011. <http://www.nag.co.uk/sc22wg5/> and <ftp://ftp.nag.co.uk/sc22wg5/N1851-N1900/N1869.pdf>. [16.2.2](#)
- [41] International Organization for Standardization, ISO/IEC/SC22/WG5 (Fortran), Geneva, TR 29113. *TR on further interoperability with C*, 2012. <http://www.nag.co.uk/sc22wg5/>. [16.2.1](#), [16.2.1](#), [16.2.2](#), [16.2.7](#), [37](#)
- [42] Charles H. Koelbel, David B. Loveman, Robert S. Schreiber, Guy L. Steele Jr., and Mary E. Zosel. *The High Performance Fortran Handbook*. MIT Press, 1993. [4.1.4](#)
- [43] David Kotz. Disk-directed I/O for MIMD multiprocessors. In *Proceedings of the 1994 Symposium on Operating Systems Design and Implementation*, pages 61–74, November 1994. Updated as Dartmouth TR PCS-TR94-226 on November 8, 1994. [13.1](#)
- [44] O. Krämer and H. Mühlenbein. Mapping strategies in message-based multiprocessor systems. *Parallel Computing*, 9:213–225, 1989. [7.1](#)
- [45] S. J. Lefflet, R. S. Fabry, W. N. Joy, P. Lapsley, S. Miller, and C. Torek. An advanced 4.4BSD interprocess communication tutorial, Unix programmer’s supplementary documents (PSD) 21. Technical report, Computer Systems Research Group, Department of Electrical Engineering and Computer Science, University of California, Berkeley, 1993. Also available at <http://www.netbsd.org/Documentation/lite2/psd/>. [10.5.5](#)
- [46] nCUBE Corporation. *nCUBE 2 Programmers Guide, r2.0*, December 1990. [1.2](#)
- [47] Bill Nitzberg. Performance of the iPSC/860 Concurrent File System. Technical Report RND-92-020, NAS Systems Division, NASA Ames, December 1992. [13.1](#)
- [48] William J. Nitzberg. *Collective Parallel I/O*. PhD thesis, Department of Computer and Information Science, University of Oregon, December 1995. [13.1](#)
- [49] *4.4BSD Programmer’s Supplementary Documents (PSD)*. O’Reilly and Associates, 1994. [10.5.5](#)
- [50] Paul Pierce. The NX/2 operating system. In *Proceedings of the Third Conference on Hypercube Concurrent Computers and Applications*, pages 384–390. ACM Press, 1988. [1.2](#)
- [51] Martin Schulz and Bronis R. de Supinski. P^NMPI Tools: A Whole Lot Greater Than the Sum of Their Parts. In *ACM/IEEE Supercomputing Conference (SC)*, pages 1–10. ACM, 2007. [14.2.8](#)

- [52] K. E. Seamons, Y. Chen, P. Jones, J. Jozwiak, and M. Winslett. Server-directed collective I/O in Panda. In *Proceedings of Supercomputing '95*, December 1995. [13.1](#)
- [53] A. Skjellum and A. Leung. Zipcode: a portable multicomputer communication library atop the reactive kernel. In D. W. Walker and Q. F. Stout, editors, *Proceedings of the Fifth Distributed Memory Concurrent Computing Conference*, pages 767–776. IEEE Press, 1990. [1.2](#), [6.1.2](#)
- [54] A. Skjellum, S. Smith, C. Still, A. Leung, and M. Morari. The Zipcode message passing system. Technical report, Lawrence Livermore National Laboratory, September 1992. [1.2](#)
- [55] Anthony Skjellum, Nathan E. Doss, and Purushotham V. Bangalore. Writing Libraries in MPI. In Anthony Skjellum and Donna S. Reese, editors, *Proceedings of the Scalable Parallel Libraries Conference*, pages 166–173. IEEE Computer Society Press, October 1993. [6.1](#)
- [56] Anthony Skjellum, Nathan E. Doss, and Kishore Viswanathan. Inter-communicator extensions to MPI in the MPIX (MPI eXtension) Library. Technical Report MSU-940722, Mississippi State University — Dept. of Computer Science, April 1994. <http://www.erc.msstate.edu/mpi/mpix.html>. [5.2.2](#)
- [57] Anthony Skjellum, Ziyang Lu, Purushotham V. Bangalore, and Nathan E. Doss. Explicit parallel programming in C++ based on the message-passing interface (MPI). In Gregory V. Wilson, editor, *Parallel Programming Using C++*, Engineering Computation Series. MIT Press, July 1996. ISBN 0-262-73118-5.
- [58] Anthony Skjellum, Steven G. Smith, Nathan E. Doss, Alvin P. Leung, and Manfred Morari. The Design and Evolution of Zipcode. *Parallel Computing*, 20(4):565–596, April 1994. [6.1.2](#), [6.5.6](#)
- [59] Rajeev Thakur and Alok Choudhary. An Extended Two-Phase Method for Accessing Sections of Out-of-Core Arrays. *Scientific Programming*, 5(4):301–317, Winter 1996. [13.1](#)
- [60] *The Unicode Standard, Version 2.0*. Addison-Wesley, 1996. ISBN 0-201-48345-9. [13.5.2](#)
- [61] D. Walker. Standards for message passing in a distributed memory environment. Technical Report TM-12147, Oak Ridge National Laboratory, August 1992. [1.2](#)

Examples Index

This index lists code examples throughout the text. Some examples are referred to by content; others are listed by the major MPI function that they are demonstrating. MPI functions listed in all capital letter are Fortran examples; MPI functions listed in mixed case are C/C++ examples.

ASYNCHRONOUS, [685](#), [694](#)

Attributes between languages, [707](#)

Basic tool using performance variables in the MPI tool information interface, [614](#)

C++ communicator handle initialization, [639](#)

C++ declarations in `mpi.h`, [642](#)

C++ deriving from C++ MPI class, [633](#)

C++ handle assignment and comparison operators, [639](#)

C++ handle assignment operator, [634](#)

C++ handle scope destruction, [634](#)

C++ MPI class comparison operator, [633](#)

C++ profiling example, [643](#), [644](#)

C/C++ handle conversion, [699](#), [700](#)

C/Fortran handle conversion, [698](#)

Cartesian virtual topologies, [345](#)

Client-server code, [69](#), [70](#)

with blocking probe, [73](#)

with blocking probe, wrong, [73](#)

Datatype

3D array, [131](#)

absolute addresses, [137](#)

array of structures, [134](#)

elaborate example, [145](#), [146](#)

matching type, [120](#)

matrix transpose, [132](#), [133](#)

union, [138](#)

Datatypes

matching, [38](#)

not matching, [38](#)

untyped, [39](#)

Deadlock

if not buffered, [48](#)

with MPI_Bcast, [228](#), [229](#)

wrong message exchange, [48](#)

False matching of collective operations, [232](#)

Fortran 90 KIND, [667](#)

Fortran 90 copying and sequence problem, [675](#), [677](#), [678](#)

Fortran 90 derived types, [679](#)

Fortran 90 heterogeneous communication, [671](#), [672](#)

Fortran 90 MPI_TYPE_MATCH_SIZE implementation, [671](#)

Fortran 90 overlapping communication and computation, [690](#), [691](#), [695](#)

Fortran 90 register optimization, [682–684](#)

Independence of nonblocking operations, [235](#)

Intercommunicator, [255](#), [258](#)

Interlanguage communication, [711](#)

Intertwined matching pairs, [46](#)

Message exchange, [48](#)

Mixing blocking and nonblocking collective operations, [231](#)

Mixing collective and point-to-point requests, [234](#)

MPI::Comm::Probe, [37](#)

MPI_ACCUMULATE, [445](#)

MPI_Accumulate, [489](#), [491](#)

MPI_ADDRESS, [111](#)

MPI_Address, [134](#), [137](#), [138](#), [145](#)

MPI_Aint, 134	
MPI_Allgather, 179	
MPI_ALLOC_MEM, 357	
MPI_Alloc_mem, 358, 491	
MPI_ALLREDUCE, 200	
MPI_Alltoall, 233	
MPI_Barrier, 377, 478–481, 487, 489, 490	
MPI_Bcast, 159, 213, 228–232	
MPI_BSEND, 46	
MPI_Buffer_attach, 50, 377	
MPI_Buffer_detach, 50	
MPI_BYTE, 39	
MPI_Cancel, 377	
MPI_CART_COORDS, 326	
MPI_CART_GET, 345	
MPI_CART_RANK, 326, 345	
MPI_CART_SHIFT, 326, 345	
MPI_CART_SUB, 327	
MPI_CHARACTER, 39	
MPI_Comm_create, 255	
MPI_Comm_group, 255	
MPI_Comm_remote_size, 258	
MPI_COMM_SPAWN, 396	
MPI_Comm_spawn, 396	
MPI_COMM_SPAWN_MULTIPLE, 402	
MPI_Comm_spawn_multiple, 402	
MPI_Comm_split, 258	
MPI_Compare_and_swap, 490, 491	
MPI_DIMS_CREATE, 308, 345	
MPI_DIST_GRAPH_CREATE, 315	
MPI_Dist_graph_create, 316	
MPI_DIST_GRAPH_CREATE_ADJACENT, 315	
MPI_FILE_CLOSE, 537, 541	
MPI_FILE_GET_AMODE, 522	
MPI_FILE_IREAD, 541	
MPI_FILE_OPEN, 537, 541	
MPI_FILE_READ, 537	
MPI_FILE_SET_ATOMICITY, 574	
MPI_FILE_SET_VIEW, 537, 541	
MPI_FILE_SYNC, 575	
MPI_Finalize, 377, 378	
MPI_FREE_MEM, 357	
MPI_Free_mem, 491	
MPI_Gather, 146, 163, 164, 169	
MPI_Gatherv, 146, 165–169	
MPI_GET, 441, 443	
MPI_Get, 478–480, 486, 487	
MPI_Get_accumulate, 489, 491	1
MPI_GET_ADDRESS, 111, 679, 680, 703	2
MPI_Get_address, 134, 137, 138, 145	3
MPI_GET_COUNT, 122	4
MPI_GET_ELEMENTS, 122	5
MPI_GRAPH_CREATE, 309, 322	6
MPI_GRAPH_NEIGHBORS, 322	7
MPI_GRAPH_NEIGHBORS_COUNT, 322	8
MPI_Grequest_complete, 500	9
MPI_Grequest_start, 500	10
MPI_Group_free, 255	11
MPI_Group_incl, 255	12
MPI_Iallreduce, 234	13
MPI_Ialltoall, 233	14
MPI_Ibarrier, 231–234	15
MPI_Ibcast, 234, 235	16
MPI_Iprobe, 377	17
MPI_IRECV, 60–62, 69, 70	18
MPI_Irecv, 234	19
MPI_ISEND, 60–62, 69, 70	20
MPI_Op_create, 198, 199, 208	21
MPI_Pack, 144–146	22
MPI_Pack_size, 146	23
MPI_PROBE, 73	24
MPI_Put, 462, 468, 479–481, 486, 487	25
MPI_RECV, 38, 39, 46, 48, 62, 73, 120	26
MPI_Recv, 233	27
MPI_REDUCE, 189, 190, 193	28
MPI_Reduce, 192, 194, 198, 199	29
MPI_REQUEST_FREE, 61	30
MPI_Request_free, 377	31
MPI_Rget, 490	32
MPI_Rput, 490	33
MPI_Scan, 208	34
MPI_Scatter, 173	35
MPI_Scatterv, 174	36
MPI_SEND, 38, 39, 48, 62, 73, 120	37
MPI_Send, 134, 137, 138, 145, 233, 234	38
MPI_SENDRECV, 131–133	39
MPI_SENDRECV_REPLACE, 326	40
MPI_SSEND, 46, 62	41
MPI_Test_cancelled, 377	42
MPI_TYPE_COMMIT, 118, 131–133, 441, 679, 680	43
MPI_Type_commit, 134, 137, 138, 145, 164–169, 174, 208	44
	45
	46
	47
	48

- 1 MPI_TYPE_CONTIGUOUS, [94](#), [113](#), [120](#),
- 2 [122](#)
- 3 MPI_Type_contiguous, [164](#)
- 4 MPI_TYPE_CREATE_DARRAY, [110](#)
- 5 MPI_TYPE_CREATE_HVECTOR, [131](#),
- 6 [132](#)
- 7 MPI_Type_create_hvector, [134](#), [137](#)
- 8 MPI_TYPE_CREATE_INDEXED_BLOCK,
- 9 [441](#)
- 10 MPI_TYPE_CREATE_RESIZED, [679](#),
- 11 [680](#)
- 12 MPI_TYPE_CREATE_STRUCT, [102](#),
- 13 [113](#), [133](#), [679](#), [680](#)
- 14 MPI_Type_create_struct, [134](#), [137](#), [138](#),
- 15 [145](#), [167](#), [169](#), [208](#)
- 16 MPI_TYPE_CREATE_SUBARRAY, [582](#)
- 17 MPI_TYPE_EXTENT, [131–133](#), [441](#)
- 18 MPI_Type_extent, [134](#)
- 19 MPI_TYPE_FREE, [441](#)
- 20 MPI_Type_get_contents, [139](#)
- 21 MPI_Type_get_envelope, [139](#)
- 22 MPI_TYPE_GET_EXTENT, [443](#), [445](#)
- 23 MPI_TYPE_HVECTOR, [131](#), [132](#)
- 24 MPI_Type_hvector, [134](#), [137](#)
- 25 MPI_TYPE_INDEXED, [98](#), [132](#)
- 26 MPI_Type_indexed, [134](#), [137](#)
- 27 MPI_TYPE_STRUCT, [102](#), [113](#), [133](#)
- 28 MPI_Type_struct, [134](#), [137](#), [138](#), [145](#), [167](#),
- 29 [169](#), [208](#)
- 30 MPI_TYPE_VECTOR, [95](#), [131–133](#)
- 31 MPI_Type_vector, [165](#), [166](#), [168](#), [174](#)
- 32 MPI_Unpack, [145](#), [146](#)
- 33 MPI_User_function, [199](#)
- 34 MPI_WAIT, [60–62](#), [69](#), [70](#), [541](#)
- 35 MPI_Wait, [231–234](#)
- 36 MPI_Waitall, [234](#), [490](#)
- 37 MPI_WAITANY, [69](#)
- 38 MPI_Waitany, [490](#)
- 39 MPI_WAITSOME, [70](#)
- 40 MPI_Win_attach, [491](#)
- 41 MPI_Win_complete, [462](#), [480](#), [481](#), [487](#)
- 42 MPI_WIN_CREATE, [441](#), [443](#), [445](#)
- 43 MPI_Win_create_dynamic, [491](#)
- 44 MPI_Win_detach, [491](#)
- 45 MPI_WIN_FENCE, [441](#), [443](#), [445](#)
- 46 MPI_Win_fence, [486](#)
- 47 MPI_Win_flush, [480](#), [489–491](#)
- 48 MPI_Win_flush_all, [489](#)
- MPI_Win_flush_local, [479](#)
- MPI_WIN_FREE, [443](#), [445](#)
- MPI_Win_lock, [468](#), [478–481](#)
- MPI_Win_lock_all, [490](#), [491](#)
- MPI_Win_post, [480](#), [481](#), [487](#)
- MPI_Win_start, [462](#), [480](#), [481](#), [487](#)
- MPI_Win_sync, [479](#), [480](#), [489](#), [490](#)
- MPI_Win_unlock, [468](#), [478–481](#)
- MPI_Win_unlock_all, [490](#), [491](#)
- MPI_Win_wait, [480](#), [481](#), [487](#)
- mpiexec, [383](#)
- Neighborhood collective communication, [345](#)
- No Matching of Blocking and Nonblocking collective operations, [233](#)
- Non-deterministic program with MPI_Bcast, [230](#)
- Non-overtaking messages, [46](#)
- Nonblocking operations, [60](#), [61](#)
message ordering, [62](#)
progress, [62](#)
- Overlapping Communicators, [234](#)
- Pipelining nonblocking collective operations, [234](#)
- Profiling interface, [589](#)
- Progression of nonblocking collective operations, [233](#)
- Reading the value of a control variable in the MPI tool information interface, [603](#)
- Threads and MPI, [505](#)
- Topologies, [345](#)
- Typemap, [93–95](#), [98](#), [102](#), [110](#)
- Using MPI_T_CVAR_GET_INFO to list all names of control variables., [600](#)
- Virtual topologies, [345](#)

MPI Constant and Predefined Handle Index

This index lists predefined MPI constants and handles.

MPI::*_NULL, [633](#)
MPI::_LONG_LONG, [635](#), [861](#)
MPI::ANY_SOURCE, [715](#)
MPI::ANY_TAG, [715](#)
MPI::APPNUM, [724](#)
MPI::ARGV_NULL, [727](#)
MPI::ARGVS_NULL, [727](#)
MPI::BAND, [720](#)
MPI::BOOL, [636](#), [638](#), [718](#), [865](#)
MPI::BOR, [720](#)
MPI::BOTTOM, [715](#)
MPI::BSEND_OVERHEAD, [715](#)
MPI::BXOR, [720](#)
MPI::BYTE, [635](#), [636](#), [638](#), [717](#), [718](#)
MPI::CART, [722](#)
MPI::CHAR, [636](#), [717](#)
MPI::CHARACTER, [636](#), [718](#)
MPI::COMBINER_CONTIGUOUS, [725](#)
MPI::COMBINER_DARRAY, [725](#)
MPI::COMBINER_DUP, [725](#)
MPI::COMBINER_F90_COMPLEX, [725](#)
MPI::COMBINER_F90_INTEGER, [725](#)
MPI::COMBINER_F90_REAL, [725](#)
MPI::COMBINER_HINDEXED, [725](#)
MPI::COMBINER_HINDEXED_INTEGER, [725](#)
MPI::COMBINER_HVECTOR, [725](#)
MPI::COMBINER_HVECTOR_INTEGER, [725](#)
MPI::COMBINER_INDEXED, [725](#)
MPI::COMBINER_INDEXED_BLOCK, [725](#)
MPI::COMBINER_NAMED, [725](#)
MPI::COMBINER_RESIZED, [725](#)
MPI::COMBINER_STRUCT, [725](#)
MPI::COMBINER_STRUCT_INTEGER, [725](#)
MPI::COMBINER_SUBARRAY, [725](#)
MPI::COMBINER_VECTOR, [725](#)
MPI::COMM_NULL, [635](#), [639](#), [721](#)
MPI::COMM_SELF, [719](#)
MPI::COMM_WORLD, [719](#)
MPI::COMPLEX, [636](#), [638](#), [718](#), [865](#)
MPI::CONGRUENT, [720](#)
MPI::DATATYPE_NULL, [721](#)
MPI::DISPLACEMENT_CURRENT, [726](#)
MPI::DIST_GRAPH, [722](#)
MPI::DISTRIBUTE_BLOCK, [726](#)
MPI::DISTRIBUTE_CYCLIC, [726](#)
MPI::DISTRIBUTE_DFLT_DARG, [726](#)
MPI::DISTRIBUTE_NONE, [726](#)
MPI::DOUBLE, [636](#), [638](#), [717](#)
MPI::DOUBLE_COMPLEX, [636](#), [638](#), [718](#), [865](#)
MPI::DOUBLE_INT, [637](#), [719](#)
MPI::DOUBLE_PRECISION, [636](#), [638](#), [718](#)
MPI::DUP_FN, [724](#)
MPI::ERR_ACCESS, [714](#)
MPI::ERR_AMODE, [714](#)
MPI::ERR_ARG, [713](#)
MPI::ERR_ASSERT, [714](#)
MPI::ERR_BAD_FILE, [714](#)
MPI::ERR_BASE, [714](#)
MPI::ERR_BUFFER, [713](#)
MPI::ERR_COMM, [713](#)
MPI::ERR_CONVERSION, [714](#)
MPI::ERR_COUNT, [713](#)
MPI::ERR_DIMS, [713](#)
MPI::ERR_DISP, [714](#)

1	MPI::ERR_DUP_DATAREP, 714	MPI::ERRORS_THROW_EXCEPTIONS,
2	MPI::ERR_FILE, 714	21, 24, 359, 716
3	MPI::ERR_FILE_EXISTS, 714	MPI::F_COMPLEX, 636, 638, 718
4	MPI::ERR_FILE_IN_USE, 714	MPI::F_COMPLEX16, 637, 638, 718, 861
5	MPI::ERR_GROUP, 713	MPI::F_COMPLEX32, 637, 638, 718, 861
6	MPI::ERR_IN_STATUS, 714	MPI::F_COMPLEX4, 637, 638, 718, 861
7	MPI::ERR_INFO, 714	MPI::F_COMPLEX8, 637, 638, 718, 861
8	MPI::ERR_INFO_KEY, 714	MPI::F_DOUBLE_COMPLEX, 637, 638,
9	MPI::ERR_INFO_NOKEY, 714	718
10	MPI::ERR_INFO_VALUE, 714	MPI::FILE_NULL, 721
11	MPI::ERR_INTERN, 713	MPI::FLOAT, 636, 638, 717
12	MPI::ERR_IO, 714	MPI::FLOAT_INT, 637, 719
13	MPI::ERR_KEYVAL, 714	MPI::GRAPH, 722
14	MPI::ERR_LASTCODE, 714	MPI::GROUP_EMPTY, 721
15	MPI::ERR_LOCKTYPE, 714	MPI::GROUP_NULL, 721
16	MPI::ERR_NAME, 714	MPI::HOST, 720
17	MPI::ERR_NO_MEM, 714	MPI::IDENT, 720
18	MPI::ERR_NO_SPACE, 714	MPI::IN_PLACE, 715
19	MPI::ERR_NO_SUCH_FILE, 714	MPI::INFO_NULL, 721
20	MPI::ERR_NOT_SAME, 714	MPI::INT, 635, 636, 717
21	MPI::ERR_OP, 713	MPI::INTEGER, 635, 636, 718
22	MPI::ERR_OTHER, 713	MPI::INTEGER1, 637, 638, 718
23	MPI::ERR_PENDING, 713	MPI::INTEGER16, 637, 638, 718, 861
24	MPI::ERR_PORT, 714	MPI::INTEGER2, 637, 638, 718
25	MPI::ERR_QUOTA, 714	MPI::INTEGER4, 637, 638, 718
26	MPI::ERR_RANK, 713	MPI::INTEGER8, 637, 638, 718
27	MPI::ERR_READ_ONLY, 714	MPI::IO, 720
28	MPI::ERR_REQUEST, 713	MPI::KEYVAL_INVALID, 715
29	MPI::ERR_RMA_CONFLICT, 714	MPI::LAND, 720
30	MPI::ERR_RMA_SYNC, 714	MPI::LASTUSED_CODE, 724
31	MPI::ERR_ROOT, 713	MPI::LB, 719
32	MPI::ERR_SERVICE, 714	MPI::LOCK_EXCLUSIVE, 715
33	MPI::ERR_SIZE, 714	MPI::LOCK_SHARED, 715
34	MPI::ERR_SPAWN, 714	MPI::LOGICAL, 636, 638, 718
35	MPI::ERR_TAG, 713	MPI::LONG, 635, 636, 717
36	MPI::ERR_TOPOLOGY, 713	MPI::LONG_DOUBLE, 636, 638, 717
37	MPI::ERR_TRUNCATE, 713	MPI::LONG_DOUBLE_COMPLEX, 636,
38	MPI::ERR_TYPE, 713	638, 718, 865
39	MPI::ERR_UNKNOWN, 713	MPI::LONG_DOUBLE_INT, 637, 719
40	MPI::ERR_UNSUPPORTED_DATAREP,	MPI::LONG_INT, 637, 719
41	714	MPI::LONG_LONG, 636, 717, 861
42	MPI::ERR_UNSUPPORTED_OPERATION,	MPI::LONG_LONG_INT, 717
43	714	MPI::LOR, 720
44	MPI::ERR_WIN, 714	MPI::LXOR, 720
45	MPI::ERRHANDLER_NULL, 721	MPI::MAX, 720
46	MPI::ERRORS_ARE_FATAL, 21, 716	MPI::MAX_DATAREP_STRING, 716
47	MPI::ERRORS_RETURN, 21, 716	MPI::MAX_ERROR_STRING, 716
48		MPI::MAX_INFO_KEY, 716

MPI::MAX_INFO_VAL, 716	MPI::THREAD_MULTIPLE, 726	1
MPI::MAX_OBJECT_NAME, 716	MPI::THREAD_SERIALIZED, 726	2
MPI::MAX_PORT_NAME, 716	MPI::THREAD_SINGLE, 726	3
MPI::MAX_PROCESSOR_NAME, 716	MPI::TWODOUBLE_PRECISION, 637,	4
MPI::MAXLOC, 638, 720	719	5
MPI::MIN, 720	MPI::TWOINT, 637, 719	6
MPI::MINLOC, 638, 720	MPI::TWOINTEGER, 637, 719	7
MPI::MODE_APPEND, 725	MPI::TWOREAL, 637, 719	8
MPI::MODE_CREATE, 725	MPI::TYPECLASS_COMPLEX, 726	9
MPI::MODE_DELETE_ON_CLOSE, 725	MPI::TYPECLASS_INTEGER, 726	10
MPI::MODE_EXCL, 725	MPI::TYPECLASS_REAL, 726	11
MPI::MODE_NOCHECK, 725	MPI::UB, 719	12
MPI::MODE_NOPRECEDE, 725	MPI::UNDEFINED, 715	13
MPI::MODE_NOPUT, 725	MPI::UNEQUAL, 720	14
MPI::MODE_NOSTORE, 725	MPI::UNIVERSE_SIZE, 724	15
MPI::MODE_NOSUCCEED, 725	MPI::UNSIGNED, 635, 636, 717	16
MPI::MODE_RDONLY, 725	MPI::UNSIGNED_CHAR, 635, 636, 717	17
MPI::MODE_RDWR, 725	MPI::UNSIGNED_LONG, 635, 636, 717	18
MPI::MODE_SEQUENTIAL, 725	MPI::UNSIGNED_LONG_LONG, 635,	19
MPI::MODE_UNIQUE_OPEN, 725	636, 717	20
MPI::MODE_WRONLY, 725	MPI::UNSIGNED_SHORT, 635, 636, 717	21
MPI::NULL_COPY_FN, 724	MPI::WCHAR, 636, 717	22
MPI::NULL_DELETE_FN, 724	MPI::WIN_BASE, 724	23
MPI::OP_NULL, 721	MPI::WIN_DISP_UNIT, 724	24
MPI::ORDER_C, 726	MPI::WIN_NULL, 721	25
MPI::ORDER_FORTRAN, 726	MPI::WIN_SIZE, 724	26
MPI::PACKED, 635, 636, 717, 718	MPI::WTIME_IS_GLOBAL, 720	27
MPI::PROC_NULL, 715	MPI_2DOUBLE_PRECISION, 192, 719	28
MPI::PROD, 720	MPI_2INT, 192, 719	29
MPI::REAL, 636, 638, 718	MPI_2INTEGER, 192, 719	30
MPI::REAL16, 637, 638, 718, 861	MPI_2REAL, 192, 719	31
MPI::REAL2, 637, 638, 718	MPI_ADDRESS_KIND, 16, 17, 17, 31,	32
MPI::REAL4, 637, 638, 718	126, 674, 706, 707, 716	33
MPI::REAL8, 637, 638, 718	MPI_AINT, 31, 189, 717, 718, 870, 872	34
MPI::REPLACE, 720	MPI_ANY_SOURCE, 32, 33, 46, 57, 58,	35
MPI::REQUEST_NULL, 721	71, 72, 74–76, 83, 86, 88, 301, 354,	36
MPI::ROOT, 715	715	37
MPI::SEEK_CUR, 726	MPI_ANY_TAG, 15, 32, 33, 36, 57, 58, 71,	38
MPI::SEEK_END, 726	72, 74–77, 83, 86, 88, 89, 715	39
MPI::SEEK_SET, 726	MPI_APPNUM, 417, 418, 724	40
MPI::SHORT, 635, 636, 717	MPI_ARGV_NULL, 16, 396, 397, 673, 727	41
MPI::SHORT_INT, 637, 719	MPI_ARGVS_NULL, 16, 401, 673, 727	42
MPI::SIGNED_CHAR, 635, 636, 717	MPI_ASYNC_PROTECTS_NONBLOCKING,	43
MPI::SIMILAR, 720	16, 645, 646, 649, 652, 653, 662,	44
MPI::SUCCESS, 713	664, 686, 715, 867	45
MPI::SUM, 720	MPI_BAND, 188, 189, 720	46
MPI::TAG_UB, 720	MPI_BOR, 188, 189, 720	47
MPI::THREAD_FUNNELED, 726	MPI_BOTTOM, 10, 16, 17, 37, 110, 123,	48

- 1 155, 313, 315, 398, 432, 436, 439,
2 647, 650, 658, 673, 679, 681, 683,
3 684, 687–689, 692, 703, 704, 711,
4 715, 876
- 5 MPI_BSEND_OVERHEAD, 52, 355, 715
6 MPI_BXOR, 188, 189, 720
7 MPI_BYTE, 29, 30, 38–40, 147, 189, 514,
8 560, 573, 635, 711, 717, 718, 873
9 MPI_C_BOOL, 30, 189, 717, 861, 870, 872
10 MPI_C_COMPLEX, 30, 717, 865, 870, 872
11 MPI_C_DOUBLE_COMPLEX, 30, 189,
12 717, 870, 872
13 MPI_C_FLOAT128_COMPLEX, 865
14 MPI_C_FLOAT_COMPLEX, 30, 189, 717,
15 870, 872
16 MPI_C_LONG_DOUBLE_COMPLEX,
17 30, 31, 189, 717, 870, 872
18 MPI_C_QUAD_COMPLEX, 865
19 MPI_CART, 317, 722
20 MPI_CHAR, 30, 41, 103, 190, 191, 596,
21 717, 870
22 MPI_CHARACTER, 29, 39–41, 190, 191,
23 718
24 MPI_COMBINER_CONTIGUOUS, 125,
25 129, 725
26 MPI_COMBINER_DARRAY, 125, 130,
27 725
28 MPI_COMBINER_DUP, 125, 129, 725
29 MPI_COMBINER_F90_COMPLEX, 125,
30 131, 725
31 MPI_COMBINER_F90_INTEGER, 125,
32 131, 725
33 MPI_COMBINER_F90_REAL, 125, 131,
34 725
35 MPI_COMBINER_HINDEXED, 125, 126,
36 130, 725
37 MPI_COMBINER_HINDEXED_BLOCK,
38 130, 725, 864
39 MPI_COMBINER_HINDEXED_INTEGER,
40 125, 130, 725, 864
41 MPI_COMBINER_HVECTOR, 125, 126,
42 129, 725
43 MPI_COMBINER_HVECTOR_INTEGER,
44 125, 126, 129, 725, 864
45 MPI_COMBINER_INDEXED, 125, 129,
46 725
47 MPI_COMBINER_INDEXED_BLOCK,
48 125, 130, 725
- MPI_COMBINER_NAMED, 125, 126,
129, 725
MPI_COMBINER_RESIZED, 125, 131,
725
MPI_COMBINER_STRUCT, 125, 126,
130, 725
MPI_COMBINER_STRUCT_INTEGER,
125, 130, 725, 864
MPI_COMBINER_SUBARRAY, 125, 130,
725
MPI_COMBINER_VECTOR, 125, 129,
725
MPI_COMM_CREATE_KEYVAL, 281
MPI_COMM_NULL, 241, 254, 255, 257,
258, 260, 261, 297, 307, 309, 399,
419, 420, 721, 873
MPI_COMM_PARENT, 297
MPI_COMM_SELF, 241, 277, 297, 380,
419, 516, 719, 871
MPI_COMM_TYPE_SHARED, 261, 719,
864
MPI_COMM_WORLD, 15, 25, 32,
241–243, 250, 252, 264, 272, 273,
297, 307, 353, 354, 358, 361, 370,
378, 380, 382, 391, 392, 394, 395,
399, 401, 402, 416–419, 508, 559,
578, 579, 602, 610, 697, 710, 719,
874
MPI_COMPLEX, 29, 189, 562, 665, 718
MPI_COMPLEX16, 189, 718
MPI_COMPLEX32, 189, 718
MPI_COMPLEX4, 189, 718
MPI_COMPLEX8, 189, 718
MPI_CONGRUENT, 252, 271, 720
MPI_CONVERSION_FN_NULL, 568
MPI_COUNT, 31, 189, 596, 717, 718, 863
MPI_COUNT_KIND, 16, 31, 716
MPI_CXX_BOOL, 865
MPI_CXX_DOUBLE_COMPLEX, 865
MPI_CXX_FLOAT_COMPLEX, 865
MPI_CXX_LONG_DOUBLE_COMPLEX,
865
MPI_DATATYPE, 21
MPI_DATATYPE_NULL, 118, 721
MPI_DISPLACEMENT_CURRENT, 527,
726, 875
MPI_DIST_GRAPH, 317, 722, 871
MPI_DISTRIBUTE_BLOCK, 107, 108,

726			
MPI_DISTRIBUTE_CYCLIC, 107, 108, 726		MPI_ERR_NO_SUCH_FILE, 369, 519, 580, 714	1
MPI_DISTRIBUTE_DFLT_DARG, 107, 108, 726		MPI_ERR_NOATOMIC, 613	2
MPI_DISTRIBUTE_NONE, 107, 108, 726		MPI_ERR_NOT_SAME, 369, 580, 714	3
MPI_DOUBLE, 30, 189, 596, 606, 664, 717		MPI_ERR_OP, 368, 473, 713	4
MPI_DOUBLE_COMPLEX, 29, 189, 562, 665, 718		MPI_ERR_OTHER, 367, 368, 713	5
MPI_DOUBLE_INT, 192, 719		MPI_ERR_PENDING, 66, 368, 713	6
MPI_DOUBLE_PRECISION, 29, 189, 665, 718		MPI_ERR_PORT, 368, 410, 714	7
MPI_DUP_FN, 724		MPI_ERR_QUOTA, 369, 580, 714	8
MPI_ERR_ACCESS, 369, 519, 580, 714		MPI_ERR_RANK, 368, 473, 713	9
MPI_ERR_AMODE, 369, 517, 580, 714		MPI_ERR_READ_ONLY, 369, 580, 714	10
MPI_ERR_ARG, 368, 713		MPI_ERR_REQUEST, 368, 713	11
MPI_ERR_ASSERT, 368, 473, 714		MPI_ERR_RMA_ATTACH, 473, 714	12
MPI_ERR_BAD_FILE, 369, 580, 714		MPI_ERR_RMA_CONFLICT, 368, 473, 714	13
MPI_ERR_BASE, 357, 368, 473, 714		MPI_ERR_RMA_RANGE, 473, 714	14
MPI_ERR_BUFFER, 368, 713		MPI_ERR_RMA_SHARED, 473	15
MPI_ERR_COMM, 368, 713		MPI_ERR_RMA_SYNC, 368, 473, 714	16
MPI_ERR_CONVERSION, 369, 568, 580, 714		MPI_ERR_RMA_WRONG_FLAVOR, 431, 473	17
MPI_ERR_COUNT, 368, 713		MPI_ERR_ROOT, 368, 713	18
MPI_ERR_DIMS, 368, 713		MPI_ERR_SERVICE, 368, 412, 714	19
MPI_ERR_DISP, 368, 473, 714		MPI_ERR_SIZE, 368, 473, 714	20
MPI_ERR_DUP_DATAREP, 369, 565, 580, 714		MPI_ERR_SPAWN, 368, 397, 398, 714	21
MPI_ERR_FILE, 369, 580, 714		MPI_ERR_TAG, 368, 713	22
MPI_ERR_FILE_EXISTS, 369, 580, 714		MPI_ERR_TOPOLOGY, 368, 713	23
MPI_ERR_FILE_IN_USE, 369, 519, 580, 714		MPI_ERR_TRUNCATE, 368, 713	24
MPI_ERR_GROUP, 368, 713		MPI_ERR_TYPE, 368, 713	25
MPI_ERR_IN_STATUS, 35, 37, 58, 66, 68, 360, 368, 499, 532, 641, 714		MPI_ERR_UNKNOWN, 367, 368, 713	26
MPI_ERR_INFO, 368, 714		MPI_ERR_UNSUPPORTED_DATAREP, 369, 580, 714	27
MPI_ERR_INFO_KEY, 368, 387, 714		MPI_ERR_UNSUPPORTED_OPERATION, 369, 580, 714	28
MPI_ERR_INFO_NOKEY, 368, 387, 714		MPI_ERR_WIN, 368, 473, 714	29
MPI_ERR_INFO_VALUE, 368, 387, 714		MPI_ERRCODES_IGNORE, 16, 398, 673, 727	30
MPI_ERR_INTERN, 368, 713		MPI_ERRHANDLER_NULL, 366, 721	31
MPI_ERR_IO, 369, 580, 714		MPI_ERROR, 34, 58, 210, 450, 716	32
MPI_ERR_KEYVAL, 293, 368, 714		MPI_ERROR_STRING, 367	33
MPI_ERR_LASTCODE, 367, 369, 370, 372, 714		MPI_ERRORS_ARE_FATAL, 359, 372, 373, 473, 578, 716	34
MPI_ERR_LOCKTYPE, 368, 473, 714		MPI_ERRORS_RETURN, 359, 373, 579, 710, 716	35
MPI_ERR_NAME, 368, 413, 714		MPI_F08_STATUS_IGNORE, 701, 727, 866	36
MPI_ERR_NO_MEM, 356, 368, 714		MPI_F08_STATUSES_IGNORE, 701, 727, 866	37
MPI_ERR_NO_SPACE, 369, 580, 714		MPI_F_STATUS_IGNORE, 701, 727	38
			39
			40
			41
			42
			43
			44
			45
			46
			47
			48

- 1 MPI_F_STATUSES_IGNORE, 701, 727
2 MPI_FILE_NULL, 518, 579, 721
3 MPI_FLOAT, 30, 103, 187, 189, 561, 717
4 MPI_FLOAT128, 865
5 MPI_FLOAT_INT, 12, 192, 719
6 MPI_GRAPH, 317, 722
7 MPI_GROUP_EMPTY, 240, 246, 247,
8 254, 255, 721
9 MPI_GROUP_NULL, 240, 249, 721
10 MPI_HOST, 353, 720
11 MPI_IDENT, 244, 252, 720
12 MPI_IN_PLACE, 16, 154, 183, 650, 673,
13 715
14 MPI_INFO_GET_ENV, 865
15 MPI_INFO_KEY, 865
16 MPI_INFO_NULL, 315, 390, 398, 408,
17 517, 519, 528, 721
18 MPI_INT, 12, 30, 92, 188, 561, 562, 596,
19 597, 600, 605, 609, 664, 710, 712,
20 717
21 MPI_INT16_T, 30, 188, 717, 870, 872
22 MPI_INT32_T, 30, 188, 717, 870, 872
23 MPI_INT64_T, 30, 188, 717, 870, 872
24 MPI_INT8_T, 30, 188, 717, 870, 872
25 MPI_INTEGER, 29, 38, 189, 664, 665,
26 712, 718
27 MPI_INTEGER1, 29, 189, 718
28 MPI_INTEGER16, 189, 718
29 MPI_INTEGER2, 29, 189, 562, 718
30 MPI_INTEGER4, 29, 189, 718
31 MPI_INTEGER8, 189, 669, 718
32 MPI_INTEGER_KIND, 16, 126, 706, 716
33 MPI_IO, 353, 354, 720
34 MPI_KEYVAL_INVALID, 282–284, 715
35 MPI_LAND, 188, 189, 720
36 MPI_LASTUSED_CODE, 370, 371, 724
37 MPI_LB, 18, 19, 105, 109, 113, 115–117,
38 119, 120, 561, 719, 864
39 MPI_LOCK_EXCLUSIVE, 466, 715
40 MPI_LOCK_SHARED, 466, 715
41 MPI_LOGICAL, 29, 189, 718
42 MPI_LONG, 30, 188, 717
43 MPI_LONG_DOUBLE, 30, 189, 717
44 MPI_LONG_DOUBLE_INT, 192, 719
45 MPI_LONG_INT, 192, 719
46 MPI_LONG_LONG, 30, 188, 717, 872
47 MPI_LONG_LONG_INT, 30, 188, 717,
48 872
- MPI_LOR, 188, 189, 720
MPI_LXOR, 188, 189, 720
MPI_MAX, 187–189, 208, 720
MPI_MAX_DATAREP_STRING, 16, 529,
565, 716
MPI_MAX_ERROR_STRING, 16, 367,
372, 716
MPI_MAX_INFO_KEY, 16, 368, 385, 388,
716
MPI_MAX_INFO_VAL, 16, 368, 385, 716
MPI_MAX_LIBRARY_VERSION_STRING,
16, 352, 353, 716, 862
MPI_MAX_OBJECT_NAME, 16,
296–298, 716, 862, 873
MPI_MAX_PORT_NAME, 16, 407, 716
MPI_MAX_PROCESSOR_NAME, 15,
355, 716, 874
MPI_MAXLOC, 188, 191, 192, 195, 720
MPI_MESSAGE_NO_PROC, 862
MPI_MESSAGE_NULL, 77, 78, 721, 862
MPI_MIN, 188, 189, 720
MPI_MINLOC, 188, 191, 192, 195, 720
MPI_MODE_APPEND, 516, 517, 725
MPI_MODE_CREATE, 516, 517, 525, 725
MPI_MODE_DELETE_ON_CLOSE,
516–518, 725
MPI_MODE_EXCL, 516, 517, 725
MPI_MODE_NOCHECK, 467, 471, 472,
725
MPI_MODE_NOPRECEDE, 471, 472, 725
MPI_MODE_NOPUT, 471, 472, 725
MPI_MODE_NOSTORE, 471, 472, 725
MPI_MODE_NOSUCCESS, 471, 472, 725
MPI_MODE_RDONLY, 516, 517, 522, 725
MPI_MODE_RDWR, 516, 517, 725
MPI_MODE_SEQUENTIAL, 516, 517,
519, 520, 527, 532, 537, 549, 572,
725, 875
MPI_MODE_UNIQUE_OPEN, 516, 517,
725
MPI_MODE_WRONLY, 516, 517, 725
MPI_NO_OP, 447–449, 720
MPI_NULL_COPY_FN, 724
MPI_NULL_DELETE_FN, 724
MPI_OFFSET, 31, 189, 717, 718, 870, 872
MPI_OFFSET_KIND, 16, 17, 31, 573,
674, 716
MPI_OP_NULL, 198, 721

MPI_ORDER_C, 15, 104, 105, 107, 108, 726	MPI_T_BIND_MPI_COMM, 594, 728	1
MPI_ORDER_FORTRAN, 15, 104, 105, 107, 108, 726	MPI_T_BIND_MPI_DATATYPE, 594, 728	2
MPI_PACKED, 29, 30, 38, 141, 143, 147, 563, 635, 711, 717, 718	MPI_T_BIND_MPI_ERRHANDLER, 594, 728	3
MPI_PROC_NULL, 28, 76, 77, 89, 157, 159, 161, 163, 171, 173, 188, 243, 326, 330, 353, 354, 431, 438, 715, 862, 873, 875	MPI_T_BIND_MPI_FILE, 594, 728	4
MPI_PROD, 188, 189, 720	MPI_T_BIND_MPI_GROUP, 594, 728	5
MPI_QUAD, 865	MPI_T_BIND_MPI_INFO, 594, 728	6
MPI_REAL, 29, 38, 189, 562, 664, 665, 672, 718	MPI_T_BIND_MPI_MESSAGE, 594, 728	7
MPI_REAL16, 189, 718	MPI_T_BIND_MPI_OP, 594, 728	8
MPI_REAL2, 29, 189, 718	MPI_T_BIND_MPI_REQUEST, 594, 728	9
MPI_REAL4, 29, 189, 664, 669, 718	MPI_T_BIND_MPI_WIN, 594, 728	10
MPI_REAL8, 29, 189, 664, 718, 870	MPI_T_BIND_NO_OBJECT, 594, 600, 602, 609, 610, 728	11
MPI_REPLACE, 445–449, 490, 720, 871, 872, 875	MPI_T_CVAR_HANDLE_NULL, 602, 727	12
MPI_REQUEST_NULL, 58–61, 63–65, 67, 68, 498, 721	MPI_T_ENUM_NULL, 600, 609, 727	13
MPI_ROOT, 157, 715	MPI_T_ERR_CANTINIT, 620, 715	14
MPI_SEEK_CUR, 543, 550, 726	MPI_T_ERR_CVAR_SETNEVER, 603, 620, 715	15
MPI_SEEK_END, 543, 550, 726	MPI_T_ERR_CVAR_SETNOTNOW, 603, 620, 715	16
MPI_SEEK_SET, 543, 550, 726	MPI_T_ERR_INVALIDHANDLE, 620, 715	17
MPI_SHORT, 30, 188, 717	MPI_T_ERR_INVALIDINDEX, 620, 715	18
MPI_SHORT_INT, 192, 719	MPI_T_ERR_INVALIDITEM, 620, 715	19
MPI_SIGNED_CHAR, 30, 188, 190, 191, 717, 872	MPI_T_ERR_INVALIDSESSION, 620, 715	20
MPI_SIMILAR, 244, 252, 271, 720	MPI_T_ERR_MEMORY, 620, 715	21
MPI_SOURCE, 34, 210, 450, 716	MPI_T_ERR_NOTINITIALIZED, 620, 715	22
MPI_STATUS, 22, 36, 37, 58, 863	MPI_T_ERR_OUTOFHANDLES, 620, 715	23
MPI_STATUS_IGNORE, 10, 16, 36, 37, 497, 532, 650, 673, 700, 701, 711, 727, 860, 866	MPI_T_ERR_OUTOFSESSIONS, 620, 715	24
MPI_STATUS_SIZE, 16, 34, 652, 716	MPI_T_ERR_PVAR_NOATOMIC, 715	25
MPI_STATUSES_IGNORE, 15, 16, 36, 37, 497, 499, 673, 700, 701, 727, 860	MPI_T_ERR_PVAR_NOSTARTSTOP, 611, 612, 620, 715	26
MPI_SUBARRAYS_SUPPORTED, 16, 645–647, 650, 652–656, 659–662, 675–677, 715, 866	MPI_T_ERR_PVAR_NOWRITE, 612, 613, 620, 715	27
MPI_SUBVERSION, 352, 727	MPI_T_NOATOMIC, 620	28
MPI_SUCCESS, 19, 20, 58, 66, 68, 281–283, 285–287, 290, 291, 367, 368, 372, 373, 398, 568, 592, 611–613, 620, 625, 713	MPI_T_PVAR_ALL_HANDLES, 611–614, 728	29
MPI_SUM, 188, 189, 710, 720	MPI_T_PVAR_CLASS_AGGREGATE, 606, 729	30
	MPI_T_PVAR_CLASS_COUNTER, 606, 729	31
	MPI_T_PVAR_CLASS_GENERIC, 606, 729	32

1	MPI_T_PVAR_CLASS_HIGHWATERMARK,	MPI_TYPECLASS_REAL, 670, 726
2	605, 729	MPI_UB, 12, 18, 19, 105, 109, 113, 115,
3	MPI_T_PVAR_CLASS_LEVEL, 605, 729	116, 119, 120, 561, 719, 864
4	MPI_T_PVAR_CLASS_LOWWATERMARK,	MPI_UINT16_T, 30, 188, 717, 870, 872
5	606, 729	MPI_UINT32_T, 30, 189, 717, 870, 872
6	MPI_T_PVAR_CLASS_PERCENTAGE,	MPI_UINT64_T, 30, 189, 717, 870, 872
7	605, 729	MPI_UINT8_T, 30, 188, 717, 870, 872
8	MPI_T_PVAR_CLASS_SIZE, 605, 729	MPI_UNDEFINED, 35, 36, 63–65, 68, 69,
9	MPI_T_PVAR_CLASS_STATE, 605, 729	112, 115, 117, 121, 122, 144, 242,
10	MPI_T_PVAR_CLASS_TIMER, 606, 729	243, 258, 317, 328, 329, 666, 667,
11	MPI_T_PVAR_HANDLE_NULL, 611, 727	715, 863, 872
12	MPI_T_PVAR_SESSION_NULL, 610, 727	MPI_UNEQUAL, 244, 252, 271, 720
13	MPI_T_SCOPE_ALL, 600	MPI_UNIVERSE_SIZE, 394, 416, 724
14	MPI_T_SCOPE_ALL_EQ, 600	MPI_UNSIGNED, 30, 188, 596, 717
15	MPI_T_SCOPE_GLOBAL, 728	MPI_UNSIGNED_CHAR, 30, 188, 190,
16	MPI_T_SCOPE_GLOBAL_EQ, 603, 728	191, 717
17	MPI_T_SCOPE_GROUP, 600, 728	MPI_UNSIGNED_LONG, 30, 188, 596,
18	MPI_T_SCOPE_GROUP_EQ, 600, 603,	717
19	728	MPI_UNSIGNED_LONG_LONG, 30, 188,
20	MPI_T_SCOPE_LOCAL, 600, 728	596, 717, 872
21	MPI_T_SCOPE_READONLY, 600, 728	MPI_UNSIGNED_SHORT, 30, 188, 717
22	MPI_T_VERBOSITY_MPIDEV_ALL,	MPI_UNWEIGHTED, 16, 312, 314, 315,
23	593, 728	323, 325, 673, 727, 864, 871
24	MPI_T_VERBOSITY_MPIDEV_BASIC,	MPI_VAL, 13, 697
25	593, 728	MPI_VERSION, 352, 727
26	MPI_T_VERBOSITY_MPIDEV_DETAIL,	MPI_WCHAR, 30, 190, 191, 298, 562, 717,
27	593, 728	872
28	MPI_T_VERBOSITY_TUNER_ALL, 593,	MPI_WEIGHTS_EMPTY, 864
29	728	MPI_WIN_BASE, 435, 436, 710, 724
30	MPI_T_VERBOSITY_TUNER_BASIC,	MPI_WIN_CREATE_FLAVOR, 436, 724
31	593, 728	MPI_WIN_DISP_UNIT, 435, 436, 724
32	MPI_T_VERBOSITY_TUNER_DETAIL,	MPI_WIN_FLAVOR_ALLOCATE, 436,
33	593, 728	724
34	MPI_T_VERBOSITY_USER_ALL, 593,	MPI_WIN_FLAVOR_CREATE, 436, 724
35	728	MPI_WIN_FLAVOR_DYNAMIC, 436,
36	MPI_T_VERBOSITY_USER_BASIC,	724
37	593, 728	MPI_WIN_FLAVOR_SHARED, 436, 724
38	MPI_T_VERBOSITY_USER_DETAIL,	MPI_WIN_MODEL, 436, 456, 724
39	593, 728	MPI_WIN_NULL, 435, 721
40	MPI_TAG, 34, 210, 450, 716	MPI_WIN_SEPARATE, 436, 456, 475, 724
41	MPI_TAG_UB, 31, 353, 706, 710, 720	MPI_WIN_SIZE, 435, 436, 724
42	MPI_THREAD_FUNNELED, 508, 726	MPI_WIN_UNIFIED, 436, 456, 476, 485,
43	MPI_THREAD_MULTIPLE, 508, 509,	724
44	511, 726	MPI_WTIME_IS_GLOBAL, 353, 354,
45	MPI_THREAD_SERIALIZED, 508, 726	374, 706, 720
46	MPI_THREAD_SINGLE, 508, 509, 726	
47	MPI_TYPECLASS_COMPLEX, 670, 726	
48	MPI_TYPECLASS_INTEGER, 670, 726	

1
2
3
4
5
6
7
8
9
10
11
12
13
14
15
16
17
18
19
20
21
22
23
24
25
26
27
28
29
30
31
32
33
34
35
36
37
38
39
40
41
42
43
44
45
46
47
48

MPI Declarations Index

This index refers to declarations needed in C/C++, such as address kind integers, handles, etc. The underlined page numbers is the “main” reference (sometimes there are more than one when key concepts are discussed in multiple areas).

- MPI::Aint, [17](#), [17](#), [21](#), [93](#), [93](#), [96](#), [99](#), [102](#),
[111](#), [115](#), [116](#), [126](#), [148](#), [149](#), [425](#),
[427](#), [429](#), [432](#), [438](#), [440](#), [444](#), [446](#),
[448–452](#), [454](#), [561](#), [565](#), [621–624](#),
[705](#), [705](#), [706](#), [729](#)
- MPI::Cartcomm, [307](#), [632](#), [638](#), [730](#)
- MPI::Comm, [28](#), [244](#), [250–252](#), [254](#), [257](#),
[260](#), [261](#), [270](#), [271](#), [273](#), [274](#), [280](#),
[283–285](#), [632](#), [638](#), [639](#), [730](#)
- MPI::Datatype, [21](#), [93](#), [632](#), [730](#)
- MPI::Distgraphcomm, [638](#), [730](#), [871](#)
- MPI::Errhandler, [360](#), [361–366](#), [627](#), [628](#),
[632](#), [698](#), [730](#)
- MPI::Exception, [21](#), [24](#), [632](#), [640](#), [730](#)
- MPI::File, [364](#), [365](#), [373](#), [515](#), [518–524](#),
[526](#), [528](#), [532–540](#), [542](#), [543](#),
[545–550](#), [552–558](#), [561](#), [570](#), [571](#),
[632](#), [698](#), [730](#)
- MPI::Graphcomm, [309](#), [632](#), [638](#), [730](#)
- MPI::Grequest, [496](#), [496](#), [632](#), [730](#)
- MPI::Group, [242](#), [242](#), [243–249](#), [254](#), [271](#),
[436](#), [461](#), [463](#), [521](#), [632](#), [698](#), [730](#)
- MPI::Info, [355](#), [385](#), [385](#), [386–390](#), [394](#),
[397](#), [400](#), [407–410](#), [412](#), [515](#), [518](#),
[523](#), [524](#), [526](#), [632](#), [698](#), [730](#)
- MPI::Intercomm, [632](#), [638](#), [730](#)
- MPI::Intracomm, [632](#), [638](#), [730](#)
- MPI::Message, [698](#)
- MPI::Offset, [17](#), [17](#), [21](#), [519–521](#), [526](#), [528](#),
[532–536](#), [542](#), [543](#), [549](#), [550](#), [552](#),
[553](#), [566](#), [573](#), [729](#)
- MPI::Op, [186](#), [195](#), [198](#), [200–204](#), [206](#), [207](#),
[223–228](#), [444](#), [446](#), [448](#), [452](#), [454](#),
[632](#), [698](#), [730](#)
- MPI::Prequest, [81](#), [632](#), [730](#)
- MPI::Request, [54–57](#), [58](#), [59](#), [60](#), [63–68](#), [70](#),
[78](#), [81–85](#), [496](#), [499](#), [535](#), [536](#), [540](#),
[542](#), [546](#), [547](#), [632](#), [698](#), [730](#)
- MPI::Status, [32](#), [35](#), [58](#), [59](#), [63–68](#), [70–72](#),
[75](#), [76](#), [77](#), [79](#), [86](#), [88](#), [121](#), [497](#),
[503](#), [504](#), [532–534](#), [537–540](#), [545](#),
[548](#), [553–558](#), [632](#), [633](#), [700](#), [701](#),
[729](#)
- MPI::Win, [286](#), [288](#), [289](#), [299](#), [363](#), [364](#),
[372](#), [425](#), [427](#), [429](#), [432](#), [434](#), [436](#),
[438](#), [440](#), [444](#), [446](#), [448–452](#), [454](#),
[460–464](#), [466](#), [467](#), [469](#), [470](#), [632](#),
[698](#), [730](#)
- MPI_Aint, [17](#), [17](#), [20](#), [31](#), [93](#), [93](#), [96](#), [99](#),
[102](#), [111](#), [115](#), [116](#), [126](#), [148](#), [149](#),
[425](#), [427](#), [429](#), [432](#), [438](#), [440](#), [444](#),
[446](#), [448–452](#), [454](#), [561](#), [565](#),
[621–624](#), [674](#), [705](#), [705](#), [706](#), [707](#),
[729](#)
- MPI_Comm, [13](#), [28](#), [244](#), [250–252](#), [254](#),
[257](#), [260](#), [261](#), [270](#), [271](#), [273](#), [274](#),
[280](#), [283–285](#), [719](#), [721](#), [729](#), [730](#)
- MPI_Count, [17](#), [31](#), [729](#), [863](#)
- MPI_Datatype, [93](#), [683](#), [717–719](#), [721](#), [729](#),
[730](#)
- MPI_Errhandler, [360](#), [361–366](#), [627](#), [628](#),
[698](#), [716](#), [721](#), [729](#), [730](#)
- MPI_F08_status, [701](#), [727](#), [729](#), [866](#)
- MPI_File, [364](#), [365](#), [373](#), [515](#), [518–524](#),
[526](#), [528](#), [532–540](#), [542](#), [543](#),
[545–550](#), [552–558](#), [561](#), [570](#), [571](#),
[698](#), [721](#), [729](#), [730](#)
- MPI_Fint, [697](#), [727](#), [729](#), [872](#)
- MPI_Group, [242](#), [242](#), [243–249](#), [254](#), [271](#),
[436](#), [461](#), [463](#), [521](#), [698](#), [721](#), [729](#),

1 730
2 MPI_Info, 355, 385, [385](#), 386–390, 394,
3 397, 400, 407–410, 412, 515, 518,
4 523, 524, 526, 698, 721, 729, 730,
5 875
6 MPI_Message, 698, 721, 729, 862
7 MPI_Offset, 17, [17](#), 20, 31, 519–521, 526,
8 528, 532–536, 542, 543, 549, 550,
9 552, 553, 566, 573, [573](#), 696, 729
10 MPI_Op, 186, [195](#), 198, 200–204, 206, 207,
11 223–228, 444, 446, 448, 452, 454,
12 698, 720, 721, 729, 730
13 MPI_Request, 54–57, [58](#), 59, 60, 63–68, 70,
14 78, 81–85, 496, 499, 535, 536, 540,
15 542, 546, 547, 698, 721, 729, 730
16 MPI_Status, [32](#), 34, 35, 37, 58, 59, 63–68,
17 70–72, 75, 76, [77](#), 79, 86, 88, 121,
18 497, 503, 504, 532–534, 537–540,
19 545, 548, 553–558, 649, 700–703,
20 727, 729, 730, 866
21 MPI_T_cvar_handle, 601
22 MPI_T_enum, 597
23 MPI_T_pvar_handle, 610
24 MPI_T_pvar_session, 609
25 MPI_Win, 286, 288, 289, 299, 363, 364,
26 372, [425](#), [427](#), [429](#), [432](#), 434, 436,
27 438, 440, 444, 446, 448–452, 454,
28 460–464, 466, 467, 469, 470, 698,
29 721, 729, 730
30
31
32
33
34
35
36
37
38
39
40
41
42
43
44
45
46
47
48

MPI Callback Function Prototype Index

This index lists the C typedef names for callback routines, such as those used with attribute caching or user-defined reduction operations. C++ names for these typedefs and Fortran example prototypes are given near the text of the C name.

- MPI_Comm_copy_attr_function, [19](#), [280](#),
[647](#), [723](#), [731](#)
- MPI_Comm_delete_attr_function, [19](#), [280](#),
[723](#), [731](#)
- MPI_Comm_errhandler_fn, [628](#), [871](#)
- MPI_Comm_errhandler_function, [19](#), [360](#),
[628](#), [731](#), [871](#)
- MPI_Copy_function, [19](#), [624](#), [724](#), [737](#)
- MPI_Datarep_conversion_function, [566](#),
[731](#)
- MPI_Datarep_extent_function, [565](#), [731](#)
- MPI_Delete_function, [19](#), [625](#), [724](#), [737](#)
- MPI_File_errhandler_fn, [628](#), [871](#)
- MPI_File_errhandler_function, [364](#), [628](#),
[731](#), [871](#)
- MPI_Grequest_cancel_function, [498](#), [731](#)
- MPI_Grequest_free_function, [497](#), [731](#)
- MPI_Grequest_query_function, [497](#), [731](#)
- MPI_Handler_function, [19](#), [627](#), [737](#), [864](#)
- MPI_Type_copy_attr_function, [290](#), [723](#),
[731](#)
- MPI_Type_delete_attr_function, [290](#), [723](#),
[731](#), [866](#)
- MPI_User_function, [195](#), [199](#), [730](#)
- MPI_Win_copy_attr_function, [286](#), [723](#),
[731](#)
- MPI_Win_delete_attr_function, [286](#), [723](#),
[731](#)
- MPI_Win_errhandler_fn, [628](#), [871](#)
- MPI_Win_errhandler_function, [363](#), [628](#),
[731](#), [871](#)

MPI Function Index

The underlined page numbers refer to the function definitions.

- MPI_ABORT, [196](#), [359](#), [376](#), [379](#), [418](#),
[596](#), [697](#), [875](#)
- MPI_ACCUMULATE, [423](#), [424](#), [437](#), [438](#),
[444](#), [445](#), [447](#), [453](#), [457](#), [482](#), [489](#),
[490](#), [871](#), [872](#), [875](#)
- MPI_ADD_ERROR_CLASS, [370](#), [370](#)
- MPI_ADD_ERROR_CODE, [371](#)
- MPI_ADD_ERROR_STRING, [371](#), [372](#)
- MPI_ADDRESS, [19](#), [111](#), [623](#), [656](#), [658](#),
[705](#), [706](#), [864](#)
- MPI_ALLGATHER, [151](#), [155](#), [156](#), [176](#),
[177](#), [179](#), [180](#), [218](#)
- MPI_ALLGATHERV, [151](#), [155](#), [156](#), [178](#),
[178](#), [179](#), [219](#)
- MPI_ALLOC_MEM, [355](#), [356](#), [357](#), [368](#),
[427–431](#), [433](#), [439](#), [468](#), [655](#), [656](#),
[658–661](#), [673](#), [867](#)
- MPI_ALLOC_MEM_CPTR, [356](#), [655](#)
- MPI_ALLREDUCE, [151](#), [154–156](#), [188](#),
[195](#), [200](#), [200](#), [225](#), [873](#)
- MPI_ALLTOALL, [151](#), [155](#), [156](#), [180](#), [180](#),
[181](#), [183](#), [220](#), [870](#)
- MPI_ALLTOALLV, [151](#), [155](#), [156](#), [182](#),
[183](#), [185](#), [221](#), [870](#)
- MPI_ALLTOALLW, [151](#), [155](#), [156](#), [184](#),
[185](#), [223](#), [870](#)
- MPI_ATTR_DELETE, [19](#), [285](#), [293](#), [625](#),
[626](#)
- MPI_ATTR_GET, [19](#), [284](#), [293](#), [626](#), [706](#),
[707](#)
- MPI_ATTR_PUT, [19](#), [284](#), [293](#), [626](#), [706](#),
[707](#), [710](#)
- MPI_BARRIER, [151](#), [155](#), [156](#), [157](#), [158](#),
[212](#), [479](#), [480](#), [575](#)
- MPI_BCAST, [151](#), [155](#), [156](#), [158](#), [158](#), [159](#),
[187](#), [212](#), [633](#)
- MPI_Bcast, [232](#)
- MPI_BSEND, [43](#), [52](#), [355](#), [377](#)
- MPI_BSEND_INIT, [81](#), [85](#)
- MPI_BUFFER_ATTACH, [23](#), [49](#), [59](#)
- MPI_BUFFER_DETACH, [50](#), [377](#), [866](#)
- MPI_CANCEL, [46](#), [59](#), [71](#), [78](#), [78](#), [79](#), [80](#),
[210](#), [450](#), [495](#), [499](#), [500](#)
- MPI_CART_COORDS, [305](#), [306](#), [320](#), [320](#),
[874](#)
- MPI_CART_CREATE, [269](#), [304–306](#), [306](#),
[307–309](#), [319](#), [327](#), [328](#), [330](#), [675](#),
[873](#)
- MPI_CART_GET, [305](#), [306](#), [319](#), [319](#), [874](#)
- MPI_CART_MAP, [306](#), [328](#), [328](#), [862](#)
- MPI_CART_RANK, [305](#), [306](#), [319](#), [320](#),
[874](#)
- MPI_CART_SHIFT, [305](#), [306](#), [325](#), [326](#),
[326](#), [330](#), [874](#)
- MPI_CART_SUB, [305](#), [306](#), [327](#), [327](#), [328](#),
[329](#), [874](#)
- MPI_CARTDIM_GET, [305](#), [306](#), [318](#), [319](#),
[874](#)
- MPI_CLOSE_PORT, [407](#), [408](#), [411](#)
- MPI_COMM_ACCEPT, [406](#), [407](#), [408](#),
[409](#), [410](#), [416](#), [418](#)
- MPI_COMM_C2F, [697](#)
- MPI_COMM_CALL_ERRHANDLER,
[372](#), [373](#)
- MPI_COMM_CLONE, [639](#)
- MPI_COMM_COMPARE, [251](#), [271](#)
- MPI_COMM_CONNECT, [368](#), [409](#), [410](#),
[416](#), [418](#)
- MPI_COMM_CREATE, [249](#), [254](#), [254](#),
[255–258](#), [305](#), [871](#)
- MPI_COMM_CREATE_ERRHANDLER,
[19](#), [359](#), [360](#), [360](#), [362](#), [627](#), [735](#),
[866](#)
- MPI_Comm_create_errhandler, [733](#)

MPI_COMM_CREATE_GROUP, 864	MPI_COMM_SIZE, 22 , 250 , 251 , 271	1
MPI_COMM_CREATE_KEYVAL, 19 , 278 , 279 , 282 , 293 , 624 , 705 , 706 , 734 , 865 , 873	MPI_COMM_SPAWN, 382 , 392–394 , 394 , 395 , 397–399 , 401–403 , 416 , 417	2
MPI_Comm_create_keyval, 731	MPI_COMM_SPAWN_MULTIPLE, 382 , 392 , 393 , 399 , 400 , 401 , 402 , 417	3
MPI_COMM_DELETE_ATTR, 19 , 278 , 281 , 283 , 285 , 293 , 626	MPI_COMM_SPLIT, 254 , 255 , 257 , 257 , 258 , 259 , 300 , 305–307 , 309 , 327–329 , 871	4
MPI_COMM_DISCONNECT, 293 , 399 , 418 , 418 , 419	MPI_COMM_SPLIT_TYPE, 260 , 864	5
MPI_COMM_DUP, 244 , 249 , 252 , 253 , 255 , 261 , 272 , 274 , 278 , 281 , 285 , 293 , 300 , 624 , 864	MPI_COMM_TEST_INTER, 269 , 270	6
MPI_COMM_DUP_FN, 19 , 281 , 281 , 282 , 656 , 723 , 865	MPI_COMPARE_AND_SWAP, 424 , 437 , 449 , 488	7
MPI_COMM_DUP_INFO, 864	MPI_Count, 863	8
MPI_COMM_F2C, 697	MPI_DIMS_CREATE, 305 , 307 , 307 , 308	9
MPI_COMM_FREE, 250 , 253 , 261 , 261 , 272 , 274 , 281–283 , 285 , 293 , 380 , 399 , 418 , 419 , 625 , 635	MPI_DIST_GRAPH_CREATE, 304 , 305 , 310 , 313 , 314–316 , 325 , 330 , 871	10
MPI_COMM_FREE_KEYVAL, 19 , 278 , 282 , 293 , 625	MPI_Dist_graph_create, 314	11
MPI_COMM_GET_ATTR, 19 , 278 , 283 , 284 , 293 , 353 , 626 , 707 , 710	MPI_DIST_GRAPH_CREATE_ADJACENT, 304 , 305 , 310 , 311 , 312 , 316 , 325 , 330 , 863 , 871	12
MPI_COMM_GET_ERRHANDLER, 19 , 359 , 362 , 628 , 874	MPI_DIST_GRAPH_NEIGHBOR_COUNT, 325	13
MPI_COMM_GET_INFO, 864	MPI_DIST_GRAPH_NEIGHBORS, 306 , 323 , 324 , 325 , 330 , 863 , 871	14
MPI_COMM_GET_NAME, 296 , 296 , 297 , 873	MPI_DIST_GRAPH_NEIGHBORS_COUNT, 306 , 323 , 323 , 325 , 861 , 871	15
MPI_COMM_GET_PARENT, 297 , 395 , 398 , 399	MPI_DIST_NEIGHBORS, 305	16
MPI_COMM_GROUP, 14 , 242 , 244 , 244 , 249–251 , 271 , 360 , 874	MPI_DIST_NEIGHBORS_COUNT, 305	17
MPI_COMM_IDUP, 862	MPI_DUP_FN, 19 , 281 , 625	18
MPI_COMM_JOIN, 419 , 420 , 421	MPI_ERRHANDLER_C2F, 698	19
MPI_COMM_KEYVAL_CREATE, 656	MPI_ERRHANDLER_CREATE, 19 , 360 , 627 , 864 , 867	20
MPI_COMM_NULL_COPY_FN, 19 , 281 , 281 , 282 , 705 , 723 , 865	MPI_ERRHANDLER_F2C, 698	21
MPI_COMM_NULL_DELETE_FN, 19 , 282 , 282 , 723	MPI_ERRHANDLER_FREE, 359 , 366 , 874	22
MPI_COMM_RANK, 250 , 251 , 271 , 656	MPI_ERRHANDLER_GET, 19 , 360 , 362 , 628 , 864 , 874	23
MPI_COMM_REMOTE_GROUP, 271	MPI_ERRHANDLER_SET, 19 , 362 , 627 , 864	24
MPI_COMM_REMOTE_SIZE, 271 , 272	MPI_ERROR_CLASS, 367 , 367 , 369	25
MPI_COMM_SET_ATTR, 19 , 278 , 281 , 283 , 293 , 625 , 707 , 710	MPI_ERROR_STRING, 366 , 367 , 369 , 372	26
MPI_COMM_SET_ERRHANDLER, 19 , 359 , 361 , 627	MPI_EXSCAN, 152 , 155 , 188 , 207 , 207 , 228 , 871	27
MPI_COMM_SET_INFO, 864	MPI_F_SYNC_REG, 111 , 645 , 662 , 663 , 664 , 685–689 , 691 , 867	28
MPI_COMM_SET_NAME, 295 , 295 , 296	MPI_FETCH_AND_OP, 424 , 437 , 445 , 447 , 448	29
	MPI_FILE_C2F, 698	30

- 1 MPI_FILE_CALL_ERRHANDLER, [373](#),
2 [373](#)
- 3 MPI_FILE_CLOSE, [419](#), [515](#), [516](#), [518](#),
4 [518](#)
- 5 MPI_FILE_CREATE_ERRHANDLER,
6 [359](#), [360](#), [364](#), [365](#), [735](#), [867](#)
- 7 MPI_File_create_errhandler, [733](#)
- 8 MPI_FILE_DELETE, [517](#), [518](#), [518](#), [519](#),
9 [523](#), [525](#), [579](#)
- 10 MPI_FILE_F2C, [698](#)
- 11 MPI_FILE_GET_AMODE, [522](#), [522](#)
- 12 MPI_FILE_GET_ATOMICITY, [571](#), [571](#)
- 13 MPI_FILE_GET_BYTE_OFFSET, [537](#),
14 [543](#), [543](#), [544](#), [550](#)
- 15 MPI_FILE_GET_ERRHANDLER, [359](#),
16 [365](#), [579](#), [874](#)
- 17 MPI_FILE_GET_GROUP, [521](#), [521](#)
- 18 MPI_FILE_GET_INFO, [524](#), [524](#), [525](#), [875](#)
- 19 MPI_FILE_GET_POSITION, [543](#), [543](#)
- 20 MPI_FILE_GET_POSITION_SHARED,
21 [549](#), [550](#), [550](#), [572](#)
- 22 MPI_FILE_GET_SIZE, [521](#), [521](#), [574](#)
- 23 MPI_FILE_GET_TYPE_EXTENT, [560](#),
24 [561](#), [561](#), [568](#)
- 25 MPI_FILE_GET_VIEW, [528](#), [529](#)
- 26 MPI_FILE_IREAD, [529](#), [540](#), [541](#), [551](#),
27 [569](#)
- 28 MPI_FILE_IREAD_AT, [529](#), [535](#), [536](#)
- 29 MPI_FILE_IREAD_SHARED, [529](#), [546](#),
30 [546](#)
- 31 MPI_FILE_IWRITE, [529](#), [542](#), [542](#)
- 32 MPI_FILE_IWRITE_AT, [529](#), [536](#), [536](#)
- 33 MPI_FILE_IWRITE_SHARED, [529](#), [547](#),
34 [547](#)
- 35 MPI_FILE_OPEN, [369](#), [507](#), [515](#), [515](#),
36 [516](#), [517](#), [523](#)–[525](#), [527](#), [544](#), [573](#),
37 [574](#), [579](#), [580](#)
- 38 MPI_FILE_PREALLOCATE, [519](#), [520](#),
39 [520](#), [569](#), [574](#)
- 40 MPI_FILE_READ, [529](#), [530](#), [537](#), [537](#),
41 [539](#), [541](#), [573](#), [574](#)
- 42 MPI_FILE_READ_ALL, [529](#), [538](#), [539](#),
43 [551](#), [552](#)
- 44 MPI_FILE_READ_ALL_BEGIN, [529](#),
45 [551](#), [552](#), [554](#), [569](#), [691](#)
- 46 MPI_FILE_READ_ALL_END, [529](#), [551](#),
47 [552](#), [555](#), [569](#), [691](#)
- 48 MPI_FILE_READ_AT, [529](#), [532](#), [533](#), [536](#)
- MPI_FILE_READ_AT_ALL, [529](#), [533](#),
[533](#)
- MPI_FILE_READ_AT_ALL_BEGIN, [529](#),
[552](#), [691](#)
- MPI_FILE_READ_AT_ALL_END, [529](#),
[553](#), [691](#)
- MPI_FILE_READ_ORDERED, [529](#), [548](#),
[548](#)
- MPI_FILE_READ_ORDERED_BEGIN,
[529](#), [556](#), [691](#)
- MPI_FILE_READ_ORDERED_END,
[529](#), [557](#), [691](#)
- MPI_FILE_READ_SHARED, [529](#), [545](#),
[545](#), [546](#), [548](#)
- MPI_FILE_SEEK, [542](#), [543](#)
- MPI_FILE_SEEK_SHARED, [549](#), [549](#),
[550](#), [572](#)
- MPI_FILE_SET_ATOMICITY, [517](#), [570](#),
[570](#), [571](#)
- MPI_FILE_SET_ERRHANDLER, [359](#),
[365](#), [579](#)
- MPI_FILE_SET_INFO, [523](#), [523](#), [524](#),
[525](#), [875](#)
- MPI_FILE_SET_SIZE, [519](#), [519](#), [520](#), [569](#),
[572](#), [574](#)
- MPI_FILE_SET_VIEW, [106](#), [369](#), [516](#),
[523](#)–[526](#), [526](#), [527](#), [528](#), [543](#), [550](#),
[559](#), [565](#), [573](#), [580](#), [875](#)
- MPI_FILE_SYNC, [518](#), [530](#), [569](#), [570](#), [571](#),
[572](#), [576](#)
- MPI_FILE_WRITE, [529](#), [530](#), [539](#), [539](#),
[540](#), [542](#), [573](#)
- MPI_FILE_WRITE_ALL, [529](#), [540](#), [540](#)
- MPI_FILE_WRITE_ALL_BEGIN, [529](#),
[555](#), [676](#), [691](#)
- MPI_FILE_WRITE_ALL_END, [529](#), [556](#),
[691](#)
- MPI_FILE_WRITE_AT, [529](#), [530](#), [534](#),
[534](#), [535](#), [536](#)
- MPI_FILE_WRITE_AT_ALL, [529](#), [534](#),
[535](#)
- MPI_FILE_WRITE_AT_ALL_BEGIN,
[529](#), [553](#), [653](#), [691](#)
- MPI_FILE_WRITE_AT_ALL_END, [529](#),
[554](#), [691](#)
- MPI_FILE_WRITE_ORDERED, [529](#),
[547](#), [548](#), [549](#)
- MPI_FILE_WRITE_ORDERED_BEGIN,

529, 557 , 691	MPI_GREQUEST_START, 496 , 497 , 735 , 872	1
MPI_FILE_WRITE_ORDERED_END, 529 , 558 , 691	MPI_Grequest_start, 733	2
MPI_FILE_WRITE_SHARED, 529 , 530 , 545 , 546 , 547 , 549	MPI_GROUP_C2F, 698	3
MPI_FINALIZE, 15 , 25 , 352 , 353 , 376 , 376 , 377–381 , 418 , 419 , 506 , 516 , 592 , 601 , 614 , 616 , 697 , 701 , 863 , 865 , 874	MPI_GROUP_COMPARE, 243 , 247	4
MPI_FINALIZED, 21 , 375 , 378 , 380 , 381 , 381 , 697	MPI_GROUP_DIFFERENCE, 245	5
MPI_FREE_MEM, 356 , 357 , 368 , 428 , 429 , 656	MPI_GROUP_EXCL, 247 , 247 , 249	6
MPI_GATHER, 151 , 154–156 , 160 , 162 , 163 , 171 , 177 , 187 , 214	MPI_GROUP_F2C, 698	7
MPI_GATHERV, 151 , 155 , 156 , 162 , 162 , 163 , 164 , 172 , 178 , 179 , 215	MPI_GROUP_FREE, 249 , 250 , 251 , 360 , 874	8
MPI_GET, 423 , 437 , 438 , 440 , 441 , 447 , 452 , 457 , 479 , 481 , 482 , 688 , 875	MPI_GROUP_INCL, 246 , 247 , 248	9
MPI_GET_ACCUMULATE, 424 , 437 , 445 , 446 , 447 , 455 , 482 , 488 , 489	MPI_GROUP_INTERSECTION, 245	10
MPI_GET_ADDRESS, 19 , 93 , 110 , 111 , 111 , 112 , 123 , 432 , 623 , 656 , 658 , 678 , 683 , 684 , 703–705	MPI_GROUP_RANGE_EXCL, 248 , 249	11
MPI_GET_COUNT, 35 , 35 , 36 , 58 , 121 , 122 , 450 , 503 , 504 , 532 , 863 , 872	MPI_GROUP_RANGE_INCL, 247 , 248	12
MPI_GET_ELEMENTS, 58 , 121 , 121 , 122 , 503 , 504 , 532 , 863	MPI_GROUP_RANK, 242 , 251	13
MPI_GET_ELEMENTS_X, 58 , 121 , 121 , 122 , 503 , 504 , 863	MPI_GROUP_SIZE, 242 , 250	14
MPI_GET_LIBRARY_VERSION, 352 , 352 , 353 , 375 , 378 , 862	MPI_GROUP_TRANSLATE_RANKS, 243 , 243 , 873	15
MPI_GET_PROCESSOR_NAME, 354 , 355 , 874	MPI_GROUP_UNION, 245	16
MPI_GET_VERSION, 352 , 352 , 353 , 375 , 378 , 662	MPI_IALLGATHER, 151 , 155 , 156 , 217	17
MPI_GRAPH_CREATE, 304 , 305 , 308 , 309 , 310 , 315 , 318 , 321 , 322 , 329 , 330 , 873	MPI_IALLGATHERV, 151 , 155 , 156 , 218	18
MPI_GRAPH_GET, 305 , 318 , 318	MPI_IALLREDUCE, 151 , 155 , 156 , 224	19
MPI_GRAPH_MAP, 306 , 329 , 329	MPI_IALLTOALL, 151 , 155 , 156 , 219	20
MPI_GRAPH_NEIGHBORS, 305 , 306 , 321 , 321 , 322 , 330 , 871	MPI_IALLTOALLV, 151 , 155 , 156 , 220	21
MPI_GRAPH_NEIGHBORS_COUNT, 305 , 321 , 321 , 322 , 871	MPI_IALLTOALLW, 151 , 155 , 156 , 222	22
MPI_GRAPHDIMS_GET, 305 , 317 , 318	MPI_IBARRIER, 151 , 155 , 156 , 210 , 211 , 212	23
MPI_GREQUEST_COMPLETE, 496–499 , 499 , 500	MPI_Ibarrier, 232	24
	MPI_IBCAST, 151 , 155 , 156 , 212 , 213 , 236	25
	MPI_IBSEND, 55 , 59 , 85	26
	MPI_IEXSCAN, 152 , 155 , 228	27
	MPI_IGATHER, 151 , 155 , 156 , 213	28
	MPI_IGATHERV, 151 , 155 , 156 , 214	29
	MPI_IMPROBE, 71 , 74 , 75 , 75 , 76 , 78 , 861 , 866	30
	MPI_IMRECV, 74–76 , 78 , 78	31
	MPI_INEIGHBOR_ALLGATHER, 306 , 340 , 863	32
	MPI_INEIGHBOR_ALLGATHERV, 306 , 341 , 863	33
	MPI_INEIGHBOR_ALLTOALL, 306 , 342 , 863	34
	MPI_INEIGHBOR_ALLTOALLV, 306 , 343 , 863	35
	MPI_INEIGHBOR_ALLTOALLW, 306 , 344 , 863	36
	MPI_INFO_C2F, 698	37
	MPI_INFO_CREATE, 386 , 386	38

- 1 MPI_INFO_DELETE, [368](#), [387](#), [387](#), [389](#)
2 MPI_INFO_DUP, [389](#), [390](#)
3 MPI_INFO_F2C, [698](#)
4 MPI_INFO_FREE, [390](#), [524](#)
5 MPI_INFO_GET, [385](#), [387](#), [875](#)
6 MPI_INFO_GET_NKEYS, [385](#), [388](#), [389](#),
7 [875](#)
8 MPI_INFO_GET_NTHKEY, [385](#), [389](#),
9 [875](#)
10 MPI_INFO_GET_VALUELEN, [385](#), [388](#),
11 [875](#)
12 MPI_INFO_SET, [386](#), [386](#), [388](#), [389](#)
13 MPI_INIT, [15](#), [25](#), [241](#), [352](#), [353](#), [375](#), [375](#),
14 [378–381](#), [395–397](#), [399](#), [416](#), [417](#),
15 [507–510](#), [589](#), [592](#), [595–597](#), [601](#),
16 [614](#), [696](#), [697](#), [701](#), [863](#), [865](#), [870](#),
17 [871](#)
18 MPI_INIT_THREAD, [241](#), [375](#), [380](#), [508](#),
19 [508](#), [509](#), [510](#), [595](#), [696](#), [862](#), [865](#),
20 [871](#)
21 MPI_INITIALIZED, [375](#), [378](#), [379](#), [379](#),
22 [381](#), [510](#), [697](#)
23 MPI_INTERCOMM_CREATE, [252](#), [272](#),
24 [273](#), [274](#), [864](#)
25 MPI_INTERCOMM_MERGE, [269](#), [272](#),
26 [274](#), [274](#), [867](#)
27 MPI_IPROBE, [36](#), [71](#), [71](#), [72–76](#), [78](#), [506](#),
28 [861](#), [866](#)
29 MPI_Irecv, [57](#), [78](#), [677](#), [678](#), [681–683](#)
30 MPI_IREDUCE, [151](#), [155](#), [156](#), [223](#), [224](#)
31 MPI_IREDUCE_SCATTER, [151](#), [155](#),
32 [156](#), [226](#)
33 MPI_IREDUCE_SCATTER_BLOCK,
34 [151](#), [155](#), [156](#), [225](#)
35 MPI_IRSEND, [56](#)
36 MPI_IS_THREAD_MAIN, [508](#), [510](#)
37 MPI_ISCAN, [152](#), [155](#), [227](#)
38 MPI_ISCATTER, [151](#), [155](#), [156](#), [215](#)
39 MPI_ISCATTERV, [151](#), [155](#), [156](#), [216](#)
40 MPI_ISEND, [11](#), [54](#), [84](#), [376](#), [656](#), [657](#),
41 [676](#), [677](#), [683](#)
42 MPI_ISSEND, [55](#)
43 MPI_KEYVAL_CREATE, [19](#), [280](#), [282](#),
44 [624](#), [626](#), [737](#)
45 MPI_KEYVAL_FREE, [19](#), [283](#), [293](#), [625](#)
46 MPI_LOOKUP_NAME, [368](#), [406](#), [411](#),
47 [412](#), [413](#)
48 MPI_MESSAGE_C2F, [698](#), [862](#)
MPI_MESSAGE_F2C, [698](#), [862](#)
MPI_MPROBE, [71](#), [74–76](#), [76](#), [78](#), [861](#),
[866](#)
MPI_MRECV, [74–77](#), [77](#), [78](#), [862](#)
MPI_NEIGHBOR_ALLGATHER, [306](#),
[331](#), [332](#), [334](#), [340](#), [863](#)
MPI_NEIGHBOR_ALLGATHERV, [306](#),
[333](#), [341](#), [863](#)
MPI_NEIGHBOR_ALLTOALL, [306](#), [334](#),
[335](#), [342](#), [863](#)
MPI_NEIGHBOR_ALLTOALLV, [306](#),
[336](#), [343](#), [863](#)
MPI_NEIGHBOR_ALLTOALLW, [306](#),
[337](#), [338](#), [345](#), [863](#)
MPI_NULL_COPY_FN, [19](#), [281](#), [625](#), [647](#)
MPI_NULL_DELETE_FN, [19](#), [282](#), [625](#)
MPI_OP_C2F, [698](#)
MPI_OP_COMMUTATIVE, [202](#), [870](#)
MPI_OP_CREATE, [195](#), [195](#), [197](#), [656](#),
[734](#), [866](#)
MPI_Op_create, [731](#)
MPI_OP_F2C, [698](#)
MPI_OP_FREE, [198](#)
MPI_OPEN_PORT, [406](#), [407](#), [407](#),
[409–411](#), [413](#)
MPI_PACK, [52](#), [141](#), [144](#), [147](#), [563](#), [566](#),
[567](#)
MPI_PACK_EXTERNAL, [8](#), [147](#), [148](#),
[669](#), [873](#)
MPI_PACK_EXTERNAL_SIZE, [149](#)
MPI_PACK_SIZE, [52](#), [144](#), [144](#), [863](#)
MPI_PCONTROL, [587](#), [588](#), [588](#), [589](#)
MPI_PROBE, [33](#), [36](#), [37](#), [71](#), [72](#), [72](#),
[73–76](#), [78](#), [506](#), [861](#), [866](#)
MPI_PUBLISH_NAME, [406](#), [410](#), [411–413](#)
MPI_PUT, [423](#), [437](#), [438](#), [438](#), [441](#), [445](#),
[451](#), [457](#), [462](#), [468](#), [472](#), [475](#), [480](#),
[481](#), [676](#), [688](#), [875](#)
MPI_QUERY_THREAD, [510](#), [511](#)
MPI_RACCUMULATE, [424](#), [437](#), [445](#),
[447](#), [452](#), [453](#)
MPI_RECV, [28](#), [32](#), [34](#), [36](#), [37](#), [72](#), [74](#), [75](#),
[92](#), [120](#), [142](#), [143](#), [152](#), [161](#), [504](#),
[575](#), [614](#), [633](#), [683](#), [687–689](#)
MPI_Recv, [233](#)
MPI_RECV_INIT, [83](#), [84](#)
MPI_REDUCE, [151](#), [155](#), [156](#), [186](#), [186](#),
[187](#), [188](#), [195–197](#), [200](#), [203](#),

205–207, 224, 445, 447–449, 872	MPI_STATUS_SET_CANCELLED, 504	1
MPI_REDUCE_LOCAL, 187 , 188 , 195 ,	MPI_STATUS_SET_ELEMENTS, 503 ,	2
201 , 867 , 870	504	3
MPI_REDUCE_SCATTER, 151 , 155 , 156 ,	MPI_STATUS_SET_ELEMENTS_X, 503 ,	4
188 , 195 , 204 , 204 , 205 , 227	504 , 863	5
MPI_REDUCE_SCATTER_BLOCK, 151 ,	MPI_T_CATEGORY_CHANGED, 619	6
155 , 156 , 188 , 195 , 203 , 203 , 204 ,	MPI_T_CATEGORY_GET_CATEGORIES,	7
226 , 871	618 , 618 , 619	8
MPI_REGISTER_DATAREP, 369 , 563 ,	MPI_T_CATEGORY_GET_CVARS, 618 ,	9
565 , 566 , 568 , 580 , 656 , 736	618 , 619	10
MPI_Register_datarep, 733	MPI_T_CATEGORY_GET_INFO, 617 ,	11
MPI_Request, 676	619	12
MPI_REQUEST_C2F, 698	MPI_T_CATEGORY_GET_NUM, 617	13
MPI_REQUEST_F2C, 698	MPI_T_CATEGORY_GET_PVARS, 618 ,	14
MPI_REQUEST_FREE, 23 , 60 , 61 , 79 , 85 ,	618 , 619	15
210 , 376 , 377 , 450 , 498 , 500 , 870	MPI_T_CVAR_GET_INFO, 597 , 599 ,	16
MPI_REQUEST_GET_STATUS, 37 , 70 ,	599 , 600 , 602 , 603 , 619	17
71 , 497 , 870	MPI_T_CVAR_GET_NUM, 599 , 602	18
MPI_RGET, 423 , 437 , 451 , 452	MPI_T_CVAR_HANDLE_ALLOC, 602 ,	19
MPI_RGET_ACCUMULATE, 424 , 437 ,	602 , 603	20
445 , 447 , 454 , 455	MPI_T_CVAR_HANDLE_FREE, 602 , 602	21
MPI_RPUT, 423 , 437 , 450 , 451	MPI_T_CVAR_READ, 603	22
MPI_RSEND, 44	MPI_T_CVAR_WRITE, 603	23
MPI_RSEND_INIT, 83	MPI_T_ENUM_GET_INFO, 597 , 597	24
MPI_SCAN, 152 , 155 , 188 , 195 , 206 , 206 ,	MPI_T_ENUM_GET_ITEM, 597 , 598	25
208 , 227	MPI_T_ENUMITEM, 620	26
MPI_SCATTER, 151 , 155 , 156 , 170 ,	MPI_T_FINALIZE, 596 , 596	27
171–173 , 203 , 216	MPI_T_INIT_THREAD, 595 , 595 , 596	28
MPI_SCATTERV, 151 , 155 , 156 , 172 , 172 ,	MPI_T_PVAR_GET_INFO, 597 , 606–608 ,	29
173 , 174 , 205 , 217	608 , 610 , 612 , 613 , 619	30
MPI_SEND, 27 , 28 , 29 , 36 , 39 , 92 , 119 ,	MPI_T_PVAR_GET_NUM, 607 , 610	31
141 , 345 , 516 , 575 , 589 , 633 ,	MPI_T_PVAR_HANDLE_ALLOC, 610 ,	32
654–657 , 675 , 683 , 684 , 687 , 688	610 , 612	33
MPI_Send, 233	MPI_T_PVAR_HANDLE_FREE, 611 , 611	34
MPI_SEND_INIT, 81 , 84	MPI_T_PVAR_READ, 612 , 612 , 613	35
MPI_SENDRECV, 86 , 325	MPI_T_PVAR_READRESET, 609 , 613 ,	36
MPI_SENDRECV_REPLACE, 88	613 , 620	37
MPI_SIZEOF, 646 , 648 , 670 , 670 , 671	MPI_T_PVAR_RESET, 613 , 613 , 620	38
MPI_SSEND, 44	MPI_T_PVAR_SESSION_CREATE, 609	39
MPI_SSEND_INIT, 82	MPI_T_PVAR_SESSION_FREE, 609	40
MPI_START, 84 , 84 , 85	MPI_T_PVAR_START, 611 , 620	41
MPI_STARTALL, 85 , 85	MPI_T_PVAR_STOP, 611 , 620	42
MPI_STATUS_C2F, 701	MPI_T_PVAR_WRITE, 612 , 612 , 620	43
MPI_STATUS_C2F08, 701 , 866	MPI_TEST, 11 , 37 , 58 , 59 , 60–62 , 65 , 79 ,	44
MPI_STATUS_F082C, 701 , 866	85 , 376 , 377 , 499 , 500 , 530 , 531	45
MPI_STATUS_F082F, 703 , 866	MPI_TEST_CANCELLED, 58–60 , 79 , 80 ,	46
MPI_STATUS_F2C, 700	497 , 504 , 532	47
MPI_STATUS_F2F08, 702 , 866		48

- 1 MPI_TESTALL, [63](#), [66](#), [67](#), [497–499](#), [502](#),
2 [506](#)
- 3 MPI_TESTANY, [58](#), [63](#), [64](#), [65](#), [69](#),
4 [497–499](#), [502](#), [506](#)
- 5 MPI_TESTSOME, [63](#), [68](#), [69](#), [497–499](#),
6 [502](#), [506](#)
- 7 MPI_TOPO_TEST, [305](#), [317](#), [317](#)
- 8 MPI_TYPE_C2F, [698](#)
- 9 MPI_TYPE_COMMIT, [117](#), [118](#), [698](#)
- 10 MPI_TYPE_CONTIGUOUS, [12](#), [93](#), [93](#),
11 [95](#), [113](#), [125](#), [514](#), [561](#)
- 12 MPI_TYPE_CREATE_DARRAY, [12](#), [36](#),
13 [106](#), [107](#), [125](#)
- 14 MPI_TYPE_CREATE_F90_COMPLEX,
15 [12](#), [125](#), [127](#), [189](#), [563](#), [638](#), [646](#),
16 [649](#), [666](#), [668](#)
- 17 MPI_TYPE_CREATE_F90_INTEGER,
18 [12](#), [125](#), [127](#), [189](#), [563](#), [638](#), [646](#),
19 [648](#), [667](#), [668](#)
- 20 MPI_TYPE_CREATE_F90_REAL, [12](#),
21 [125](#), [127](#), [189](#), [563](#), [638](#), [646](#), [648](#),
22 [666](#), [666](#), [667](#), [668](#), [870](#)
- 23 MPI_TYPE_CREATE_HINDEXED, [12](#),
24 [19](#), [93](#), [99](#), [99](#), [101](#), [103](#), [125](#), [621](#)
- 25 MPI_TYPE_CREATE_HINDEXED_BLOCK,
26 [12](#), [93](#), [101](#), [101](#), [125](#), [864](#)
- 27 MPI_TYPE_CREATE_HVECTOR, [12](#),
28 [19](#), [93](#), [96](#), [96](#), [125](#), [621](#)
- 29 MPI_TYPE_CREATE_INDEXED_BLOCK,
30 [12](#), [100](#), [101](#), [125](#)
- 31 MPI_TYPE_CREATE_KEYVAL, [278](#),
32 [289](#), [293](#), [706](#), [735](#), [873](#)
- 33 MPI_Type_create_keyval, [732](#)
- 34 MPI_TYPE_CREATE_RESIZED, [18](#), [19](#),
35 [93](#), [115](#), [125](#), [561](#), [866](#)
- 36 MPI_TYPE_CREATE_STRUCT, [12](#), [19](#),
37 [93](#), [102](#), [103](#), [113](#), [125](#), [185](#), [622](#)
- 38 MPI_TYPE_CREATE_SUBARRAY, [12](#),
39 [15](#), [103](#), [105](#), [107](#), [125](#)
- 40 MPI_TYPE_DELETE_ATTR, [278](#), [292](#),
41 [293](#), [866](#)
- 42 MPI_TYPE_DUP, [12](#), [119](#), [119](#), [125](#), [866](#)
- 43 MPI_TYPE_DUP_FN, [290](#), [290](#), [723](#)
- 44 MPI_TYPE_EXTENT, [19](#), [114](#), [115](#), [623](#),
45 [706](#), [864](#)
- 46 MPI_TYPE_F2C, [698](#)
- 47 MPI_TYPE_FREE, [118](#), [127](#), [291](#)
- 48 MPI_TYPE_FREE_KEYVAL, [278](#), [291](#),
[293](#)
- MPI_TYPE_GET_ATTR, [278](#), [292](#), [293](#),
[707](#), [866](#)
- MPI_TYPE_GET_CONTENTS, [124](#), [125](#),
[126](#), [127–129](#)
- MPI_TYPE_GET_ENVELOPE, [124](#), [124](#),
[127](#), [128](#), [668](#)
- MPI_TYPE_GET_EXTENT, [19](#), [115](#),
[117](#), [623](#), [671](#), [703](#), [706](#)
- MPI_TYPE_GET_EXTENT_X, [863](#)
- MPI_TYPE_GET_NAME, [298](#), [866](#)
- MPI_TYPE_GET_TRUE_EXTENT, [116](#)
- MPI_TYPE_GET_TRUE_EXTENT_X,
[863](#)
- MPI_TYPE_HINDEXED, [19](#), [99](#), [125](#),
[126](#), [622](#), [706](#), [864](#)
- MPI_TYPE_HVECTOR, [19](#), [96](#), [125](#), [126](#),
[621](#), [706](#), [864](#)
- MPI_TYPE_INDEXED, [12](#), [97](#), [97](#),
[98–100](#), [125](#)
- MPI_TYPE_LB, [19](#), [114](#), [115](#), [623](#), [864](#)
- MPI_TYPE_MATCH_SIZE, [646](#), [648](#),
[670](#), [670](#), [671](#), [866](#)
- MPI_TYPE_NULL_COPY_FN, [290](#), [290](#),
[723](#)
- MPI_TYPE_NULL_DELETE_FN, [290](#),
[723](#), [866](#)
- MPI_TYPE_SET_ATTR, [278](#), [291](#), [293](#),
[707](#), [710](#), [866](#)
- MPI_TYPE_SET_NAME, [298](#), [866](#)
- MPI_TYPE_SIZE, [112](#), [112](#), [589](#), [863](#)
- MPI_TYPE_SIZE_X, [863](#)
- MPI_TYPE_STRUCT, [18](#), [19](#), [102](#), [113](#),
[125](#), [126](#), [622](#), [706](#), [864](#)
- MPI_TYPE_UB, [19](#), [114](#), [115](#), [624](#), [706](#),
[864](#)
- MPI_TYPE_VECTOR, [12](#), [94](#), [94](#), [95](#), [96](#),
[98](#), [125](#)
- MPI_UNPACK, [142](#), [143](#), [147](#), [567](#)
- MPI_UNPACK_EXTERNAL, [8](#), [149](#), [669](#)
- MPI_UNPUBLISH_NAME, [368](#), [412](#), [412](#)
- MPI_WAIT, [35](#), [37](#), [58](#), [58](#), [59–62](#), [64](#), [65](#),
[79](#), [85](#), [210](#), [376](#), [377](#), [495](#), [499](#),
[500](#), [506](#), [530](#), [531](#), [551](#), [569](#), [571](#),
[676](#), [682](#), [683](#), [687](#), [689](#)
- MPI_Wait, [233](#)
- MPI_WAITALL, [63](#), [65](#), [65](#), [66](#), [67](#), [210](#),
[450](#), [497–499](#), [502](#), [506](#), [641](#)

- MPI_WAITANY, [46](#), [58](#), [63](#), [63](#), [64](#), [69](#),
[497–499](#), [502](#), [506](#)
 MPI_WAITSOME, [63](#), [67](#), [68–70](#), [497–499](#),
[502](#), [506](#)
 MPI_WIN_ALLOC, [430](#)
 MPI_WIN_ALLOCATE, [424](#), [427](#), [428](#),
[435](#), [436](#), [439](#), [468](#), [656](#), [659–661](#)
 MPI_WIN_ALLOCATE_CPTR, [428](#)
 MPI_WIN_ALLOCATE_SHARED, [424](#),
[429](#), [429](#), [431](#), [436](#)
 MPI_WIN_ALLOCATE_SHARED_CPTR, [430](#)
 MPI_WIN_ATTACH, [432](#), [433](#), [433](#), [434](#),
[468](#)
 MPI_WIN_C2F, [698](#)
 MPI_WIN_CALL_ERRHANDLER, [372](#),
[373](#)
 MPI_WIN_COMPLETE, [435](#), [457](#), [462](#),
[462](#), [463–465](#), [474](#), [480](#), [481](#)
 MPI_WIN_CREATE, [424](#), [425](#), [427](#), [428](#),
[430](#), [432](#), [433](#), [435](#), [436](#), [472](#), [507](#)
 MPI_WIN_CREATE_DYNAMIC, [424](#),
[432](#), [432](#), [433](#), [435](#), [436](#), [439](#), [473](#)
 MPI_WIN_CREATE_ERRHANDLER,
[359](#), [360](#), [362](#), [363](#), [735](#), [866](#)
 MPI_Win_create_errhandler, [733](#)
 MPI_WIN_CREATE_KEYVAL, [278](#), [285](#),
[293](#), [706](#), [734](#), [873](#)
 MPI_Win_create_keyval, [732](#)
 MPI_WIN_DELETE_ATTR, [278](#), [289](#),
[293](#)
 MPI_WIN_DETACH, [432](#), [434](#), [434](#), [435](#)
 MPI_WIN_DUP_FN, [286](#), [286](#), [723](#)
 MPI_WIN_F2C, [698](#)
 MPI_WIN_FENCE, [435](#), [441](#), [457](#), [460](#),
[461](#), [471](#), [474](#), [475](#), [478](#), [483](#), [688](#)
 MPI_WIN_FLUSH, [430](#), [450](#), [451](#), [469](#),
[469](#), [474](#), [477](#), [489](#), [490](#)
 MPI_WIN_FLUSH_ALL, [450](#), [451](#), [469](#),
[469](#), [474](#), [477](#)
 MPI_WIN_FLUSH_LOCAL, [450](#), [469](#),
[470](#), [474](#)
 MPI_WIN_FLUSH_LOCAL_ALL, [450](#),
[470](#), [470](#), [474](#)
 MPI_WIN_FREE, [287](#), [419](#), [434](#), [435](#)
 MPI_WIN_FREE_KEYVAL, [278](#), [287](#), [293](#)
 MPI_WIN_GET_ATTR, [278](#), [288](#), [293](#),
[435](#), [707](#), [710](#)
 MPI_Win_get_attr, [435](#), [436](#)
 MPI_WIN_GET_ERRHANDLER, [359](#),
[364](#), [874](#)
 MPI_WIN_GET_GROUP, [436](#), [437](#)
 MPI_WIN_GET_INFO, [864](#)
 MPI_WIN_GET_NAME, [299](#)
 MPI_WIN_LOCK, [355](#), [426](#), [458](#), [466](#), [466](#),
[467](#), [468](#), [471](#), [474](#), [478–480](#)
 MPI_WIN_LOCK_ALL, [426](#), [458](#), [466](#),
[466](#), [467](#), [471](#), [474](#), [480](#), [489](#)
 MPI_WIN_NULL_COPY_FN, [286](#), [286](#),
[723](#)
 MPI_WIN_NULL_DELETE_FN, [286](#), [723](#)
 MPI_WIN_POST, [435](#), [457](#), [462](#), [463](#), [463](#),
[464](#), [465](#), [468](#), [471](#), [474](#), [481](#), [483](#)
 MPI_WIN_SET_ATTR, [278](#), [288](#), [293](#),
[707](#), [710](#)
 MPI_Win_set_attr, [435](#), [436](#)
 MPI_WIN_SET_ERRHANDLER, [359](#),
[363](#)
 MPI_WIN_SET_INFO, [864](#)
 MPI_WIN_SET_NAME, [299](#)
 MPI_WIN_SHARED_QUERY, [429](#), [430](#)
 MPI_WIN_SHARED_QUERY_CPTR,
[431](#)
 MPI_WIN_START, [457](#), [461](#), [462](#), [463](#),
[465](#), [471](#), [481](#), [488](#)
 MPI_WIN_SYNC, [470](#), [470](#), [474](#), [476](#), [480](#),
[489](#), [490](#)
 MPI_WIN_TEST, [464](#), [464](#), [465](#)
 MPI_WIN_UNLOCK, [355](#), [451](#), [458](#), [467](#),
[468](#), [474](#), [478](#), [479](#)
 MPI_WIN_UNLOCK_ALL, [451](#), [458](#), [467](#),
[474](#), [478](#), [489](#)
 MPI_WIN_WAIT, [435](#), [457](#), [463](#), [463](#), [464](#),
[465](#), [468](#), [474](#), [478](#), [480–482](#)
 MPI_WTICK, [23](#), [374](#), [375](#)
 MPI_WTIME, [23](#), [354](#), [374](#), [374](#), [375](#), [589](#),
[606](#)
 mpiexec, [376](#), [380](#), [381](#), [382](#), [509](#)
 mpirun, [381](#)
 PMPI_, [586](#)
 PMPI_SEND, [655](#)
 PMPI_WTICK, [23](#)
 PMPI_WTIME, [23](#)